

SOT-23 Plastic-Encapsulate Transistors

BC807^{*} TRANSISTOR (PNP)

FEATURE

- Ideally suited for automatic insertion
- Epitaxial planar die construction
- Complementary NPN type available(BC817)

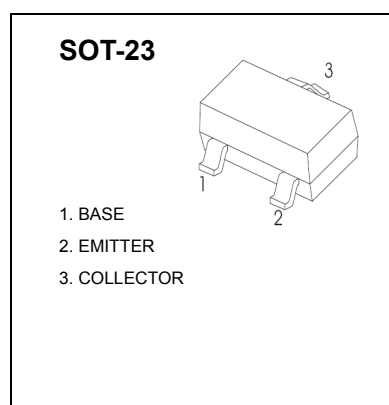

MAXIMUM RATINGS (T_a=25°C unless otherwise noted)

Symbol	Parameter	Value	Unit
V _{CBO}	Collector-Base Voltage	-50	V
V _{CEO}	Collector-Emitter Voltage	-45	V
V _{EBO}	Emitter-Base Voltage	-5	V
I _C	Collector Current -Continuous	-0.5	A
P _C	Collector Power Dissipation	0.3	W
T _j	Junction Temperature	150	°C
T _{stg}	Storage Temperature	-55-150	°C

ELECTRICAL CHARACTERISTICS (T_a=25°C unless otherwise specified)

Parameter	Symbol	Test conditions	Min	Max	Unit
Collector-base breakdown voltage	V _{CBO}	I _C = -10μA, I _E =0	-50		V
Collector-emitter breakdown voltage	V _{CEO}	I _C = -10mA, I _B =0	-45		V
Emitter-base breakdown voltage	V _{EBO}	I _E = -1μA, I _C =0	-5		V
Collector cut-off current	I _{CBO}	V _{CB} = -45V, I _E =0		-0.1	μA
Collector cut-off current	I _{CEO}	V _{CE} = -40V, I _B =0		-0.2	μA
Emitter cut-off current	I _{EBO}	V _{EB} = -4 V, I _C =0		-0.1	μA
DC current gain	h _{FE(1)}	V _{CE} = -1V, I _C = -100mA	100	600	
	h _{FE(2)}	V _{CE} = -1V, I _C = -500mA	40		
Collector-emitter saturation voltage	V _{CE(sat)}	I _C =-500mA, I _B = -50mA		-0.7	V
Base-emitter saturation voltage	V _{BE(sat)}	I _C = -500mA, I _B = -50mA		-1.2	V
Transition frequency	f _T	V _{CE} = -5V, I _C = -10mA f=100MHz	100		MHz

CLASSIFICATION OF h_{FE(1)}

Rank	BC807-16	BC807-25	BC807-40
Range	100-250	160-400	250-600
Marking	5A	5B	5C

SOT-23 Plastic-Encapsulate Transistors

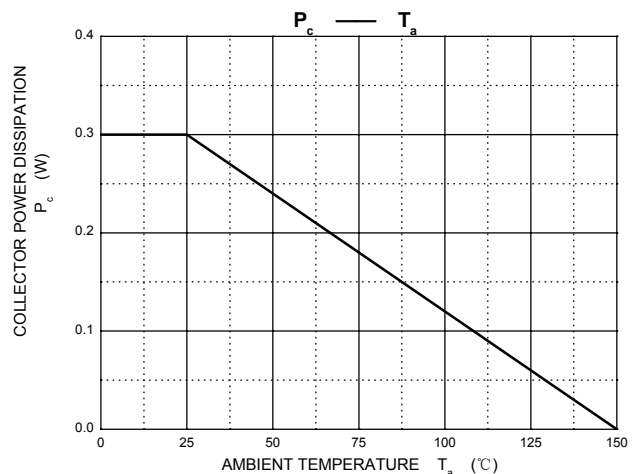
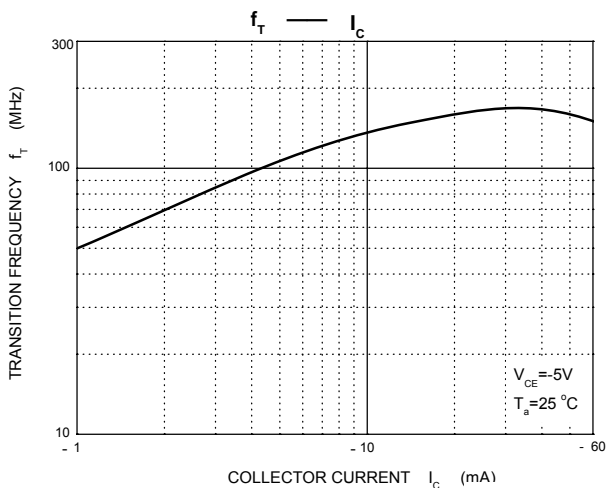
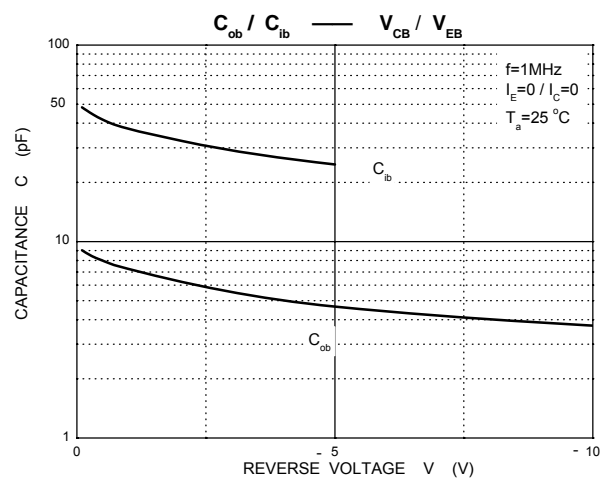
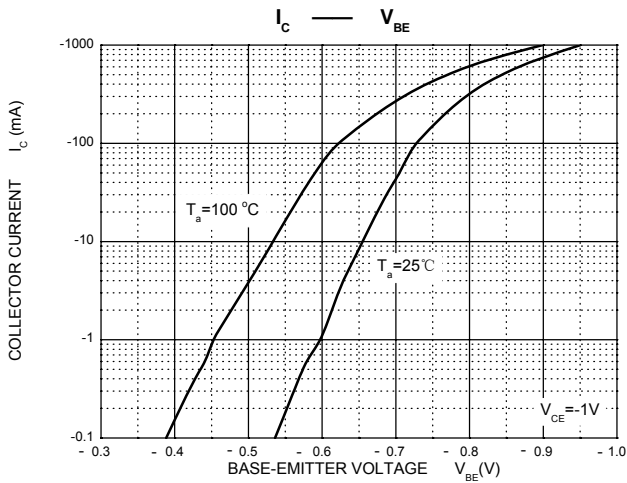
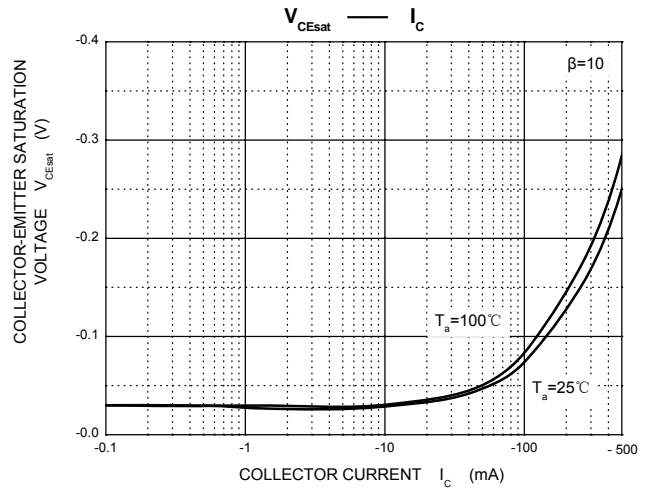
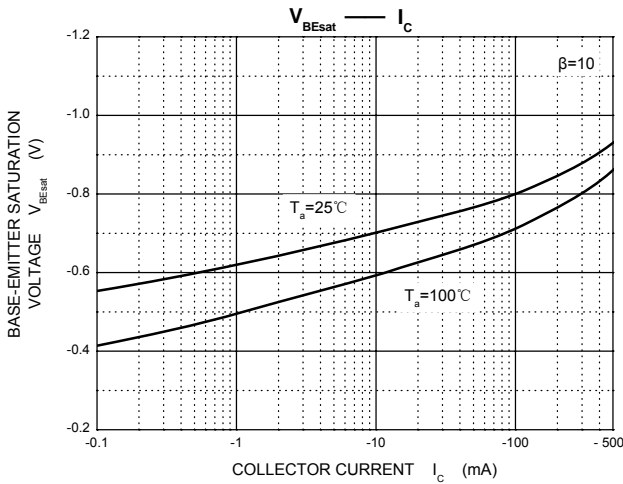
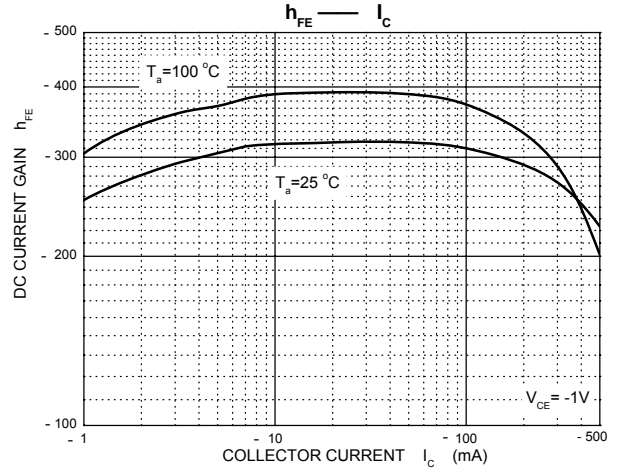
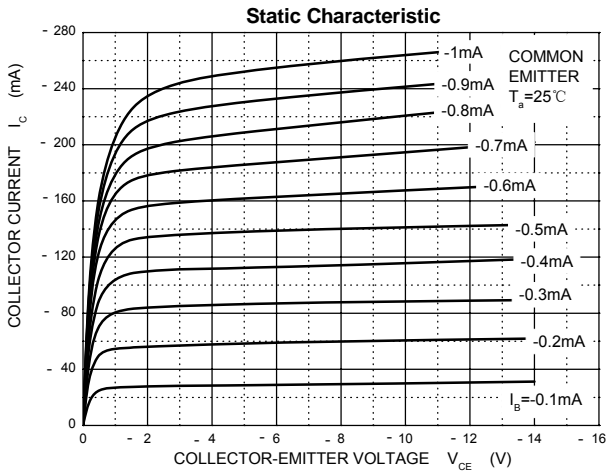

单击下面可查看定价，库存，交付和生命周期等信息

[>>UMW\(友台半导体\)](#)