

3A Fast-Response LDO Regulator

General Description

The MIC29302 is a high-current, low-cost, low-dropout voltage regulator which uses Micrel's proprietary Super beta PNP[®] process with a PNP pass element. The 3A LDO regulator features 450mV (full load) dropout voltage and very low ground current. Designed for high-current loads, these devices also find applications in lower current, low dropout-critical systems, where their dropout voltage and ground current values are important attributes.

Along with a total accuracy of ±2% (over temperature, line and load regulation) the regulator features very-fast transient recovery from input voltage surges and output load current changes.

The MIC29302 has an adjustable output which can be set by two external resistors to a voltage between 1.24V to 15V. In addition, the device is fully protected against over current faults, reversed input polarity, reversed lead insertion, and overtemperature operation. A TTL logic enable (EN) pin is available in the MIC29302 to shutdown the regulator. When not used, the device can be set to continuous operation by connecting EN to the input (IN). The MIC29302 is available in the standard and 5-pin TO-263 and TO-220 packages with an operating junction temperature range of -40°C to +85°C.

Applications

- Processor peripheral and I/O supplies
- High-efficiency “Green” computer systems
- Automotive electronics
- High-efficiency linear lower supplies
- Battery-powered equipment
- PC add-in cards
- High-efficiency lost-regulator for switching supply

Features

- High-current capability
 - 3A over full temperature range
- Low-dropout voltage of 450mV at full load
- Low ground current
- Accurate 1% guaranteed tolerance
- Extremely-fast transient response
- Zero-current shutdown mode
- Error flag signals output out-of-regulation
- Adjustable output voltage
- Packages: TO263-5 and TO220-5

Typical Application

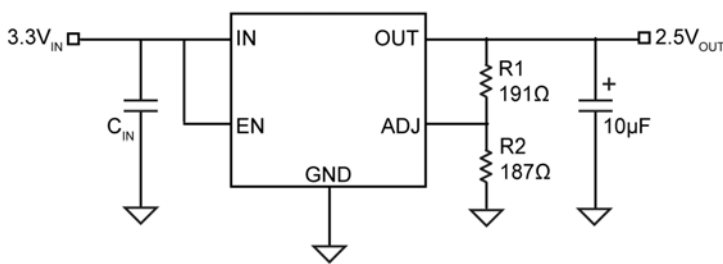

$$V_{OUT} = 1.242 \times \left(\frac{R1}{R2} + 1 \right)$$

MIC29302 Adjustable Output Regulator

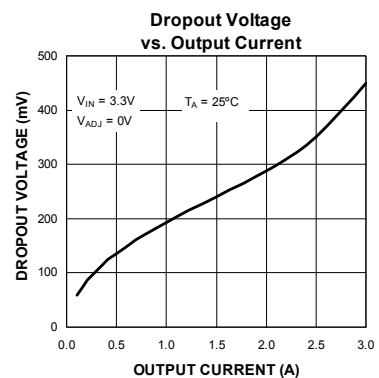

3A Fast-Response LDO Regulator

Pin Configuration

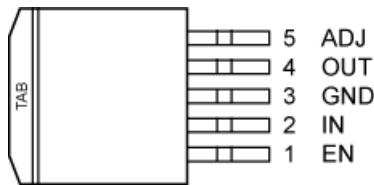

5-Pin TO-263 (D²Pak) Adjustable Voltage(U)

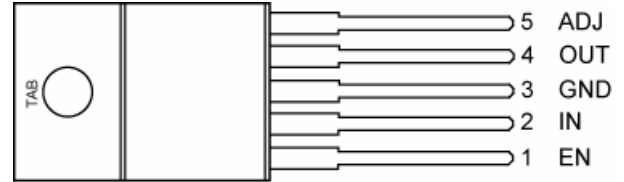

5-Pin TO-220 Adjustable Voltage (T)

Pin Description

Pin Number TO-263	Pin Number TO-220	Pin Name	Pin Name
1	1	EN	Enable (Input): Active-high CMOS compatible control input. Do not float.
2	2	IN	INPUT: Unregulated input, +2.8V to +16V maximum
3, TAB	3, TAB	GND	GND: TAB is also connected internally to the IC's ground on both packages.
4	4	OUT	OUTPUT: The regulator output voltage
5	5	ADJ	Feedback Voltage: 1.24V feedback from external resistor divider.

Absolute Maximum Ratings⁽¹⁾

Input Supply Voltage (V_{IN})⁽¹⁾ -20V to +20V
 Enable Input Voltage (V_{EN})..... -0.3V to V_{IN}
 Lead Temperature (soldering, 5sec.)..... 260°C
 Power Dissipation Internally Limited
 Storage Temperature Range -65°C to +150°C
 ESD Rating all pins⁽³⁾

Operating Ratings⁽²⁾

Operating Junction Temperature -40°C to +125°C
 Operating Input Voltage 3V to 16V
 Package Thermal Resistance
 TO-263 (θ_{JC})..... 3°C/W
 TO-220 (θ_{JC})..... 2°C/W

3A Fast-Response LDO Regulator

Electrical Characteristics⁽⁴⁾

$V_{IN} = 4.2V$; $I_{OUT} = 100mA$; $T_A = 25^{\circ}C$, **bold** values indicate $-40^{\circ}C \leq T_J \leq +125^{\circ}C$, unless noted.

Parameter	Condition	Min.	Typ.	Max.	Units
Output Voltage					
Output Voltage Accuracy	$100mA \leq I_{OUT} \leq 3A$, $(V_{OUT} + 1V) \leq V_{IN} \leq 16V$	-2		2	%
Line Regulation	$I_{OUT} = 100mA$, $(V_{OUT} + 1V) \leq V_{IN} \leq 16V$		0.1	0.5	%
Load Regulation	$V_{IN} = V_{OUT} + 1V$, $100mA \leq I_{OUT} \leq 3A$		0.2	1	%
Dropout Voltage	$\Delta V_{OUT} = -1\%^{(6)}$				mV
	$I_{OUT} = 100mA$		80	200	
	$I_{OUT} = 750mA$		220		
	$I_{OUT} = 1.5A$		275		
	$I_{OUT} = 3A$	3A	450	800	
Ground Current					
Ground Current	$I_{OUT} = 750mA$, $V_{IN} = V_{OUT} + 1V$		5	20	mA
	$I_{OUT} = 1.5A$		15		
	$I_{OUT} = 3A$		60	150	
I_{GRNDDO} Ground Pin Current @ Dropout	$V_{IN} = 0.5V$ less than specified $V_{OUT} \times I_{OUT} = 10mA$		2		
Current Limit	$V_{OUT} = 0V^{(7)}$	3	4		A
e_n , Output Noise Voltage (10Hz to 100kHz)	$C_L = 10\mu F$		400		μV (rms)
	$I_L = 100mA$		260		
Ground Pin Current in Shutdown	Input Voltage $V_{IN} = 16V$		32		μA

3A Fast-Response LDO Regulator

Electrical Characteristics⁽⁴⁾ (Continued)

$V_{IN} = 4.2V$; $I_{OUT} = 10mA$; $T_A = 25^{\circ}C$, **bold** values indicate $-40^{\circ}C \leq T_J \leq +125^{\circ}C$, unless noted.

Reference					
Reference Voltage	(8)	1.215		1.267	V
Adjust Pin Bias Current			40		nA
				120	
ENABLE Input					
Input Logic Voltage	Low (OFF)			0.8	V
	High (ON)	2.4			
Enable Pin Input Current	$V_{EN} = 8V$		15	30	μA
				75	
	$V_{EN} = 0.8V$			2	
				4	
Regulator Output Current in Shutdown	(10)		10		μA
				20	

Notes:

- Exceeding the absolute maximum rating may damage the device.
- The device is not guaranteed to function outside its operating rating.
- Devices are ESD sensitive. Handling precautions recommended. Human body model, 1.5k in series with 100pF.
- Specification for packaged product only
- Output voltage temperature coefficient is defined as the worst case voltage change divided by the total temperature change.
- Dropout voltage is defined as the input-to-output differential when output voltage drops to 99% of its normal value with $V_{OUT} + 1V$ applied to V_{IN} .
- $V_{IN} = V_{OUT(nominal)} + 1V$. For example, use $V_{IN} = 4.3V$ for a 3.3V regulator or use 6V for a 5V regulator. Employ pulse testing procedure for current limit.
- $V_{REF} \leq V_{OUT} \leq V_{IN} - 1$, $3V \leq V_{OUT} \leq 16V$, $10mA \leq I_L \leq I_{FL}$, $T_J \leq T_{Jmax}$
- Thermal regulation is defined as the change in the output voltage at a time T after a change in power dissipation is applied, excluding load or line regulation effects. Specifications are for a 250mA load pulse at $V_{IN} = 16V$ (a 4W pulse) for $T = 10ms$.
- $V_{EN} \leq 0.8V$, $V_{IN} \leq 16V$ and $V_{OUT} = 0V$.

Typical Characteristics

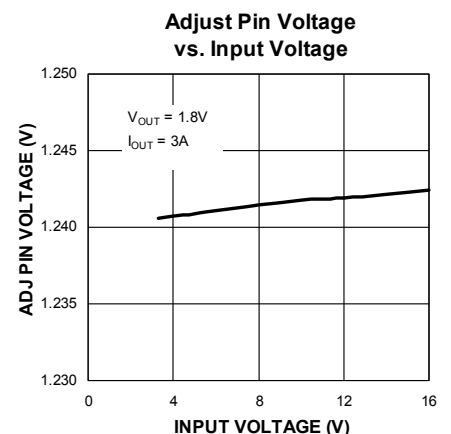
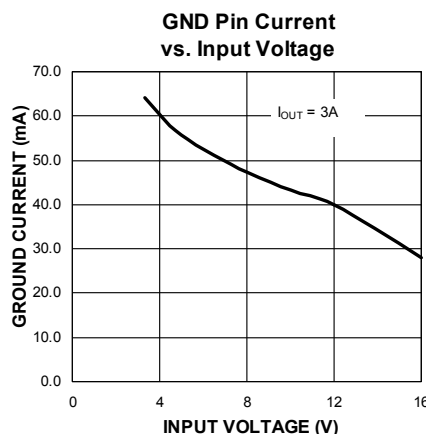
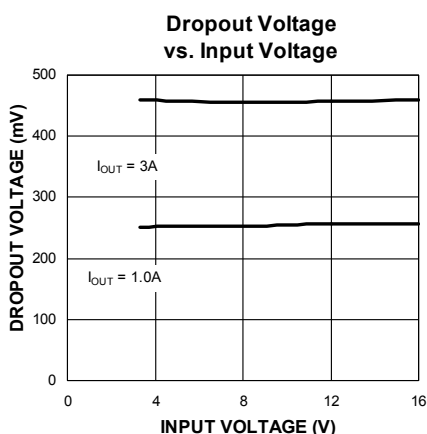

3A Fast-Response LDO Regulator

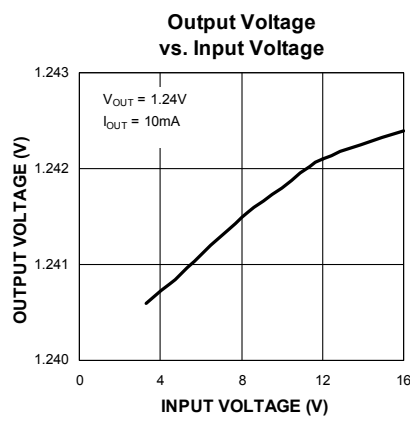
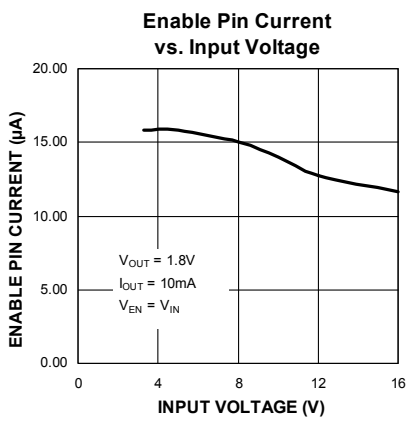
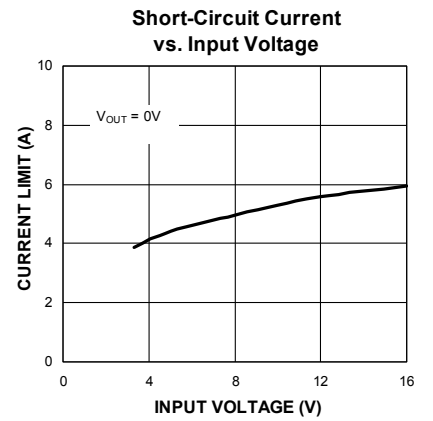
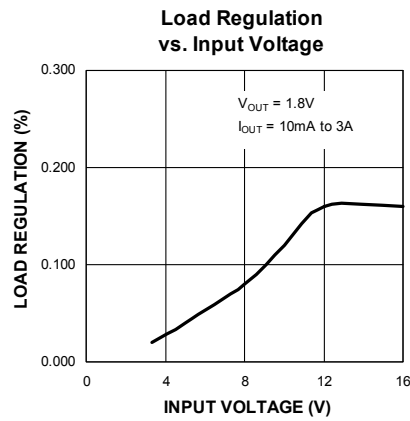
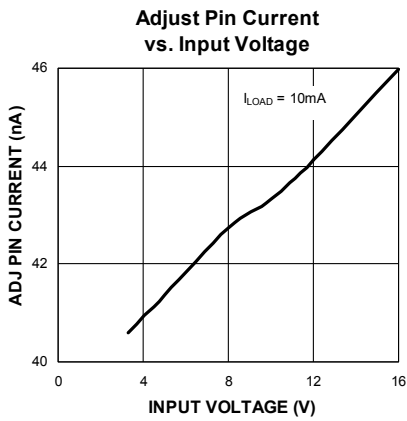

Typical Characteristics (Continued)

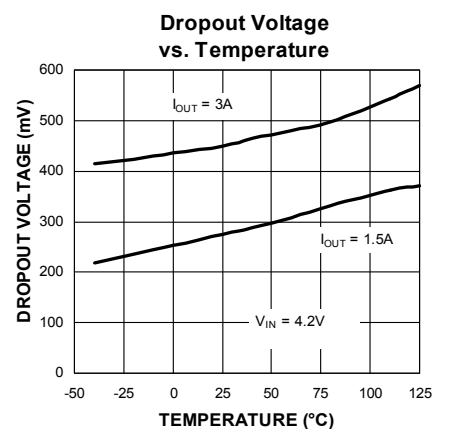
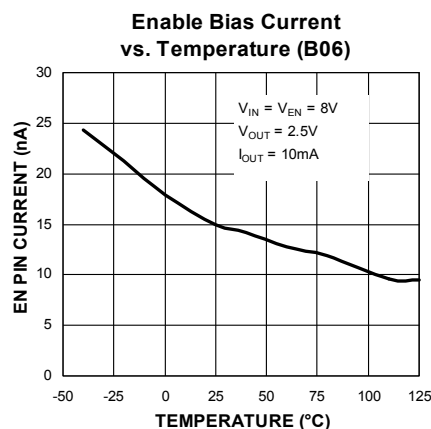
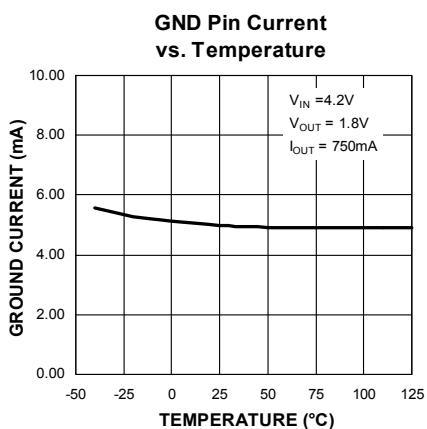

3A Fast-Response LDO Regulator

Dropout Voltage vs. Temperature

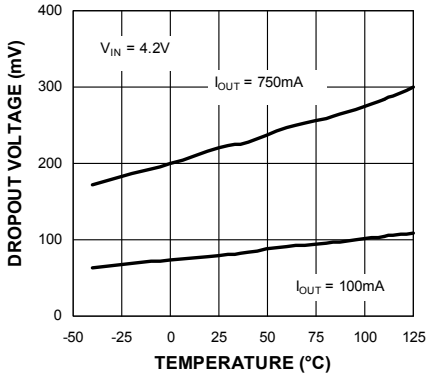

Short-Circuit Current vs. Temperature

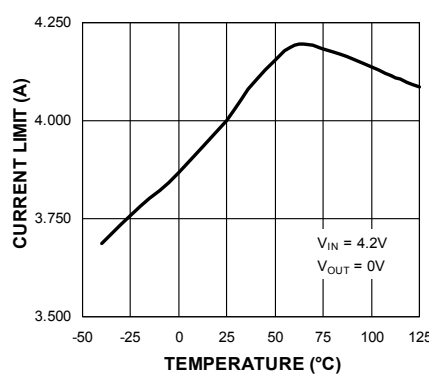

Adjust Pin Voltage vs. Temperature

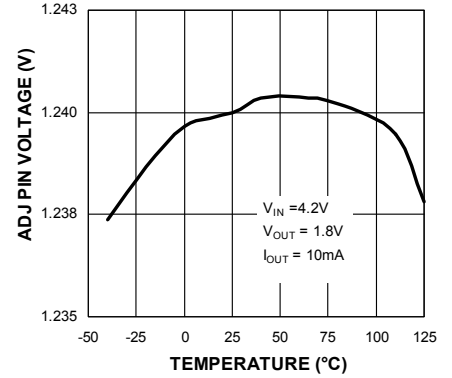

Adjust Pin Current vs. Temperature

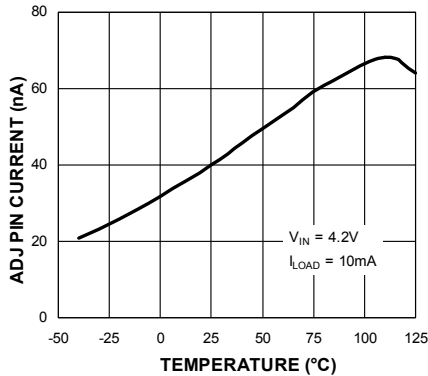

Line Regulation vs. Temperature

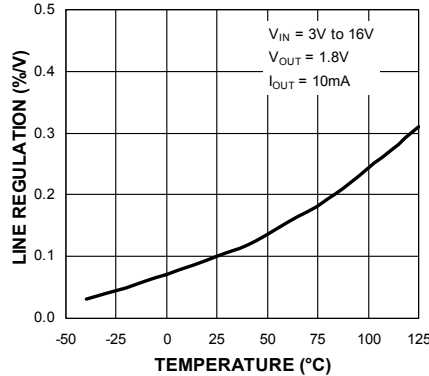

Typical Characteristics (Continued)

Dropout Voltage vs. Output Current

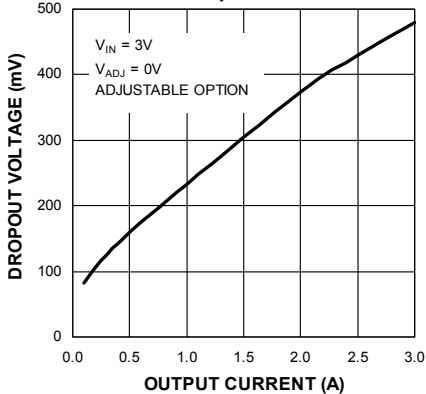

Dropout Voltage vs. Output Current

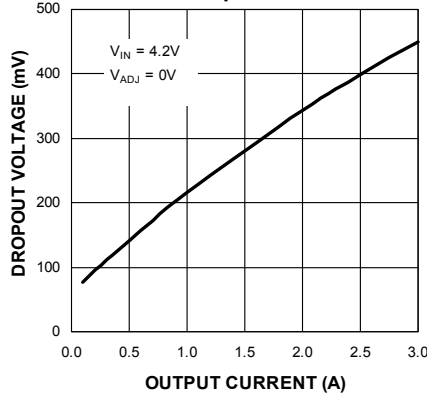

Adjust Pin Voltage vs. Output Current

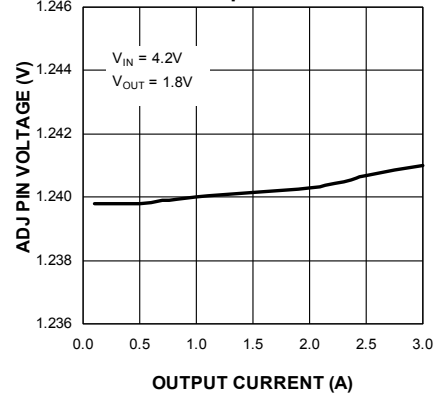

3A Fast-Response LDO Regulator

Line Regulation vs. Output Current

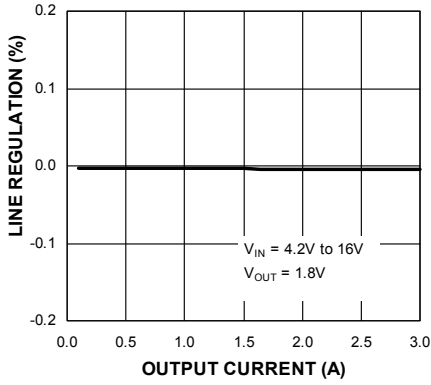

GND Pin Current vs. Output Current

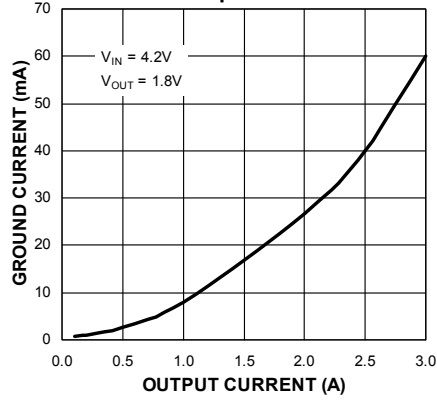

Output Noise vs. Frequency

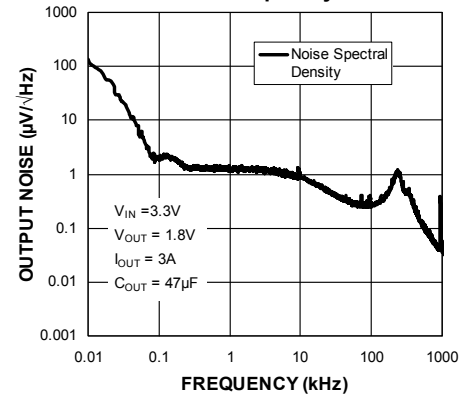

Ripple Rejection ($I_{OUT} = 10mA$) vs. Frequency

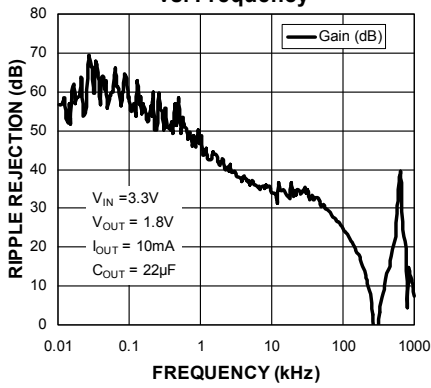

Ripple Rejection ($I_{OUT} = 1.5A$) vs. Frequency

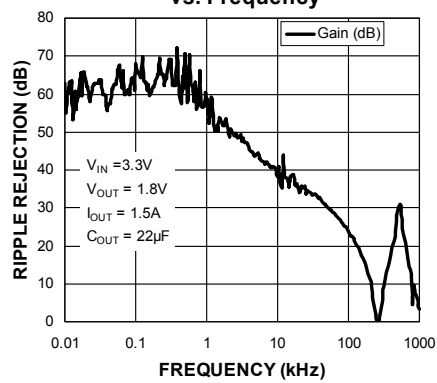

Ripple Rejection ($I_{OUT} = 3A$) vs. Frequency

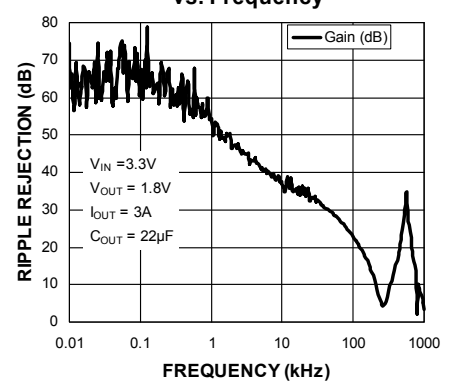

Functional Characteristics

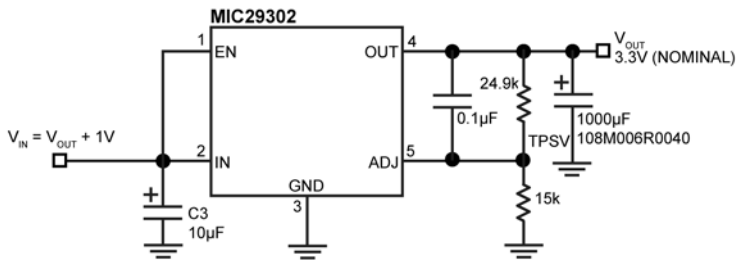
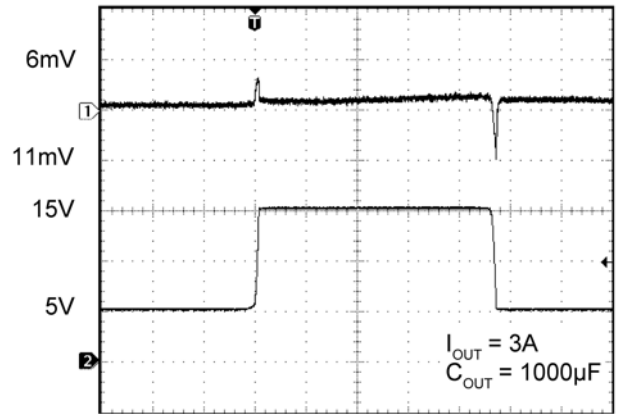

Figure 2. MIC29302 Load Transient Response Test Circuit

MIC29302 Line Transient Response with 3A Load, 1000µF Output Capacitance



Time (1.00ms/div)

MIC29302 Load Transient Response

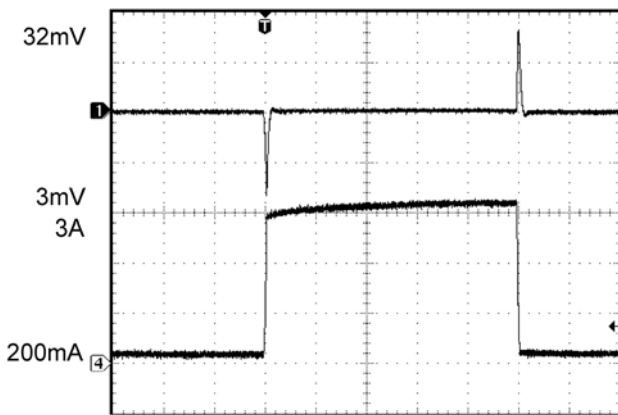

Time (1.00ms/div)

MIC29302 Line Transient Response with 3A Load, 10µF Output Capacitance

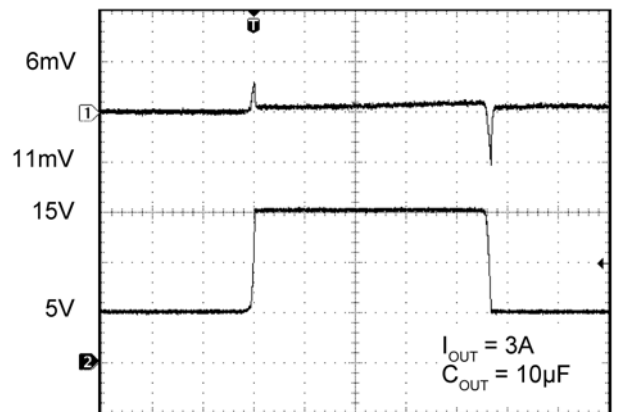

Time (1.00ms/div)

Functional Diagram

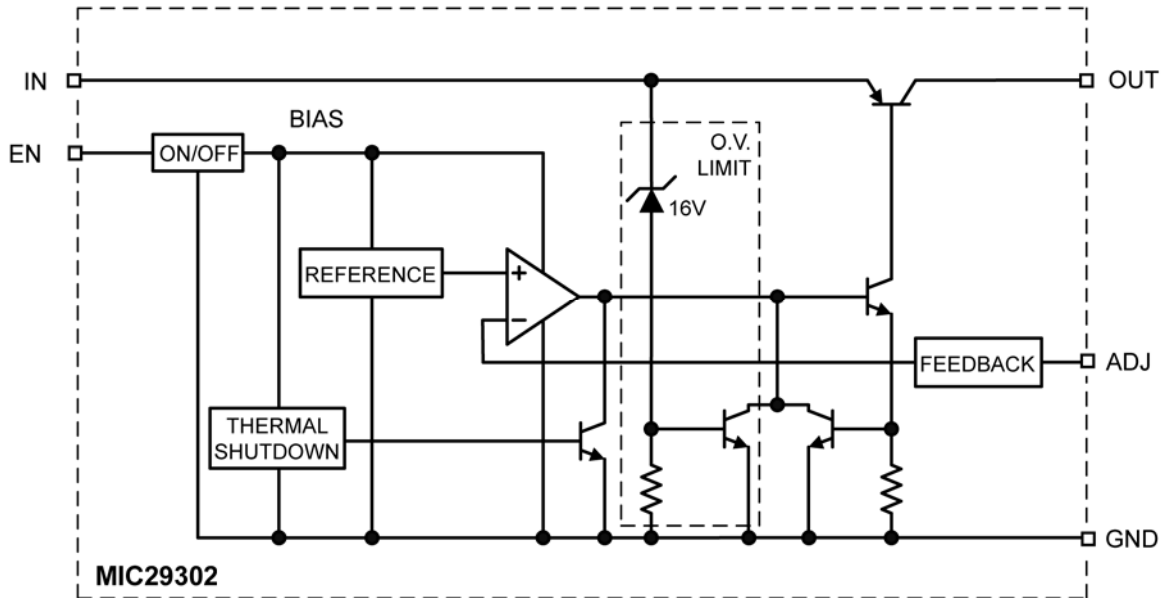

3A Fast-Response LDO Regulator

Application Information

The MIC29302 is a high-performance, low-dropout voltage regulator suitable for all moderate to high-current voltage regulation applications. Its 450mV typical dropout voltage at full load makes it especially valuable in battery-powered systems and as high efficiency noise filters in “post-regulator” applications. Unlike older NPN-pass transistor designs, where the minimum dropout voltage is limited by the base-emitter voltage drop and collector-emitter saturation voltage, dropout performance of the PNP output is limited merely by the low V_{CE} saturation voltage.

A trade-off for the low-dropout voltage is a varying base driver requirement. But Micrel’s Super β PNP[®] process reduces this drive requirement to merely 1% of the load current.

The MIC29302 regulator is fully protected from damage due to fault conditions. Current limiting is linear; output current under overload conditions is constant. Thermal shutdown disables the device when the die temperature exceeds the 125°C maximum safe operating temperature. The output structure of the regulators allows voltages in excess of the desired output voltage to be applied without reverse current flow. The MIC29302 offer a logic level ON/OFF control: when disabled, the devices draw nearly zero current.

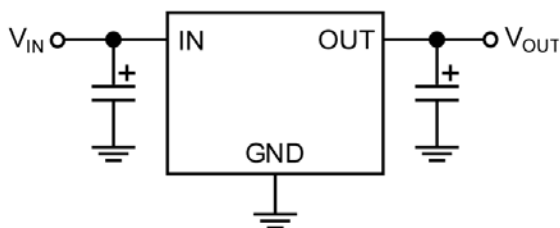

Figure 3. Linear Regulators Require Only Two Capacitors for Operation

First, we calculate the power dissipation of the regulator from these numbers and the device parameters from this datasheet:

$$P_D = I_{OUT}(1.02V_{IN} - V_{OUT})$$

Where the ground current is approximated by 2% of I_{OUT} . Then the heat sink thermal resistance is determined with this formula:

$$\theta_{SA} = \frac{T_{JMAX} - T_A}{P_D} - (\theta_{JC} + \theta_{CS})$$

where:

$T_{JMAX} \leq 125^\circ\text{C}$ and θ_{CS} is between 0 and 2°C/W .

The heat sink may be significantly reduced in applications where the minimum input voltage is known and is large compared to the dropout voltage. A series input resistor can be used to drop excessive voltage and distribute the heat between this resistor and the regulator. The low-dropout properties of Micrel Super β PNP[®] regulators allow very significant reductions in regulator power dissipation and the associated heat sink without compromising performance. When this technique is employed, a capacitor of at least $0.1\mu\text{F}$ is needed directly between the input and regulator ground.

With no heat sink in the application, calculate the junction temperature to determine the maximum power dissipation that will be allowed before exceeding the maximum junction temperature of the MIC29302.

Thermal Design

Linear regulators are simple to use. The most complicated set of design parameters to consider are thermal characteristics. Thermal design requires the following application-specific parameters:

- Maximum ambient temperature, T_A
- Output Current, I_{OUT}
- Output Voltage, V_{OUT}
- Input Voltage, V_{IN}

3A Fast-Response LDO Regulator

Next, calculate the junction temperature for the expected power dissipation:

$$T_J = (\theta_{JA} \times P_D) + T_A = (35^\circ\text{C/W} \times 2.3472\text{W}) + 75^\circ\text{C} = 157.15^\circ\text{C}$$

Now determine the maximum power dissipation allowed that would not exceed the IC's maximum junction temperature (125°C) without the use of a heat sink by:

$$\begin{aligned} P_{D(\text{MAX})} &= (T_{J(\text{MAX})} - T_A) / \theta_{JA} \\ &= (125^\circ\text{C} - 75^\circ\text{C}) / (35^\circ\text{C/W}) \\ &= 1.428\text{W} \end{aligned}$$

Capacitor Requirements

For stability and minimum output noise, a capacitor on the regulator output is necessary. The value of this capacitor is dependent upon the output current; lower currents allow smaller capacitors. The MIC29302 is stable with a 10µF capacitor at full load.

This capacitor need not be an expensive low-ESR type; aluminum electrolytics are adequate. In fact, extremely low-ESR capacitors may contribute to instability. Tantalum capacitors are recommended for systems where fast load transient response is important.

When the regulator is powered from a source with high AC impedance, a 0.1µF capacitor connected between input and GND is recommended.

Transient Response and 5V to 3.3V Conversion

The MIC29302 has excellent response to variations in input voltage and load current. By virtue of its low dropout voltage, the device does not saturate into dropout as readily as similar NPN-based designs. A 3.3V output Micrel LDO will maintain full speed and performance with an input supply as low as 4.2V, and will still provide some regulation with supplies down to 3.8V, unlike NPN devices that require 5.1V or more for good performance and become nothing more than a resistor under 4.6V of input. Micrel's PNP regulators provide superior performance in "5V to 3.3V" conversion applications than NPN regulators, especially when all tolerances are considered.

Minimum Load Current

The MIC29302 regulator operates within a specified load range. If the output current is too small, leakage currents dominate and the output voltage rises.

A minimum load current of 10mA is necessary for proper regulation and to swamp any expected leakage current across the operating temperature range.

For best performance the total resistance (R1+R2) should be small enough to pass the minimum regulator load current of 10mA.

Adjustable Regulator Design

The output voltage can be programmed anywhere between 1.25V and the 15V. Two resistors are used. The resistor values are calculated by:

$$R_1 = R_2 \times \left(\frac{V_{\text{OUT}}}{1.240} - 1 \right)$$

where V_{OUT} is the desired output voltage.

Figure 4 shows component definition. Applications with widely varying load currents may scale the resistors to draw the minimum load current required for proper operation (see "Minimum Load Current" section).

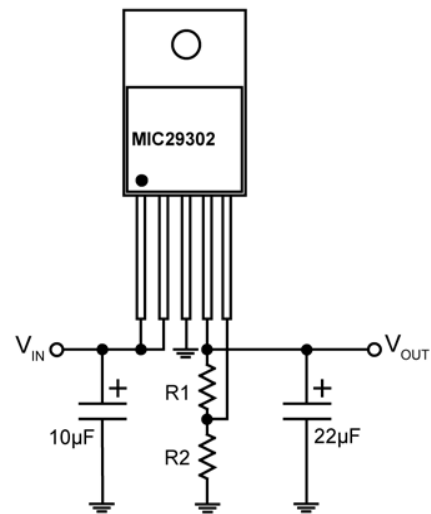

Figure 4. Adjustable Regulator with Resistors

Enable Input

MIC29302 features an enable (EN) input that allows ON/OFF control of the device. Special design allows "zero" current drain when the device is disabled—only microamperes of leakage current flows. The EN input has TTL/CMOS compatible thresholds for simple interfacing with logic, or may be directly tied to V_{IN} . Enabling the regulator requires approximately 20µA of current into the EN pin.

3A Fast-Response LDO Regulator

PACKAGE

T0263-5

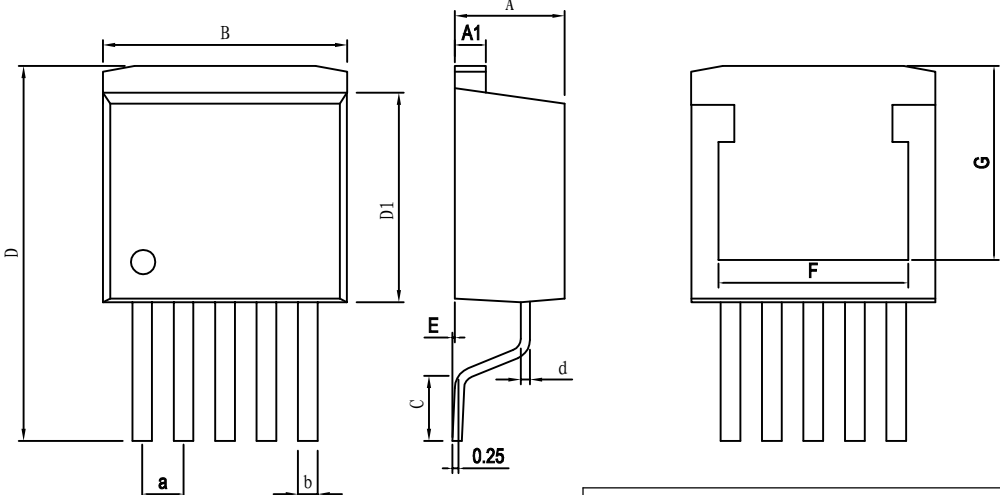

Symbol :	Min :	Max :	Symbol :	Min :	Max :
A	4.400	4.600	E	0	0.305
A1	1.250	1.300	F	7.80 TYP	
B	9.800	10.41	G	7.97 TYP	
C	2.100	2.600	a	1.680	1.720
D	14.440	15.340	b	0.710	0.910
D1	8.450	8.950			

T0220-5

Top View

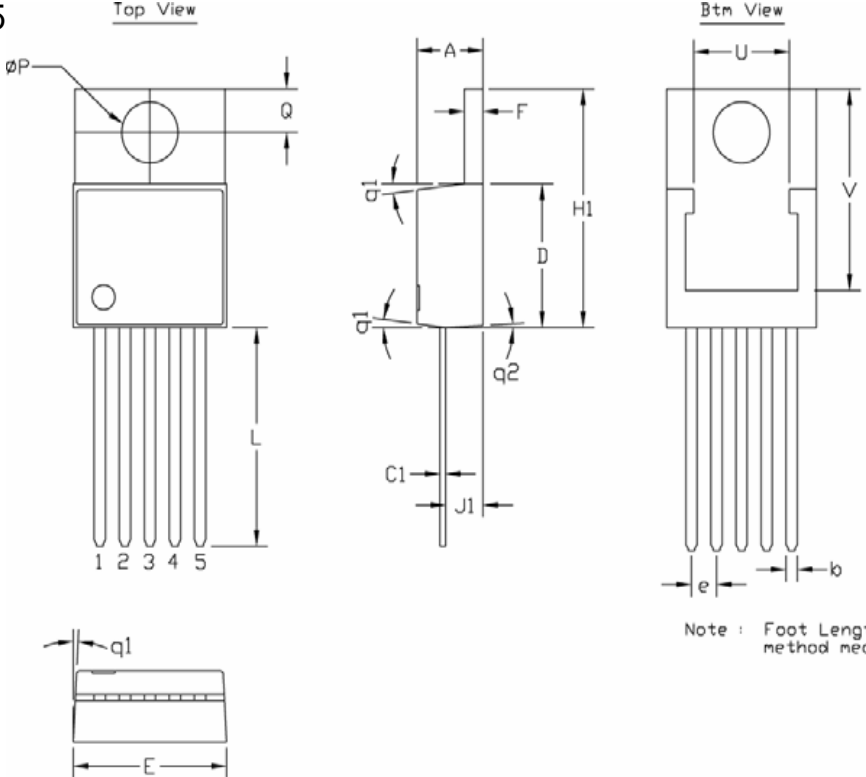

PDS	INCH	
	MIN	MAX
A	0.160	0.190
b	0.025	0.040
C1	0.012	0.022
d	0.351	0.361
E	0.385	0.420
e	0.062	0.072
F	0.045	0.055
H1	0.560	0.595
J1	0.080	0.120
øP	0.146	0.156
Q	0.103	0.113
L	0.500	0.580
q1	3°	10°
q2	1°	7°
U	0.256	Ref.
V	0.486	Ref.

Note : Foot Length using gauge plane method measurement 0.010".

ORDERING INFORMATION

Order code	Package	Baseqty	Deliverymode
UMW MIC29302WT	TO-220	1000	BOX
UMW MIC29302WU	TO-263	750	Tape and reel

单击下面可查看定价，库存，交付和生命周期等信息

[>>UMW\(友台半导体\)](#)