

Description

The SOT-223 package is designed for surface-mounting using vapor phase, infrared, or wave soldering techniques. Its unique package design allows for easy automatic pick-and-place as with other SOT or SOP packages but has the added advantage of improved thermal performance due to an enlarged tab for heatsinking. Power dissipation of greater than 1.25 W is possible in a typical surface mount application.

Features

- $V_{DS} (V) = -60V$
- $I_D = -8A (V_{GS} = -10V)$
- $R_{DS(ON)} < 62m\Omega (V_{GS} = -10V)$

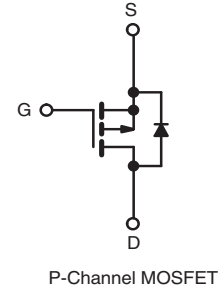
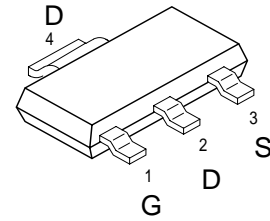

ABSOLUTE MAXIMUM RATINGS ($T_C = 25\text{ }^\circ\text{C}$, unless otherwise noted)

PARAMETER		SYMBOL	LIMIT	UNIT
Drain-Source Voltage		V_{DS}	-60	V
Gate-Source Voltage		V_{GS}	± 20	
Continuous Drain Current	V_{GS} at -10 V $T_C = 25\text{ }^\circ\text{C}$	I_D	-8	A
Pulsed Drain Current ^a		I_{DM}	-14	
Linear Derating Factor			0.025	W/ $^\circ\text{C}$
Linear Derating Factor (PCB Mount) ^e			0.017	
Single Pulse Avalanche Energy ^b		E_{AS}	140	mJ
Repetitive Avalanche Current ^a		I_{AR}	-1.8	A
Repetitive Avalanche Energy ^a		E_{AR}	0.31	mJ
Maximum Power Dissipation	$T_C = 25\text{ }^\circ\text{C}$	P_D	3.1	W
Maximum Power Dissipation (PCB Mount) ^e	$T_A = 25\text{ }^\circ\text{C}$		2.0	
Peak Diode Recovery dV/dt ^c		dV/dt	-4.5	V/ns
Operating Junction and Storage Temperature Range		T_J, T_{stg}	-55 to +150	$^\circ\text{C}$
Soldering Recommendations (Peak Temperature) ^d	for 10 s		300	

Notes

- a. Repetitive rating; pulse width limited by maximum junction temperature (see fig. 11).
- b. $V_{DD} = -25\text{ V}$, starting $T_J = 25\text{ }^\circ\text{C}$, $L = 50\text{ mH}$, $R_g = 25\text{ }\Omega$, $I_{AS} = -1.8\text{ A}$ (see fig. 12).
- c. $I_{SD} \leq -6.7\text{ A}$, $dI/dt \leq 90\text{ A}/\mu\text{s}$, $V_{DD} \leq V_{DS}$, $T_J \leq 150\text{ }^\circ\text{C}$.
- d. 1.6 mm from case.

THERMAL RESISTANCE RATINGS				
PARAMETER	SYMBOL	TYP.	MAX.	UNIT
Maximum Junction-to-Ambient (PCB Mount) ^a	R _{thJA}		60	°C/W
Maximum Junction-to-Case (Drain)	R _{thJC}		40	

Note

a. When mounted on 1" square PCB (FR-4 or G-10 material).

SPECIFICATIONS (T _J = 25 °C, unless otherwise noted)							
PARAMETER	SYMBOL	TEST CONDITIONS		MIN.	TYP.	MAX.	UNIT
Static							
Drain-Source Breakdown Voltage	V _{DS}	V _{GS} = 0 V, I _D = 250 μA		-60			V
V _{DS} Temperature Coefficient	ΔV _{DS} /T _J	Reference to 25 °C, I _D = 1 mA			-0.059		V/°C
Gate-Source Threshold Voltage	V _{GS(th)}	V _{DS} = V _{GS} , I _D = 250 μA		-2.0		-4.0	V
Gate-Source Leakage	I _{GSS}	V _{GS} = ± 20 V				± 100	nA
Zero Gate Voltage Drain Current	I _{DSS}	V _{DS} = -60 V, V _{GS} = 0 V				- 100	μA
		V _{DS} = -48 V, V _{GS} = 0 V, T _J = 125 °C				-500	
Drain-Source On-State Resistance	R _{DS(on)}	V _{GS} = -10 V	I _D = -8 A ^b			62	mΩ
Forward Transconductance	g _{fs}	V _{DS} = - 25 V, I _D = -8 A ^b		1.3			S
Dynamic							
Input Capacitance	C _{iss}	V _{GS} = 0 V, V _{DS} = 25 V, f = 1.0 MHz, see fig. 5			270		pF
Output Capacitance	C _{oss}				170		
Reverse Transfer Capacitance	C _{rss}				31		
Total Gate Charge	Q _g	V _{GS} = - 10 V	I _D = - 6.7 A, V _{DS} = - 48 V, see fig. 6 and 13 ^b			12	nC
Gate-Source Charge	Q _{gs}					3.8	
Gate-Drain Charge	Q _{gd}					5.1	
Turn-On Delay Time	t _{d(on)}	V _{DD} = - 30 V, I _D = - 6.7 A, R _g = 24 Ω, R _D = 4.0 Ω, see fig. 10 ^b			11		ns
Rise Time	t _r				63		
Turn-Off Delay Time	t _{d(off)}				9.6		
Fall Time	t _f				31		
Internal Drain Inductance	L _D	Between lead, 6 mm (0.25") from package and center of die contact			4.0		nH
Internal Source Inductance	L _S				6.0		
Drain-Source Body Diode Characteristics							
Continuous Source-Drain Diode Current	I _S	MOSFET symbol showing the integral reverse p - n junction diode				- 1.8	A
Pulsed Diode Forward Current ^a	I _{SM}					- 14	
Body Diode Voltage	V _{SD}	T _J = 25 °C, I _S = - 1.8 A, V _{GS} = 0 V ^b				- 5.5	V
Body Diode Reverse Recovery Time	t _{rr}	T _J = 25 °C, I _F = - 6.7 A, di/dt = 100 A/μs ^b			80	160	ns
Body Diode Reverse Recovery Charge	Q _{rr}				0.096	0.19	μC
Forward Turn-On Time	t _{on}	Intrinsic turn-on time is negligible (turn-on is dominated by L _S and L _D)					

Notes

a. Repetitive rating; pulse width limited by maximum junction temperature

b. Pulse width ≤ 300 μs; duty cycle ≤ 2 %.

TYPICAL CHARACTERISTICS

(25 °C, unless otherwise noted)

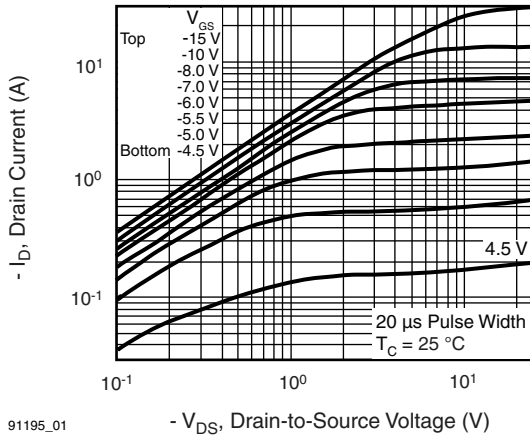

91195_01 **Fig. 1 - Typical Output Characteristics, $T_C = 25\text{ °C}$**

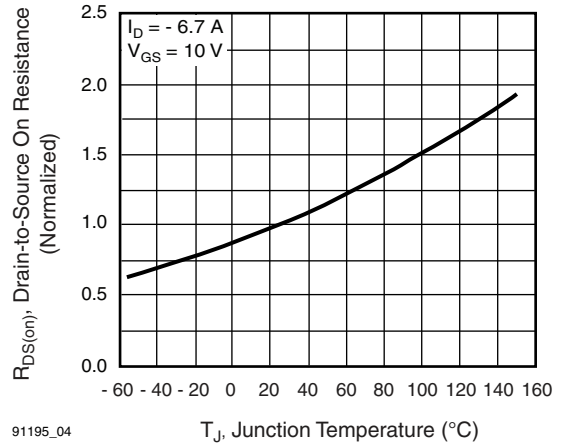

91195_04 **Fig. 4 - Normalized On-Resistance vs. Temperature**

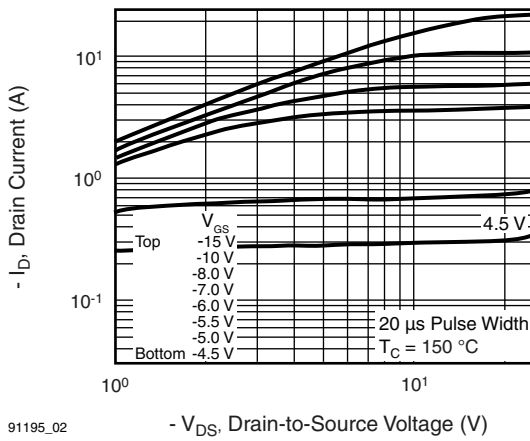

91195_02 **Fig. 2 - Typical Output Characteristics, $T_C = 150\text{ °C}$**

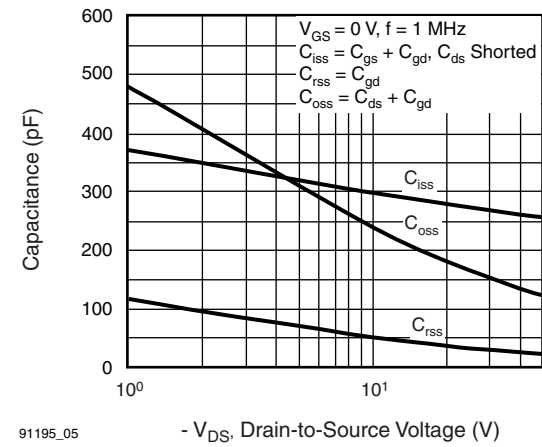

91195_05 **Fig. 5 - Typical Capacitance vs. Drain-to-Source Voltage**

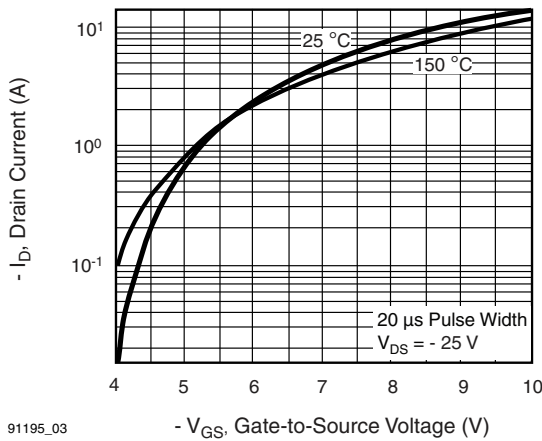

91195_03 **Fig. 3 - Typical Transfer Characteristics**

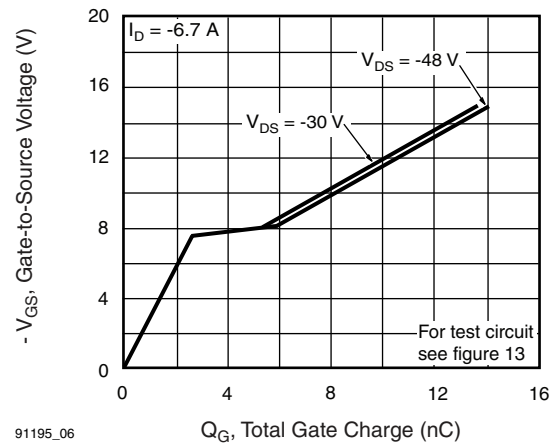

91195_06 **Fig. 6 - Typical Gate Charge vs. Gate-to-Source Voltage**

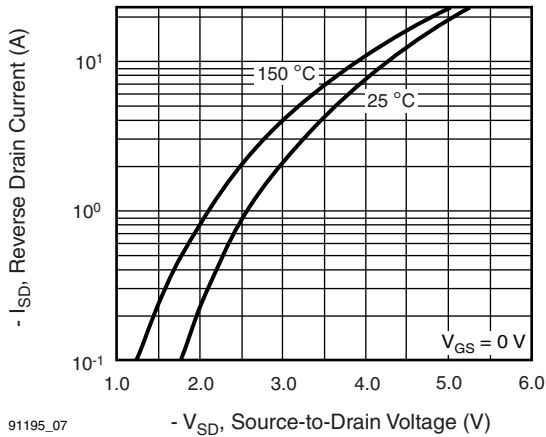

91195_07

Fig. 7 - Typical Source-Drain Diode Forward Voltage

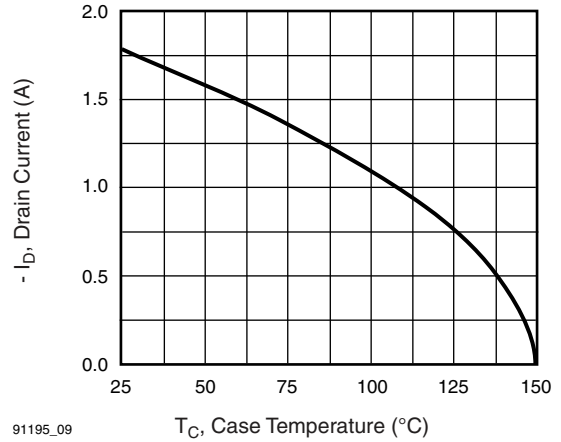

91195_09

Fig. 9 - Maximum Drain Current vs. Case Temperature

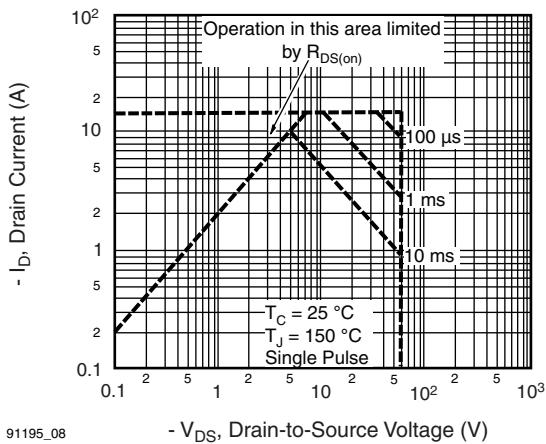

91195_08

Fig. 8 - Maximum Safe Operating Area

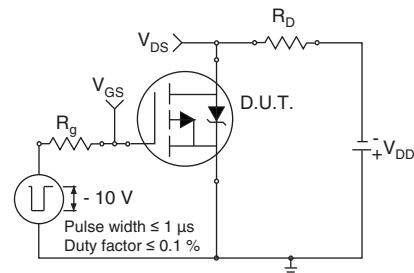

Fig. 10a - Switching Time Test Circuit

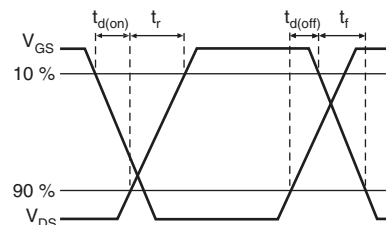
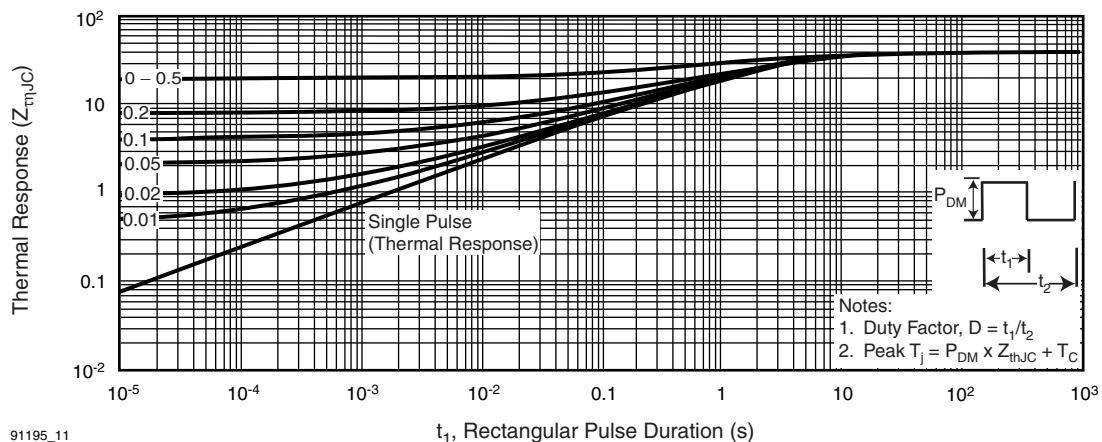

Fig. 10b - Switching Time Waveforms



91195_11

Fig. 11 - Maximum Effective Transient Thermal Impedance, Junction-to-Case

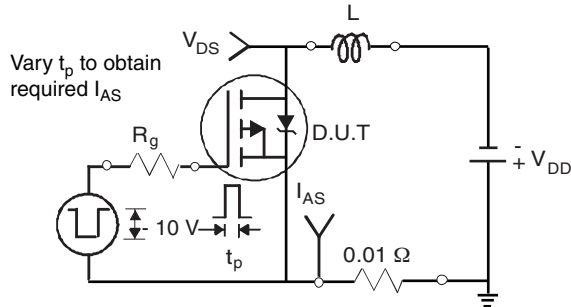

Fig. 12a - Unclamped Inductive Test Circuit

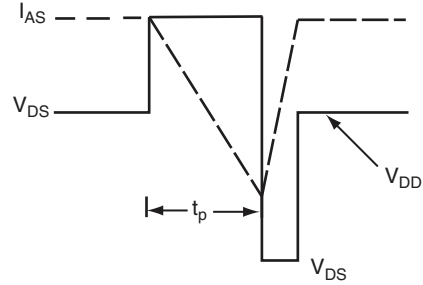

Fig. 12b - Unclamped Inductive Waveforms

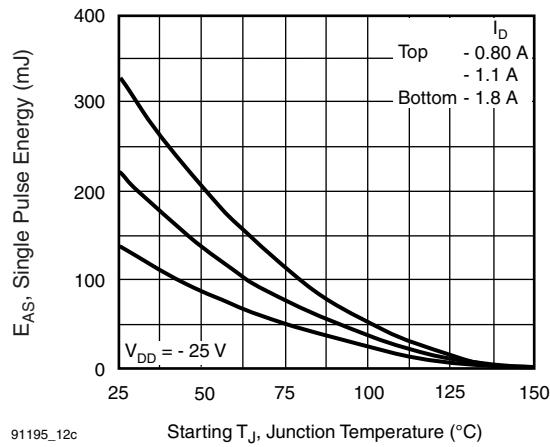

Fig. 12c - Maximum Avalanche Energy vs. Drain Current

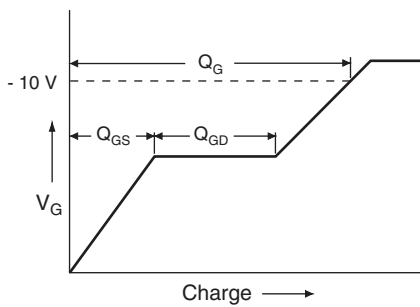

Fig. 13a - Basic Gate Charge Waveform

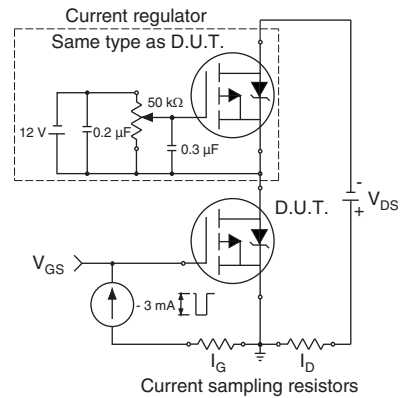
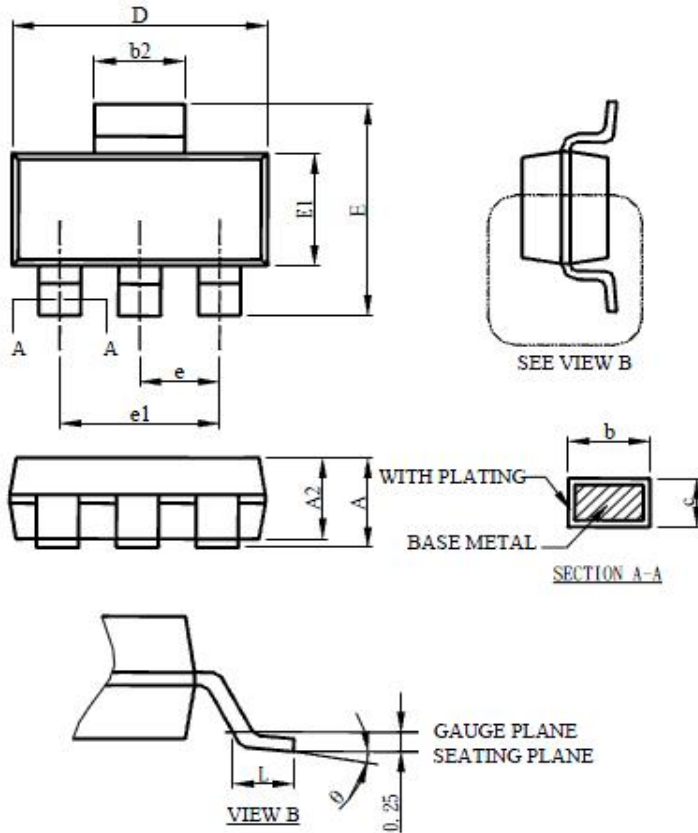

Fig. 13b - Gate Charge Test Circuit

Package Mechanical Data SOT-223



SYMBOL	SOT-223	
	MILLIMETERS	
	MIN.	MAX.
A		1.80
A1	0.02	0.10
A2	1.55	1.65
b	0.66	0.84
b2	2.90	3.10
c	0.23	0.33
D	6.30	6.70
E	6.70	7.30
E1	3.30	3.70
e	2.30 BSC	
e1	4.60 BSC	
L	0.90	
θ	0°	8°

Note:

1. Refer to JEDEC TO-261AA.
2. Dimension D and E1 are determined at the outermost extremes of the plastic body exclusive of mold flash, tie bar burrs, gate burrs, and interlead flash, but including any mismatch between the top and bottom of the plastic body.
3. Controlling dimension is millimeter, converted inch dimensions are not necessarily exact.

Marking

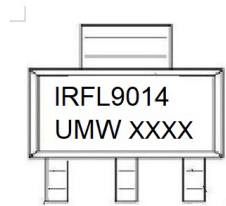

Ordering information

Order code	Package	Baseqty	Deliverymode
UMW IRFL9014TR	SOT-223	2500	Tape and reel

单击下面可查看定价，库存，交付和生命周期等信息

[>>UMW\(友台半导体\)](#)