

## DESCRIPTION

The SDxxC Series is designed for applications requiring transient overvoltage protection capability. They are intended for use in voltage and ESD sensitive equipment such as computers, printers, business machines, communication systems, medical equipment and other applications. These devices are ideal for situations where board space is at a premium.

This series has been specifically designed to protect sensitive components which are connected to power, data and transmission lines from overvoltage caused by ESD (electrostatic discharge), CDE (Cable Discharge Events), and EFT (electrical fast transients).

## APPLICATIONS

- Cell Phone Handsets and Accessories
- Microprocessor based equipment
- Personal Digital Assistants (PDA's)
- Notebooks, Desktops, and Servers
- Portable Instrumentation
- Networking and Telecom
- Serial and Parallel Ports.
- Peripherals

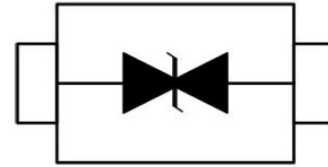

## FEATURES

- IEC61000-4-2 (ESD) ±15kV (air), ±8kV (contact)
- IEC61000-4-4 (EFT) 40A (5/50ns)
- 350 Watts Peak Pulse Power per (tp=8/20µs)
- Protects one I/O line (bidirectional)
- Low clamping voltage
- Working voltages :  
3V,5V,8V,12V,15V,18V,20V,24V,36V
- Low leakage current

## MACHANICAL DATA

- SOD-323 package
- Flammability Rating: UL 94V-0
- Packaging: Tape and Reel
- High temperature soldering guaranteed:260°C/10s
- Reel size: 7 inch
- MSL 1

### ABSOLUTE MAXIMUM RATING

Symbol	Parameter	Value	Units
$V_{ESD}$	ESD per IEC 61000-4-2 (Air)	±30	kV
	ESD per IEC 61000-4-2 (Contact)	±30	
$P_{PP}$	Peak Pulse Power (8/20 $\mu$ s)	350	W
$T_{OPT}$	Operating Temperature	-55/+150	°C
$T_{STG}$	Storage Temperature	-55/+150	°C
$T_L$	Lead Soldering Temperature	260 (10 sec.)	°C

### ELECTRICAL CHARACTERISTICS ( $T_{amb}=25$ )

PART NUMBER	DEVICE MARKING	$V_{RWM}$ (V) (max.)	$V_B$ (V) (min.)	$I_T$ (mA)	$V_C@1A$ (V) (max.)	$V_C$ (V) (max.) (@A)		$I_R$ ( $\mu$ A) (max.)	$C_T$ (pF) (max.)
UMW SD03C	2A	3.3	4.0	1	7.5	16.0	20	40	450
UMW SD05C	2B	5.0	6.0	1	9.8	18.0	17	10	200
UMW SD08C	2C	8.0	8.5	1	13.4	24.0	15	2	120
UMW SD12C	2D	12.0	13.3	1	19.0	32.0	11	1	75
UMW SD15C	2J	15.0	16.7	1	24.0	38.0	10	1	68
UMW SD18C	2K	18.0	20.0	1	29.0	45.0	9	1	57
UMW SD20C	2L	20.0	22.3	1	35.0	50.0	8	1	52
UMW SD24C	2H	24.0	26.7	1	43.0	52.0	7	1	50
UMW SD36C	2N	36.0	40.0	1	60.0	75.0	4.5	1	35

**ELECTRICAL CHARACTERISTICS CURVE**

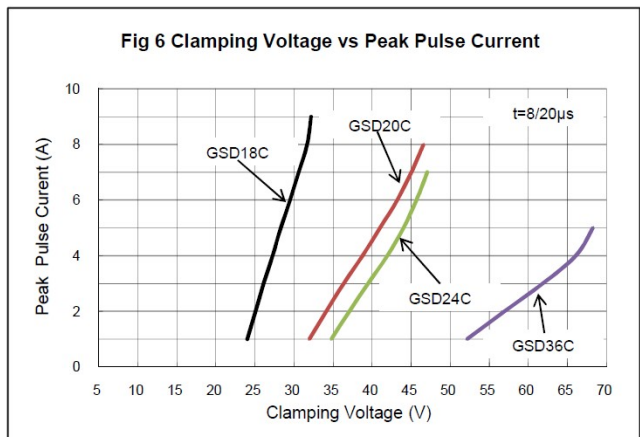
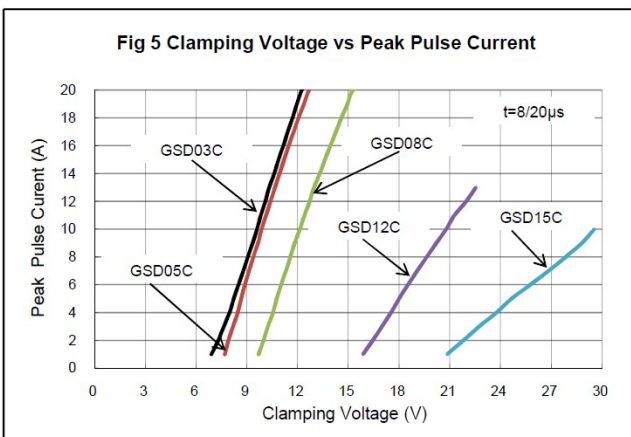
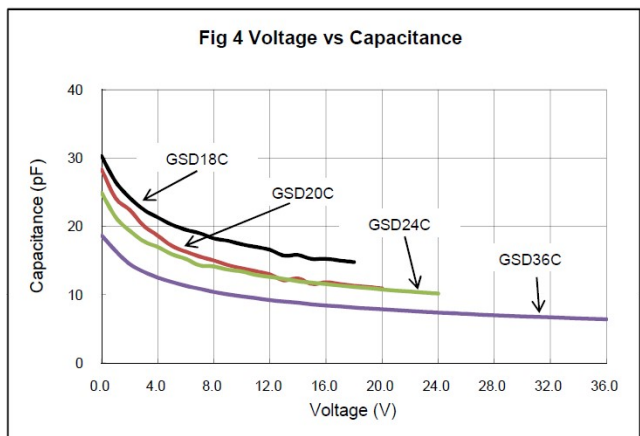
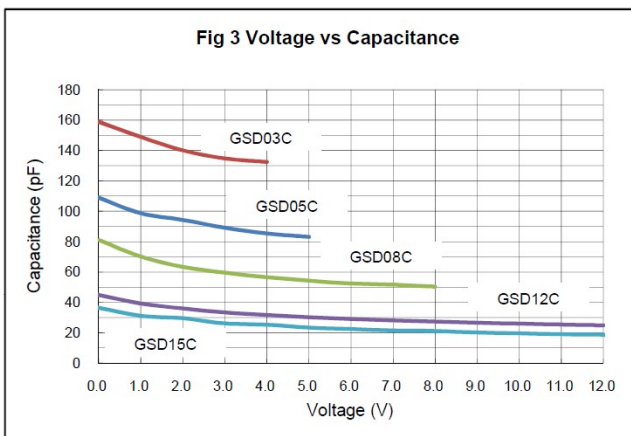
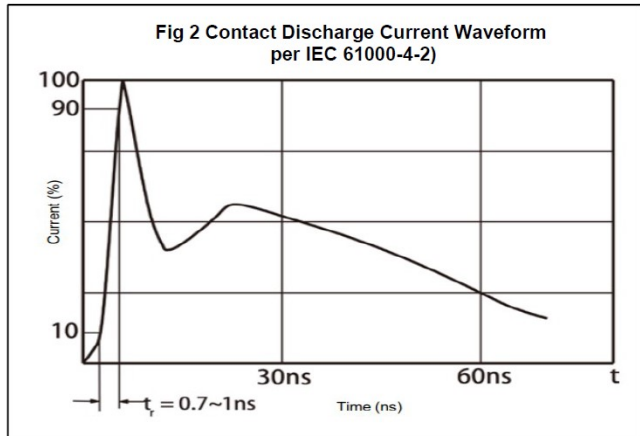
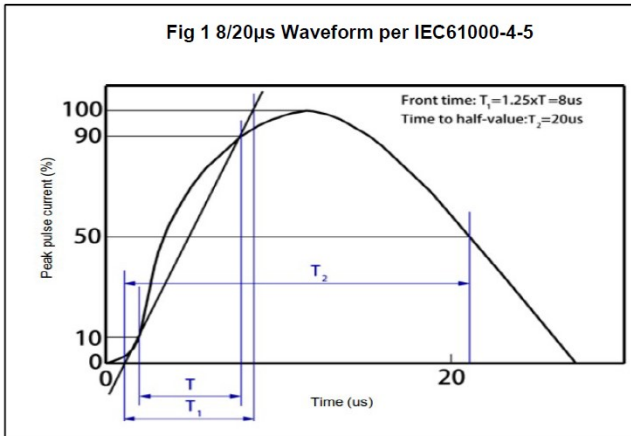

SOD-323 PACKAGE OUTLINE DIMENSIONS

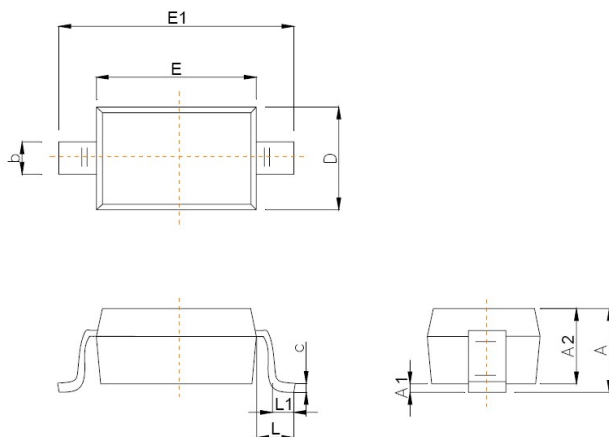

Symbol	Dimensions In Millimeters	
	Min	Max
A		1.00
A1	0.000	0.100
A2	0.800	0.900
b	0.250	0.350
c	0.080	0.150
D	1.200	1.400
E	1.600	1.800
E1	2.500	2.700
e	1.800	2.040
L	0.475 REF	
L1	0.250	0.400
θ	0°	8°

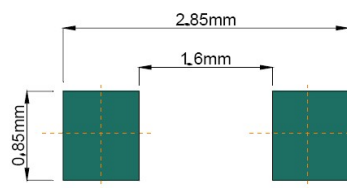

Recommended Pad outline

Ordering information

Order code	Package	Base qty	Delivery mode
UMW SDxxC	SOD-323	3000	Tape and reel

单击下面可查看定价，库存，交付和生命周期等信息

[>>UMW\(友台半导体\)](#)