

Description

The IRFR0924NTR uses advanced trench technology to provide excellent $R_{DS(ON)}$, low gate charge and operation with gate voltages as low as 4.5V. This device is suitable for use as a Battery protection or in other Switching application.

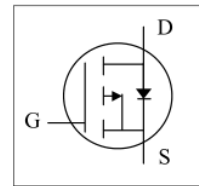

General Features

$V_{DS} = -60V$ $I_D = -20 A$

$R_{DS(ON)} < 75m\Omega @ V_{GS}=10V$

Application

Battery protection

Load switch

Uninterruptible power supply

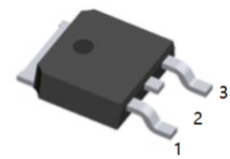

1.G 2.D 3.S
TO-252(DPAK) top view

Absolute Maximum Ratings ($T_A=25^\circ C$ unless otherwise noted)

Symbol	Parameter	Rating	Units
V_{DS}	Drain-Source Voltage	-60	V
V_{GS}	Gate-Source Voltage	± 20	V
$I_D@T_C=25^\circ C$	Continuous Drain Current, $V_{GS} @ -10V^1$	-20	A
$I_D@T_C=100^\circ C$	Continuous Drain Current, $V_{GS} @ -10V^1$	-12	A
$I_D@T_A=25^\circ C$	Continuous Drain Current, $V_{GS} @ -10V^1$	-4.3	A
$I_D@T_A=70^\circ C$	Continuous Drain Current, $V_{GS} @ -10V^1$	-3.5	A
I_{DM}	Pulsed Drain Current ²	-36	A
EAS	Single Pulse Avalanche Energy ³	35.4	mJ
I_{AS}	Avalanche Current	-26.6	A
$P_D@T_C=25^\circ C$	Total Power Dissipation ⁴	34.7	W
$P_D@T_A=25^\circ C$	Total Power Dissipation ⁴	2	W
T_{STG}	Storage Temperature Range	-55 to 150	$^\circ C$
T_J	Operating Junction Temperature Range	-55 to 150	$^\circ C$
$R_{\theta JA}$	Thermal Resistance Junction-Ambient ¹	62	$^\circ C/W$
$R_{\theta JC}$	Thermal Resistance Junction-Case ¹	3.6	$^\circ C/W$

Electrical Characteristics (T_A=25°C unless otherwise noted)

Symbol	Parameter	Conditions	Min.	Typ.	Max.	Unit
BV _{DSS}	Drain-Source Breakdown Voltage	V _{GS} =0V, I _D =-250uA	-60	---	---	V
ΔBV _{DSS} / ΔT _J	BV _{DSS} Temperature Coefficient	Reference to 25°C, I _D =-1mA	---	-0.03	---	V/°C
R _{DS(on)}	Static Drain-Source On-Resistance	V _{GS} =-10V, I _D =-12A	---	53	75	mΩ
		V _{GS} =-4.5V, I _D =-8A	---	64	105	
V _{GS(th)}	Gate Threshold Voltage	V _{GS} =V _{DS} , I _D =-250uA	-1.2	1.5	-2.5	V
ΔV _{GS(th)}	V _{GS(th)} Temperature Coefficient		---	4.56	---	mV/°C
I _{DSS}	Drain-Source Leakage Current	V _{DS} =-48V, V _{GS} =0V, T _J =25°C	---	---	1	uA
		V _{DS} =-48V, V _{GS} =0V, T _J =55°C	---	---	5	
I _{GSS}	Gate-Source Leakage Current	V _{GS} =±20V, V _{DS} =0V	---	---	±100	nA
g _{fs}	Forward Transconductance	V _{DS} =-5V, I _D =-12A	---	15.4	---	S
R _g	Gate Resistance	V _{DS} =0V, V _{GS} =0V, f=1MHz	---	13.5	---	Ω
Q _g	Total Gate Charge (-4.5V)	V _{DS} =-48V, V _{GS} =-4.5V, I _D =-10A	---	9.86	---	nC
Q _{gs}	Gate-Source Charge		---	3.08	---	
Q _{gd}	Gate-Drain Charge		---	2.95	---	
T _{d(on)}	Turn-On Delay Time	V _{DD} =-15V, V _{GS} =-10V, R _G =3.3Ω, I _D =-1A	---	28.8	---	ns
T _r	Rise Time		---	19.8	---	
T _{d(off)}	Turn-Off Delay Time		---	60.8	---	
T _f	Fall Time		---	7.2	---	
C _{iss}	Input Capacitance	V _{DS} =-15V, V _{GS} =0V, f=1MHz	---	1447	---	pF
C _{oss}	Output Capacitance		---	97.3	---	
C _{rss}	Reverse Transfer Capacitance		---	70	---	
I _S	Continuous Source Current ^{1,5}	V _G =V _D =0V, Force Current	---	---	-18	A
I _{SM}	Pulsed Source Current ^{2,5}		---	---	-36	A
V _{SD}	Diode Forward Voltage ²	V _{GS} =0V, I _S =-1A, T _J =25°C	---	---	-1.2	V

Note :

- 1.The data tested by surface mounted on a 1 inch² FR-4 board with 2OZ copper.
- 2.The data tested by pulsed, pulse width ≤ 300us, duty cycle ≤ 2%
- 3.The EAS data shows Max. rating. The test condition is V_{DD}=-25V, V_{GS}=-10V, L=0.1mH, I_{AS}=-26.6A
- 4.The power dissipation is limited by 150°C junction temperature
- 5.The data is theoretically the same as I_D and I_{DM}, in real applications, should be limited by total power dissipation.

Typical Characteristics

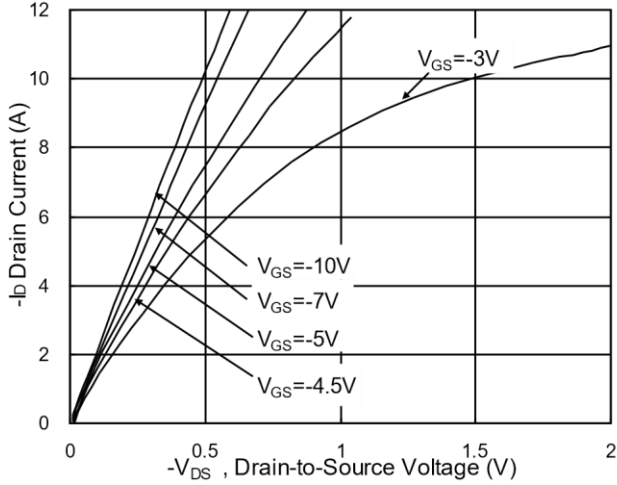

Fig.1 Typical Output Characteristics

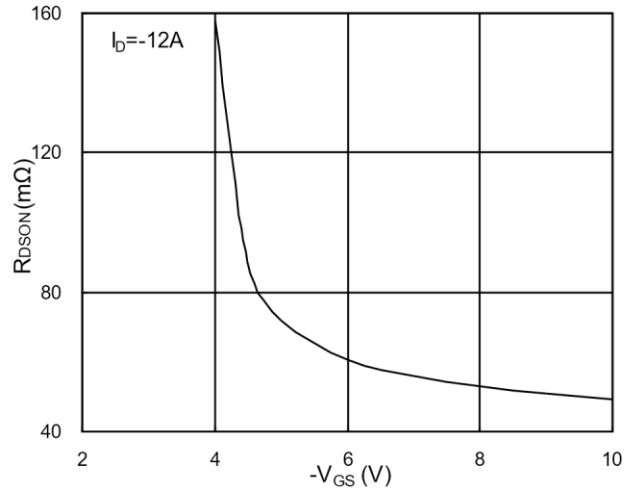

Fig.2 On-Resistance v.s Gate-Source

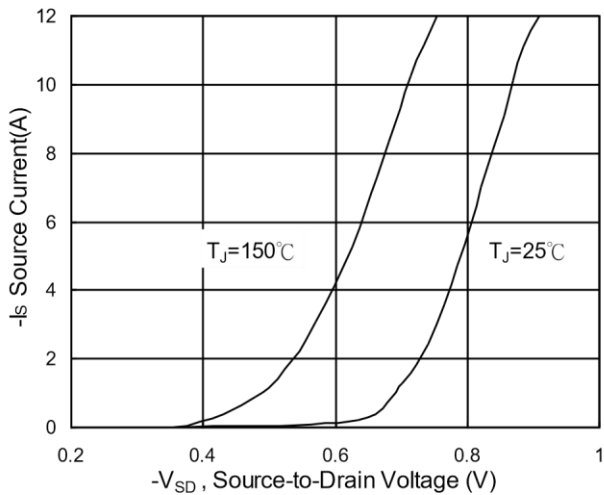

Fig.3 Forward Characteristics of Reverse

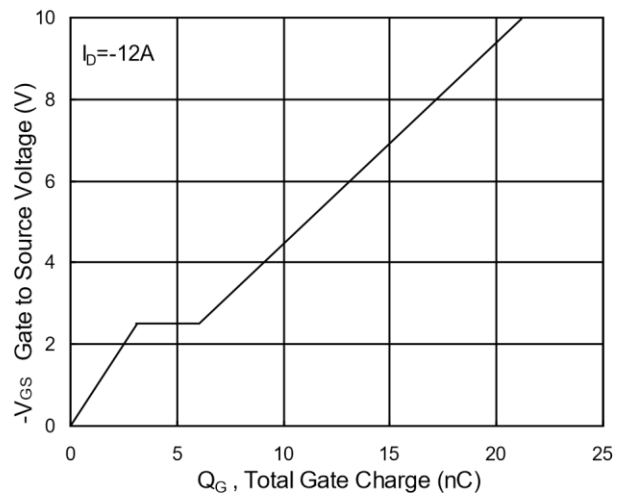

Fig.4 Gate-Charge Characteristics

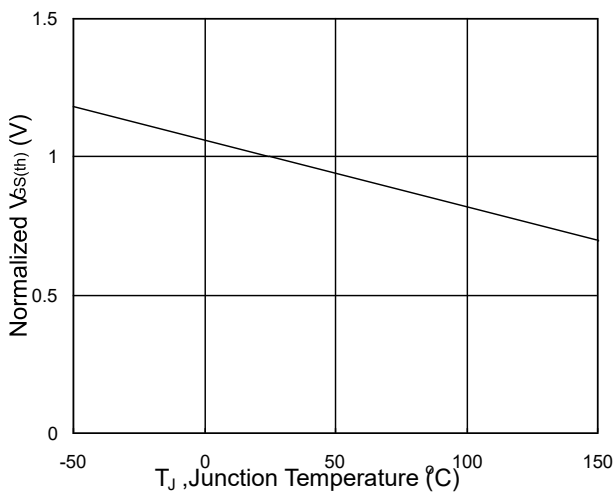

Fig.5 Normalized $V_{GS(th)}$ v.s T_J

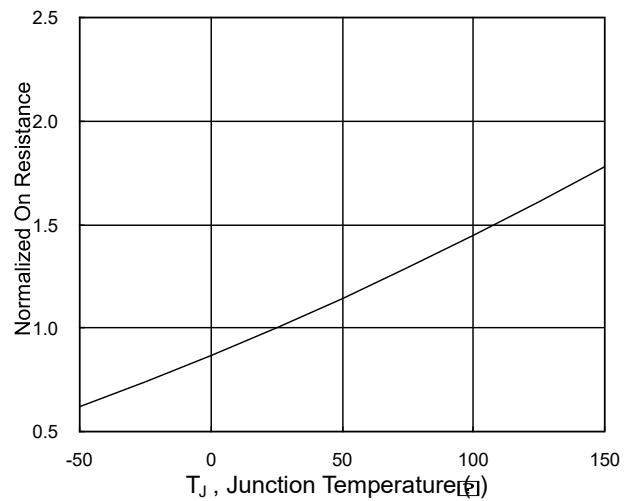

Fig.6 Normalized $R_{DS(on)}$ v.s T_J

-60V P-Channel Enhancement Mode MOSFET

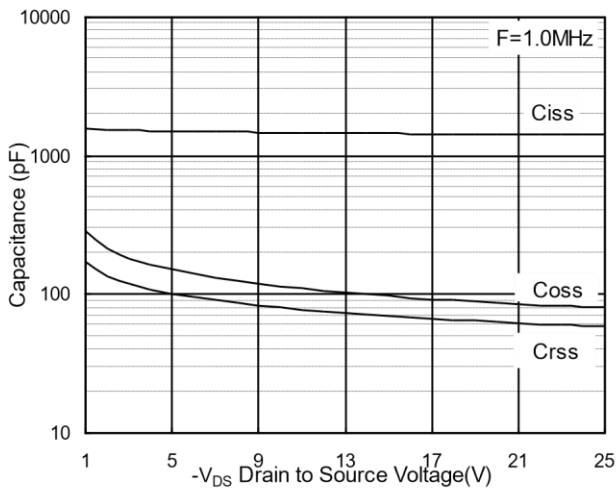

Fig.7 Capacitance

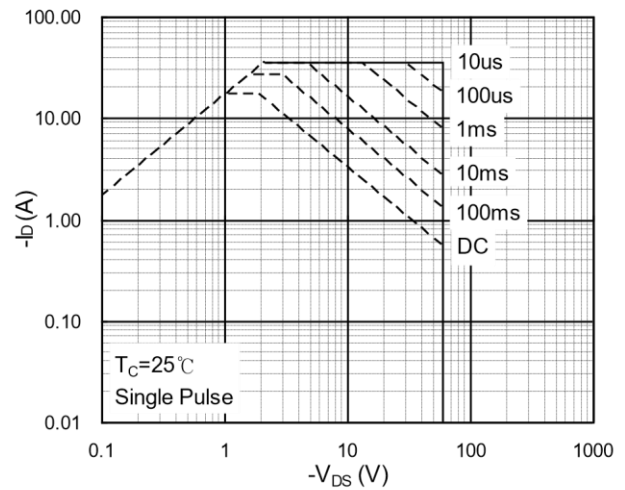

Fig.8 Safe Operating Area

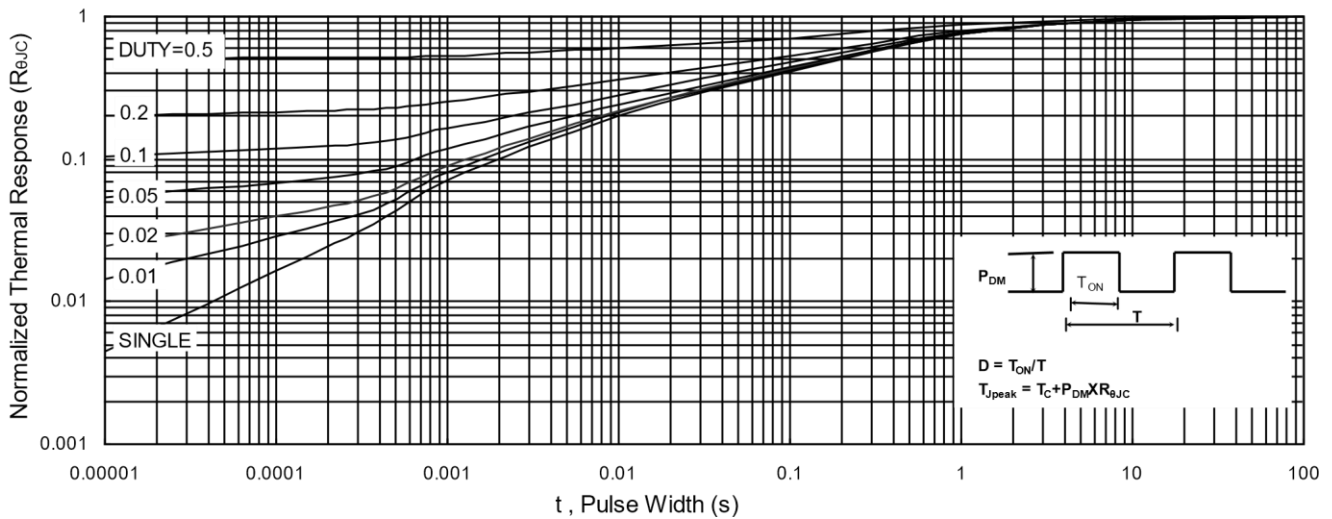

Fig.9 Normalized Maximum Transient Thermal Impedance

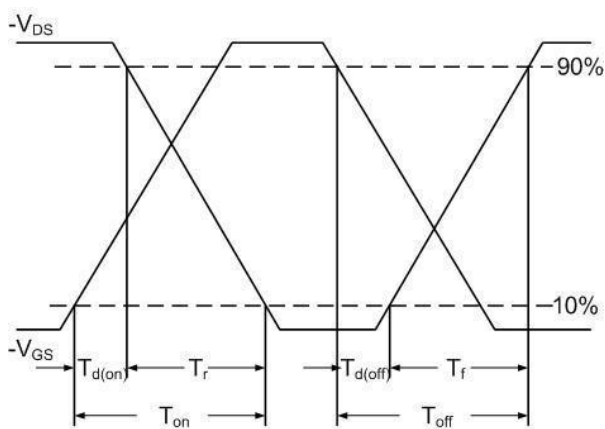

Fig.10 Switching Time Waveform

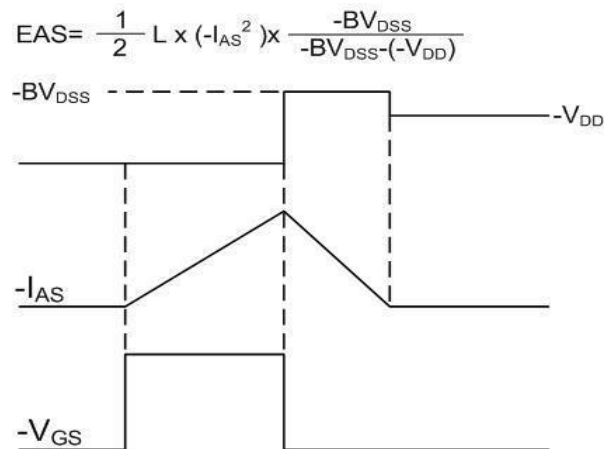
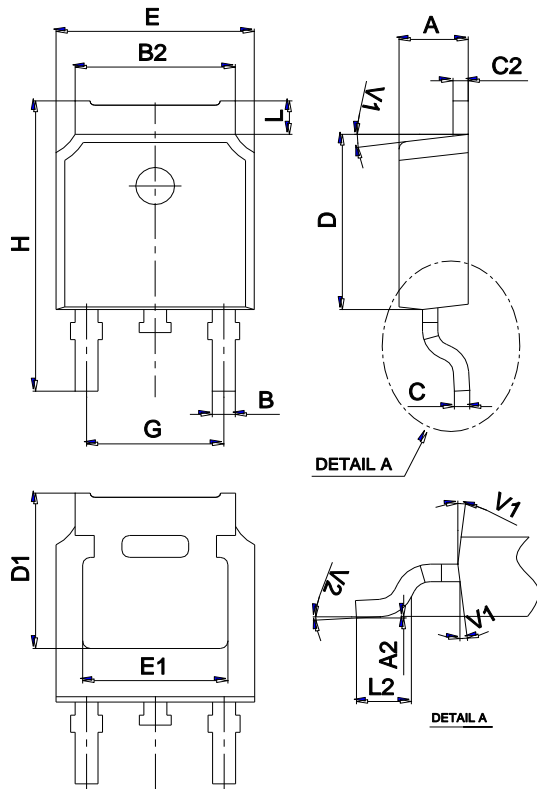

Fig.11 Unclamped Inductive Waveform

$$EAS = \frac{1}{2} L \times (-I_{AS}^2) \times \frac{-BV_{DSS}}{-BV_{DSS} - (-V_{DD})}$$

Package Mechanical Data TO-252



Ref.	Dimensions					
	Millimeters			Inches		
	Min.	Typ.	Max.	Min.	Typ.	Max.
A	2.10		2.50	0.083		0.098
A2	0		0.10	0		0.004
B	0.66		0.86	0.026		0.034
B2	5.18		5.48	0.202		0.216
C	0.40		0.60	0.016		0.024
C2	0.44		0.58	0.017		0.023
D	5.90		6.30	0.232		0.248
D1	5.30REF			0.209REF		
E	6.40		6.80	0.252		0.268
E1	4.63			0.182		
G	4.47		4.67	0.176		0.184
H	9.50		10.70	0.374		0.421
L	1.09		1.21	0.043		0.048
L2	1.35		1.65	0.053		0.065
V1		7°			7°	
V2	0°		6°	0°		6°

Marking

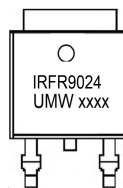

Ordering information

Order code	Package	Baseqty	Deliverymode
UMW IRFR9024NTR	TO-252	2500	Tape and reel

单击下面可查看定价，库存，交付和生命周期等信息

[>>UMW\(友台半导体\)](#)