

**Surface Mount General Purpose Silicon Rectifiers**  
**Reverse Voltage - 50 to 1000 V**  
**Forward Current - 1 A**

### PINNING

PIN	DESCRIPTION
1	Cathode
2	Anode

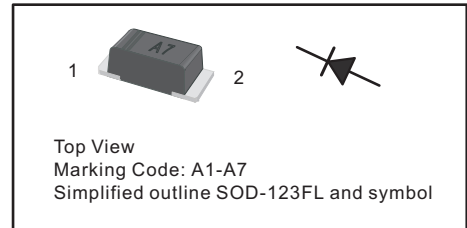

### Maximum Ratings and Electrical characteristics

Ratings at 25 °C ambient temperature unless otherwise specified.

Single phase half-wave 60 Hz, resistive or inductive load, for capacitive load current derate by 20 %.

Parameter	Symbols	1N4001	1N4002	1N4003	1N4004	1N4005	1N4006	1N4007	Units
Maximum Repetitive Peak Reverse Voltage	$V_{RRM}$	50	100	200	400	600	800	1000	V
Maximum RMS voltage	$V_{RMS}$	35	70	140	280	420	560	700	V
Maximum DC Blocking Voltage	$V_{DC}$	50	100	200	400	600	800	1000	V
Maximum Average Forward Rectified Current at $T_a = 65\text{ °C}$	$I_{F(AV)}$	1							A
Peak Forward Surge Current 8.3 ms Single Half Sine Wave Superimposed on Rated Load JEDEC Method )	$I_{FSM}$	25							A
Maximum Instantaneous Forward Voltage at 1A	$V_F$	1.1							V
Maximum DC Reverse Current at Rated DC Blocking Voltage $T_a = 25\text{ °C}$ $T_a = 125\text{ °C}$	$I_R$	5 100							$\mu A$
Typical Junction Capacitance <sup>1)</sup>	$C_j$	4							pF
Typical Thermal Resistance <sup>2)</sup>	$R_{\theta JA}$	180							$^{\circ}C/W$
Operating and Storage Temperature Range	$T_j, T_{stg}$	-55 ~ +150							$^{\circ}C$

1) Measured at 1 MHz and applied reverse voltage of 4 V D.C

2) Thermal resistance from junction to ambient at 0.375" (9.5 mm) lead length, P.C.B. mounted

Fig.1 Forward Current Derating Curve

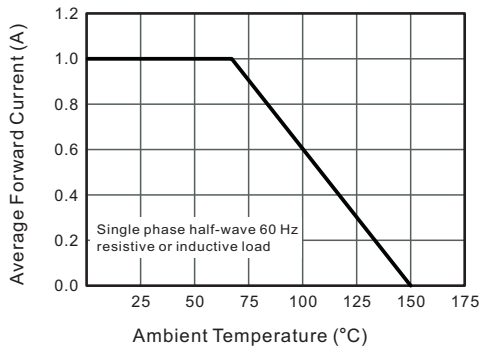

Fig.2 Typical Instantaneous Reverse Characteristics

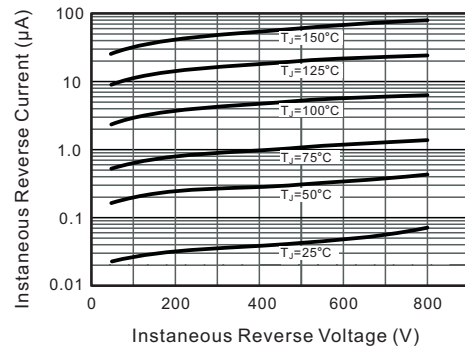

Fig.3 Typical Forward Characteristic

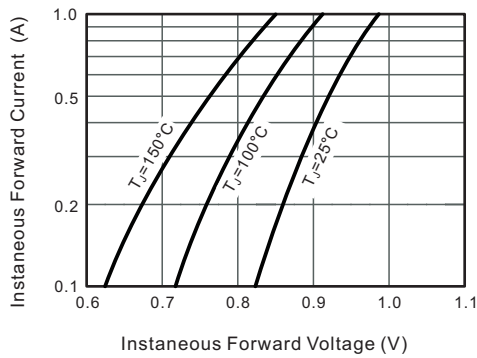
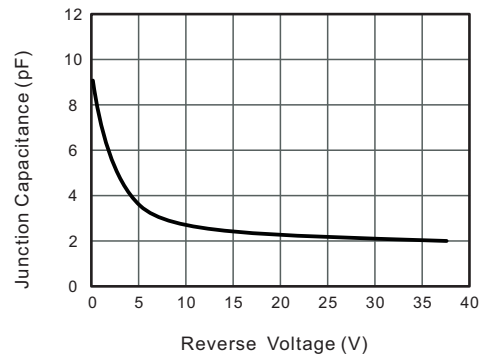
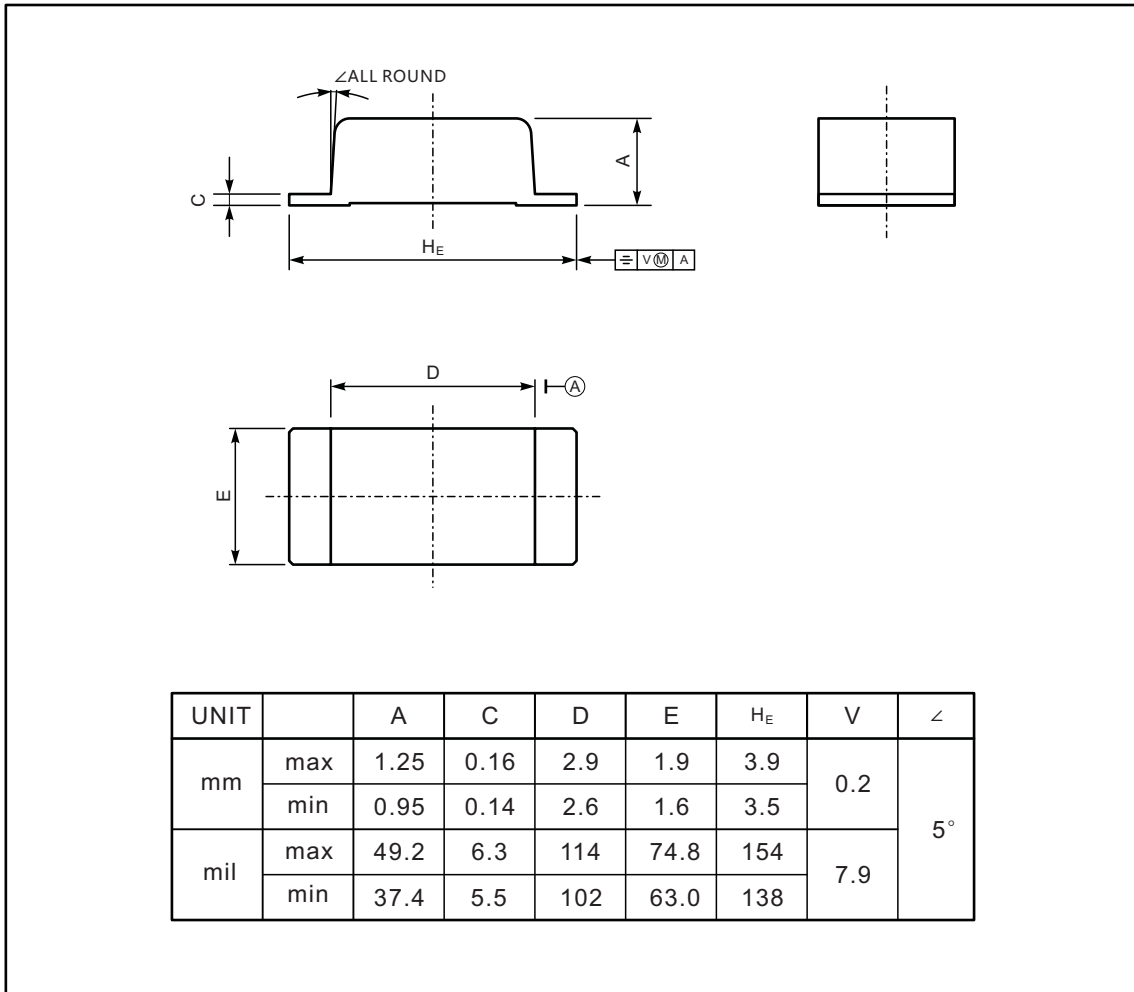

Fig.4 Typical Junction Capacitance



**PACKAGE OUTLINE**

Plastic surface mounted package; 2 leads



**The recommended mounting pad size**

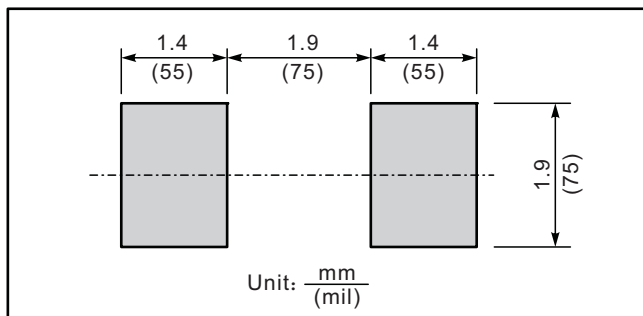

**Marking**

Type number	Marking code
1N4001	A1
1N4002	A2
1N4003	A3
1N4004	A4
1N4005	A5
1N4006	A6
1N4007	A7

• Recommended condition of flow soldering

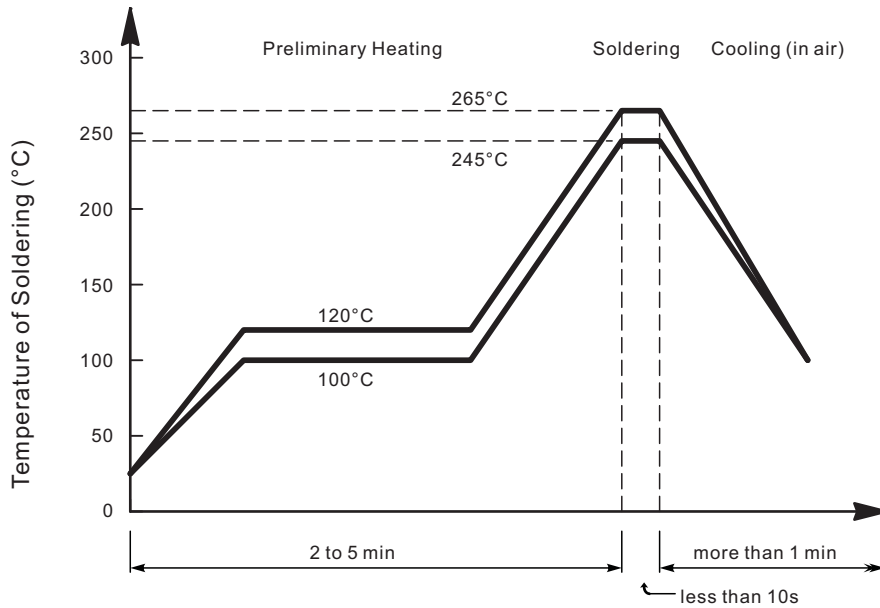

• Recommended condition of reflow soldering

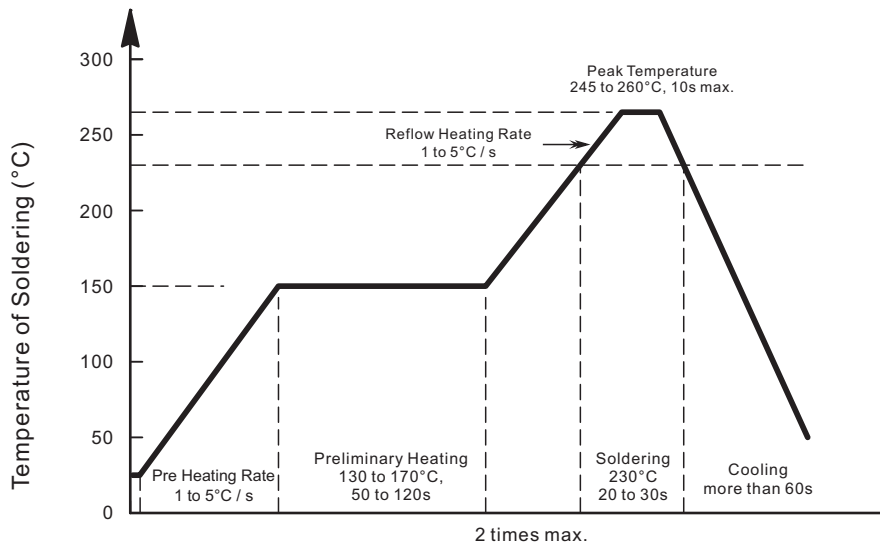

Recommended peak temperature is over 245 °C. If peak temperature is below 245 °C, you may adjust the following parameters; time length of peak temperature (longer), time length of soldering (longer), thickness of solder paste (thicker)

• Condition of hand soldering

Temperature: 370°C  
 Time: 3s max.  
 Times: one time

• Remark:

Lead free solder paste (96.5Sn/3.0Ag/0.5Cu)

单击下面可查看定价，库存，交付和生命周期等信息

[>>UMW\(友台半导体\)](#)