



UNI-ROYAL
厚聲集團

DATA SHEET

Product Name Chip Resistors Array

Part Name 2F01/4F01/2C02/4C02/4C03/2D02/2D03/4D02/4D03/4DP3/16P8 Series

File No. SMD-SP-024

Uniroyal Electronics Global Co., Ltd.

88#, Longteng Road, Economic & Technical Development Zone, Kunshan, Jiangsu, China

Tel +86 512 5763 1411 / 22 /33

Email marketing@uni-royal.cn

Manufacture Plant Uniroyal Electronics Industry Co., Ltd.

Aeon Technology Corporation

Royal Electronic Factory (Thailand) Co., Ltd.

Royal Technology (Thailand) Co., Ltd.

1. Scope

- 1.1 This datasheet is the characteristics of chip resistors array manufactured by UNI-ROYAL.
- 1.2 High density, more than 1 resistors in one small case
- 1.3 Improvement of placement efficiency
- 1.4 Tape/Reel packaging is suitable for automatic placement machine
- 1.5 Superior solderability
- 1.6 Application: Master board, CD&DVD Rom, Hard Disk, RAM

2. Part No. System

Part No. includes 14 codes shown as below:

2.1 1st~4th codes: Part name. E.g.: 2D02,4D02,2D03,4D03,4DP3,16P8,2C02, 4C02, 4C03,2F01,4F01.

2.2 5th~6th codes: Power rating.

E.g.: W=Normal Size		“1~G” = “1~16”		
Wattage	1/10	1/16	1/20	
Normal Size	WA	WG	WM	

If power rating is equal or lower than 1 watt, 5th code would be “W” and 6th code would be a number or letter.

E.g.: WA=1/10W W4=1/4W

2.3 7th code: Tolerance. E.g.: D=±0.5% F=±1% G=±2% J=±5% K= ±10%

2.4 8th~11th codes: Resistance Value.

2.4.1 If value belongs to standard value of E-24 series, the 8th code is zero, 9th~10th codes are the significant figures of resistance value, and the 11th code is the power of ten.

2.4.2 If value belongs to standard value of E-96 series, the 8th~10th codes are the significant figures of resistance value, and the 11th code is the power of ten.

2.4.3 11th codes listed as following:

0=10⁰ 1=10¹ 2=10² 3=10³ 4=10⁴ 5=10⁵ 6=10⁶ J=10⁻¹ K=10⁻² L=10⁻³ M=10⁻⁴

2.5 12th~14th codes.

2.5.1 12th code: Packaging Type. E.g.: T=Tape/Reel

2.5.2 13th code: Standard Packing Quantity.

4=4,000pcs 5=5,000pcs C=10,000pcs E=15,000pcs

2.5.3 14th code: Special features.

E = Environmental Protection, Lead Free, or Standard type.

3. Ordering Procedure

(Example: 4C02 1/16W ±5% 100 Ω T/R-10000)

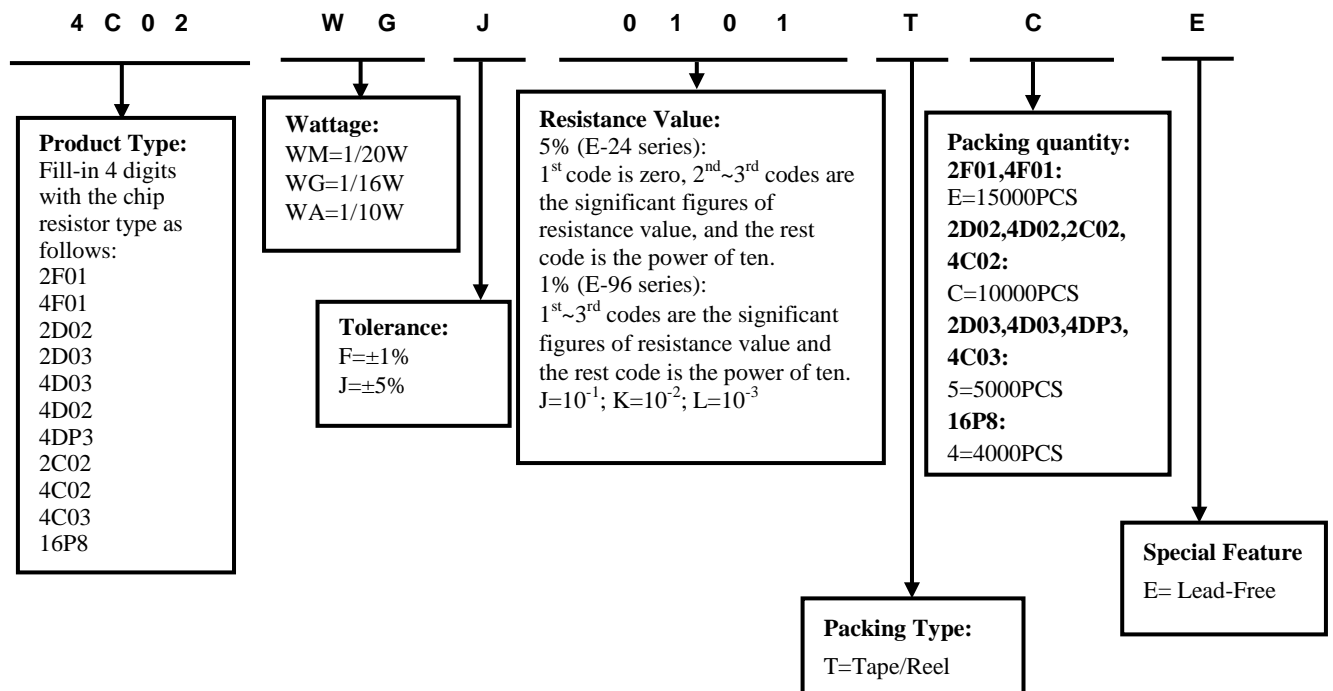

4. Marking

4.1 Normal for 2D02 & 2C02 & 4C02 size, no marking on the body, 0 Ω resistors is no marking too.

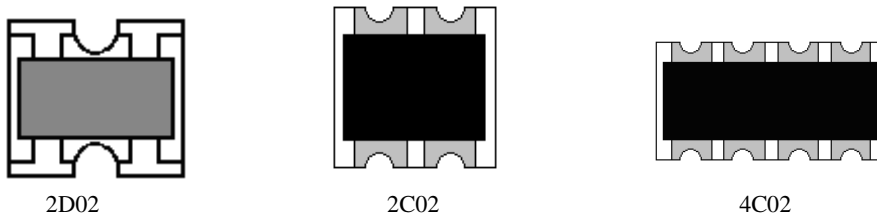

4.2 ±5% Tolerance of 4D02, 2D03, 4D03, 4DP3, 4C03 and 16P8 size: the first two digits are significant figures of resistance and the third denotes number of zeros following .

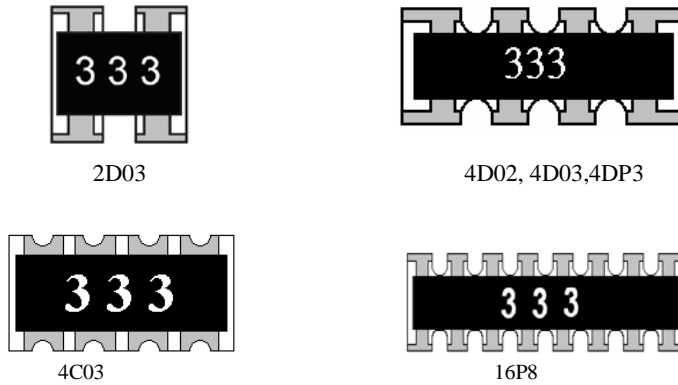

4.3 ±1% Tolerance of 2D03, 4D02, 4D03, 4DP3, 4C03 and 16P8 size: first three digits are significant figures of resistance and the fourth denotes number of zeros following

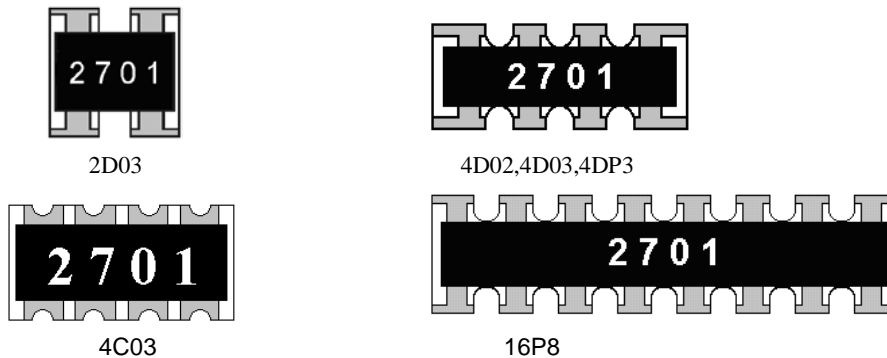

4.4 0 Ω : Normal of 2D03, 4D02, 4D03, 4C03, 16P8 size, the marking as following:

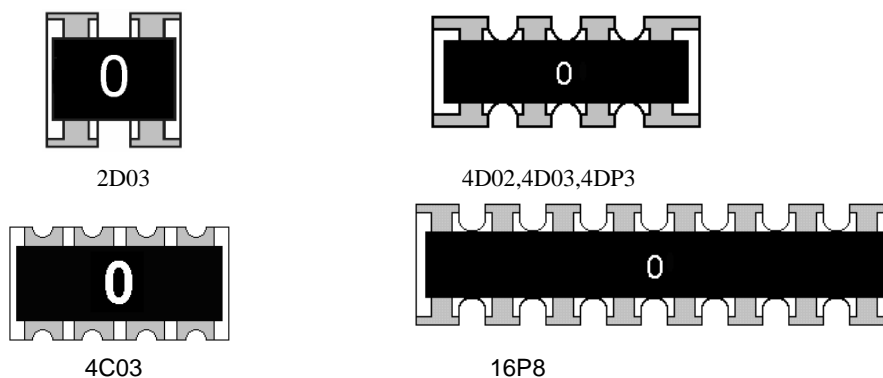

4.5 Normal for 2F01, 4F01 sizes, no marking on the body. 0 Ω resistors is no marking too



5. Dimension

5.1 Equivalent Circuit Diagram:

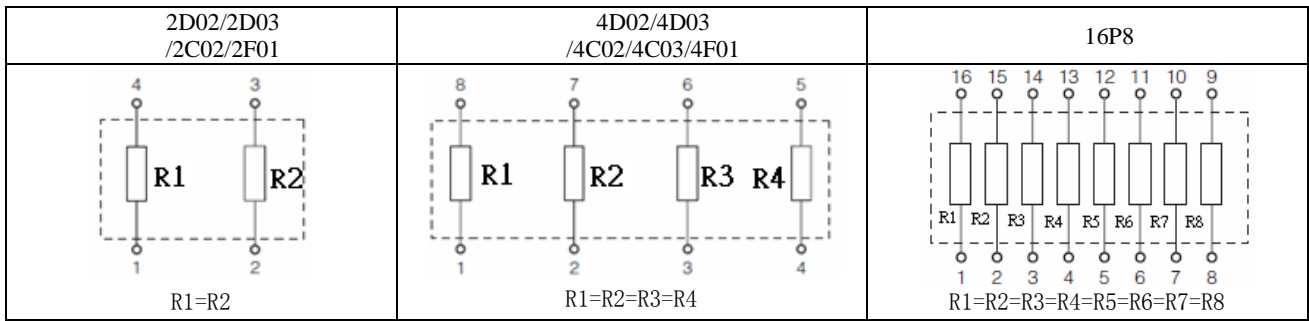

5.2 Dimensions in mm:

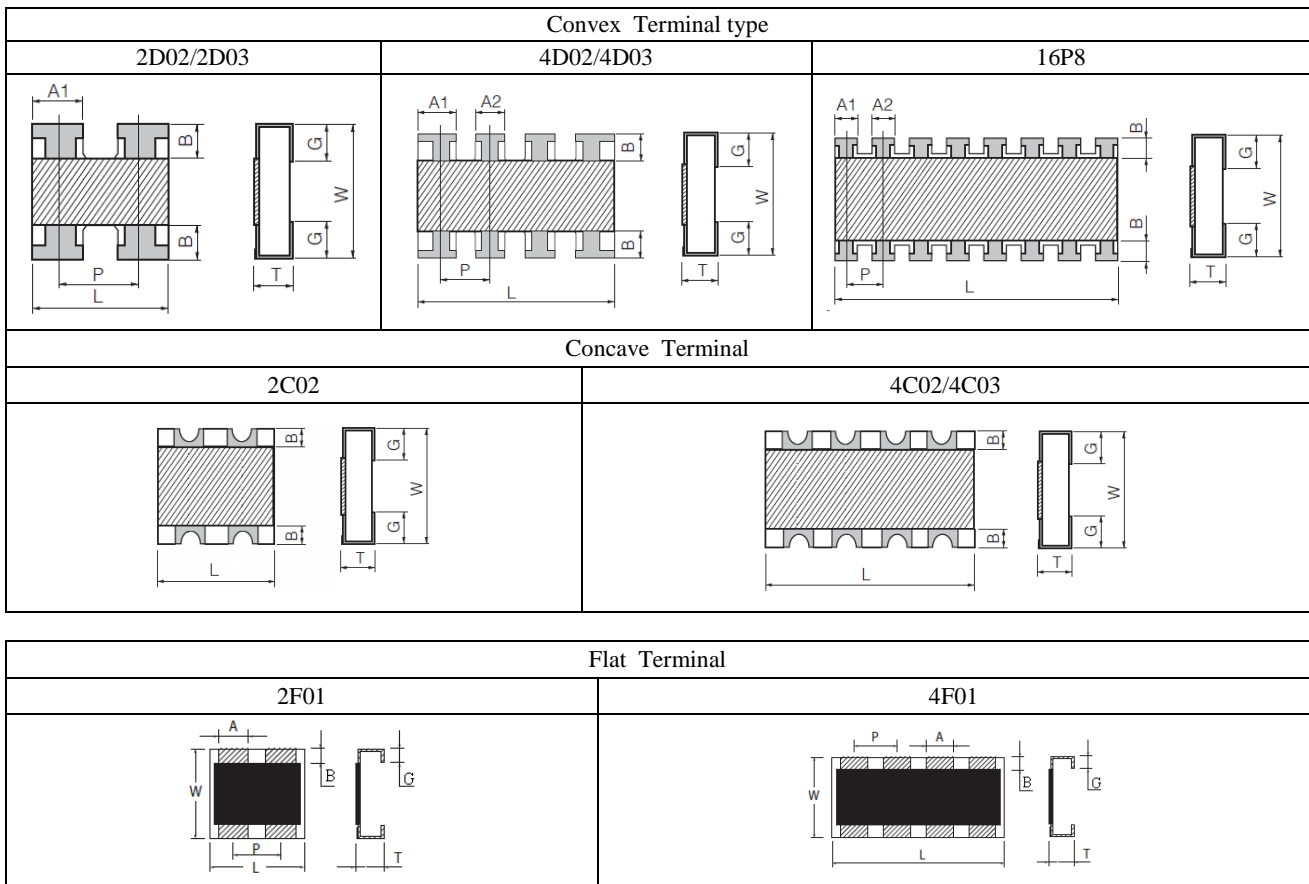

Type	Dimensions (mm)							
	L	W	T	A1	A2	B	P	G
2D02(0402*2)	1.00±0.10	1.00±0.10	0.35±0.10	0.33±0.10	/	0.15±0.05	0.65±0.05	0.25±0.10
4D02(0402*4)	2.00±0.10	1.00±0.10	0.45±0.10	0.40±0.05	0.30±0.05	0.20±0.15	0.50±0.05	0.30±0.15
2D03(0603*2)	1.60±0.15	1.60±0.15	0.50±0.10	0.60±0.15	/	0.30±0.10	0.80±0.05	0.25±0.10
4D03/4DP3(0603*4)	3.20±0.20	1.60±0.20	0.50±0.10	0.65±0.15	0.50±0.15	0.30±0.15	0.80±0.10	0.30±0.15
16P8	4.00±0.20	1.60±0.15	0.45±0.10	0.45±0.05	0.30±0.05	0.30±0.15	0.50±0.05	0.40±0.15
2C02(0402*2)	1.00±0.10	1.00±0.10	0.35±0.10	/	/	0.15±0.10	/	0.30±0.10
4C02(0402*4)	2.00±0.10	1.00±0.10	0.45±0.10	/	/	0.15±0.10	/	0.30±0.10
4C03(0603*4)	3.20±0.20	1.60±0.20	0.60±0.10	/	/	0.30±0.20	/	0.40±0.10
2F01(0201*2)	0.80±0.10	0.60±0.10	0.35±0.10	0.30±0.10	/	0.15±0.10	0.50±0.05	0.15±0.10
4F01(0201*4)	1.40±0.10	0.60±0.10	0.35±0.10	0.20±0.10	/	0.15±0.10	0.40±0.05	0.15±0.10

6. Resistance Range

Type	Rated power	Max Working Voltage	Max Overload Voltage	Dielectric Withstanding Voltage	Resistance Range ±5%±1%	Temperature Coefficient PPM/°C	Operating Temperature	Resistance Value of Jumper	Rated Current of Jumper
2D02	1/16W	50V	100V	100V	10Ω~1MΩ	±200	-55°C~+155°C	<50mΩ	1A
4D02	1/16W	50V	100V	100V	10Ω~1MΩ	±200			
2D03	1/16W	50V	100V	100V	10Ω~1MΩ	±200			
4D03	1/16W	50V	100V	300V	1Ω~1MΩ	≥10Ω:±200 <10Ω:±400			
4DP3	1/10W	50V	100V	300V	1Ω~1MΩ	≥10Ω:±200 <10Ω:±400			
16P8	1/16W	50V	100V	300V	1Ω~1MΩ	≥10Ω:±200 <10Ω:±400			
2C02	1/16W	50V	100V	100V	10Ω~1MΩ	±200			
4C02	1/16W	50V	100V	100V	10Ω~1MΩ	±200			
4C03	1/10W	50V	100V	300V	1Ω~1MΩ	≥10Ω:±200 <10Ω:±400	-55°C~+125°C	<50mΩ	1A
2F01	1/20W	12.5V	25V	/	10Ω~1MΩ	±200			
4F01	1/20W	12.5V	25V	/	10Ω~1MΩ	±200			

7. Soldering pad size recommended

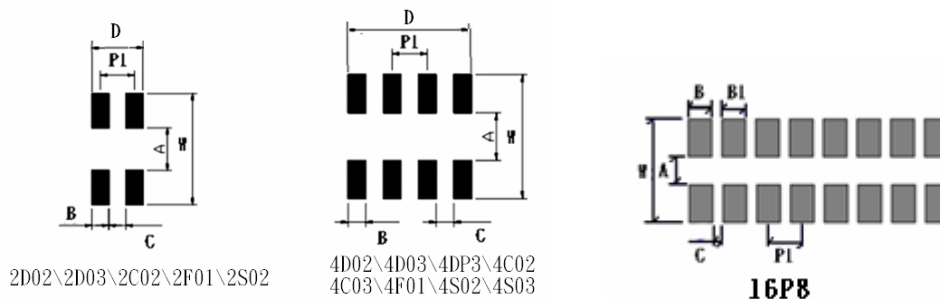

Type	Dimension(mm)							
	A	B	B1	B2	W	C	P1	D
2D02	0.5±0.1	0.33±0.1	/	/	2.0±0.1	0.34±0.1	/	1.0±0.1
4D02	0.5±0.1	0.3±0.1	0.28±0.1	0.28±0.1	2.0±0.1	0.22±0.1	/	1.82±0.1
2D03	0.8±0.1	0.45±0.05	/	/	2.6±0.2	0.35±0.05	0.8±0.05	/
4D03	1.0±0.1	0.4±0.1	0.4±0.1	0.4±0.1	2.6±0.1	0.4±0.1	/	2.8±0.1
4DP3	1.0±0.1	0.4±0.1	0.4±0.1	0.4±0.1	2.6±0.1	0.4±0.1	/	2.8±0.1
16P8	1.0±0.1	0.3±0.1	0.3±0.1	/	2.3±0.1	0.2±0.1	0.5±0.1	/
2C02	0.5±0.1	0.3±0.1	/	/	2.0±0.1	0.2±0.1	/	0.8±0.1
4C02	0.5±0.1	0.3±0.1	0.3±0.1	0.3±0.1	2.0±0.1	0.2±0.1	/	1.8±0.1
4C03	1.0±0.1	0.4±0.1	0.4±0.1	0.4±0.1	2.6±0.1	0.4±0.1	/	2.8±0.1
2F01	0.3±0.1	0.3±0.05	/	/	0.9±0.2	0.2±0.05	0.5±0.05	/
4F01	0.3±0.1	0.2±0.05	/	/	0.9±0.2	0.2±0.05	0.45±0.05	/

8. Derating Curve

Resistors shall have a power rating based on continuous load operation at an ambient temperature from -55°C to 70°C. For temperature in excess of 70°C, the load shall be derate as shown in figure 1

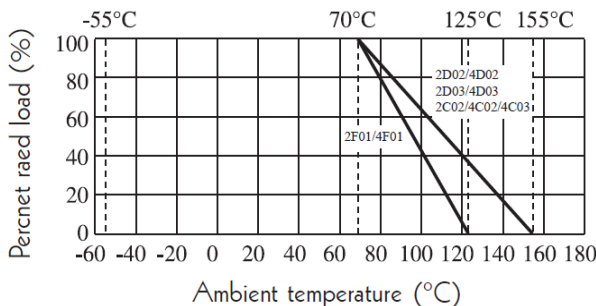

8.1 Voltage rating:

Resistors shall have a rated direct-current (DC) continuous working

voltage or an approximate sine-wave root-mean-square (RMS) alternating-current (AC) continuous working voltage at commercial-line frequency and waveform corresponding to the power rating, as determined from the following formula:

$$RCWV = \sqrt{P \times R}$$

Where: RCWV commercial-line frequency and waveform (Volt.)

P = power rating (WATT.)

R = nominal resistance (OHM)

The overload voltage is 2.5 times RCWV or Max. Overload voltage whichever is less.

In no case shall the rated DC or RMS AC continuous working voltage be greater than the applicable maximum value.

9. Structure

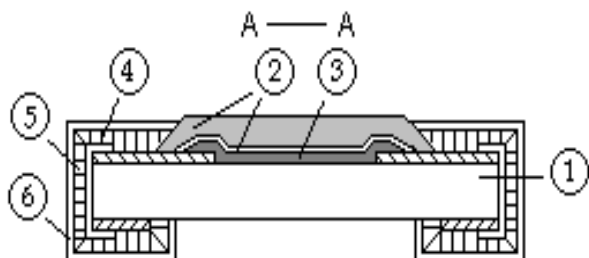

- 1: High purity alumina substrate
- 2: Protective covering
- 3: Resistive covering
- 4: Termination (inner) Ag/Pd
- 5: Termination (between) Ni plating
- 6: Termination (outer) Sn plating

10. Performance Specification

Characteristic	Limits	Test Methods (GB/T5729&JIS-C-5201&IEC60115-1)
Temperature Coefficient	Reference 6.	4.8 Natural resistance changes per temp. Degree centigrade $\frac{R_2 - R_1}{R_1(t_2 - t_1)} \times 10^6 \text{ (PPM/°C)}$ R ₁ : Resistance Value at room temperature (t ₁) ; R ₂ : Resistance at test temperature (t ₂) t ₁ : +25°C or specified room temperature t ₂ : Test temperature (-55°C or 125°C)
*Short-time overload	±(2.0%+0.1Ω) 2F01: 1%:±1.0%+0.05Ω 5%:±2.0%+0.05Ω	4.13 Permanent resistance change after the application of 2.5 times RCWV for 5 seconds.
	* <50mΩ	Apply max overload current for 0Ω

* Insulation resistance	$\geq 1,000 \text{ M}\Omega$	4.6 the measuring voltage shall be ,measured with a direct voltage of $(100\pm 15)\text{v}$ or a voltage equal to the dielectric withstanding voltage., and apply for 1min
Terminal bending	$\pm(1.0\%+0.05\Omega)$	4.33 Twist of test board: Y/x = 3/90 mm for 60Seconds
* Dielectric withstanding voltage	No evidence of flashover mechanical damage, arcing or insulation breaks down.	4.7 Resistors shall be clamped in the trough of a 90°C metallic v-block and shall be tested at ac potential respectively specified in the given list of each product type for 60-70 seconds.
Soldering heat	Resistance change rate is: $\pm(1.0\%+0.05\Omega)$	4.18 Dip the resistor into a solder bath having a temperature of $260^{\circ}\text{C}\pm 5^{\circ}\text{C}$ and hold it for 10 ± 1 seconds.
*Solderability	Coverage must be over 95%.	4.17 The area covered with a new, smooth, clean, shiny and continuous surface free from concentrated pinholes. Temperature of solder: $245\pm 3^{\circ}\text{C}$; Dwell time in solder: 2~3 seconds.
Rapid change of temperature	$\pm(1.0\%\pm 0.05\Omega)$ 2F01: 1%: $\pm 0.5\%+0.05\Omega$ 5%: $\pm 1.0\%\pm 0.05\Omega$	4.19 30 min at lower limit temperature and 30 min at upper limit temperature , 100 cycles.
*Load life in humidity	$\pm(3.0\%\pm 0.1\Omega)$ 2F01: 1%: $\pm (2.0\%+0.1\Omega)$ 5%: $\pm (3.0\%\pm 0.1\Omega)$	7.9 Resistance change after 1,000 hours (1.5 hours “ON”,0.5 hour “OFF”) at RCWV in a humidity chamber controlled at $40^{\circ}\text{C}\pm 2^{\circ}\text{C}$ and 90 to 95% relative humidity.
	* <50mΩ	Apply to rated current for 0Ω
*Load life	$\pm(3.0\%\pm 0.1\Omega)$ 2F01: 1%: $\pm (2.0\%+0.1\Omega)$ 5%: $\pm (3.0\%\pm 0.1\Omega)$	4.25.1 Permanent resistance change after 1,000 hours operating at RCWV with duty cycle 1.5 hours “ON”,0.5 hour “OFF”, at $70^{\circ}\text{C}\pm 2^{\circ}\text{C}$ ambient.
	* <50mΩ	Apply to rated current for 0Ω
*Low Temperature Storage	$\pm(3.0\%\pm 0.1\Omega)$ 2F01: 1%: $\pm (2.0\%+0.1\Omega)$ 5%: $\pm (3.0\%\pm 0.1\Omega)$	IEC 60068-2-1 (Aa) Lower limit temperature, for 2H.
	* <50mΩ	
*High Temperature Exposure	$\pm(3.0\%\pm 0.1\Omega)$ 2F01: 1%: $\pm (2.0\%+0.1\Omega)$ 5%: $\pm (3.0\%\pm 0.1\Omega)$	MIL-STD-202 108A Upper limit temperature , for 1000H.
	* <50mΩ	
*Leaching	No visible damage	J-STD-002 Test D Samples completely immersed for 30 sec in solder bath at 260°C

The resistors of 0Ω only can do the characteristic noted of *

11. Soldering Condition

(This is for recommendation, please customer perform adjustment according to actual application)

11.1 Recommend Reflow Soldering Profile : (solder : Sn96.5 / Ag3 / Cu0.5)

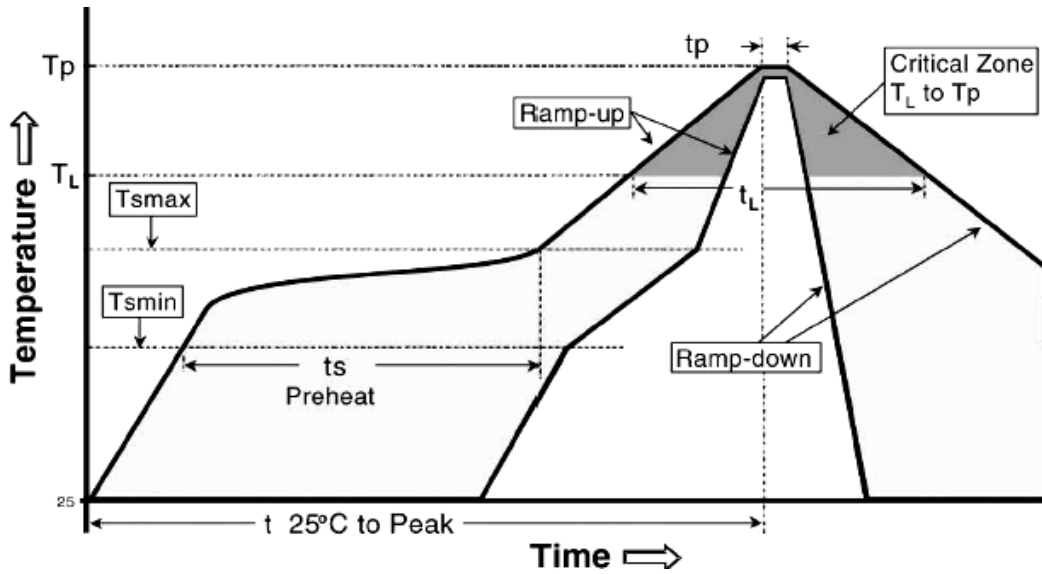

Profile Feature	Lead (Pb)-Free solder
Preheat: Temperature Min ($T_{s_{min}}$) Temperature Max ($T_{s_{max}}$) Time ($T_{s_{min}}$ to $T_{s_{max}}$) (t_s)	150°C 200°C 60 -120 seconds
Average ramp-up rate: ($T_{s_{max}}$ to T_p)	3°C / second max.
Time maintained above : Temperature (T_L) Time (t_L)	217°C 60-150 seconds
Peak Temperature (T_p)	260°C
Time within $+0$ -5 of actual peak Temperature (t_p) ²	10 seconds
Ramp-down Rate	6°C/second max.
Time 25°C to Peak Temperature	8minutes max.

Allowed Re-flow times : 2 times

Remark : To avoid discoloration phenomena of chip on terminal electrodes, please use N2 Re-flow furnace .

11.2 Recommend Wave Soldering Profile : (Apply to 0603 and above size)

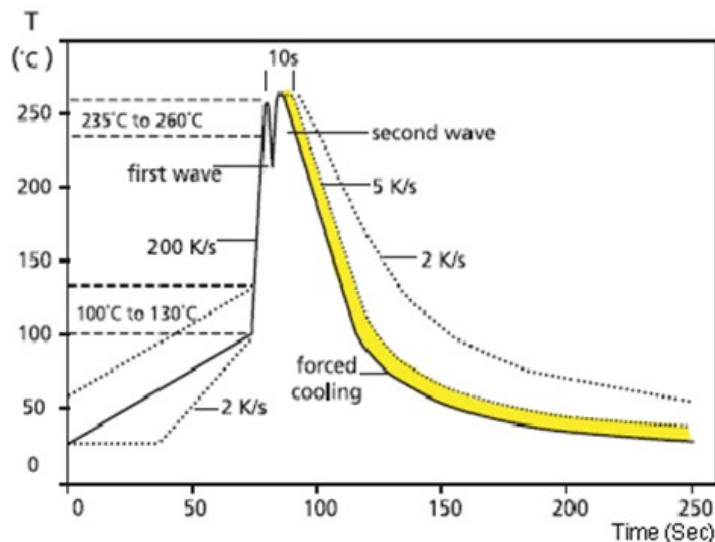

12. Packing of Surface Mount Resistors

12.1 Dimension of Paper Taping : (Unit: mm)

Type	A ±0.2	B ±0.2	C ±0.05	+0.1 ΦD -0	E ±0.1	F ±0.05	G ±0.1	W ±0.2	T ±0.1
2D02/2C02	1.20	1.20	2.00	1.50	1.75	3.50	4.00	8.00	0.45
4D02/4C02	1.20	2.20	2.00	1.50	1.75	3.50	4.00	8.00	0.70
2F01	0.79	1.00	2.00	1.50	1.75	3.50	4.00	8.00	0.50
4F01	0.90	1.70	2.00	1.50	1.75	3.50	4.00	8.00	0.50

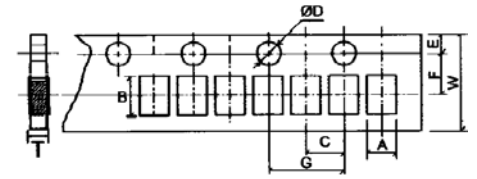

Type	A ±0.2	B ±0.2	C ±0.05	+0.1 ΦD -0	E ±0.1	F ±0.05	G ±0.1	W ±0.2	T ±0.1
4D03/4DP3 /4C03	2.00	3.60	2.00	1.50	1.75	3.50	4.00	8.00	0.83
2D03	1.90	1.90	2.00	1.50	1.75	3.50	4.00	8.00	0.83

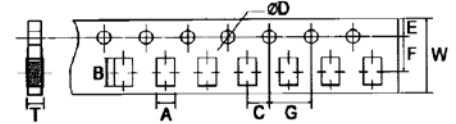

12.2 Dimension of Embossed Taping : (Unit: mm)

Type	A ±0.2	B ±0.2	C ±0.05	+0.1 ΦD -0	+0.25 ΦD1 -0	E ±0.1	F ±0.05	G ±0.1	W ±0.2	T ±0.1
16P8	1.80	4.30	2.00	1.50	1.00	1.75	5.50	4.00	12.00	0.75

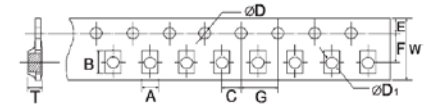

12.3 Dimension of Reel : (Unit: mm)

Type	Qty/Reel	A ± 0.5	B ± 0.5	C ± 0.5	D ± 1.0	M ± 2.0	W ± 1.0
2D02	10,000PCS	2.0	13.0	21.0	60.0	178.0	10.0
4D02	10,000PCS	2.0	13.0	21.0	60.0	178.0	10.0
2D03	5,000PCS	2.0	13.0	21.0	60.0	178.0	10.0
4D03	5,000PCS	2.0	13.0	21.0	60.0	178.0	10.0
4DP3	5,000PCS	2.0	13.0	21.0	60.0	178.0	10.0
16P8	4,000PCS	2.0	13.0	21.0	60.0	178.0	13.8
2C02	10,000PCS	2.0	13.0	21.0	60.0	178.0	10.0
4C02	10,000PCS	2.0	13.0	21.0	60.0	178.0	10.0
4C03	5,000PCS	2.0	13.0	21.0	60.0	178.0	10.0
2F01	15,000PCS	2.0	13.0	21.0	60.0	178.0	10.0
4F01	15,000PCS	2.0	13.0	21.0	60.0	178.0	10.0

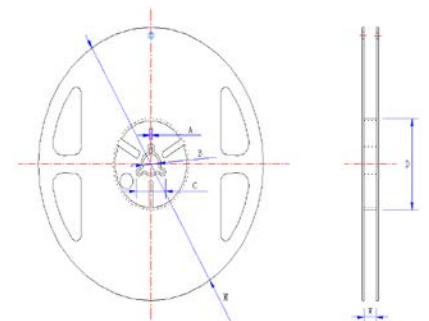

13. Note

13.1. UNI-ROYAL recommend products store in warehouse with temperature between 15 to 35°C under humidity between 25 to 75%RH.

Even under storage conditions recommended above, solder ability of products will be degraded stored over 1 year old.

13.2. Cartons must be placed in correct direction which indicated on carton, otherwise the reel or wire will be deformed.

13.3. Storage conditions as below are inappropriate:

- Stored in high electrostatic environment
- Stored in direct sunshine, rain, snow or condensation.
- Exposed to sea wind or corrosive gases, such as Cl₂, H₂S, NH₃, SO₂, NO₂, Br etc.

14. Record

Version	Description	Page	Date	Amended by	Checked by
1	First version	1~9	Mar.20, 2018	Haiyan Chen	Nana Chen
2	Modify 2F01,4F01 packing quantity	8	Jun.06, 2018	Haiyan Chen	Nana Chen
3	Modify characteristic	6~7	Feb.18, 2019	Haiyan Chen	Yuhua Xu
4	Modify the High Temperature Exposure conditions	7	July.29, 2019	Haiyan Chen	Yuhua Xu
5	Modify the reflow curve and add the wave soldering curve	8	Apr.29, 2020	Haiyan Chen	Yuhua Xu
6	Modify the temperature coefficient test conditions	6	Oct.26, 2022	Haiyan Chen	Yuhua Xu

单击下面可查看定价，库存，交付和生命周期等信息

[>>Uni-Ohm\(厚声\)](#)