



MBR20100C

DIODE

SCHOTTKY BARRIER RECTIFIER

■ **FEATURES**

- * 20 Amps Total (10 Amps Per Diode Leg)
- * Guard Ring for Transient Protection
- * Low Forward Voltage Drop
- * High Surge Capability
- * Low Power Loss/High Efficiency

■ **SYMBOL**

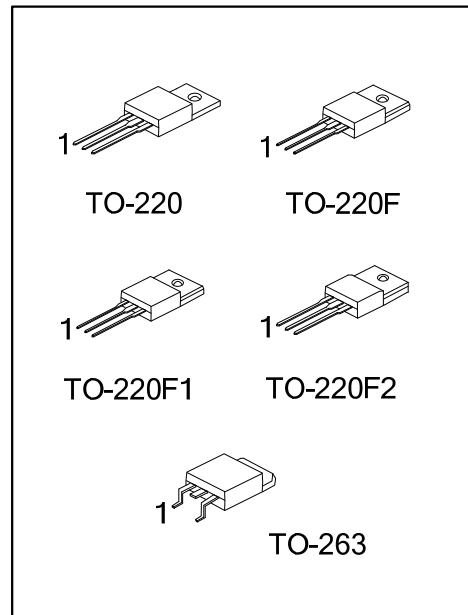
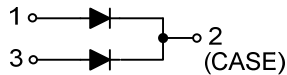

■ **ORDERING INFORMATION**

Ordering Number		Package	Pin Assignment			Packing
Lead Free	Halogen Free		1	2	3	
MBR20100CL-TA3-T	MBR20100CG-TA3-T	TO-220	A	K	A	Tube
MBR20100CL-TF3-T	MBR20100CG-TF3-T	TO-220F	A	K	A	Tube
MBR20100CL-TF1-T	MBR20100CG-TF1-T	TO-220F1	A	K	A	Tube
MBR20100CL-TF2-T	MBR20100CG-TF2-T	TO-220F2	A	K	A	Tube
MBR20100CL-TQ2-T	MBR20100CG-TQ2-T	TO-263	A	K	A	Tube
MBR20100CL-TQ2-R	MBR20100CG-TQ2-R	TO-263	A	K	A	Tape Reel

Note: Pin Assignment: A: Anode K: Cathode

<p>MBR20100CL-TA3-T</p> <p>(1)Packing Type</p> <p>(2)Package Type</p> <p>(3)Green Package</p>	<p>(1) T: Tube, R: Tape Reel</p> <p>(2) TA3: TO-220, TF3: TO-220F, TF1: TO-220F1 TF2: TO-220F2, TQ2: TO-263</p> <p>(3) L: Lead Free, G: Halogen Free and Lead Free</p>
---	--

■ **MARKING**

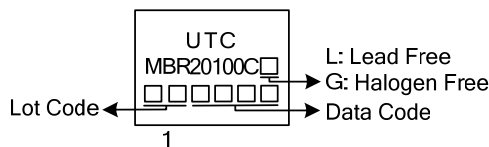

■ ABSOLUTE MAXIMUM RATINGS (T_A=25°C, unless otherwise specified)

PARAMETER		SYMBOL	RATINGS	UNIT
Maximum Repetitive Peak Reverse Voltage		V _{RRM}	100	V
Maximum DC Blocking Voltage		V _R	100	V
Working Peak Reverse Voltage		V _{RWM}	100	V
Maximum PMS Reverse Voltage		V _{R(RMS)}	70	V
Average Forward Rectified Output Current	Per Leg	I _O	10	A
	Total		20	A
Non-Repetitive Peak Forward Surge Current 8.3ms Single Half-Sine-Wave		I _{FSM}	150	A
Junction Capacitance (Note 4)		C _J	1000	pF
Operating Temperature		T _J	-55 ~ +150	°C
Storage Temperature		T _{STG}	-55 ~ +150	°C

■ THERMAL DATA (Pre Diode)

PARAMETER		SYMBOL	RATINGS	UNIT
Junction to Ambient		θ _{JA}	55	°C/W
Junction to Case	TO-220/TO-263	θ _{JC}	2	°C/W
	TO-220F/TO-220F1		2.5	°C/W
	TO-220F2			

■ ELECTRICAL CHARACTERISTICS

PARAMETER	SYMBOL	TEST CONDITIONS	MIN	TYP	MAX	UNIT
Instantaneous Forward Voltage Drop (Note 3)	V _F	I _F =10A, T _C =25°C			0.85	V
		I _F =10A, T _C =125°C			0.75	
Instantaneous Reverse Current (Note 3)	I _R	Rated DC Voltage, T _C =25°C			0.15	mA
		Rated DC Voltage, T _C =125°C		0.5	10	

Notes: 1. Absolute maximum ratings are those values beyond which the device could be permanently damaged.

Absolute maximum ratings are stress ratings only and functional device operation is not implied.

2. 2.0μs Pulse Width, f = 1.0KHz.
3. Pulse Test: Pulse Width=300μs, Duty Cycle ≤ 2.0%.
4. Applied V_R = 4.0V and f = 1.0MHz.

TYPICAL CHARACTERISTICS

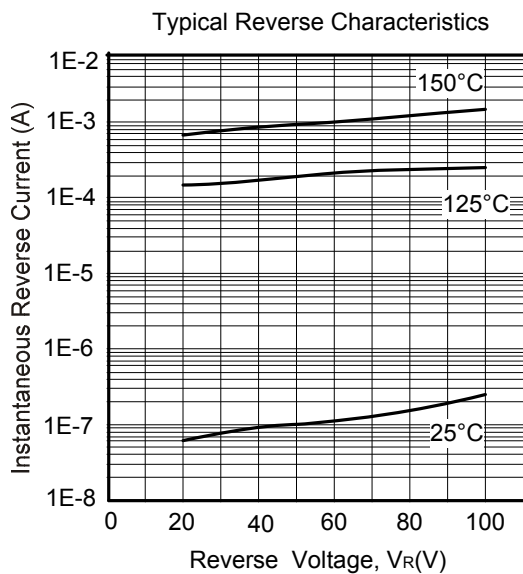
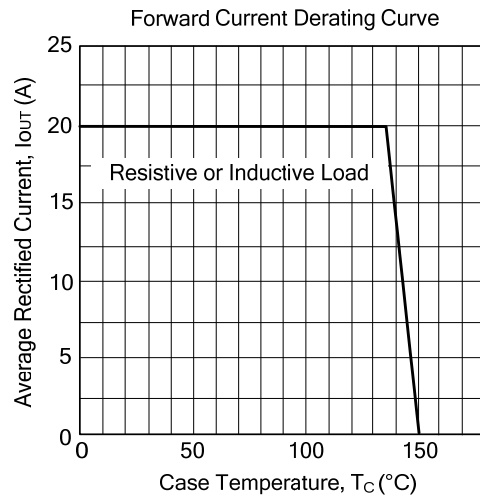
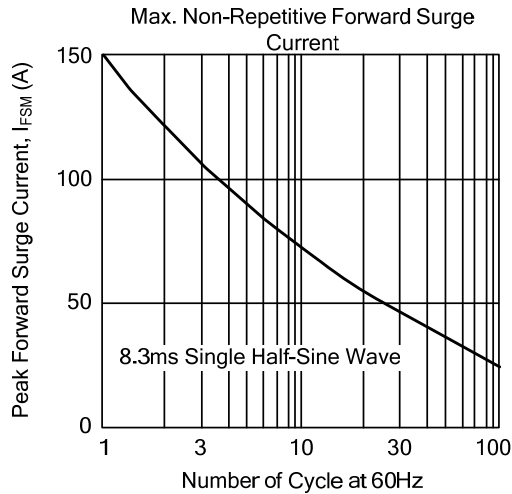
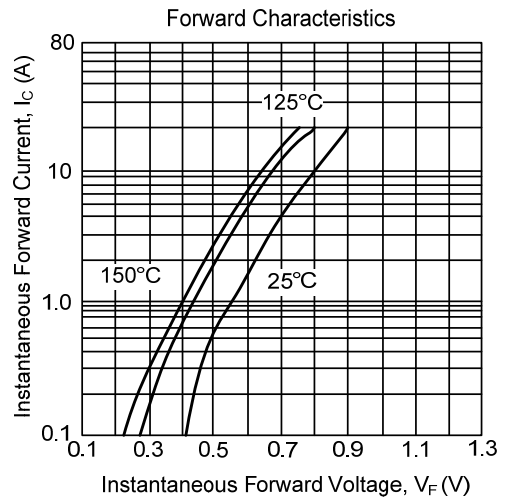
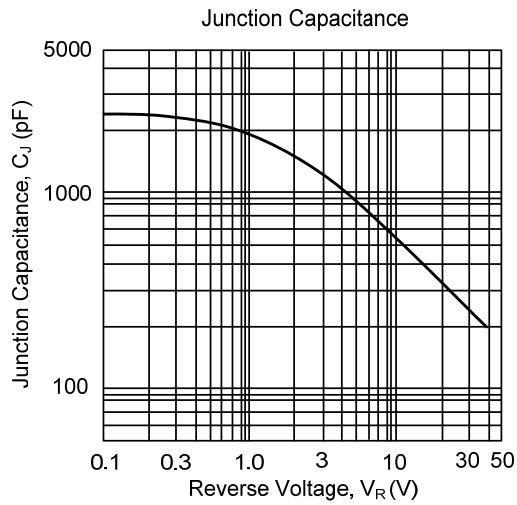

UTC assumes no responsibility for equipment failures that result from using products at values that exceed, even momentarily, rated values (such as maximum ratings, operating condition ranges, or other parameters) listed in products specifications of any and all UTC products described or contained herein. UTC products are not designed for use in life support appliances, devices or systems where malfunction of these products can be reasonably expected to result in personal injury. Reproduction in whole or in part is prohibited without the prior written consent of the copyright owner. The information presented in this document does not form part of any quotation or contract, is believed to be accurate and reliable and may be changed without notice.

单击下面可查看定价，库存，交付和生命周期等信息

[>>UTC\(友顺\)](#)