



MPSA44/45

NPN SILICON TRANSISTOR

HIGH VOLTAGE TRANSISTOR

■ FEATURES

- * Collector-Emitter Voltage:
- * $V_{CEO}=400V$ (UTC **MPSA44**)
- * $V_{CEO}=350V$ (UTC **MPSA45**)
- * Collector Current up to 300mA

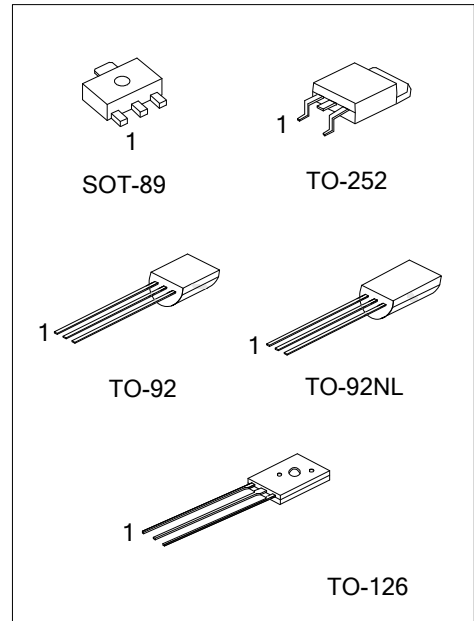

■ ORDERING INFORMATION

Ordering Number		Package	Pin Assignment			Packing
Lead Free	Halogen Free		1	2	3	
MPSA44L-AB3-R	MPSA44G-AB3-R	SOT-89	B	C	E	Tape Reel
MPSA44L-AN3-R	MPSA44G-TN3-R	TO-252	B	C	E	Tape Reel
MPSA44L-T60-K	MPSA44G-T60-K	TO-126	B	C	E	Bulk
MPSA44L-T92-B	MPSA44G-T92-B	TO-92	E	B	C	Tape Box
MPSA44L-T92-K	MPSA44G-T92-K	TO-92	E	B	C	Bulk
MPSA44L-T92-A-B	MPSA44G-T92-A-B	TO-92	E	C	B	Tape Box
MPSA44L-T92-A-K	MPSA44G-T92-A-K	TO-92	E	C	B	Bulk
MPSA44L-T9N-B	MPSA44G-T9N-B	TO-92NL	E	C	B	Tape Box
MPSA44L-T9N-K	MPSA44G-T9N-K	TO-92NL	E	C	B	Bulk
MPSA45L-AB3-R	MPSA45G-AB3-R	SOT-89	B	C	E	Tape Reel
MPSA45L-T92-B	MPSA45G-T92-B	TO-92	E	B	C	Tape Box
MPSA45L-T92-K	MPSA45G-T92-K	TO-92	E	B	C	Bulk
MPSA45L-T9N-B	MPSA45G-T9N-B	TO-92NL	E	B	C	Tape Box
MPSA45L-T9N-K	MPSA45G-T9N-K	TO-92NL	E	B	C	Bulk

Note: Pin Assignment: B: Base C: Collector E: Emitter

<p>MPSA44G-T92-A-B</p>	<p>(1) Packing Type (2) Pin Assignment (3) Package Type (4) Green Package</p>	<p>(1) B: Tape Box, K: Bulk, R: Tape Reel (2) refer to Pin Assignment (3) AB3: SOT-89, TN3: TO-252, T60: TO-126, T92: TO-92, T9N: TO-92NL (4) G: Halogen Free and Lead Free, L: Lead Free</p>
------------------------	---	---

MARKING

Package	MPSA44	MPSA45
SOT-89	<p> Date Code L: Lead Free G: Halogen Free </p>	<p> Date Code L: Lead Free G: Halogen Free </p>
TO-252	<p> Lot Code Date Code L: Lead Free G: Halogen Free </p>	-
TO-126	<p> Date Code L: Lead Free G: Halogen Free </p>	-
TO-92	<p> Pin Code Date Code L: Lead Free G: Halogen Free </p>	<p> Date Code L: Lead Free G: Halogen Free </p>
TO-92NL	<p> L: Lead Free G: Halogen Free Date Code </p>	<p> L: Lead Free G: Halogen Free Date Code </p>

■ ABSOLUTE MAXIMUM RATING

PARAMETER		SYMBOL	RATINGS	UNIT
Collector-Base Voltage	MPSA44	V_{CBO}	500	V
	MPSA45		400	
Collector-Emitter Voltage	MPSA44	V_{CEO}	400	V
	MPSA45		350	
Emitter-Base Voltage		V_{EBO}	6	V
Collector Current		I_C	300	mA
Collector Current (Peak)		I_{CM}	1000	mA
Collector Dissipation($T_A=25^{\circ}C$)	SOT-89	P_C	500	mW
	TO-252		1400	
	TO-126		1200	
	TO-92		625	
	TO-92NL			
Junction Temperature		T_J	+150	$^{\circ}C$
Operating Temperature		T_{OPR}	-40 ~ +125	$^{\circ}C$
Storage Temperature		T_{STG}	-40 ~ +150	$^{\circ}C$

Note: Absolute maximum ratings are those values beyond which the device could be permanently damaged. Absolute maximum ratings are stress ratings only and functional device operation is not implied.

■ THERMAL DATA

PARAMETER		SYMBOL	RATINGS	UNIT
Junction to Ambient	SOT-89	θ_{JA}	250	$^{\circ}C/W$
	TO-252		89	$^{\circ}C/W$
	TO-126		105	$^{\circ}C/W$
	TO-92		200	
	TO-92NL			$^{\circ}C/W$
Junction to Case	SOT-89	θ_{JC}	167	$^{\circ}C/W$
	TO-252		4	$^{\circ}C/W$
	TO-126		5	$^{\circ}C/W$
	TO-92		100	
	TO-92NL			$^{\circ}C/W$

■ **ELECTRICAL CHARACTERISTICS** ($T_J=25^\circ\text{C}$, unless otherwise specified)

PARAMETER		SYMBOL	TEST CONDITIONS	MIN	TYP	MAX	UNIT
Collector-Base Breakdown Voltage	MPSA44	BV_{CBO}	$I_C=100\mu\text{A}, I_E=0$	500			V
	MPSA45			400			
Collector-Emitter Breakdown Voltage	MPSA44	BV_{CEO}	$I_C=1\text{mA}, I_B=0$	400			V
	MPSA45			350			
Emitter-Base Breakdown Voltage		BV_{EBO}	$I_E=100\mu\text{A}, I_C=0$	6			V
Collector-Base Cutoff Current	MPSA44	I_{CBO}	$V_{CB}=400\text{V}, I_E=0$			0.1	μA
	MPSA45		$V_{CB}=320\text{V}, I_E=0$			0.1	
Collector Cutoff Current	MPSA44	I_{CES}	$V_{CE}=400\text{V}, I_B=0$			0.5	μA
	MPSA45		$V_{CE}=320\text{V}, I_B=0$			0.5	
Emitter-Base Cutoff Current		I_{EBO}	$V_{EB}=4\text{V}, I_C=0$			0.1	μA
ON CHARACTERISTICS							
DC Current Gain (Note)		h_{FE}	$V_{CE}=10\text{V}, I_C=1\text{mA}$	40		240	
			$V_{CE}=10\text{V}, I_C=10\text{mA}$	82		240	
			$V_{CE}=10\text{V}, I_C=50\text{mA}$	45		240	
			$V_{CE}=10\text{V}, I_C=100\text{mA}$	40		240	
Collector-Emitter Saturation Voltage		$V_{CE(SAT)}$	$I_C=1\text{mA}, I_B=0.1\text{mA}$			0.4	V
			$I_C=10\text{mA}, I_B=1\text{mA}$			0.5	
			$I_C=50\text{mA}, I_B=5\text{mA}$			0.75	
Base-Emitter Saturation Voltage		$V_{BE(SAT)}$	$I_C=10\text{mA}, I_B=1\text{mA}$			0.75	V
SMALL-SIGNAL CHARACTERISTICS							
Current Gain Bandwidth Product		f_T	$V_{CE}=20\text{V}, I_C=10\text{mA}, f=100\text{MHz}$	50			MHz
Output Capacitance		C_{OB}	$V_{CB}=20\text{V}, I_E=0, f=1\text{MHz}$			7	pF

Note: Pulse test: $PW < 300\mu\text{s}$, Duty Cycle $< 2\%$

■ TYPICAL CHARACTERISTICS

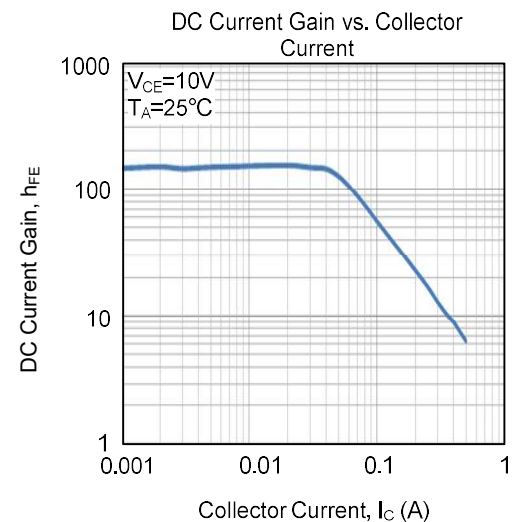
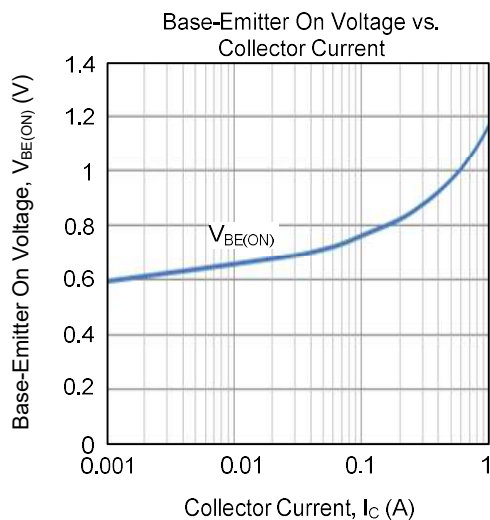
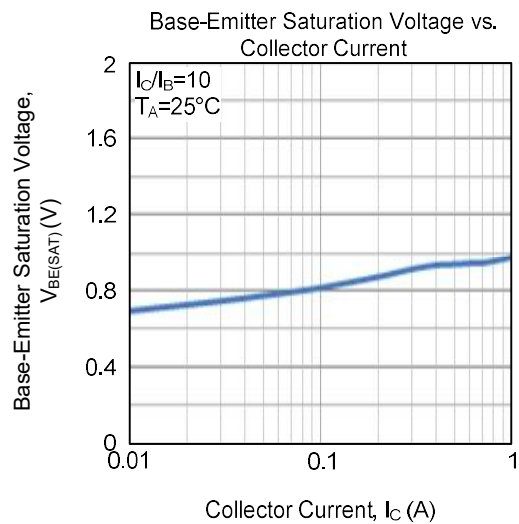
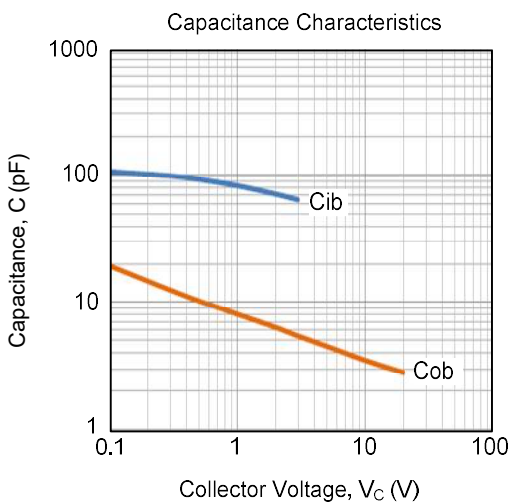
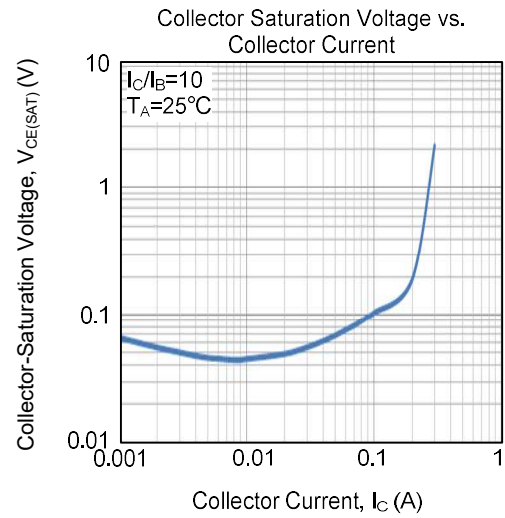
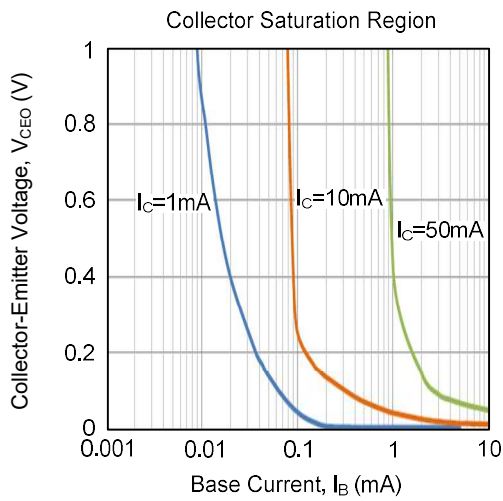

■ TYPICAL CHARACTERISTICS

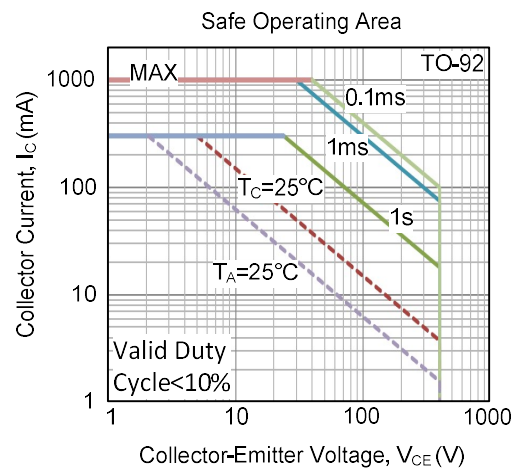
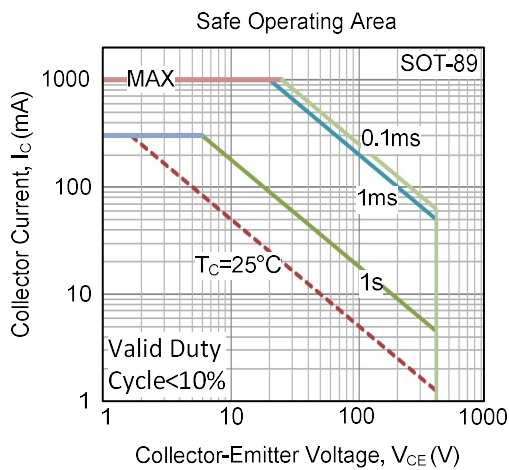
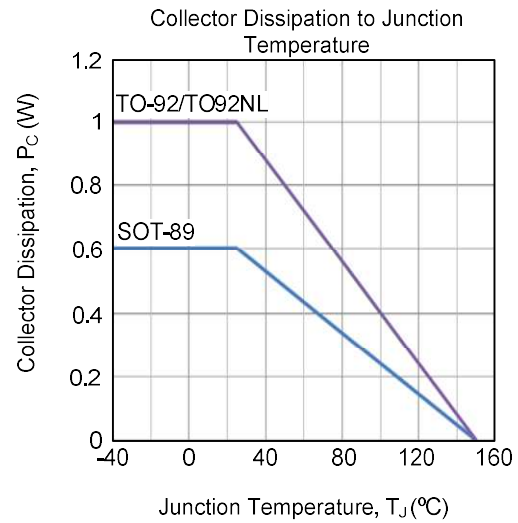
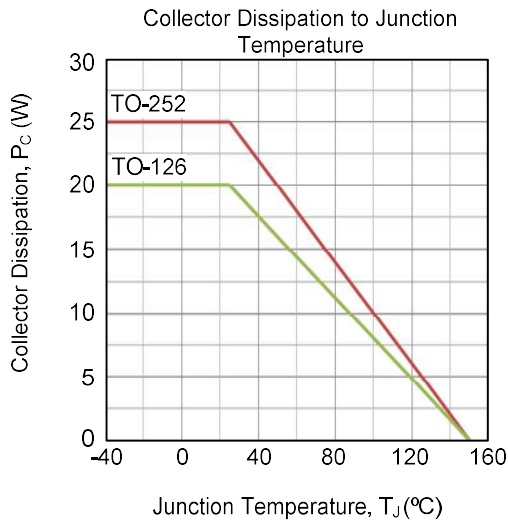

UTC assumes no responsibility for equipment failures that result from using products at values that exceed, even momentarily, rated values (such as maximum ratings, operating condition ranges, or other parameters) listed in products specifications of any and all UTC products described or contained herein. UTC products are not designed for use in life support appliances, devices or systems where malfunction of these products can be reasonably expected to result in personal injury. Reproduction in whole or in part is prohibited without the prior written consent of the copyright owner. UTC reserves the right to make changes to information published in this document, including without limitation specifications and product descriptions, at any time and without notice. This document supersedes and replaces all information supplied prior to the publication hereof.

单击下面可查看定价，库存，交付和生命周期等信息

[>>UTC\(友顺\)](#)