



MPSA94

PNP SILICON TRANSISTOR

HIGH VOLTAGE TRANSISTOR

FEATURES

- * Collector-Emitter voltage: $V_{CE0}=-400V$
- * Low collector-Emitter saturation voltage

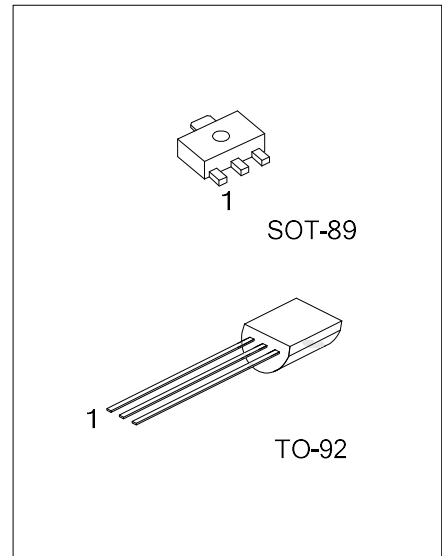

ORDERING INFORMATION

Ordering Number		Package	Pin Assignment			Packing
Lead Free	Halogen Free		1	2	3	
MPSA94L-AB3-R	MPSA94G-AB3-R	SOT-89	B	C	E	Tape Reel
MPSA94L-T92-B	MPSA94G-T92-B	TO-92	E	B	C	Tape Box
MPSA94L-T92-K	MPSA94G-T92-K	TO-92	E	B	C	Bulk

Note: Pin Assignment: B: Base C: Collector E: Emitter

<p>MPSA94G-AB3-R</p> <p>(1)Packing Type (2)Package Type (3)Green Package</p>	<p>(1) R: Tape Reel, B: Tape Box, K: Bulk (2) AB3: SOT-89, T92: TO-92 (3) G: Halogen Free and Lead Free, L: Lead Free</p>
--------------------------------------------------------------------------------------	-----------------------------------------------------------------------------------------------------------------------------------

MARKING

SOT-89	TO-92

■ **ABSOLUTE MAXIMUM RATING** (Operating temperature range applies unless otherwise specified)

PARAMETER	SYMBOL	RATINGS	UNIT
Collector-Base Voltage	V_{CBO}	-400	V
Collector-Emitter Voltage	V_{CEO}	-400	V
Emitter-Base Voltage	V_{EBO}	-6	V
Collector Power Dissipation ($T_A=25^\circ\text{C}$)	SOT-89	500	mW
	TO-92	625	mW
Collector Current	I_C	-300	mA
Junction Temperature	T_J	+150	$^\circ\text{C}$
Storage Temperature	T_{STG}	-40 ~ +150	$^\circ\text{C}$

Note Absolute maximum ratings are those values beyond which the device could be permanently damaged.

Absolute maximum ratings are stress ratings only and functional device operation is not implied.

■ **ELECTRICAL CHARACTERISTICS** ($T_J=25^\circ\text{C}$, unless otherwise specified)

PARAMETER	SYMBOL	TEST CONDITIONS	MIN	TYP	MAX	UNIT
Collector-Base Breakdown Voltage	BV_{CBO}	$I_C=-100\mu\text{A}, I_E=0$	-400			V
Collector-Emitter Breakdown Voltage	BV_{CEO}	$I_C=-1\text{mA}, I_B=0$	-400			V
Collector-Emitter Breakdown Voltage	BV_{CES}	$I_C=-100\mu\text{A}, V_{BE}=0$	-400			V
Emitter-Base Breakdown Voltage	BV_{EBO}	$I_E=-100\mu\text{A}, I_C=0$	-5			V
Collector Cut-off Current	I_{CBO}	$V_{CB}=-300\text{V}, I_E=0$			-100	nA
Collector Cut-off Current	I_{CES}	$V_{CE}=-400\text{V}, V_{BE}=0$			-1	μA
Emitter Cut-off Current	I_{EBO}	$V_{EB}=-4\text{V}, I_C=0$			-100	nA
DC Current Gain(note)	h_{FE}	$V_{CE}=-10\text{V}, I_C=-1\text{mA}$	60		300	
		$V_{CE}=-10\text{V}, I_C=-10\text{mA}$	70			
		$V_{CE}=-10\text{V}, I_C=-50\text{mA}$	70			
		$V_{CE}=-10\text{V}, I_C=-100\text{mA}$	40			
Collector-Emitter Saturation Voltage	$V_{CE(SAT)}$	$I_C=-10\text{mA}, I_B=-1\text{mA}$ $I_C=-50\text{mA}, I_B=-5\text{mA}$			-0.20 -0.5	V
Base-Emitter Saturation Voltage	$V_{BE(SAT)}$	$I_C=-10\text{mA}, I_B=-1\text{mA}$			-0.75	V
Output Capacitance	C_{ob}	$V_{CB}=-20\text{V}, I_E=0, f=1\text{MHz}$			7	pF

Note: Pulse test: Pulse Width<300 μs , Duty Cycle<2%.

TYPICAL CHARACTERISTICS

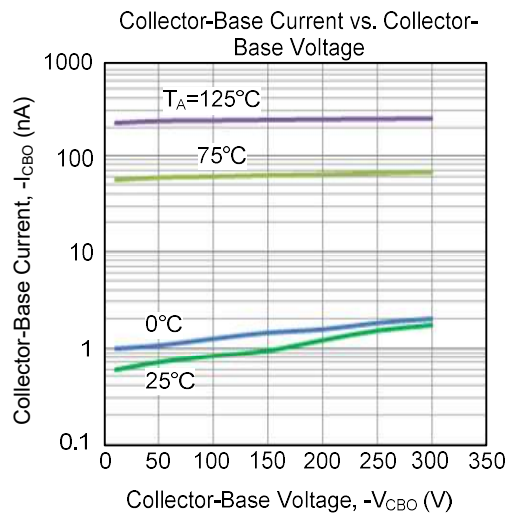
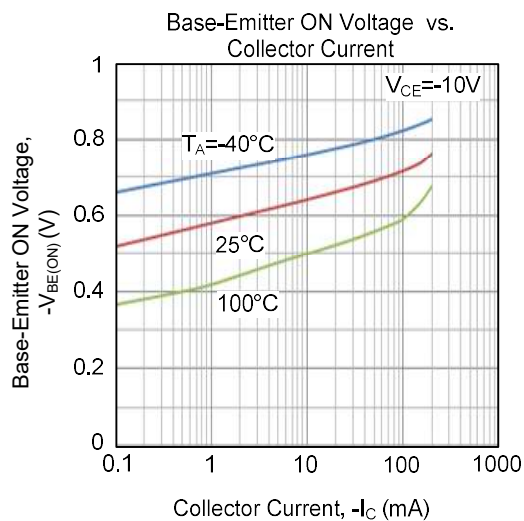
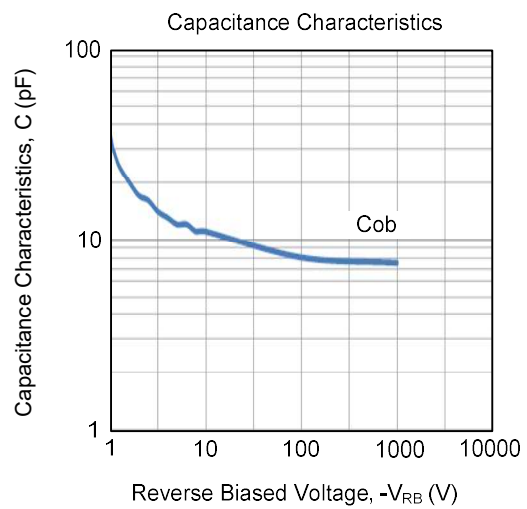
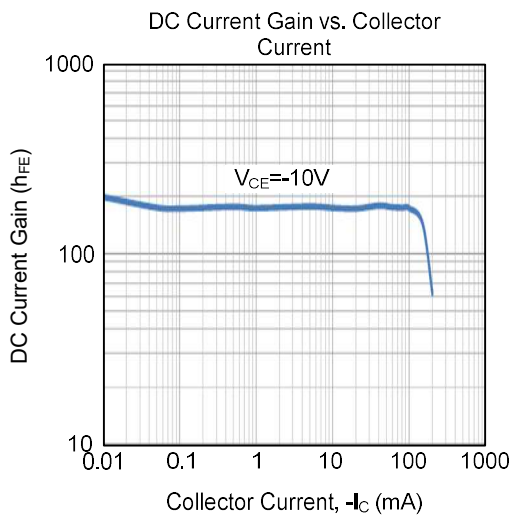
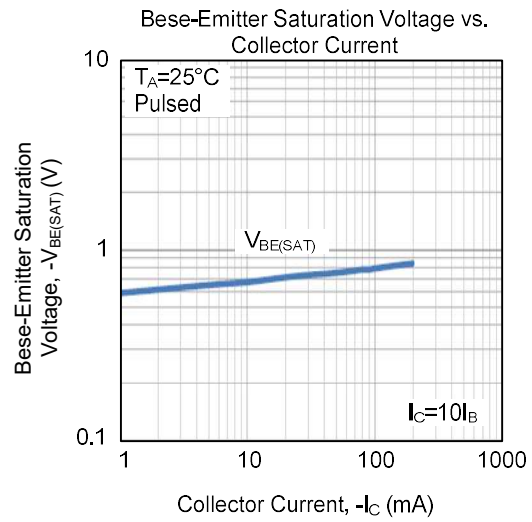
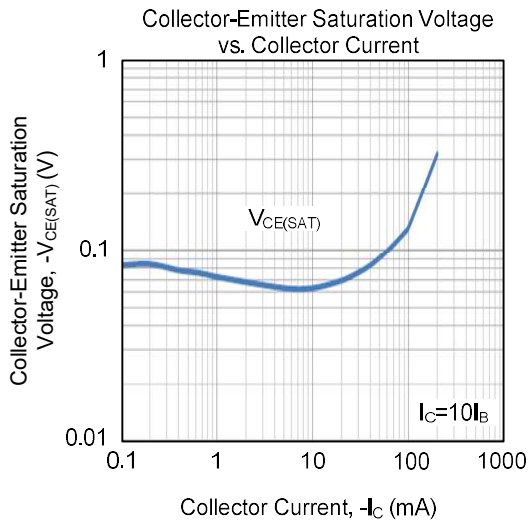

■ TYPICAL CHARACTERISTICS

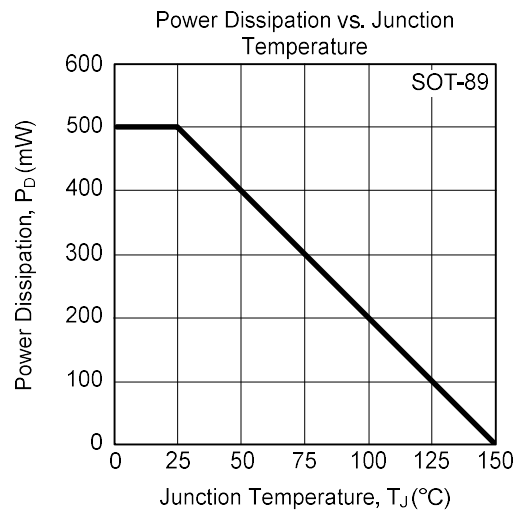
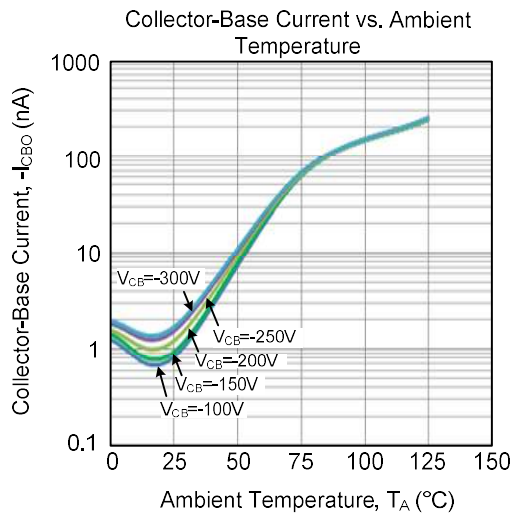

UTC assumes no responsibility for equipment failures that result from using products at values that exceed, even momentarily, rated values (such as maximum ratings, operating condition ranges, or other parameters) listed in products specifications of any and all UTC products described or contained herein. UTC products are not designed for use in life support appliances, devices or systems where malfunction of these products can be reasonably expected to result in personal injury. Reproduction in whole or in part is prohibited without the prior written consent of the copyright owner. UTC reserves the right to make changes to information published in this document, including without limitation specifications and product descriptions, at any time and without notice. This document supersedes and replaces all information supplied prior to the publication hereof.

单击下面可查看定价，库存，交付和生命周期等信息

[>>UTC\(友顺\)](#)