



# UT3N06

*Power MOSFET*

## N-CHANNEL ENHANCEMENT MODE POWER MOSFET

■ DESCRIPTION

The UTC **UT3N06** is an N-channel power MOSFET providing very low on-resistance. It has high efficiency and perfect cost-effectiveness. It can be generally applied in the commercial and industrial fields.

■ FEATURES

\* Simple drive requirement

■ SYMBOL

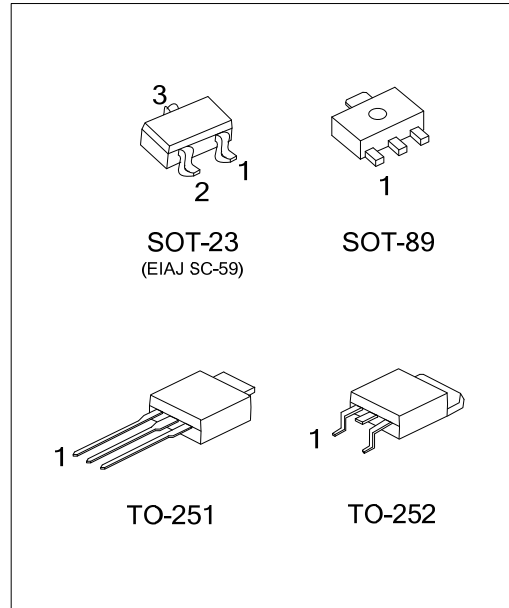
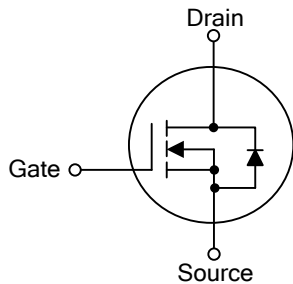

■ ORDERING INFORMATION

Ordering Number		Package	Pin Assignment			Packing
Lead Free	Halogen Free		1	2	3	
-	UT3N06G-AB3-R	SOT-89	G	D	S	Tape Reel
-	UT3N06G-AE3-R	SOT-23	S	G	D	Tape Reel
UT3N06L-TM3-T	UT3N06G-TM3-T	TO-251	G	D	S	Tube
UT3N06L-TN3-R	UT3N06G-TN3-R	TO-252	G	D	S	Tape Reel

Note: Pin Assignment: G: Gate D: Drain S: Source

<p>UT3N06G-AB3-R</p> <p>(1) Packing Type (2) Package Type (3) Green Package</p>	<p>(1) T: Tube, R: Tape Reel (2) AB3: SOT-89, AE3: SOT-23, TM3: TO-251 TN3: TO-252 (3) G: Halogen Free and Lead Free, L: Lead Free</p>
---	--

■ MARKING

SOT-89	SOT-23	TO-251 / TO-252
<p>1</p>		<p>1</p>

## ■ ABSOLUTE MAXIMUM RATINGS

PARAMETER	SYMBOL	RATINGS	UNIT
Drain-Source Voltage	$V_{DSS}$	60	V
Gate-Source Voltage	$V_{GSS}$	$\pm 20$	V
Continuous Drain Current ( $V_{GS}=4.5V$ , $T_A=25^\circ C$ ) (Note 2)	$I_D$	3.0	A
Pulsed Drain Current (Note 3, 4)	$I_{DM}$	10	A
Power Dissipation ( $T_A=25^\circ C$ )	SOT-23	0.35	W
	SOT-89	0.69	W
	TO-251/TO-252	1.13	W
Junction Temperature	$T_J$	+150	$^\circ C$
Storage Temperature	$T_{STG}$	-55 ~ +150	$^\circ C$

- Notes: 1. Absolute maximum ratings are those values beyond which the device could be permanently damaged. Absolute maximum ratings are stress ratings only and functional device operation is not implied.  
 2. Surface mounted on 1 in<sup>2</sup> copper pad of FR4 board; 270 $^\circ C/W$  when mounted on min. copper pad  
 3. Pulse width limited by  $T_{J(MAX)}$   
 4. Pulse width  $\leq 300\mu s$ , duty cycle  $\leq 2\%$

## ■ THERMAL DATA

PARAMETER	SYMBOL	RATING	UNIT
Junction to Ambient	SOT-23	350	$^\circ C/W$
	SOT-89	180	$^\circ C/W$
	TO-251/TO-252	110	$^\circ C/W$

## ■ ELECTRICAL CHARACTERISTICS ( $T_J = 25^\circ C$ , unless otherwise specified)

PARAMETER	SYMBOL	TEST CONDITIONS	MIN	TYP	MAX	UNIT
<b>OFF CHARACTERISTICS</b>						
Drain-Source Breakdown Voltage	$BV_{DSS}$	$V_{GS}=0V$ , $I_D=250\mu A$	60			V
Breakdown Voltage Temperature Coefficient	$\frac{\Delta BV_{DSS}}{\Delta T_J}$	Reference to $25^\circ C$ , $I_D=1mA$		0.05		$V/^\circ C$
Drain-Source Leakage Current	$I_{DSS}$	$V_{DS}=60V$ , $V_{GS}=0V$			10	$\mu A$
Gate-Source Leakage Current	$I_{GSS}$	$V_{GS}=\pm 20V$			$\pm 100$	nA
<b>ON CHARACTERISTICS</b>						
Gate Threshold Voltage	$V_{GS(TH)}$	$V_{DS}=V_{GS}$ , $I_D=250\mu A$	1.0		3.0	V
Drain to Source On-state Resistance	$R_{DS(ON)}$	$V_{GS}=10V$ , $I_D=3A$			90	m $\Omega$
		$V_{GS}=4.5V$ , $I_D=2A$			120	m $\Omega$
<b>DYNAMIC PARAMETERS</b>						
Input Capacitance	$C_{ISS}$	$V_{DS}=25V$ , $V_{GS}=0V$ , $f=1.0MHz$		490	780	pF
Output Capacitance	$C_{OSS}$			55		pF
Reverse Transfer Capacitance	$C_{RSS}$			40		pF
<b>SWITCHING PARAMETERS</b>						
Turn-ON Delay Time (Note)	$t_{D(ON)}$	$V_{GS}=10V$ , $V_{DS}=30V$ , $I_D=1A$ , $R_D=30\Omega$ , $R_G=3.3\Omega$		6		ns
Turn-ON Rise Time	$t_R$			5	42	ns
Turn-OFF Delay Time	$t_{D(OFF)}$			16		ns
Turn-OFF Fall-Time	$t_F$			3	58	ns
Total Gate Charge (Note)	$Q_G$	$V_{GS}=4.5V$ , $V_{DS}=48V$ , $I_D=3A$		6	10	nC
Gate Source Charge	$Q_{GS}$			1.6		nC
Gate Drain Charge	$Q_{GD}$			3		nC
<b>SOURCE- DRAIN DIODE RATINGS AND CHARACTERISTICS</b>						
Drain-Source Diode Forward Voltage (Note)	$V_{SD}$	$I_S=1.2A$ , $V_{GS}=0V$			1.2	V
Reverse Recovery Time	$t_{rr}$	$I_S=3A$ , $V_{GS}=0V$ , $dI/dt=100A/\mu s$		25		ns
Reverse Recovery Charge	$Q_{RR}$			26		nC

Note: Pulse width  $\leq 300\mu s$ , duty cycle  $\leq 2\%$ .

## ■ TEST WAVEFORMS

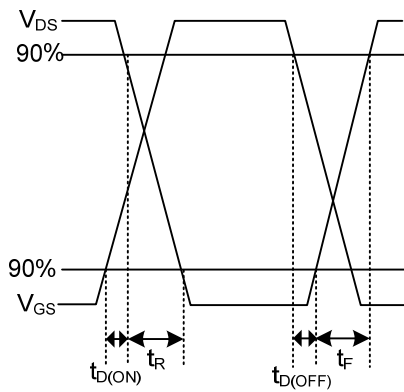

Switching Time Waveform

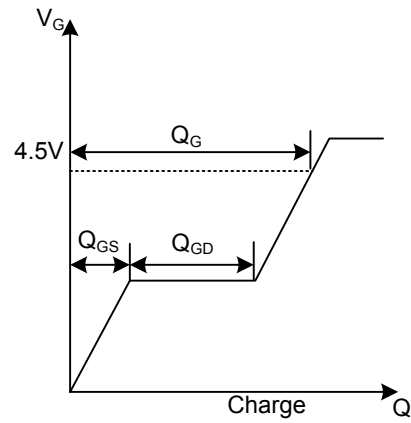

Gate Charge Waveform

■ TYPICAL CHARACTERISTICS

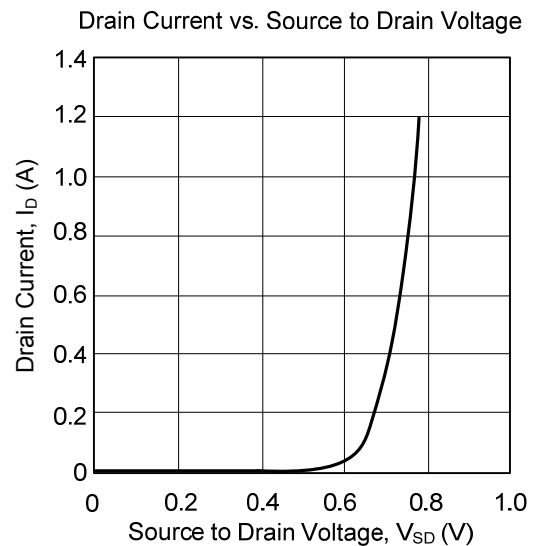
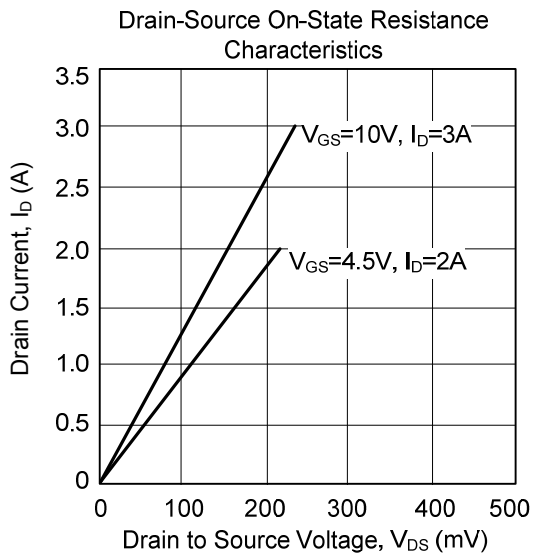
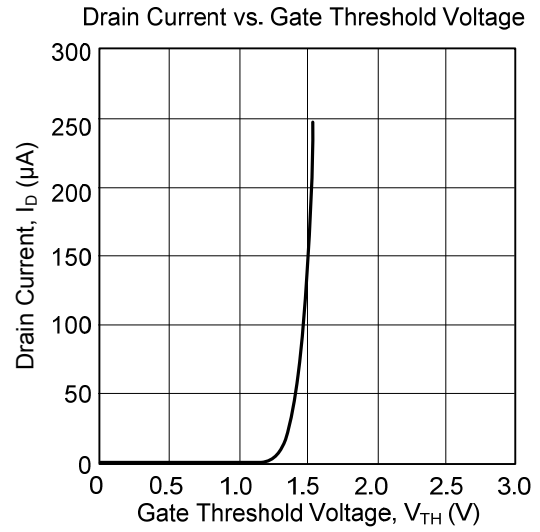
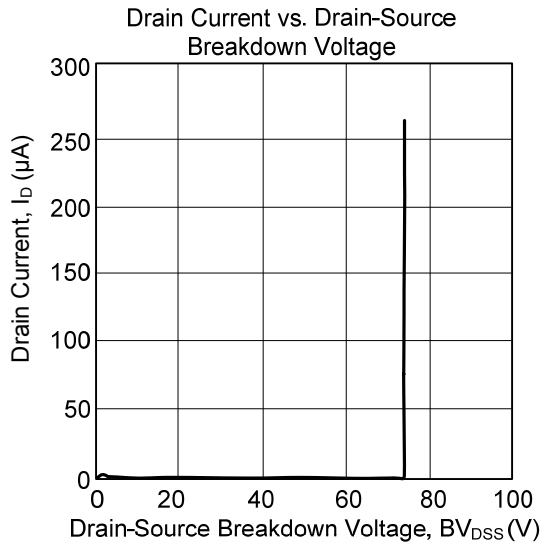

UTC assumes no responsibility for equipment failures that result from using products at values that exceed, even momentarily, rated values (such as maximum ratings, operating condition ranges, or other parameters) listed in products specifications of any and all UTC products described or contained herein. UTC products are not designed for use in life support appliances, devices or systems where malfunction of these products can be reasonably expected to result in personal injury. Reproduction in whole or in part is prohibited without the prior written consent of the copyright owner. The information presented in this document does not form part of any quotation or contract, is believed to be accurate and reliable and may be changed without notice.

单击下面可查看定价，库存，交付和生命周期等信息

[>>UTC\(友顺\)](#)