

Features

- N-Channel, 10V Logic Level Control
- Enhancement mode
- VitoMOS[®] II Technology
- Fast Switching and High efficiency
- 100% Avalanche Tested
- Pb-free lead plating; RoHS compliant

Halogen-Free

Part ID	Package Type	Marking	Packing
VSP003N10HS-G	PDFN5x6	003N10H	3000PCS/Reel

V_{DS}	100	V
$R_{DS(on),TYP}@ V_{GS}=10V$	3.8	m Ω
I_D	125	A

PDFN5x6

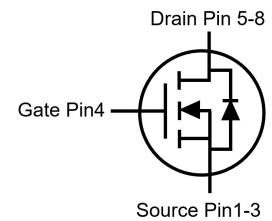
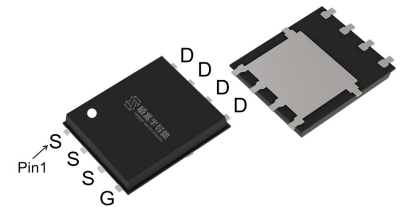

Maximum ratings, at $T_A = 25^\circ\text{C}$, unless otherwise specified

Symbol	Parameter	Rating	Unit
$V_{(BR)DSS}$	Drain-Source breakdown voltage	100	V
V_{GS}	Gate-Source voltage	± 20	V
I_S	Diode continuous forward current	$T_C = 25^\circ\text{C}$	125 A
I_D	Continuous drain current @ $V_{GS}=10V$	$T_C = 25^\circ\text{C}$	125 A
		$T_C = 100^\circ\text{C}$	79 A
I_{DM}	Pulse drain current tested ①	$T_C = 25^\circ\text{C}$	500 A
I_{DSM}	Continuous drain current @ $V_{GS}=10V$	$T_A = 25^\circ\text{C}$	24 A
		$T_A = 70^\circ\text{C}$	19 A
EAS	Avalanche energy, single pulsed ②	144	mJ
P_D	Maximum power dissipation	$T_C = 25^\circ\text{C}$	114 W
P_{DSM}	Maximum power dissipation ③	$T_A = 25^\circ\text{C}$	4.2 W
T_{STG}, T_J	Storage and Junction Temperature Range	-55 to 150	$^\circ\text{C}$

Thermal Characteristics

Symbol	Parameter	Typical	Max	Unit
$R_{\theta JC}$	Thermal Resistance, Junction-to-Case	1.1	1.3	$^\circ\text{C/W}$
$R_{\theta JA}$	Thermal Resistance, Junction-to-Ambient	30	36	$^\circ\text{C/W}$

Electrical Characteristics

Symbol	Parameter	Condition	Min.	Typ.	Max.	Unit
Static Electrical Characteristics @ T_j=25°C (unless otherwise stated)						
V _{(BR)DSS}	Drain-Source Breakdown Voltage	V _{GS} =0V, I _D =250μA	100	--	--	V
I _{DSS}	Zero Gate Voltage Drain Current	V _{DS} =100V, V _{GS} =0V	--	--	1	μA
	Zero Gate Voltage Drain Current(T _j =125°C)	V _{DS} =100V, V _{GS} =0V	--	--	100	μA
I _{GSS}	Gate-Body Leakage Current	V _{GS} =±20V, V _{DS} =0V	--	--	±100	nA
V _{GS(TH)}	Gate Threshold Voltage	V _{DS} =V _{GS} , I _D =250μA	2.3	3.3	3.9	V
R _{DS(ON)}	Drain-Source On-State Resistance④	V _{GS} =10V, I _D =40A	--	3.8	4.8	mΩ
		T _j =100°C	--	5	--	mΩ
Dynamic Electrical Characteristics @ T_j = 25°C (unless otherwise stated)						
C _{iss}	Input Capacitance	V _{DS} =30V, V _{GS} =0V, f=1MHz	3100	3645	4190	pF
C _{oss}	Output Capacitance		1650	1940	2230	pF
C _{rss}	Reverse Transfer Capacitance		25	35	45	pF
R _g	Gate Resistance	f=1MHz	0.5	1.1	1.7	Ω
Q _g	Total Gate Charge	V _{DS} =50V, I _D =40A, V _{GS} =10V	--	47	62	nC
Q _{gs}	Gate-Source Charge		--	18	24	nC
Q _{gd}	Gate-Drain Charge		--	8.5	13	nC
Switching Characteristics						
t _{d(on)}	Turn-on Delay Time	V _{DD} =50V, I _D =40A, R _G =3Ω, V _{GS} =10V	--	15	--	ns
t _r	Turn-on Rise Time		--	39	--	ns
t _{d(off)}	Turn-Off Delay Time		--	27	--	ns
t _f	Turn-Off Fall Time		--	13	--	ns
Source- Drain Diode Characteristics@ T_j = 25°C (unless otherwise stated)						
V _{SD}	Forward on voltage	I _{SD} =40A, V _{GS} =0V	--	0.8	1.2	V
t _{rr}	Reverse Recovery Time	T _j =25°C, I _{SD} =40A, V _{GS} =0V	--	79	158	ns
Q _{rr}	Reverse Recovery Charge	di/dt=100A/μs	--	118	236	nC

NOTE: ① Repetitive rating; pulse width limited by max junction temperature.

② Limited by T_{Jmax}, starting T_J = 25°C, L = 0.5mH, R_G = 25Ω, I_{AS} = 24A, V_{GS} = 10V. Part not recommended for use above this value

③ The power dissipation P_{DSM} is based on R_{θJA} and the maximum allowed junction temperature of 150°C.

④ Pulse width ≤ 380μs; duty cycle ≤ 2%.

Typical Characteristics

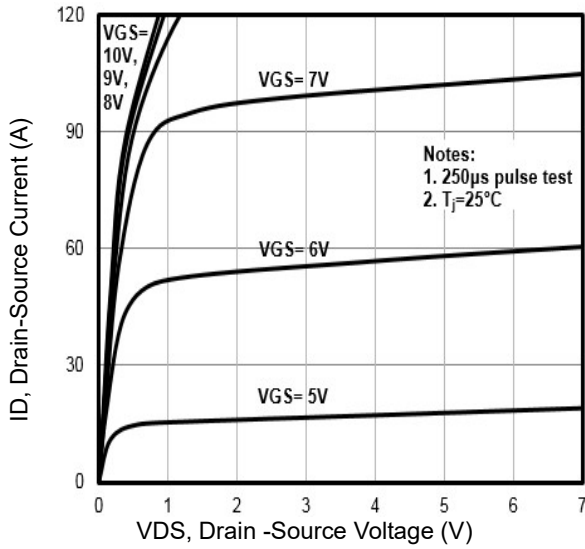

Fig1. Typical Output Characteristics

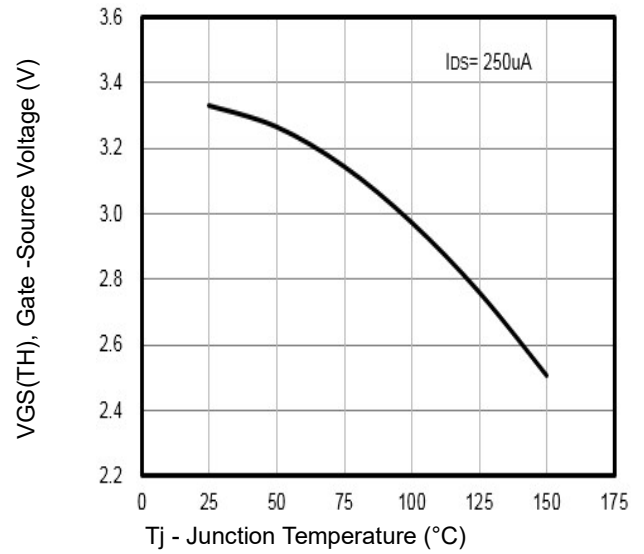

Fig2. $V_{GS(TH)}$ Gate-Source Voltage Vs. T_j

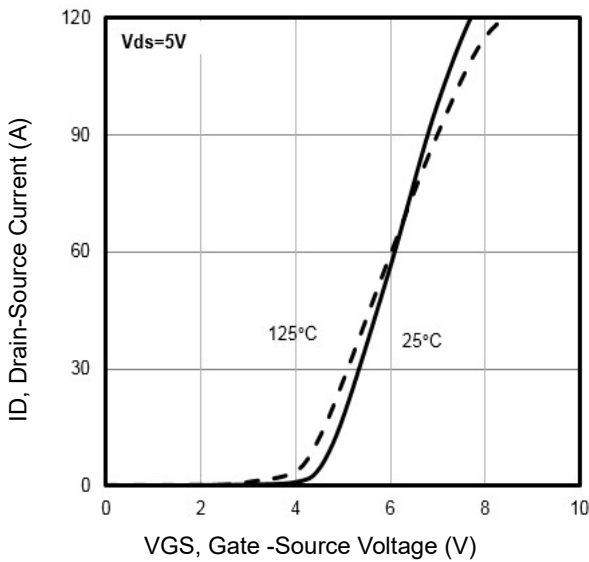

Fig3. Typical Transfer Characteristics

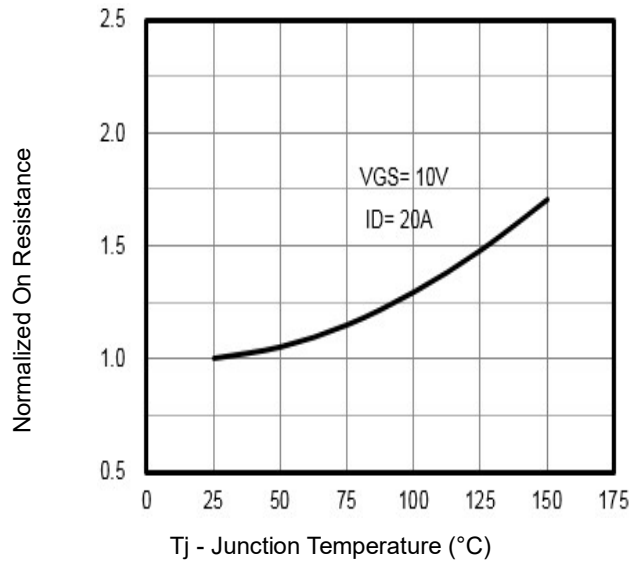

Fig4. Normalized On-Resistance Vs. T_j

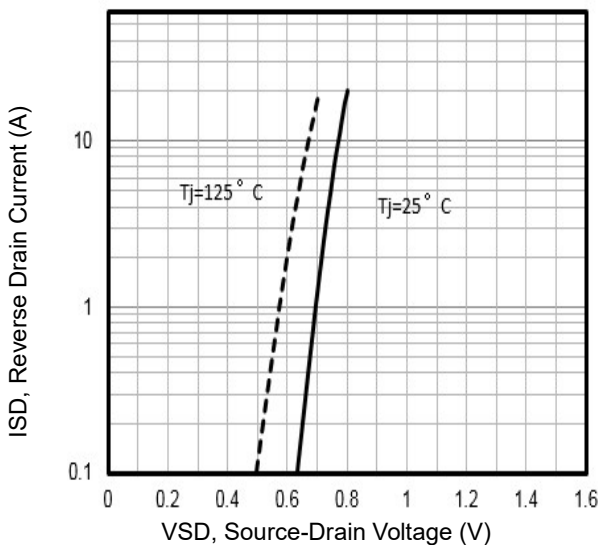

Fig5. Typical Source-Drain Diode Forward Voltage

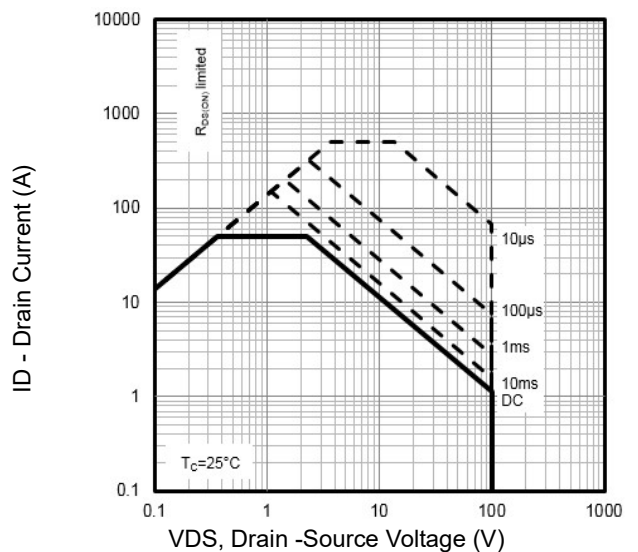

Fig6. Maximum Safe Operating Area

Typical Characteristics

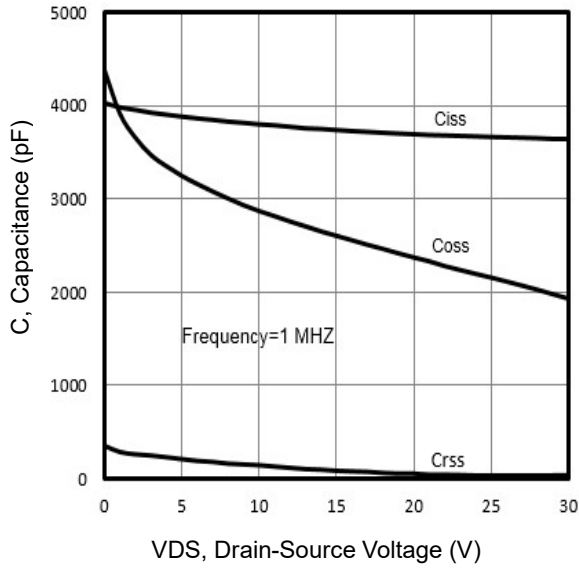

Fig7. Typical Capacitance Vs. Drain-Source Voltage

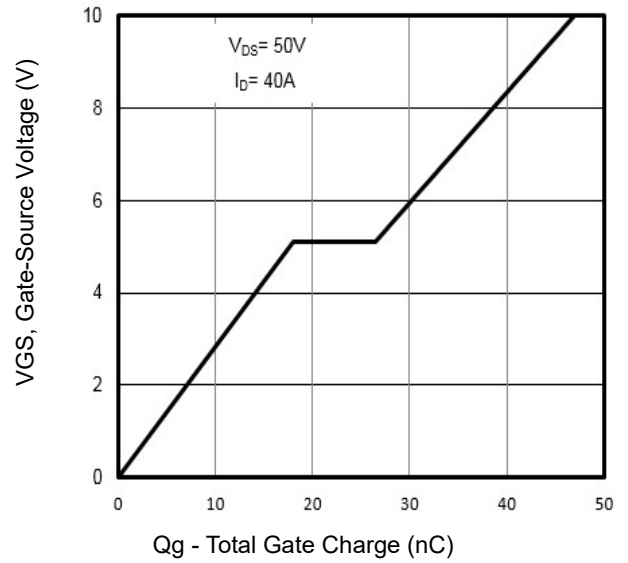

Fig8. Typical Gate Charge Vs. Gate-Source Voltage

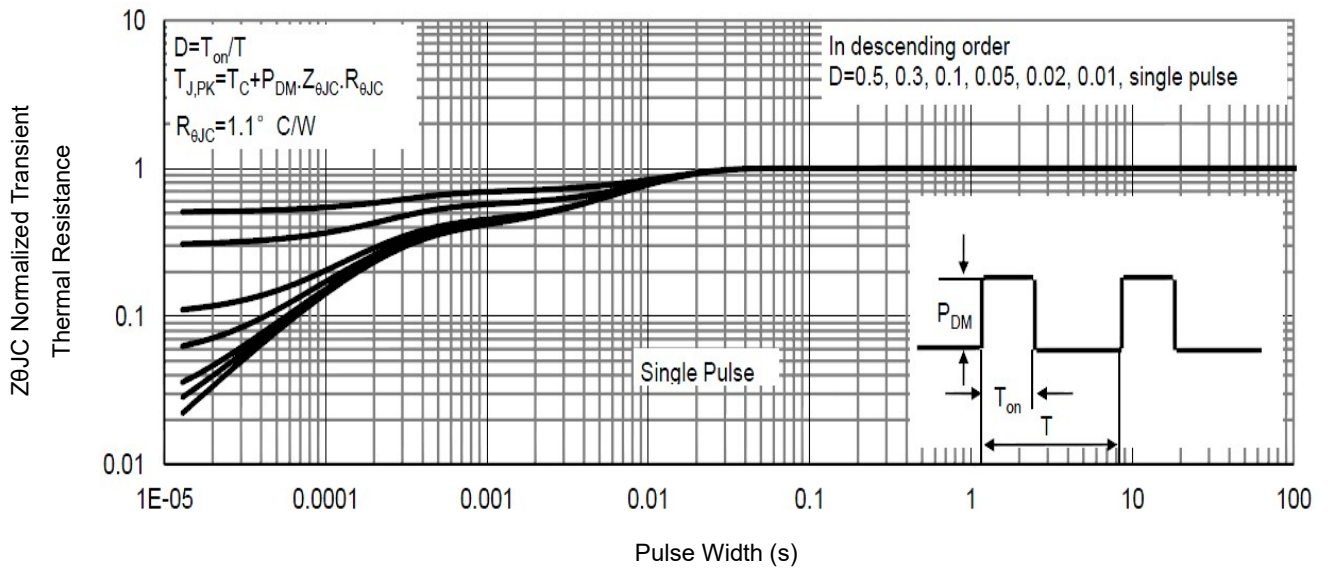

Fig9. Normalized Maximum Transient Thermal Impedance

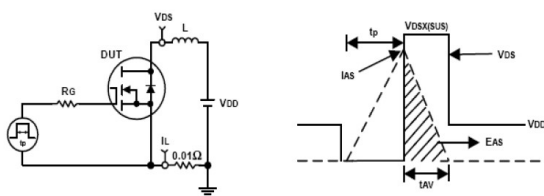

Fig10. Unclamped Inductive Test Circuit and waveforms

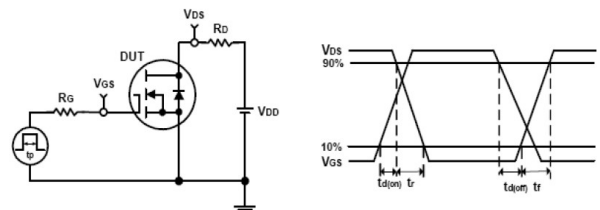
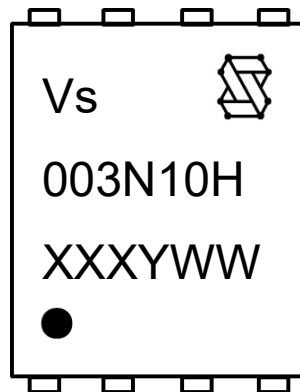

Fig11. Switching Time Test Circuit and waveforms

Marking Information

1st line: Vergiga Code (Vs), Vergiga Logo

2nd line: Part Number (003N10H)

3rd line: Date code (XXXYWW)

XXX: Wafer Lot Number Code, code changed with Lot Number

Y: Year Code, refer to table below

WW: Week Code (01 to 53)

Code	C	D	E	F	G	H	J	K	L	M	N	P	Q	R	S	T
Year	2015	2016	2017	2018	2019	2020	2021	2022	2023	2024	2025	2026	2027	2028	2029	2030

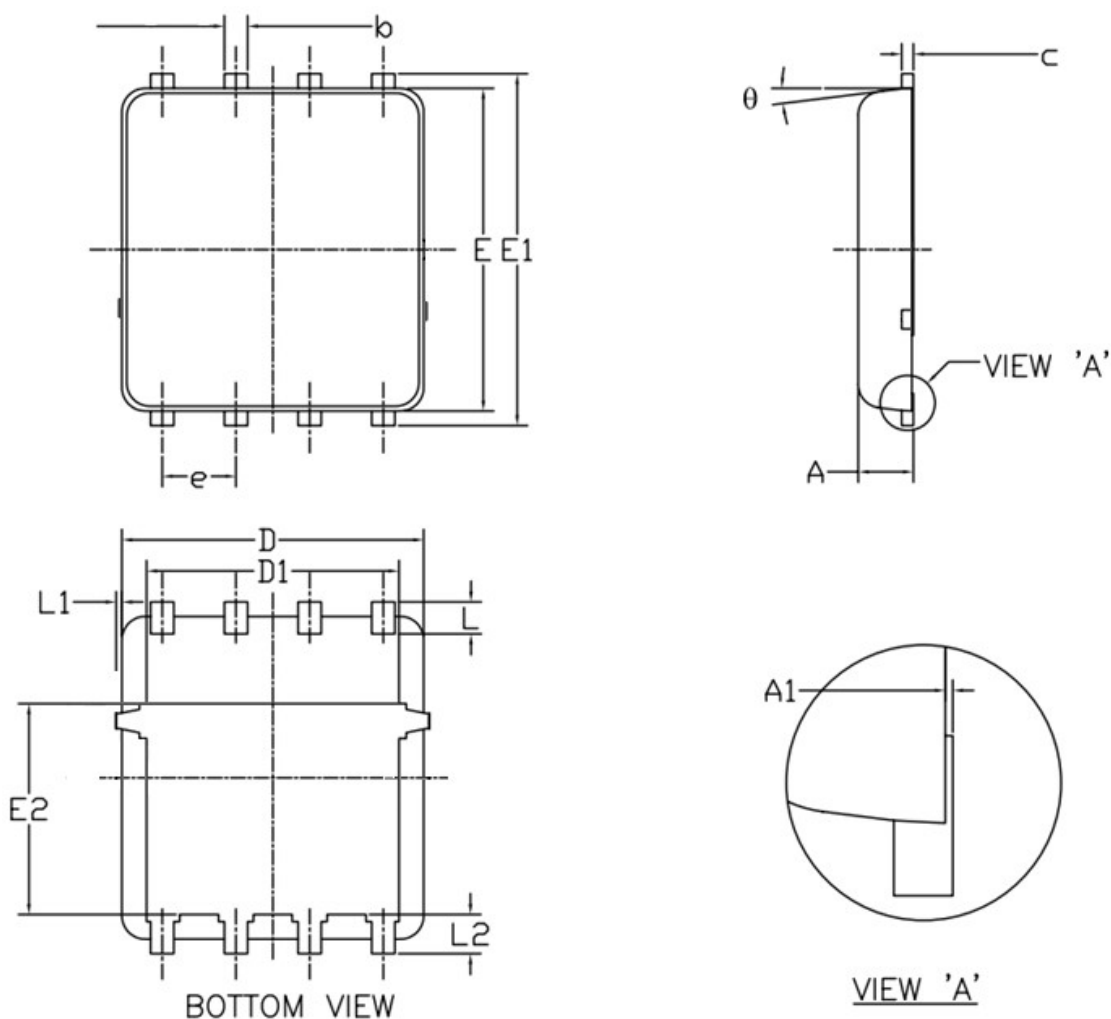
PDFN5x6 Package Outline Data

Symbol	DIMENSIONS (unit : mm)		
	Min	Typ	Max
A	0.90	1.00	1.20
A1	0.00	--	0.05
b	0.30	0.40	0.51
c	0.20	0.25	0.33
D	4.80	4.90	5.40
D1	3.61	4.00	4.25
E	5.65	5.80	6.06
E1	5.90	6.10	6.35
E2	3.38	3.58	3.92
e	1.27 BSC		
L	0.51	0.61	0.71
L1	--	--	0.15
L2	0.41	0.51	0.61
θ	0°	--	12°

Notes:

1. Refer to JEDEC MO-240 variation AA.
2. Dimensions "D" and "E" do NOT include mold flash protrusions or gate burrs.
3. Dimensions "D" and "E" include interterminal flash or protrusion. Interterminal flash or protrusion shall not exceed 0.25mm per side.

Customer Service
Sales and Service:
sales@vgsemi.com
Vergiga Semiconductor CO., LTD
TEL: (86-755)-26902410

FAX: (86-755)-26907027

WEB: www.vgsemi.com

单击下面可查看定价，库存，交付和生命周期等信息

[>>Vanguard Semiconduct\(威兆半导体\)](#)