

Features

- Enhancement mode
- Low on-resistance $R_{DS(on)}$ @ $V_{GS}=4.5\text{ V}$
- Fast Switching and High efficiency
- 100% Avalanche test
- Pb-free lead plating; RoHS compliant



Part ID	Package Type	Marking	Tape and reel information
VS3610AD-A	TO-252	3610AD	2500pcs/Reel

V_{DS}	30	V
$R_{DS(on),TYP}$ @ $V_{GS}=10\text{ V}$	5.1	m Ω
$R_{DS(on),TYP}$ @ $V_{GS}=4.5\text{ V}$	8.5	m Ω
I_D	75	A

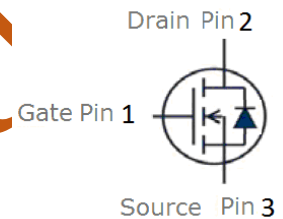

Maximum ratings, at $T_A=25^\circ\text{C}$, unless otherwise specified

Symbol	Parameter	Rating	Unit
$V_{(BR)DSS}$	Drain-Source breakdown voltage	30	V
V_{GS}	Gate-Source voltage	± 20	V
I_S	Diode continuous forward current	$T_C=25^\circ\text{C}$	75 A
I_D	Continuous drain current @ $V_{GS}=10\text{V}$	$T_C=25^\circ\text{C}$	75 A
		$T_C=100^\circ\text{C}$	53 A
I_{DM}	Pulse drain current tested ①	$T_C=25^\circ\text{C}$	300 A
I_{DSM}	Continuous drain current @ $V_{GS}=10\text{V}$	$T_A=25^\circ\text{C}$	12 A
		$T_A=70^\circ\text{C}$	9 A
EAS	Avalanche energy, single pulsed ②	42	mJ
P_D	Maximum power dissipation	$T_C=25^\circ\text{C}$	52 W
		$T_C=100^\circ\text{C}$	26 W
P_{DSM}	Maximum power dissipation ③	$T_A=25^\circ\text{C}$	1.25 W
		$T_A=70^\circ\text{C}$	0.8 W
T_{STG}, T_J	Storage and Junction Temperature Range	-55 to 175	$^\circ\text{C}$

Thermal Characteristics

Symbol	Parameter	Typical	Unit
$R_{\theta JC}$	Thermal Resistance, Junction-to-Case	2.9	$^\circ\text{C/W}$
$R_{\theta JA}$	Thermal Resistance, Junction-to-Ambient	100	$^\circ\text{C/W}$

Electrical Characteristics

Symbol	Parameter	Condition	Min.	Typ.	Max.	Unit
Static Electrical Characteristics @ T_j=25°C (unless otherwise stated)						
V _{(BR)DSS}	Drain-Source Breakdown Voltage	V _{GS} =0V, I _D =250μA	30	--	--	V
I _{DSS}	Zero Gate Voltage Drain Current	V _{DS} =30V, V _{GS} =0V	--	--	1	μA
	Zero Gate Voltage Drain Current (T _j =125°C)	V _{DS} =30V, V _{GS} =0V	--	--	100	μA
I _{GSS}	Gate-Body Leakage Current	V _{GS} =±20V, V _{DS} =0V	--	--	±100	nA
V _{GS(TH)}	Gate Threshold Voltage	V _{DS} =V _{GS} , I _D =250μA	1.3	1.7	2.5	V
R _{DS(ON)}	Drain-Source On-State Resistance ④	V _{GS} =10V, I _D =20A	--	5.1	7.2	mΩ
		T _j =100°C	--	6.2	--	mΩ
R _{DS(ON)}	Drain-Source On-State Resistance ④	V _{GS} =4.5V, I _D =16A	--	8.5	12	mΩ
Dynamic Electrical Characteristics @ T_j = 25°C (unless otherwise stated)						
C _{iss}	Input Capacitance	V _{DS} =15V, V _{GS} =0V, f=1MHz	1930	2270	2610	pF
C _{oss}	Output Capacitance		205	240	275	pF
C _{rss}	Reverse Transfer Capacitance		185	220	255	pF
R _g	Gate Resistance		f=1MHz	--	1.6	--
Q _g (10V)	Total Gate Charge	V _{DS} =15V, I _D =20A, V _{GS} =10V	--	48	--	nC
Q _g (4.5V)	Total Gate Charge		--	24	--	nC
Q _{gs}	Gate-Source Charge		--	7.2	--	nC
Q _{gd}	Gate-Drain Charge		--	10	--	nC
Switching Characteristics						
t _{d(on)}	Turn-on Delay Time	V _{DD} =15V, I _D =20A, R _G =3Ω, V _{GS} =10V	--	9	--	ns
t _r	Turn-on Rise Time		--	57	--	ns
t _{d(off)}	Turn-Off Delay Time		--	37	--	ns
t _f	Turn-Off Fall Time		--	25	--	ns
Source- Drain Diode Characteristics @ T_j = 25°C (unless otherwise stated)						
V _{SD}	Forward on voltage	I _{SD} =20A, V _{GS} =0V	--	0.8	1.2	V
t _{rr}	Reverse Recovery Time	T _j =25°C, I _{sd} =20A, V _{GS} =0V	--	11	--	ns
Q _{rr}	Reverse Recovery Charge	di/dt=100A/μs	--	3.2	--	nC

NOTE: ① Repetitive rating; pulse width limited by max junction temperature.

② Limited by T_{Jmax}, starting T_J = 25°C, L = 0.5mH, R_G = 25Ω, I_{AS} = 13A, V_{GS} = 10V. Part not recommended for use above this value

③ The power dissipation P_{DSM} is based on R_{θJA} and the maximum allowed junction temperature of 150°C.

④ Pulse width ≤ 380μs; duty cycle ≤ 2%.

Typical Characteristics

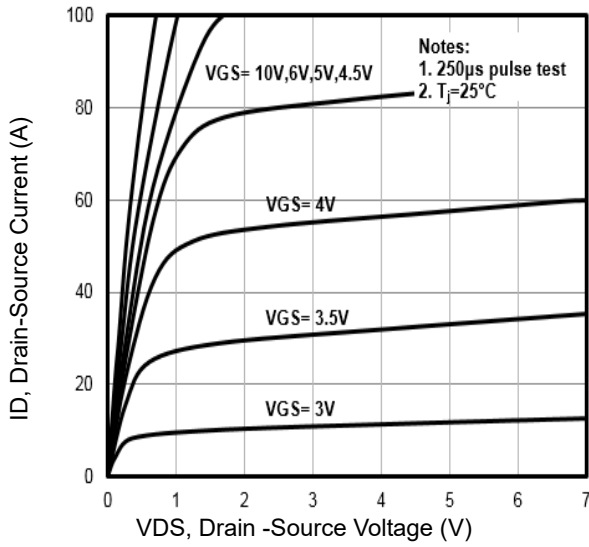

Fig1. Typical Output Characteristics

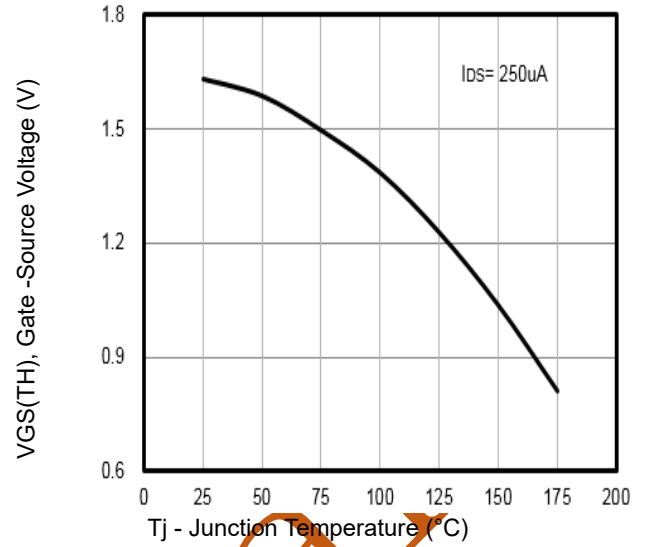

Fig2. $V_{GS(TH)}$ Gate-Source Voltage Vs. T_j

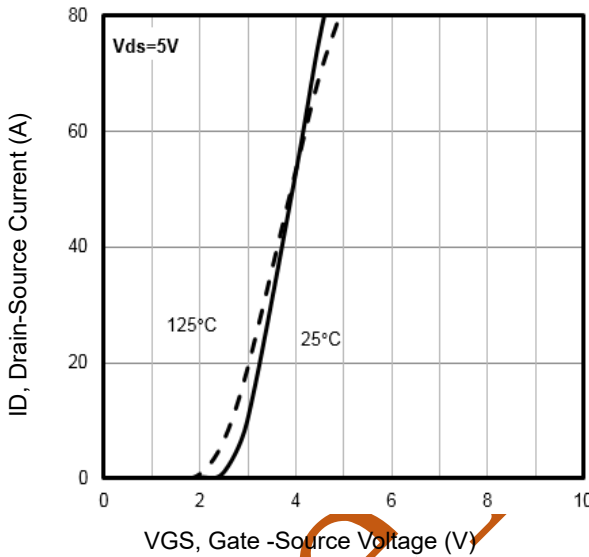

Fig3. Typical Transfer Characteristics

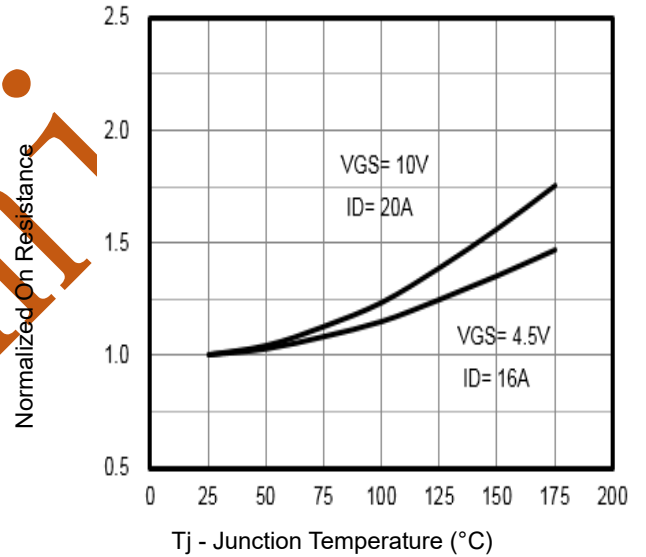

Fig4. Normalized On-Resistance Vs. T_j

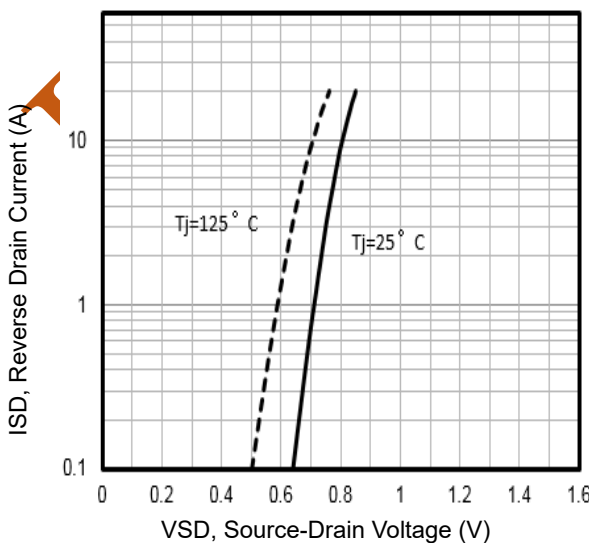

Fig5. Typical Source-Drain Diode Forward Voltage

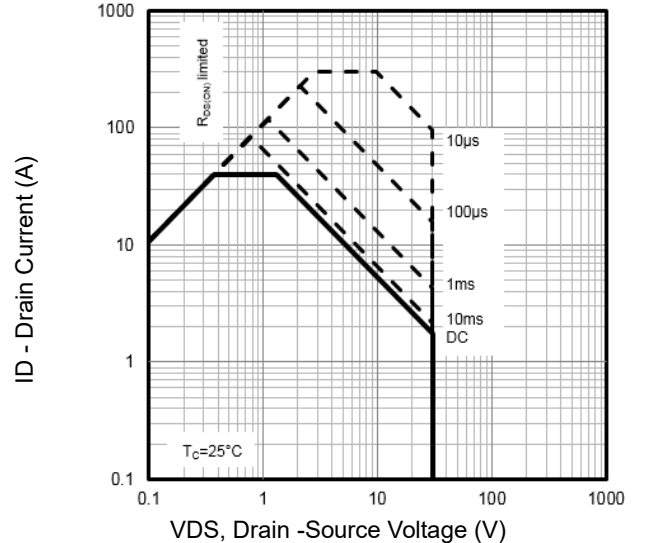

Fig6. Maximum Safe Operating Area

Typical Characteristics

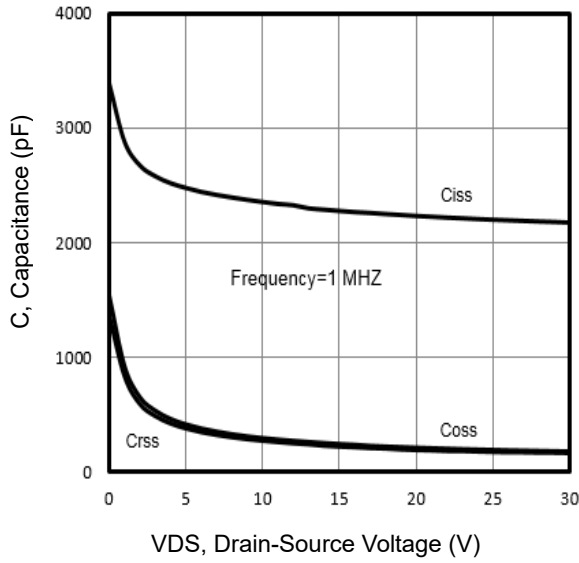

Fig7. Typical Capacitance Vs. Drain-Source Voltage

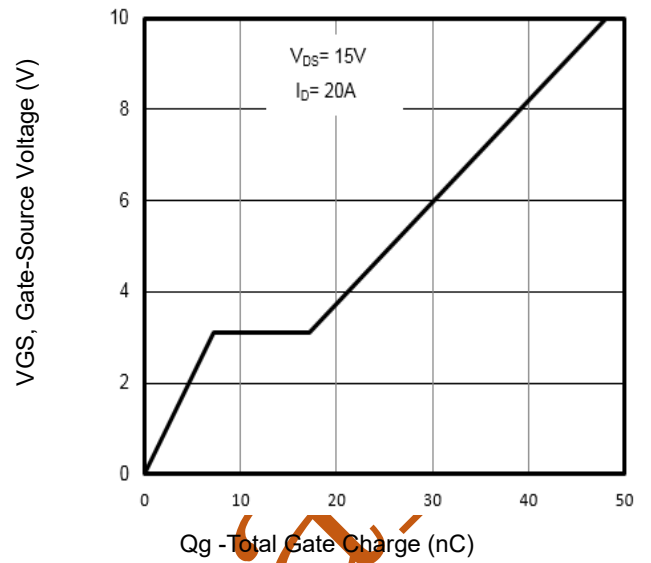

Fig8. Typical Gate Charge Vs. Gate-Source Voltage

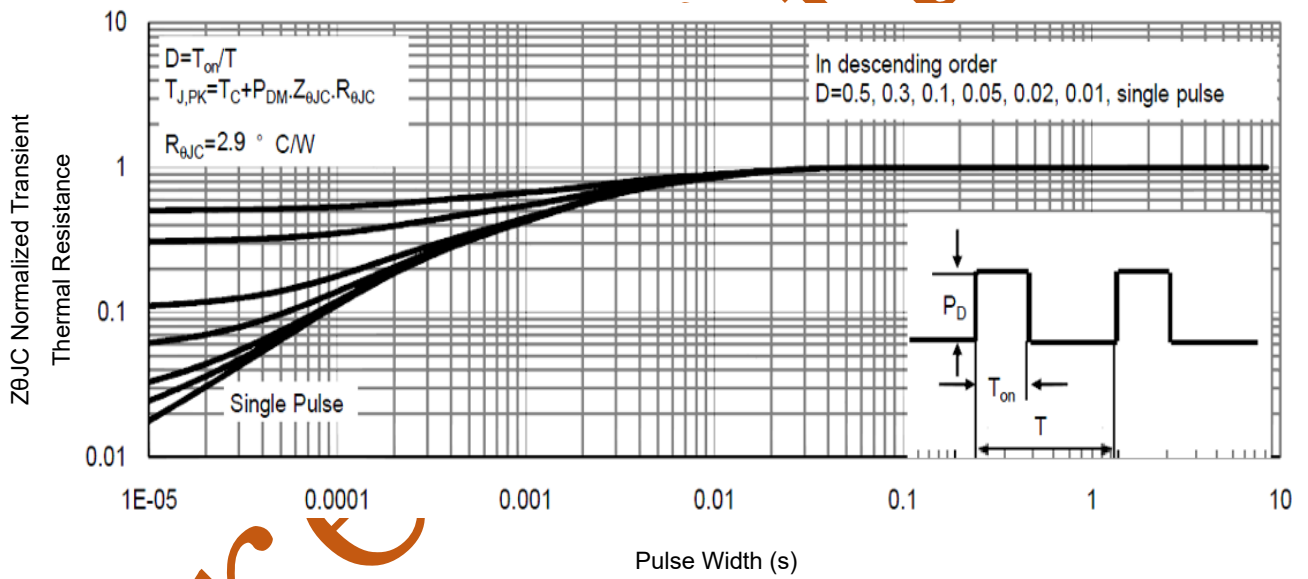

Fig9. Normalized Maximum Transient Thermal Impedance

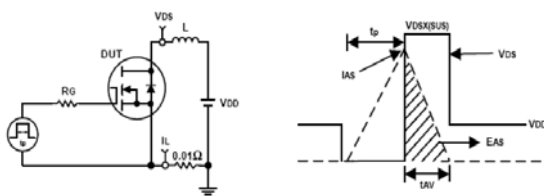

Fig10. Unclamped Inductive Test Circuit and waveforms

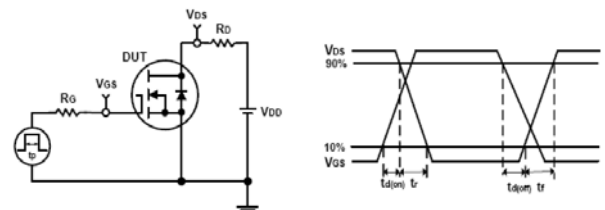
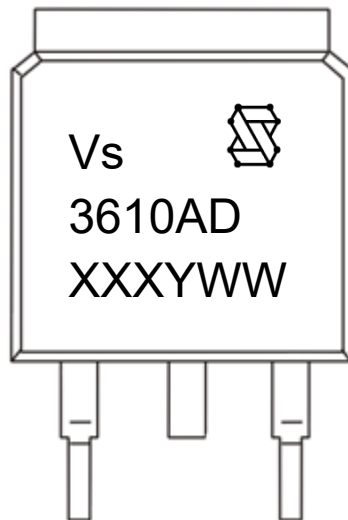

Fig11. Switching Time Test Circuit and waveforms

Marking Information



- 1st line: Vanguard Code (Vs), Vanguard Logo
2nd line: Part Number (3610AD)
3rd line: Date code (XXXYWW)
XXX: Wafer Lot Number Code , code changed with Lot Number
Y: Year Code, (e.g. E=2017, F=2018, G=2019, H=2020, etc)
WW: Week Code (01 to 53)

Preliminary

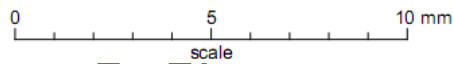
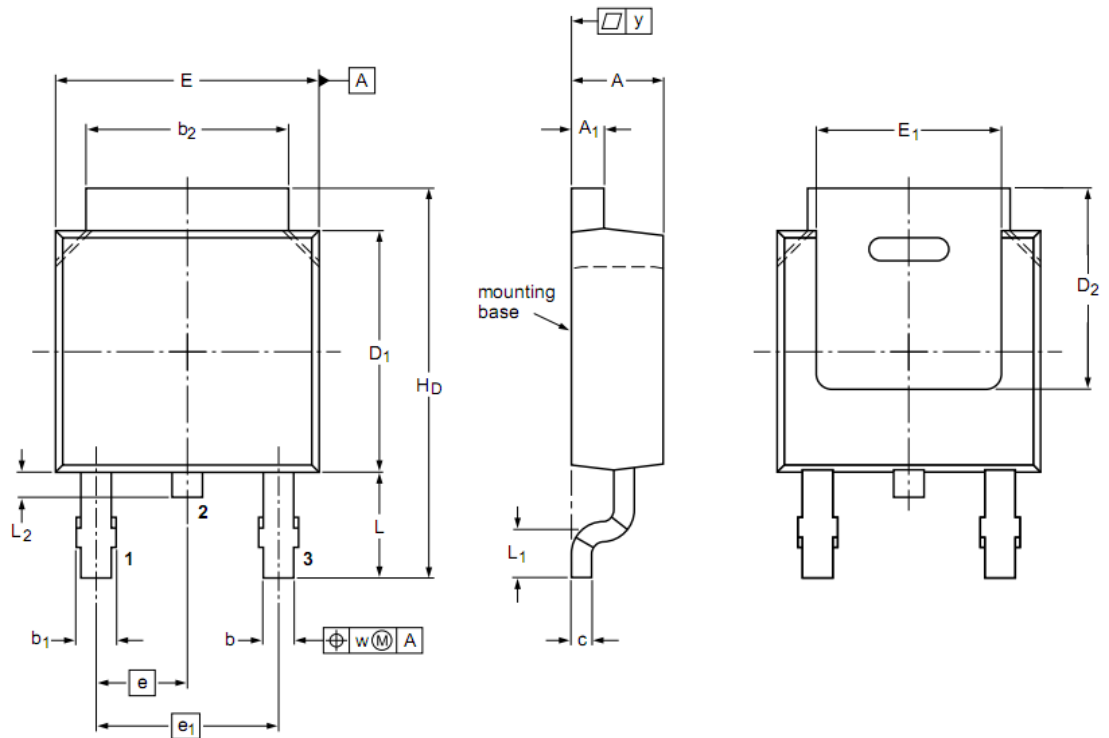
TO-252 Package Outline Data

Symbol	Dimensions (unit: mm)		
	Min	Typ	Max
A	2.20	2.30	2.38
A₁	0.46	0.50	0.63
b	0.64	0.76	0.89
b₁	0.77	0.85	1.14
b₂	5.00	5.33	5.46
c	0.458	0.508	0.558
D₁	5.98	6.10	6.223
D₂	5.21	--	--
E	6.40	6.60	6.731
E₁	4.40	--	--
e	2.286 BSC		
e₁	--	4.57	--
H_D	9.40	10.00	10.40
L	2.743 REF		
L₁	1.40	1.52	1.77
L₂	0.50	0.80	1.01
w	--	0.20	--
y	--	--	0.20

Notes:

1. Refer to JEDEC TO-252 variation AA
2. Dimension "E" does NOT include mold flash, protrusions or gate burrs. Mold flash, protrusions or gate burrs shall not exceed 0.1524mm per side.
3. Dimension "D1" does NOT include interlead flash or protrusion. Interlead flash or protrusion shall not exceed 0.1524mm per end.

Customer Service
Sales and Service:
sales@vgsemi.com
Vanguard Semiconductor CO., LTD
TEL: (86-755) -26902410

FAX: (86-755) -26907027

WEB: www.vgsemi.com

单击下面可查看定价，库存，交付和生命周期等信息

[>>Vanguard Semiconduct\(威兆半导体\)](#)