

Features

- Dual N-Channel, 5V Logic Level Control
- Enhancement mode
- Fast Switching
- High Effective
- Pb-free lead plating; RoHS compliant; Halogen-Free

| | | |
|-------------------------------|----|------------|
| V_{DS} | 30 | V |
| $R_{DS(on),TYP@ V_{GS}=10V}$ | 16 | m Ω |
| $R_{DS(on),TYP@ V_{GS}=4.5V}$ | 24 | m Ω |
| I_D | 9 | A |



| Part ID | Package Type | Marking | Tape and reel information |
|----------|--------------|---------|---------------------------|
| VS3640DS | SOP8 | 3640DS | 3000pcs/reel |

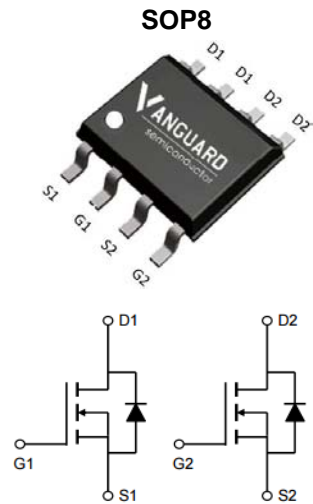

Maximum ratings, at $T_j=25^\circ\text{C}$, unless otherwise specified

| Symbol | Parameter | Rating | Unit |
|---------------|---|--------------------------------|------------------|
| $V_{(BR)DSS}$ | Drain-Source breakdown voltage | 30 | V |
| I_S | Diode continuous forward current | $T_A=25^\circ\text{C}$ 2.3 | A |
| I_D | Continuous drain current @ $V_{GS}=10V$ | $T_A=25^\circ\text{C}$ 9 | A |
| | | $T_A=100^\circ\text{C}$ 5.7 | A |
| I_{DM} | Pulse drain current tested ① | $T_A=25^\circ\text{C}$ 36 | A |
| EAS | Avalanche energy, single pulsed ② | 9 | mJ |
| P_D | Maximum power dissipation | $T_A=25^\circ\text{C}$ 2 | W |
| V_{GS} | Gate-Source voltage | ± 20 | V |
| MSL | | Level 3 | |
| T_{STG} | Storage temperature range | -55 to 150 | $^\circ\text{C}$ |

Thermal Characteristics

| Symbol | Parameter | Typical | Unit |
|-----------------|--|---------|--------------------|
| $R_{\theta JL}$ | Thermal Resistance-Junction to Lead | 40 | $^\circ\text{C/W}$ |
| $R_{\theta JA}$ | Thermal Resistance-Junction to Ambient | 62.5 | $^\circ\text{C/W}$ |



Typical Electrical Characteristics

| Symbol | Parameter | Condition | Min. | Typ. | Max. | Unit |
|---|---|---|------|------|------|------|
| Static Electrical Characteristics @ T_J = 25°C (unless otherwise stated) | | | | | | |
| V _{(BR)DSS} | Drain-Source Breakdown Voltage | V _{GS} =0V, I _D =250μA | 30 | -- | -- | V |
| I _{DSS} | Zero Gate Voltage Drain Current(Tc=25°C) | V _{DS} =30V, V _{GS} =0V | -- | -- | 1 | μA |
| | Zero Gate Voltage Drain Current(Tc=125°C) | V _{DS} =30V, V _{GS} =0V | -- | -- | 100 | μA |
| I _{GSS} | Gate-Body Leakage Current | V _{GS} =±20V, V _{DS} =0V | -- | -- | ±100 | nA |
| V _{GS(TH)} | Gate Threshold Voltage | V _{DS} =V _{GS} , I _D =250μA | 1 | 1.9 | 2.5 | V |
| R _{DS(ON)} | Drain-Source On-State Resistance ② | V _{GS} =10V, I _D =8A | -- | 16 | 19 | mΩ |
| R _{DS(ON)} | Drain-Source On-State Resistance ② | V _{GS} =4.5V, I _D =4A | -- | 24 | 29 | mΩ |
| Dynamic Electrical Characteristics @ T_J = 25°C (unless otherwise stated) | | | | | | |
| C _{iss} | Input Capacitance | V _{DS} =15V, V _{GS} =0V, f=1MHz | -- | 455 | -- | pF |
| C _{oss} | Output Capacitance | | -- | 75 | -- | pF |
| C _{rss} | Reverse Transfer Capacitance | | -- | 60 | -- | pF |
| R _g | Gate Resistance | f=1MHz | -- | 3.3 | -- | Ω |
| Q _g | Total Gate Charge | V _{DS} =15V, I _D =8A, V _{GS} =10V | -- | 11 | -- | nC |
| Q _{gs} | Gate-Source Charge | | -- | 3 | -- | nC |
| Q _{gd} | Gate-Drain Charge | | -- | 4 | -- | nC |
| Switching Characteristics | | | | | | |
| t _{d(on)} | Turn-on Delay Time | V _{DD} =15V, I _D =8A, R _G =3Ω, V _{GS} =10V | -- | 7 | -- | nS |
| t _r | Turn-on Rise Time | | -- | 10 | -- | nS |
| t _{d(off)} | Turn-Off Delay Time | | -- | 22 | -- | nS |
| t _f | Turn-Off Fall Time | | -- | 7 | -- | nS |
| Source- Drain Diode Characteristics @ T_J = 25°C (unless otherwise stated) | | | | | | |
| V _{SD} | Forward on voltage | I _{SD} =8A, V _{GS} =0V | -- | 0.9 | 1.2 | V |
| t _{rr} | Reverse Recovery Time | T _J =25°C, I _{sd} =8A, V _{GS} =0V di/dt=500A/μs | -- | 9.5 | -- | nS |
| Q _{rr} | Reverse Recovery Charge | | -- | 11.8 | -- | nC |

NOTE:

- ① Repetitive rating; pulse width limited by max. junction temperature.
- ② Limited by T_{Jmax}, starting T_J = 25°C, L = 0.5mH, R_G = 25Ω, I_{AS} = 6A, V_{GS} = 10V. Part not recommended for use above this value
- ③ Pulse width ≤ 300μs; duty cycles ≤ 2%.

Typical Characteristics

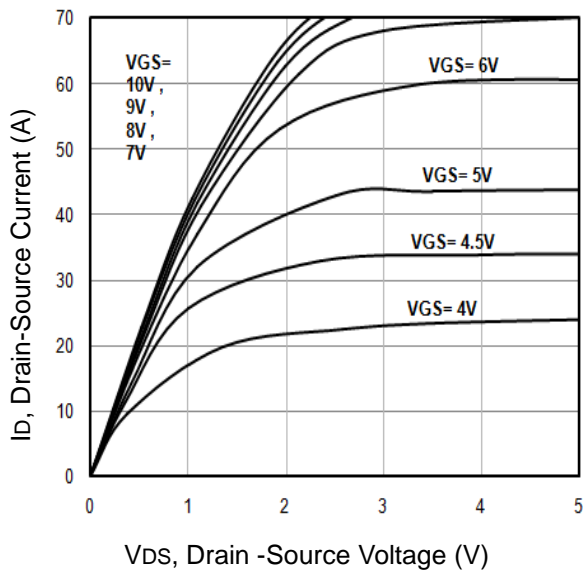

Fig1. Typical Output Characteristics

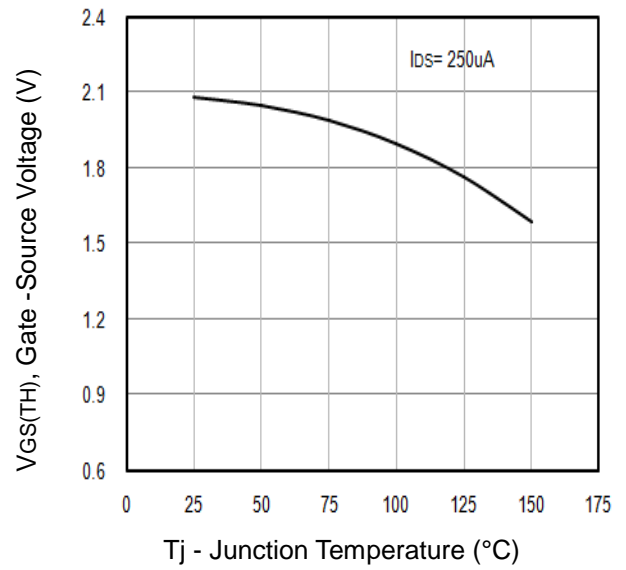

Fig2. Threshold Voltage Vs. Temperature

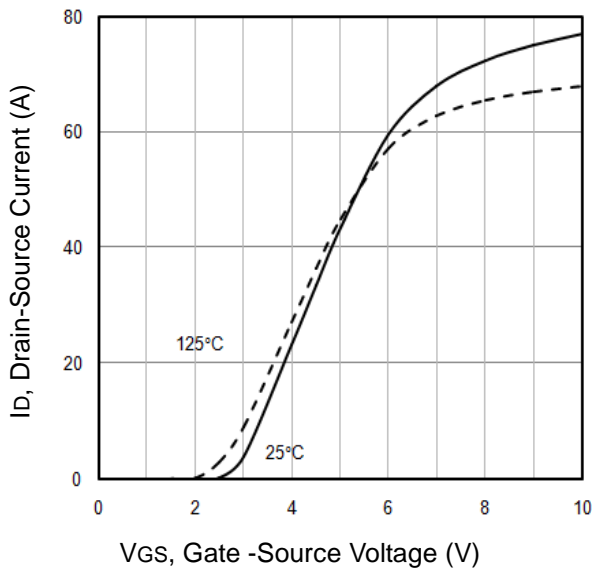

Fig3. Typical Transfer Characteristics

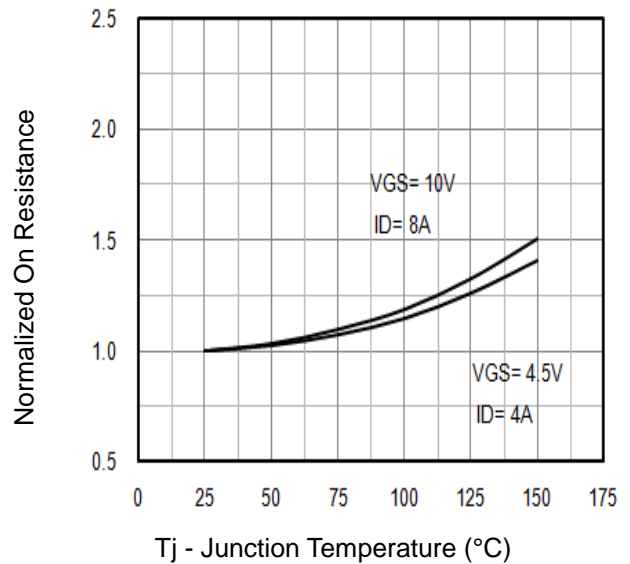

Fig4. Normalized On-Resistance Vs. Temperature

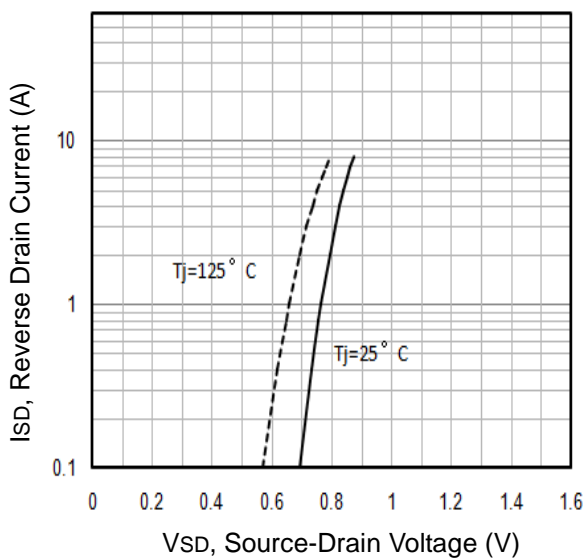

Fig5. Typical Source-Drain Diode Forward Voltage

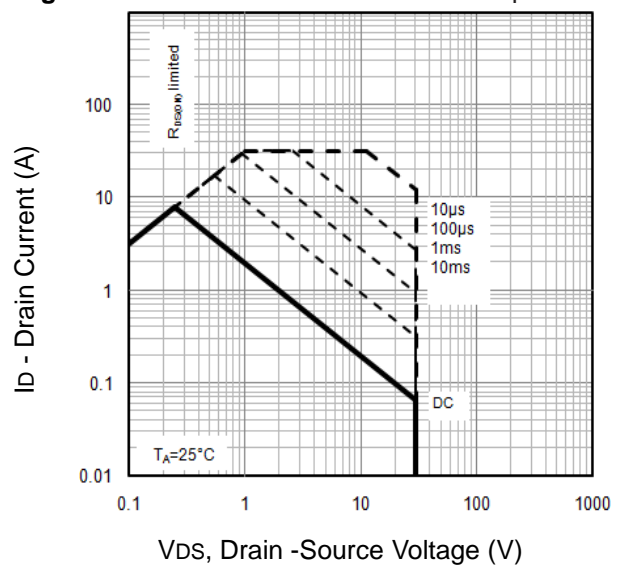

Fig6. Maximum Safe Operating Area

Typical Characteristics

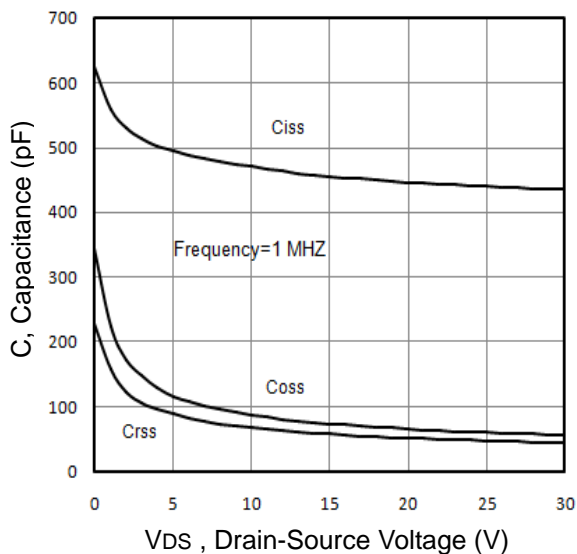

Fig7. Typical Capacitance Vs.Drain-Source Voltage

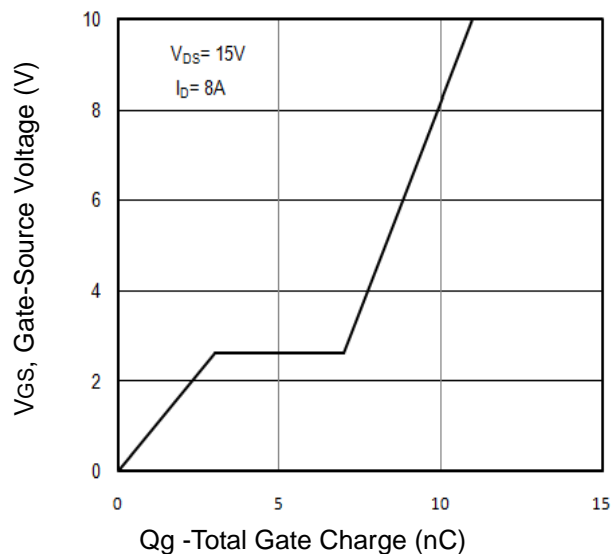

Fig8. Typical Gate Charge Vs.Gate-Source Voltage

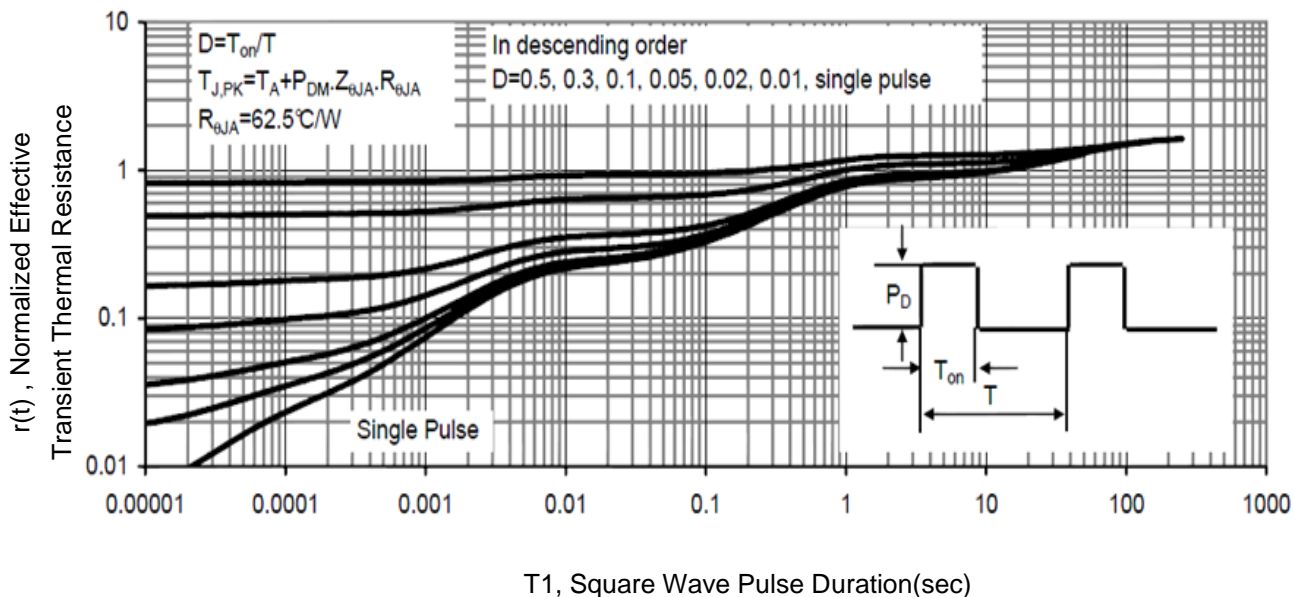

Fig9. T1, Transient Thermal Response Curve

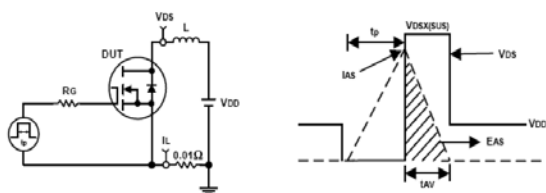

Fig10. Unclamped Inductive Test Circuit and waveforms

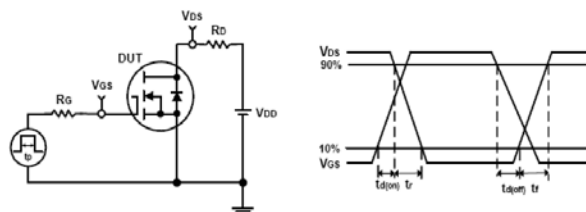
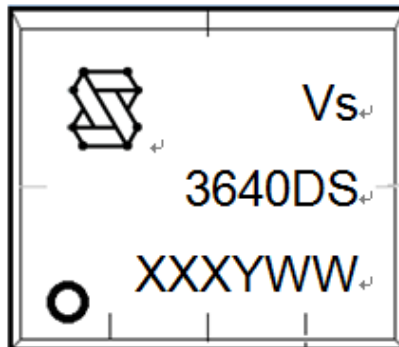

Fig11. Switching Time Test Circuit and waveforms

Marking Information



1st line: Company Code (Vs), Company Logo

2nd line: Part Number (3640DS)

3rd line: Date code (XXXYWW)

LOT: Wafer Lot Number

Y: Year Code, e.g. E means 2017

WW: Week Code

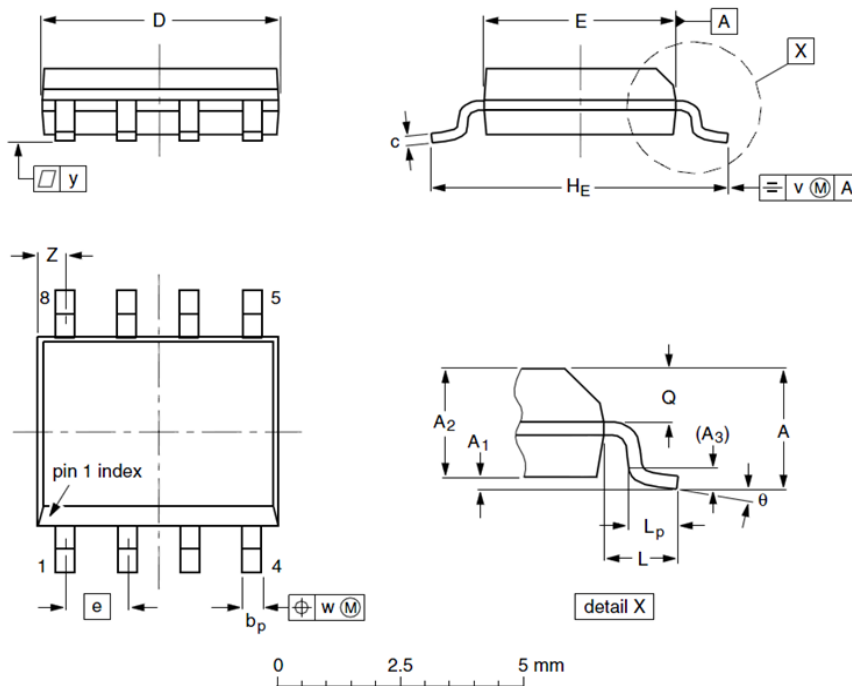
SOP8 Package Outline Data

| Label | Dimensions (unit: mm) | | |
|----------------|-----------------------|------|-------|
| | Min | Typ | Max |
| A | -- | -- | 1.75 |
| A ₁ | 0.10 | 0.18 | 0.25 |
| A ₂ | 1.25 | 1.35 | 1.50 |
| A ₃ | -- | 0.25 | -- |
| b _p | 0.36 | 0.42 | 0.51 |
| c | 0.19 | 0.22 | 0.25 |
| D | 4.80 | 4.92 | 5.00 |
| E | 3.80 | 3.90 | 4.00 |
| e | -- | 1.27 | -- |
| H _E | 5.80 | 6.00 | 6.20 |
| L | -- | 1.05 | -- |
| L _p | 0.40 | 0.68 | 1.00 |
| Q | 0.60 | 0.65 | 0.725 |
| v | -- | 0.25 | -- |
| w | -- | 0.25 | -- |
| y | -- | 0.10 | -- |
| Z | 0.30 | 0.50 | 0.70 |
| θ | 0° | | 8° |

Notes:

1. Follow JEDEC MS-012.
2. Dimension "D" does NOT include mold flash, protrusions or gate burrs. Mold flash, protrusions or gate burrs shall not exceed 0.15mm per side.
3. Dimension "E" does NOT include interlead flash or protrusion. Interlead flash or protrusion shall not exceed 0.25mm per side.
4. Dimension "b_p" does NOT include dambar protrusion. Allowable dambar protrusion shall be 0.1mm total in excess of "b_p" dimension at maximum material condition. The dambar cannot be located on the lower radius of the foot.

Customer Service
Sales and Service:
sales@vgsemi.com
Vanguard Semiconductor CO., LTD
TEL: (86-755) -26902410

FAX: (86-755) -26907027

WEB: www.vgsemi.com

单击下面可查看定价，库存，交付和生命周期等信息

[>>Vanguard Semiconduct\(威兆半导体\)](#)