

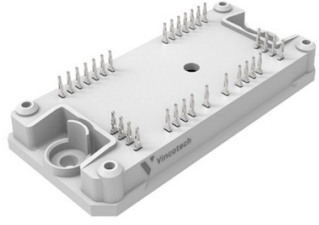
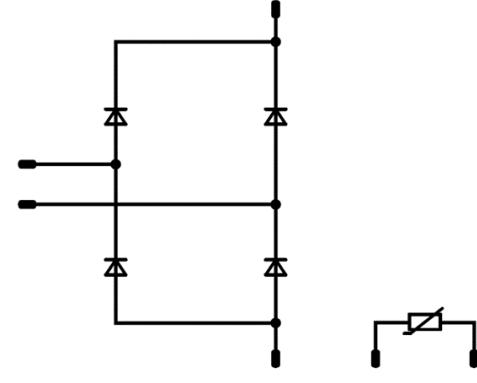

Vincotech

<i>flowCON 1</i>	650 V / 160 A
<div style="border: 1px solid black; padding: 5px; margin-bottom: 5px;"> <p style="text-align: center; background-color: #ccc; margin: 0;">Features</p> <ul style="list-style-type: none"> Single-phase Rectifier High speed diodes Low inductive design Integrated thermistor </div> <div style="border: 1px solid black; padding: 5px; margin-bottom: 5px;"> <p style="text-align: center; background-color: #ccc; margin: 0;">Target applications</p> <ul style="list-style-type: none"> Charging Stations Power Supply </div> <div style="border: 1px solid black; padding: 5px;"> <p style="text-align: center; background-color: #ccc; margin: 0;">Types</p> <ul style="list-style-type: none"> 10-PG07ORA160RF-LJ53I88T </div>	<div style="border: 1px solid black; padding: 5px; margin-bottom: 5px;"> <p style="text-align: center; background-color: #ccc; margin: 0;"><i>flow 1 12mm housing</i></p>  </div> <div style="border: 1px solid black; padding: 5px;"> <p style="text-align: center; background-color: #ccc; margin: 0;">Schematic</p>  </div>

Maximum Ratings

$T_j = 25\text{ °C}$, unless otherwise specified

Parameter	Symbol	Condition	Value	Unit
Rectifier Diode				
Peak repetitive reverse voltage	V_{RRM}		650	V
Continuous (direct) forward current	I_F	$T_j = T_{jmax}$ $T_s = 80\text{ °C}$	117	A
Repetitive peak forward current	I_{FRM}		640	A
Total power dissipation	P_{tot}	$T_j = T_{jmax}$ $T_s = 80\text{ °C}$	165	W
Maximum junction temperature	T_{jmax}		175	°C



Vincotech

Maximum Ratings

$T_j = 25\text{ °C}$, unless otherwise specified

Parameter	Symbol	Condition	Value	Unit
-----------	--------	-----------	-------	------

Module Properties

Thermal Properties

Storage temperature	T_{stg}		-40...+125	°C
Operation temperature under switching condition	T_{top}		-40...(T _{max} - 25)	°C

Isolation Properties

Isolation voltage	V_{isol}	DC Test Voltage* $t_p = 2\text{ s}$	6000	V
		AC Voltage $t_p = 1\text{ min}$	2500	V
Creepage distance			min. 12,7	mm
Clearance			8,38	mm
Comparative Tracking Index	CTI		> 200	

*100 % tested in production



Vincotech

Characteristic Values

Parameter	Symbol	Conditions					Value			Unit
		V_{GE} [V] V_{GS} [V]	V_{CE} [V] V_{DS} [V]	I_C [A] I_D [A]	I_D [A] I_F [A]	T_j [°C]	Min	Typ	Max	

Rectifier Diode

Static

Forward voltage	V_F			160	25 125 150		1,55 1,62 1,62	1,9		V
Reverse leakage current	I_R		650		25			20		μA

Thermal

Thermal resistance junction to sink	$R_{th(j-s)}$	$\lambda_{paste} = 3,4$ W/mK (PSX)					0,58			K/W
-------------------------------------	---------------	---------------------------------------	--	--	--	--	------	--	--	-----

Thermistor

Rated resistance	R				25		22			kΩ
Deviation of R_{100}	$\Delta_{R/R}$	$R_{100} = 1484$ Ω			100	-5		5		%
Power dissipation	P				25		5			mW
Power dissipation constant					25		1,5			mW/K
B-value	$B_{(25/50)}$	Tol. ±1 %			25		3962			K
B-value	$B_{(25/100)}$	Tol. ±1 %			25		4000			K
Vincotech NTC Reference								I		



Rectifier Diode Characteristics

figure 1. FWD

Typical forward characteristics

$$I_F = f(V_F)$$

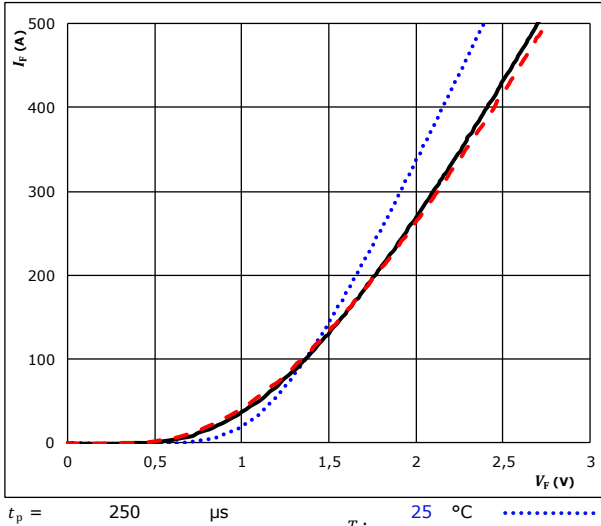
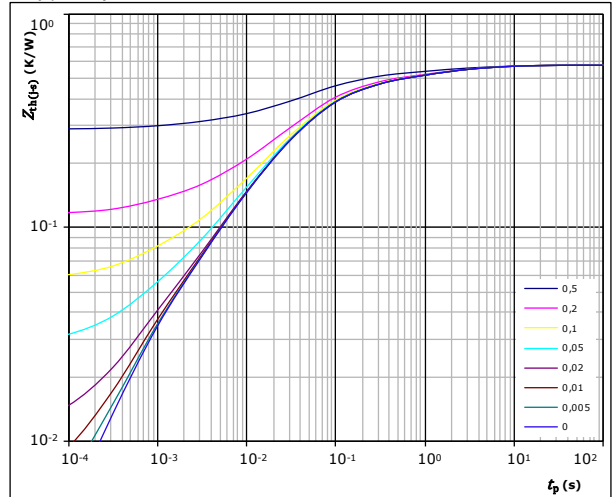

figure 2. FWD

Transient thermal impedance as a function of pulse width

$$Z_{th(j-s)} = f(t_p)$$



$$D = \frac{t_p}{T}$$

$$R_{th(j-s)} = 0,58 \text{ K/W}$$

FWD thermal model values

R (K/W)	τ (s)
3,68E-02	5,30E+00
7,15E-02	1,04E+00
1,20E-01	1,60E-01
2,30E-01	4,28E-02
9,04E-02	8,32E-03
2,63E-02	8,66E-04

Thermistor Characteristics

figure 1. Thermistor

Typical NTC characteristic as a function of temperature

$$R = f(T)$$

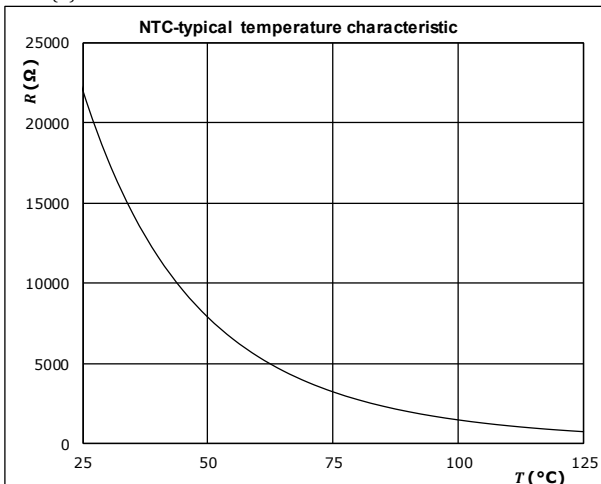



Vincotech

Ordering Code & Marking						
Version			Ordering Code			
without thermal paste 12mm housing with Press-fit pins			10-PG07ORA160RF-LJ53I88T			
with thermal paste 12mm housing with Press-fit pins			10-PG07ORA160RF-LJ53I88T-/3/			
NN-NNNNNNNNNNNN TTTTWW WWYY UL VIN LLLL SSSS						
Text	Name		Date code	UL & VIN	Lot	Serial
	NN-NNNNNNNNNNNN-TTTTWW		WWYY	UL VIN	LLLL	SSSS
Datamatrix	Type&Ver	Lot number	Serial	Date code		
	TTTTTWW	LLLL	SSSS	WWYY		

Pin table			
Pin	X	Y	Function
1	42,8	0	DC-Rect
2	40,1	0	DC-Rect
3	37,4	0	DC-Rect
4	34,7	0	DC-Rect
5	29,6	0	Therm1
6	22,6	0	Therm2
7	17,5	0	DC-Rect
8	14,8	0	DC-Rect
9	12,1	0	DC-Rect
10	9,4	0	DC-Rect
11	0	0	DC+Rect
12	0	2,7	DC+Rect
13	0	5,4	DC+Rect
14	0	8,1	DC+Rect
15	0	28,2	ACin1
16	2,7	28,2	ACin1
17	5,4	28,2	ACin1
18	8,1	28,2	ACin1
19	10,8	28,2	ACin1
20	13,5	28,2	ACin1
21	16,2	28,2	ACin1
22	36	28,2	ACin2
23	38,7	28,2	ACin2
24	41,4	28,2	ACin2
25	44,1	28,2	ACin2
26	46,8	28,2	ACin2
27	49,5	28,2	ACin2
28	52,2	28,2	ACin2
29	52,2	8,1	DC+Rect
30	52,2	5,4	DC+Rect
31	52,2	2,7	DC+Rect
32	52,2	0	DC+Rect

Outline

center of press-fit pinhead
for connection parameter see the handling instruction

13,2 ± 0,1
16,4 ± 0,5

14,1

26,1

Y

X

Tolerance of pinpositions: ±0,4mm at the end of pins
Dimension of coordinate axis is only offset without tolerance



Vincotech

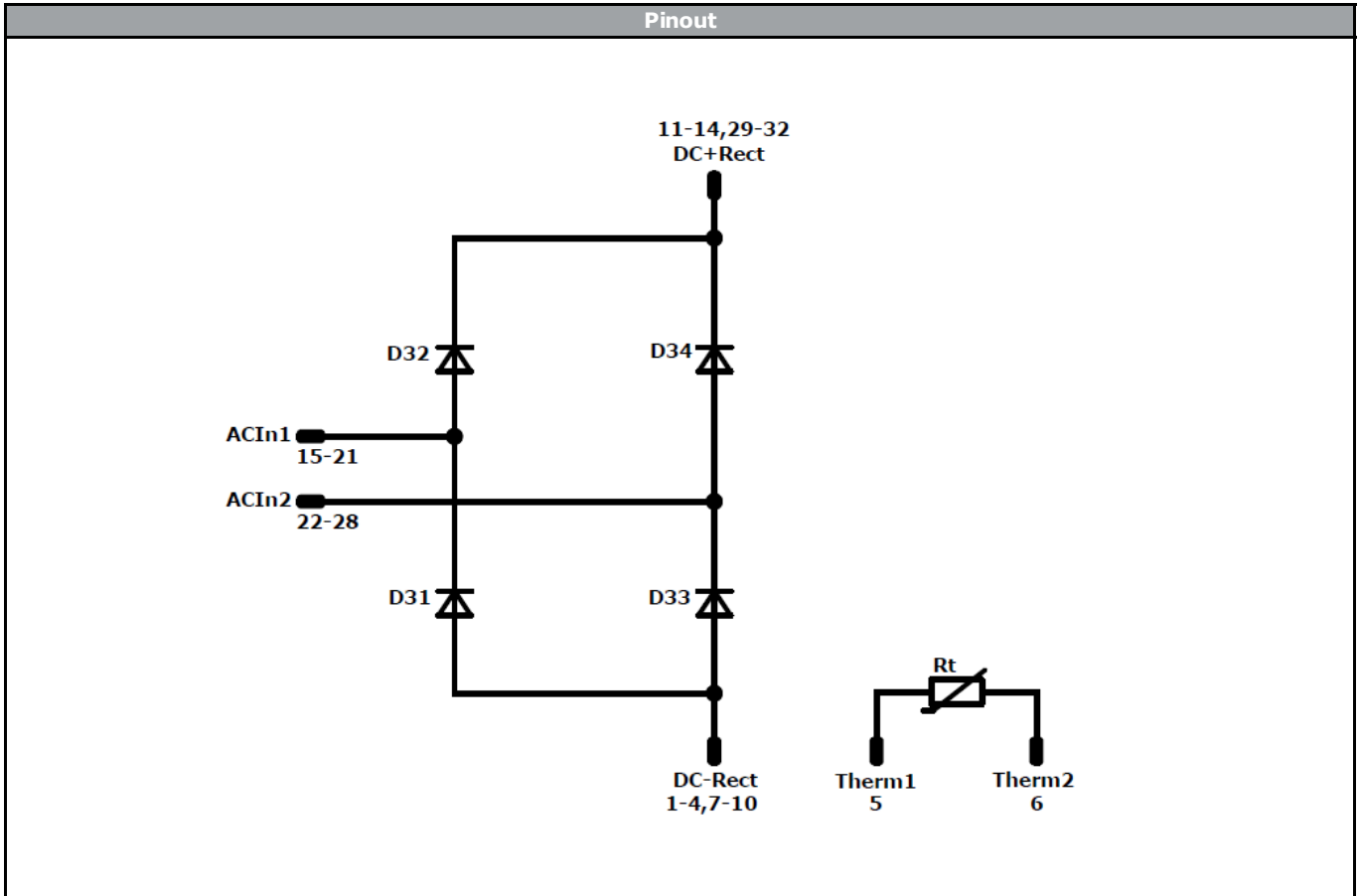

Identification					
ID	Component	Voltage	Current	Function	Comment
D31, D32, D33, D34	Rectifier	650 V	160 A	Rectifier Diode	
Rt	NTC			Thermistor	



Vincotech

Packaging instruction			
Standard packaging quantity (SPQ) 100	>SPQ	Standard	<SPQ Sample

Handling instruction
Handling instructions for <i>flow 1</i> Packaging instructions packages see vincotech.com website.

Package data
Package data for <i>flow 1</i> Packaging instructions packages see vincotech.com website.

UL recognition and file number
This device is certified according to UL 1557 standard, UL file number E192116. For more information see vincotech.com website. 

Document No.:	Date:	Modification:	Pages
10-PG07ORA160RF-LJ53I88T-D1-14	05 Mar. 2019		

DISCLAIMER

The information, specifications, procedures, methods and recommendations herein (together "information") are presented by Vincotech to reader in good faith, are believed to be accurate and reliable, but may well be incomplete and/or not applicable to all conditions or situations that may exist or occur. Vincotech reserves the right to make any changes without further notice to any products to improve reliability, function or design. No representation, guarantee or warranty is made to reader as to the accuracy, reliability or completeness of said information or that the application or use of any of the same will avoid hazards, accidents, losses, damages or injury of any kind to persons or property or that the same will not infringe third parties rights or give desired results. It is reader's sole responsibility to test and determine the suitability of the information and the product for reader's intended use.

LIFE SUPPORT POLICY

Vincotech products are not authorised for use as critical components in life support devices or systems without the express written approval of Vincotech.

As used herein:

1. Life support devices or systems are devices or systems which, (a) are intended for surgical implant into the body, or (b) support or sustain life, or (c) whose failure to perform when properly used in accordance with instructions for use provided in labelling can be reasonably expected to result in significant injury to the user.
2. A critical component is any component of a life support device or system whose failure to perform can be reasonably expected to cause the failure of the life support device or system, or to affect its safety or effectiveness.

单击下面可查看定价，库存，交付和生命周期等信息

[>>Vincotech\(威科\)](#)