

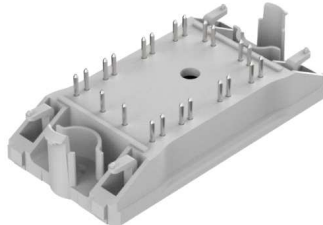
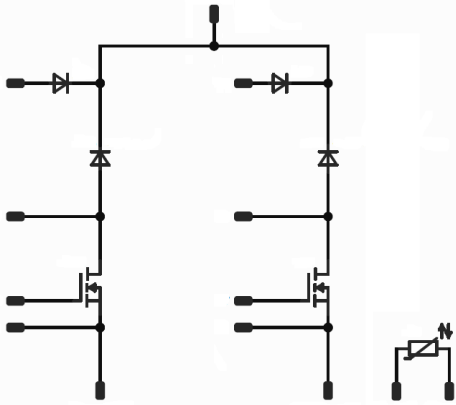

Vincotech

<i>flow</i> BOOST 0 SiC	1200 V / 80 mΩ
<div style="background-color: #eee; padding: 2px; margin-bottom: 5px;">Features</div> <ul style="list-style-type: none"> High efficiency dual boost Ultra fast switching frequency Low Inductive Layout 1200V SiC MOSFET (Rohm) and 1200V SiC diode (Rohm) Integrated bypass diode 	<div style="background-color: #eee; padding: 2px; margin-bottom: 5px;">flow 0 12mm housing</div> 
<div style="background-color: #eee; padding: 2px; margin-bottom: 5px;">Target applications</div> <ul style="list-style-type: none"> Solar Inverter UPS 	<div style="background-color: #eee; padding: 2px; margin-bottom: 5px;">Schematic</div> 
<div style="background-color: #eee; padding: 2px; margin-bottom: 5px;">Types</div> <ul style="list-style-type: none"> V23990-P629-L81-PM 	

Maximum Ratings

$T_j=25^{\circ}\text{C}$, unless otherwise specified

Parameter	Symbol	Condition	Value	Unit
Boost Switch				
Drain-source voltage	V_{DSS}		1200	V
Drain current	I_D	$T_j = T_{jmax}$ $T_s = 80^{\circ}\text{C}$	20	A
Peak drain current	I_{DM}	t_p limited by T_{jmax}	140	A
Total power dissipation	P_{tot}	$T_j = T_{jmax}$ $T_s = 80^{\circ}\text{C}$	68	W
Gate-source voltage	V_{GSS}		-6/+22	V
Maximum Junction Temperature	T_{jmax}		175	$^{\circ}\text{C}$



Vincotech

Parameter	Symbol	Condition	Value	Unit
Boost Diode				
Peak Repetitive Reverse Voltage	V_{RRM}		1200	V
Continuous (direct) forward current	I_F	$T_j = T_{jmax}$ $T_s = 80^\circ\text{C}$	19	A
Repetitive peak forward current	I_{FRM}		50	A
Total power dissipation	P_{tot}	$T_j = T_{jmax}$ $T_s = 80^\circ\text{C}$	56	W
Maximum Junction Temperature	T_{jmax}		175	$^\circ\text{C}$

Bypass Diode

Peak Repetitive Reverse Voltage	V_{RRM}		1600	V
Continuous (direct) forward current	I_F	$T_j = T_{jmax}$ $T_s = 80^\circ\text{C}$	33	A
Surge (non-repetitive) forward current	I_{FSM}	60 Hz Single Half Sine Wave $t_p = 8,3 \text{ ms}$ $T_j = 150^\circ\text{C}$	200	A
Surge current capability	$I^2 t$		200	A^2s
Total power dissipation	P_{tot}	$T_j = T_{jmax}$ $T_s = 80^\circ\text{C}$	43	W
Maximum Junction Temperature	T_{jmax}		150	$^\circ\text{C}$

Module Properties

Thermal Properties

Storage temperature	T_{stg}		-40...+125	$^\circ\text{C}$
Operation temperature under switching condition	T_{jop}		-40...+($T_{jmax} - 25$)	$^\circ\text{C}$

Isolation Properties

Isolation voltage	V_{isol}	DC voltage	$t_p=2\text{s}$	4000	V
Creepage distance				min 12,7	mm
Clearance				9,55	mm
Comparative Tracking Index	CTI			>200	



Characteristic Values

Parameter	Symbol	Conditions				Value			Unit
		V_{GE} [V]	V_{CE} [V]	I_C [A]	T_j [°C]	Min	Typ	Max	

Boost Switch

Static

Drain-source on-state resistance	$r_{DS(on)}$		18		10	25 125 150		79 108 121	111	mΩ
Gate-source threshold voltage	$V_{GS(th)}$	$V_{GS} = V_{DS}$			0,0044	25 125	1,7*	3	4**	V
Gate to Source Leakage Current	I_{GSS}		-6/+22	0		25 125			±100	nA
Zero Gate Voltage Drain Current	I_{DSS}		0	1200		25 125			10	μA
Internal gate resistance	r_g							9		Ω
Gate charge	Q_g							110		nC
Gate to source charge	Q_{GS}		18	400	10	25		24		
Gate to drain charge	Q_{GD}							38		
Short-circuit input capacitance	C_{iss}	f=1MHz						2070		pF
Short-circuit output capacitance	C_{oss}		0	800		25		80		
Reverse transfer capacitance	C_{rss}							20		

* $V_{GS} = -6V$ for 100msec is applied. Measuring time: 2.5msec.

** $V_{GS} = +22V$ for 100msec is applied. Measuring time: 2.5msec.

Thermal

Thermal resistance junction to sink	$R_{th(j-s)}$	phase-change material $\lambda=3,4$ W/mK						1,41		K/W
-------------------------------------	---------------	--	--	--	--	--	--	------	--	-----

MOSFET Switching

Turn-on delay time	$t_{d(on)}$	$R_{goff} = 4 \Omega$ $R_{gon} = 4 \Omega$	+16/0	700	16	25 125		15 14		ns
Rise time	t_r					25 125		8 7		
Turn-off delay time	$t_{d(off)}$					25 125		113 129		
Fall time	t_f					25 125		5 5		
Turn-on energy (per pulse)	E_{on}	$Q_{rFWD} = 0,1 \mu C$ $Q_{rFWD} = 0,1 \mu C$				25 125		0,399 0,303		mWs
Turn-off energy (per pulse)	E_{off}					25 125		0,174 0,186		



Vincotech

Boost Diode

Parameter	Symbol	Conditions				Value			Unit	
		V_{GE} [V]	V_{CE} [V]	I_C [A]	T_J [°C]	Min	Typ	Max		
Static										
Forward voltage	V_F			10	25 125 150		1,40 1,70 1,83	1,6		V
Reverse leakage current	I_r		1200		25 150			200		μA

Thermal

Thermal resistance junction to sink	$R_{th(j-s)}$	phase-change material $\lambda=3,4\text{W/mK}$						1,7		K/W
-------------------------------------	---------------	---	--	--	--	--	--	-----	--	-----

FWD Switching

Peak recovery current	I_{RRM}	$di/dt = 1914\text{ A}/\mu\text{s}$ $di/dt = 2353\text{ A}/\mu\text{s}$	+16/0	700	16	25		9		A
Reverse recovery time	t_{rr}					125		10		ns
Recovered charge	Q_r					25		9		μC
Reverse recovered energy	E_{rec}					125		0,083 0,102		mWs
Peak rate of fall of recovery current	$(di_{rr}/dt)_{max}$					25		0,029		A/μs
		125		3218 3711						

Bypass Diode

Static

Forward voltage	V_F			25	25 125		1,22 1,21	1,9		V
Reverse leakage current	I_r		1600		25 150			50 1100		μA

Thermal

Thermal resistance junction to sink	$R_{th(j-s)}$	phase-change material $\lambda = 3,4\text{ W/mK}$						1,61		K/W
-------------------------------------	---------------	--	--	--	--	--	--	------	--	-----

Thermistor

Rated resistance	R				25		21,5			kΩ
Deviation of R100	$\Delta_{R/R}$	R100=1486 Ω			100	-4,5		+4,5		%
Power dissipation	P				25		210			mW
Power dissipation constant					25		3,5			mW/K
B-value	$B_{(25/50)}$				25		3884			K
B-value	$B_{(25/100)}$				25		3964			K
Vincotech NTC Reference								F		



Boost Switch Characteristics

Typical output characteristics MOSFET

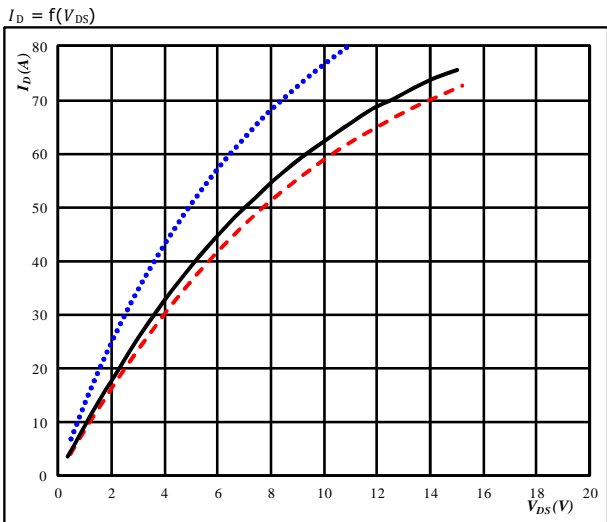

$t_p = 250 \mu s$
 $V_{GS} = 18 V$
 $T_j: 25 \text{ }^\circ C$ (dotted blue)
 $125 \text{ }^\circ C$ (solid black)
 $150 \text{ }^\circ C$ (dashed red)

Typical output characteristics MOSFET

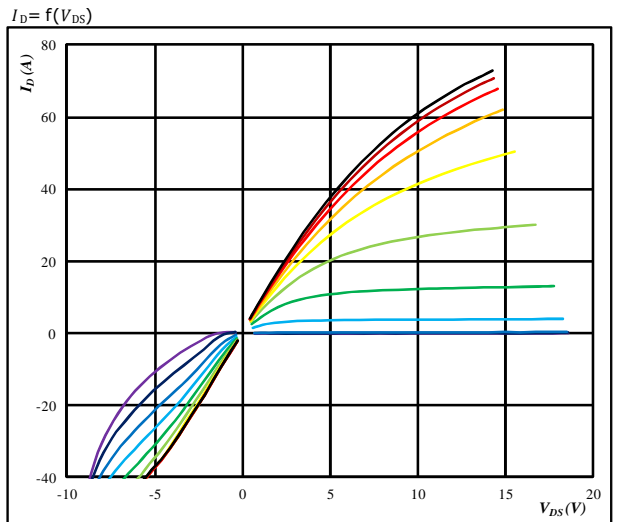

$t_p = 250 \mu s$
 $T_j = 150 \text{ }^\circ C$
 V_{GS} from 0 V to 20 V in steps of 2 V

Typical transfer characteristics MOSFET

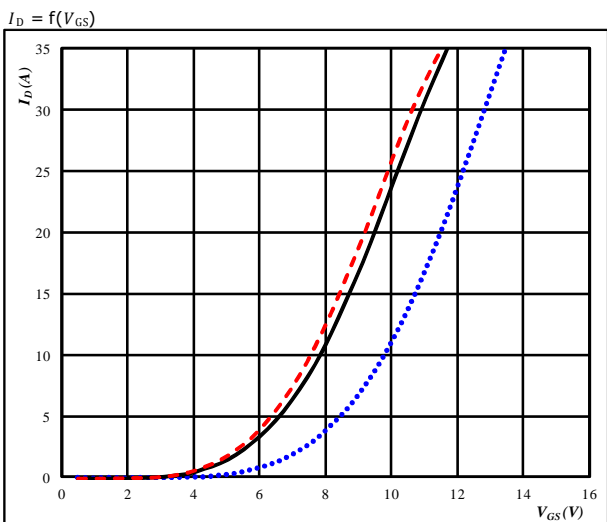

$t_p = 100 \mu s$
 $V_{DS} = 10 V$
 $T_j: 25 \text{ }^\circ C$ (dotted blue)
 $125 \text{ }^\circ C$ (solid black)
 $150 \text{ }^\circ C$ (dashed red)

Transient thermal impedance as a function of pulse width MOSFET

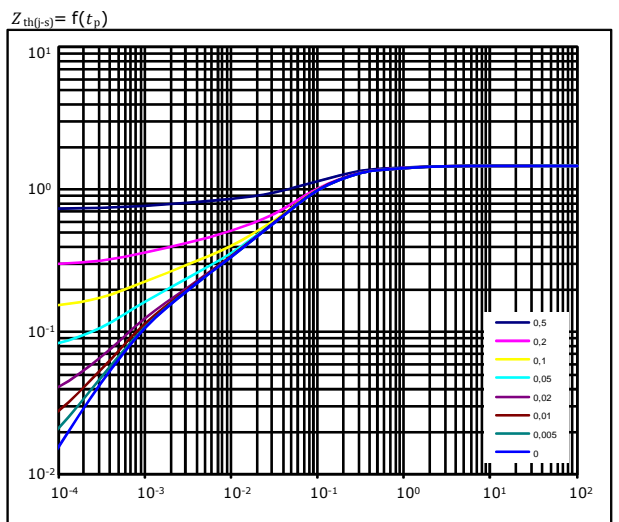

$D = t_p / T$
 $R_{th(f-s)} = 1,48 K/W$

R (K/W)	Tau(s)
1,30E-01	1,00E+00
4,11E-01	1,66E-01
7,09E-01	6,11E-02
1,27E-01	5,50E-03
1,00E-01	8,02E-04



Boost Diode Characteristics

Typical forward characteristics FWD

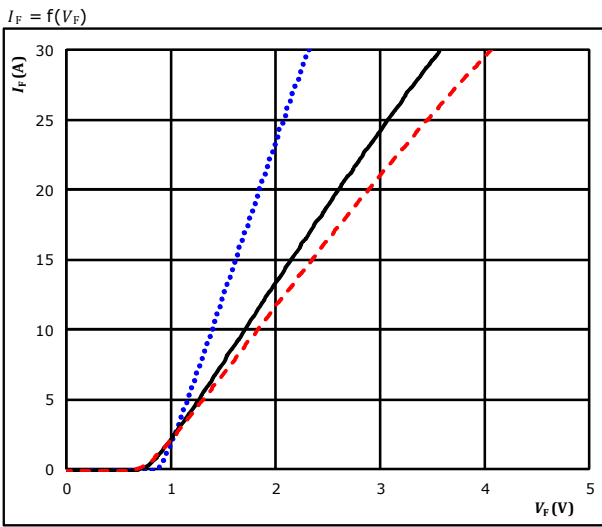

Transient thermal impedance as a function of pulse width FWD

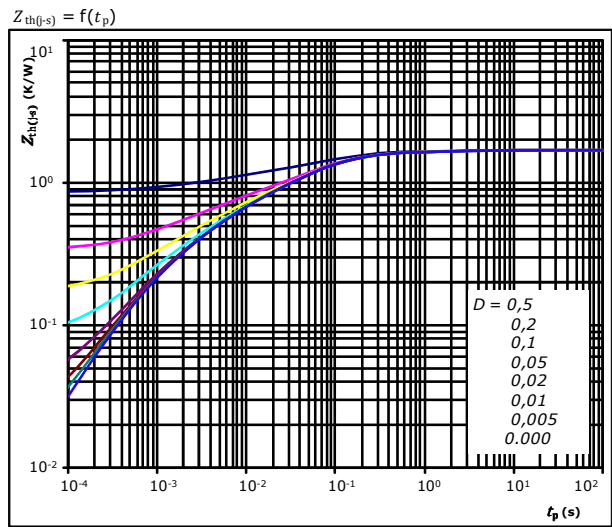

FWD thermal model values

R (K/W)	τ (s)
4,5560E-02	3,2070E+00
1,6530E-01	3,8810E-01
7,8640E-01	6,5190E-02
3,2730E-01	1,1130E-02
2,5420E-01	2,7080E-03
1,2040E-01	6,1510E-04



Bypass Diode Characteristics

Typical forward characteristics Bypass diode

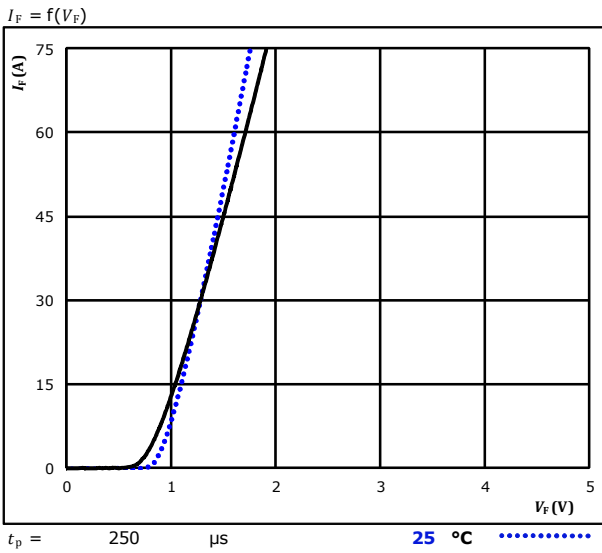

Transient thermal impedance as a function of pulse width Bypass diode

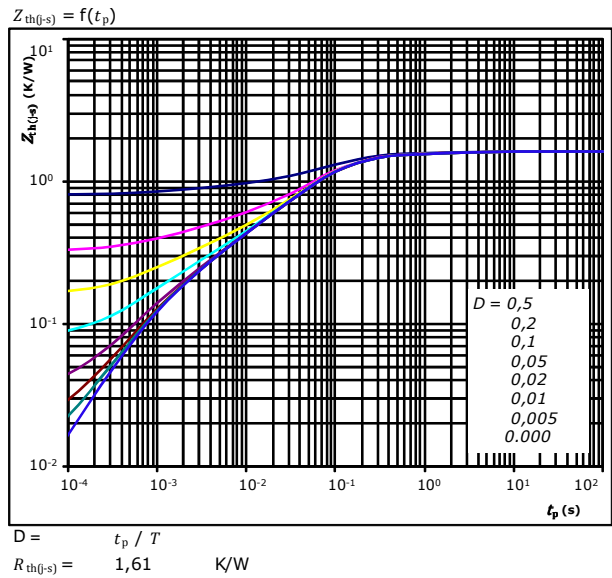

Diode thermal model values

R (K/W)	τ (s)
6,7170E-02	2,7200E+00
1,4760E-01	4,1400E-01
8,6760E-01	8,3320E-02
2,5310E-01	2,8890E-02
1,6900E-01	5,1460E-03
1,0640E-01	9,0980E-04

Thermistor

Thermistor typical temperature characteristic

Typical NTC characteristic
as a function of temperature

$R_T = f(T)$

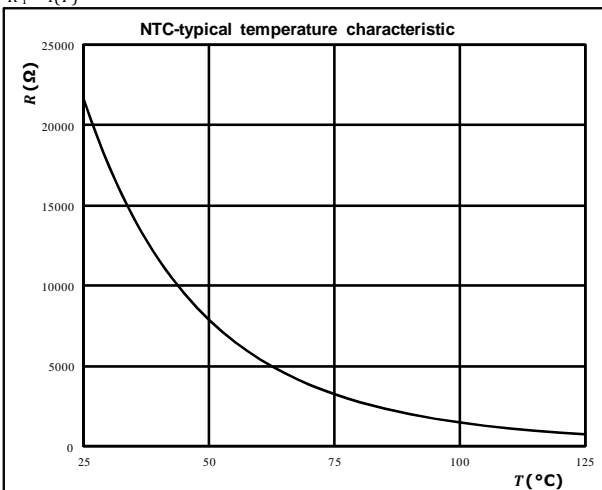



Boost Switching Characteristics

Figure 1. MOSFET

Typical switching energy losses as a function of collector current

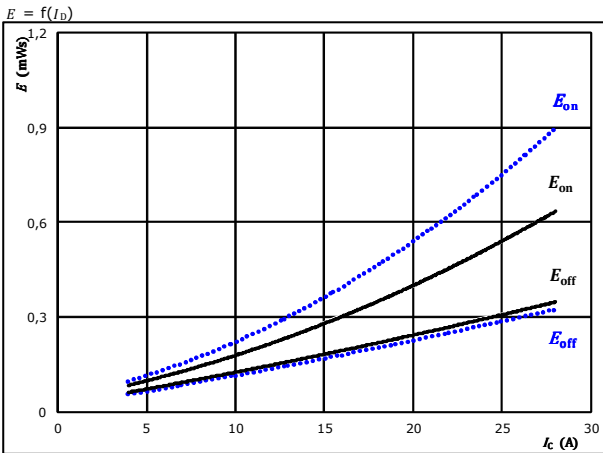

With an inductive load at
 $V_{DS} = 700 \text{ V}$
 $V_{GS} = +16/0 \text{ V}$
 $R_{gon} = 4 \text{ } \Omega$
 $R_{goff} = 4 \text{ } \Omega$
 $T_j: 25 \text{ } ^\circ\text{C}$ (dotted)
 $125 \text{ } ^\circ\text{C}$ (solid)
 $150 \text{ } ^\circ\text{C}$ (dashed)

Figure 2. MOSFET

Typical switching energy losses as a function of gate resistor

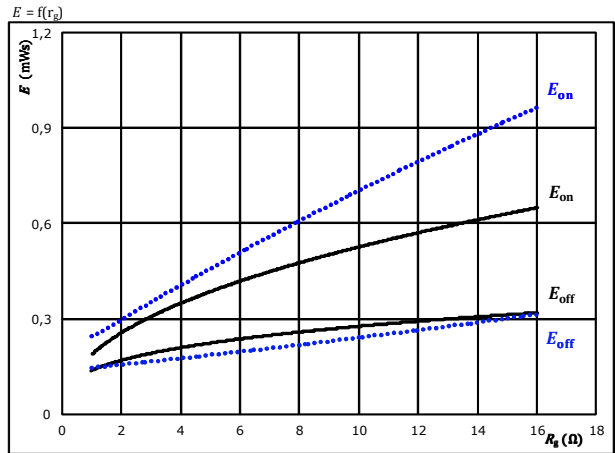

With an inductive load at
 $V_{DS} = 700 \text{ V}$
 $V_{GS} = +16/0 \text{ V}$
 $I_D = 16 \text{ A}$
 $T_j: 25 \text{ } ^\circ\text{C}$ (dotted)
 $125 \text{ } ^\circ\text{C}$ (solid)
 $150 \text{ } ^\circ\text{C}$ (dashed)

Figure 3. FWD

Typical reverse recovered energy loss as a function of collector current

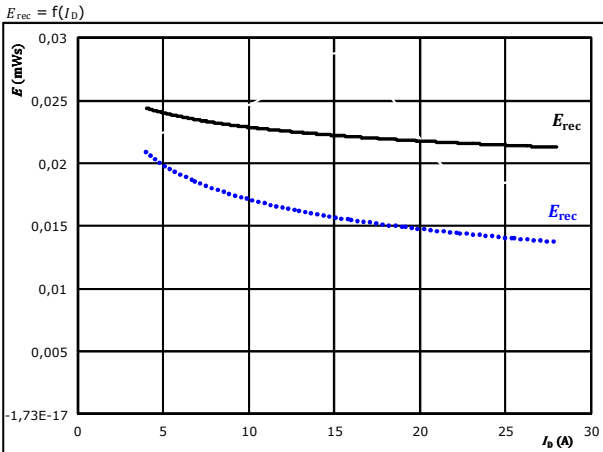

With an inductive load at
 $V_{DS} = 700 \text{ V}$
 $V_{GS} = +16/0 \text{ V}$
 $R_{gon} = 4 \text{ } \Omega$
 $T_j: 25 \text{ } ^\circ\text{C}$ (dotted)
 $125 \text{ } ^\circ\text{C}$ (solid)
 $150 \text{ } ^\circ\text{C}$ (dashed)

Figure 4. FWD

Typical reverse recovered energy loss as a function of gate resistor

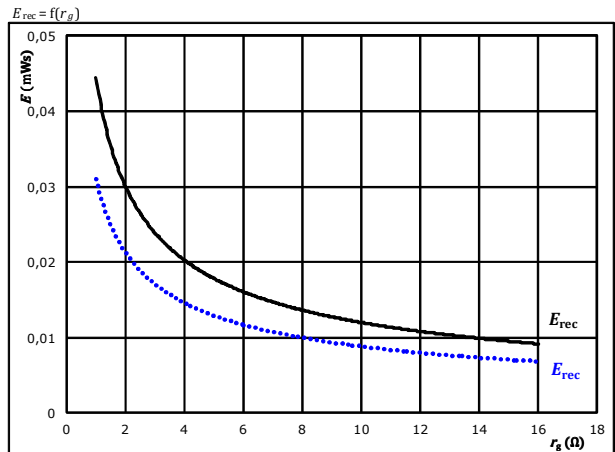

With an inductive load at
 $V_{DS} = 700 \text{ V}$
 $V_{GS} = +16/0 \text{ V}$
 $I_D = 16 \text{ A}$
 $T_j: 25 \text{ } ^\circ\text{C}$ (dotted)
 $125 \text{ } ^\circ\text{C}$ (solid)
 $150 \text{ } ^\circ\text{C}$ (dashed)



Boost Switching Characteristics

Figure 5. MOSFET

Typical switching times as a function of collector current

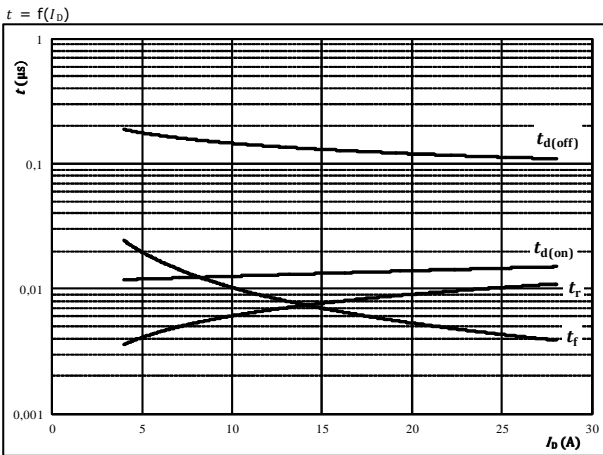

Figure 6. MOSFET

Typical switching times as a function of gate resistor

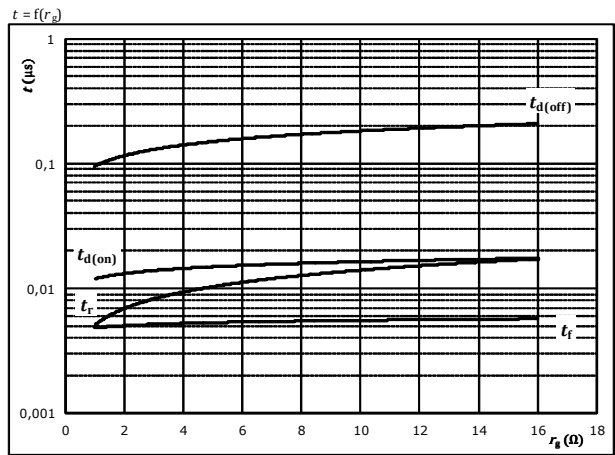

Figure 7. FWD

Typical reverse recovery time as a function of collector current

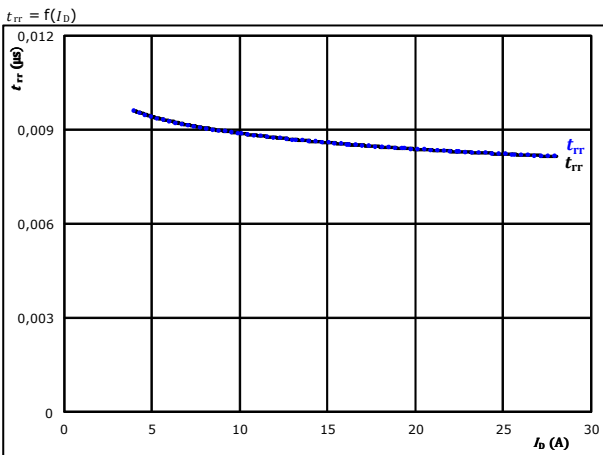
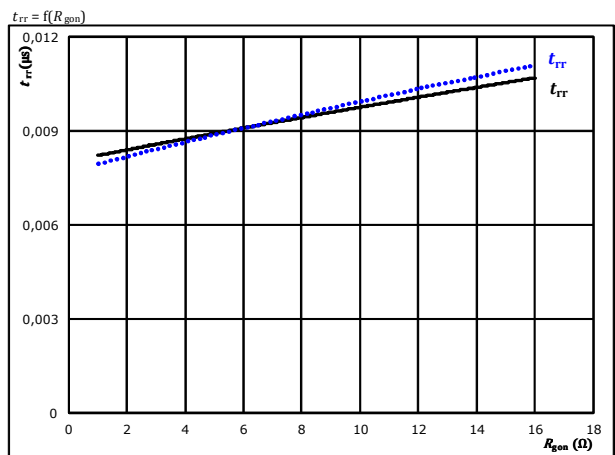

Figure 8. FWD

Typical reverse recovery time as a function of MOSFET turn on gate resistor





Boost Switching Characteristics

Figure 9. FWD
Typical recovered charge as a function of collector current

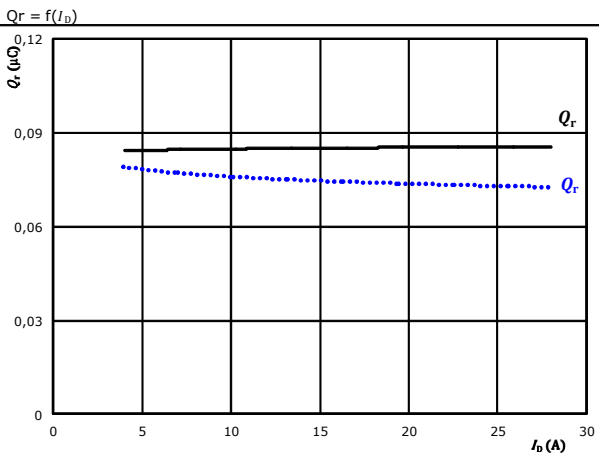

A $V_{DS} = 700$ V
 $V_{GS} = +16/0$ V
 $R_{gon} = 4$ Ω
 T_j : 25 °C (dotted blue line)
125 °C (solid black line)
150 °C (dashed red line)

Figure 10. FWD
Typical recovered charge as a function of MOSFET turn on gate resistor

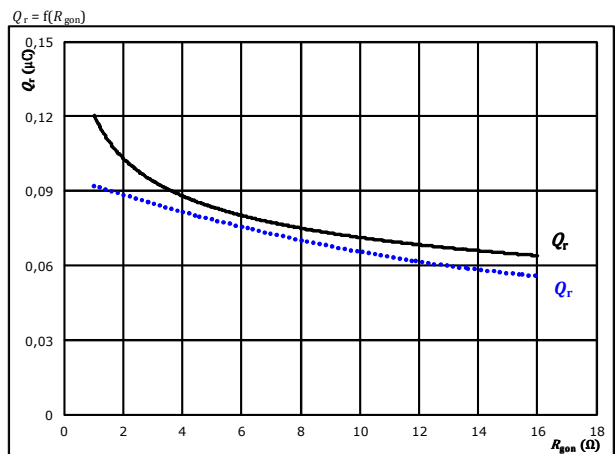

At $V_{DS} = 700$ V
 $V_{GS} = +16/0$ V
 $I_D = 16$ A
 T_j : 25 °C (dotted blue line)
125 °C (solid black line)
150 °C (dashed red line)

Figure 11. FWD
Typical peak reverse recovery current as a function of collector current

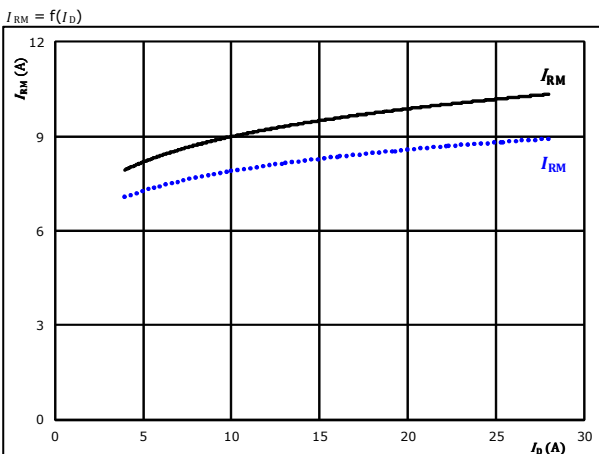

At $V_{DS} = 700$ V
 $V_{GS} = +16/0$ V
 $R_{gon} = 4$ Ω
 T_j : 25 °C (dotted blue line)
125 °C (solid black line)
150 °C (dashed red line)

Figure 12. FWD
Typical peak reverse recovery current as a function of MOSFET turn on gate resistor

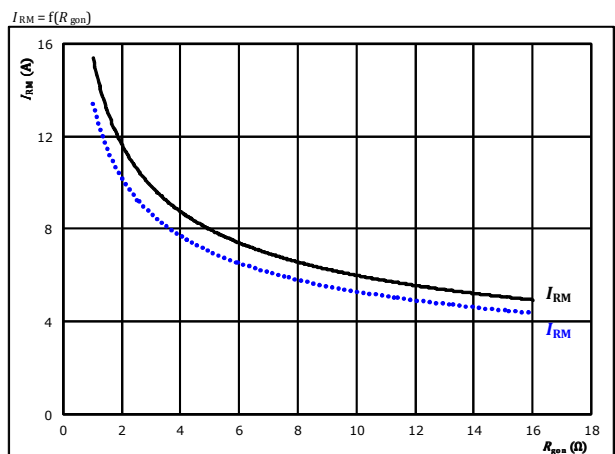

At $V_{DS} = 700$ V
 $V_{GS} = +16/0$ V
 $I_D = 16$ A
 T_j : 25 °C (dotted blue line)
125 °C (solid black line)
150 °C (dashed red line)



Boost Switching Characteristics

Figure 13. FWD

Typical rate of fall of forward and reverse recovery current as a function of collector current

$$di_f/dt, di_{rr}/dt = f(I_c)$$

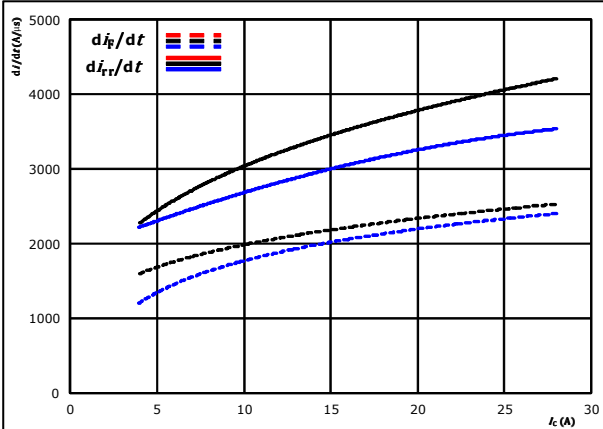

At $V_{DS} = 700$ V $T_j: 25$ °C
 $V_{GS} = +16/0$ V $T_j: 125$ °C ———
 $R_{gon} = 4$ Ω $T_j: 150$ °C - - - - -

Figure 14. FWD

Typical rate of fall of forward and reverse recovery current as a function of MOSFET turn on gate resistor

$$di_f/dt, di_{rr}/dt = f(R_g)$$

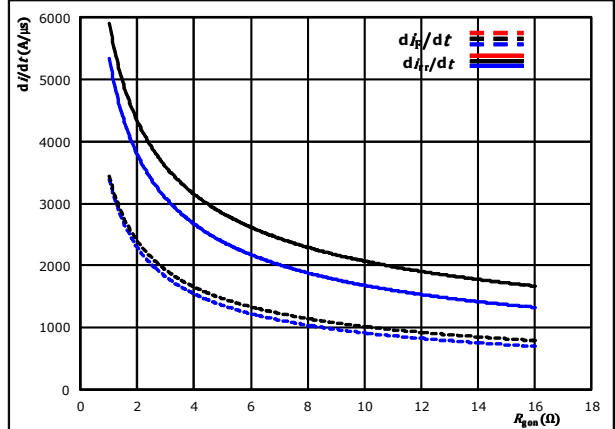

At $V_{DS} = 700$ V $T_j: 25$ °C
 $V_{GS} = +16/0$ V $T_j: 125$ °C ———
 $I_D = 16$ A $T_j: 150$ °C - - - - -



Boost Switching Definitions

General conditions

T_j	=	125 °C
R_{gon}	=	4 Ω
R_{goff}	=	4 Ω

Figure 1. MOSFET
Turn-off Switching Waveforms & definition of t_{doff} , t_{Eoff} (t_{Eoff} = integrating time for Eoff)

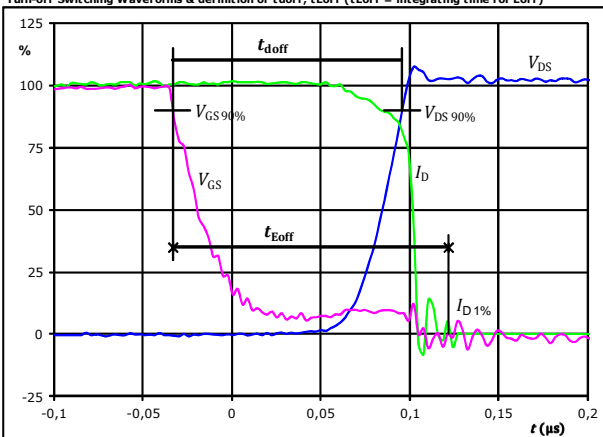

V_{GS} (0%) =	0	V
V_{GS} (100%) =	16	V
V_{DS} (100%) =	700	V
I_D (100%) =	16	A
t_{doff} =	0,129	μ s
t_{Eoff} =	0,155	μ s

Figure 2. MOSFET
Turn-on Switching Waveforms & definition of t_{don} , t_{Eon} (t_{Eon} = integrating time for Eon)

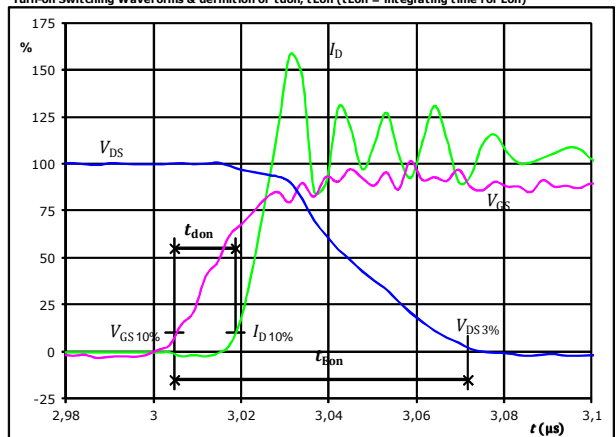

V_{GS} (0%) =	0	V
V_{GS} (100%) =	16	V
V_{DS} (100%) =	700	V
I_D (100%) =	16	A
t_{don} =	0,014	μ s
t_{Eon} =	0,067	μ s

Figure 3. MOSFET
Turn-off Switching Waveforms & definition of t_f

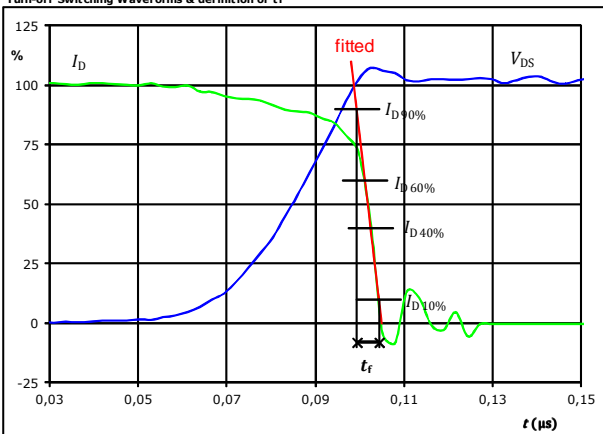

V_C (100%) =	700	V
I_D (100%) =	16	A
t_f =	0,005	μ s

Figure 4. MOSFET
Turn-on Switching Waveforms & definition of t_r

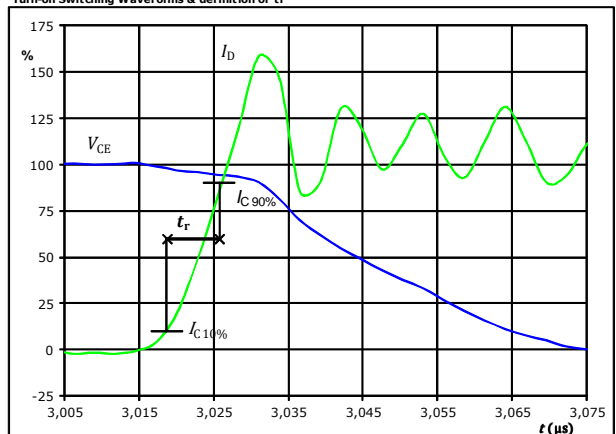

V_C (100%) =	700	V
I_D (100%) =	16	A
t_r =	0,007	μ s



Boost Switching Definitions

Figure 5. MOSFET

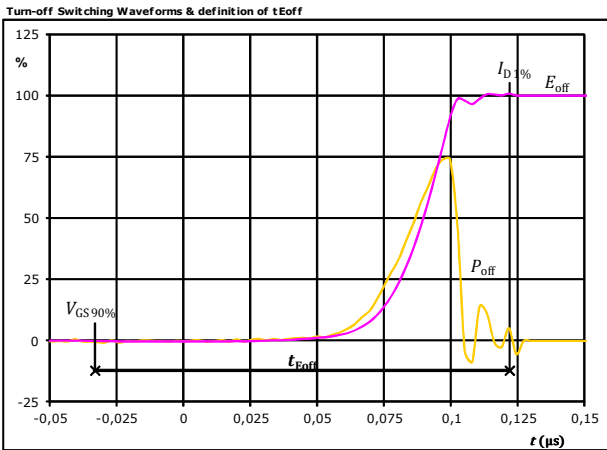

$P_{off} (100\%) =$	11,08	kW
$E_{off} (100\%) =$	0,19	mJ
$t_{Eoff} =$	0,155	μs

Figure 6. MOSFET

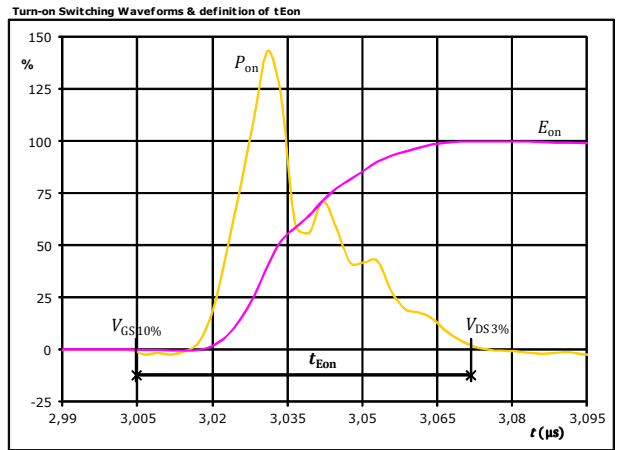

$P_{on} (100\%) =$	11,08	kW
$E_{on} (100\%) =$	0,30	mJ
$t_{Eon} =$	0,067	μs

Figure 7. FWD

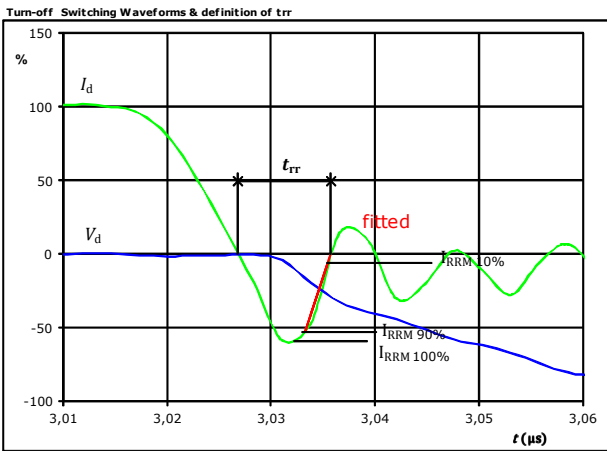

$V_d (100\%) =$	700	V
$I_d (100\%) =$	16	A
$I_{RRM} (100\%) =$	-10	A
$t_{rr} =$	0,009	μs



Boost Switching Definitions

Figure 8. FWD

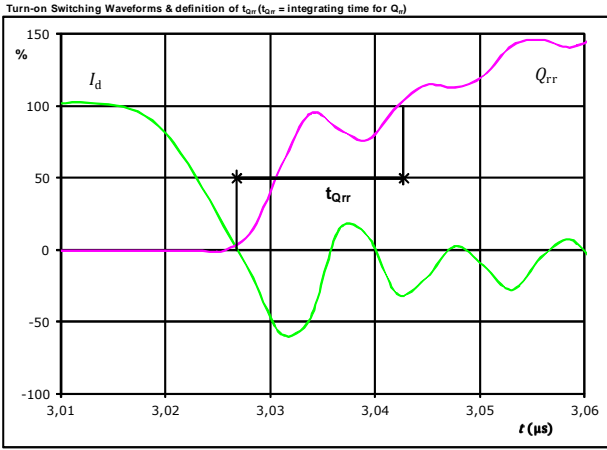

I_d (100%) =	16	A
Q_{rr} (100%) =	0,10	μC
t_{Qrr} =	0,02	μs

Figure 9. FWD

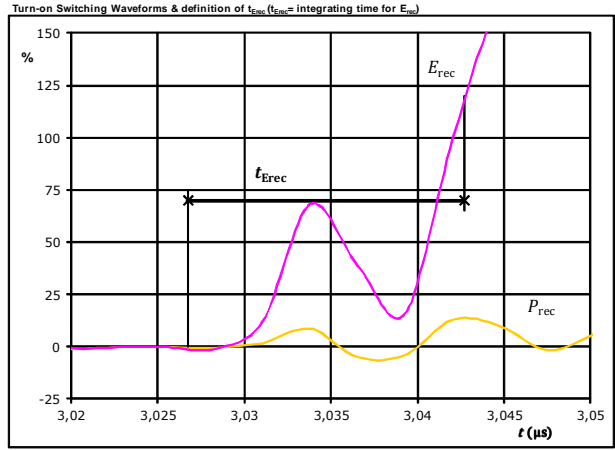

P_{rec} (100%) =	11,08	kW
E_{rec} (100%) =	0,03	mJ
t_{Erec} =	0,02	μs



Vincotech

Ordering Code & Marking										
Version				Ordering Code						
without thermal paste 12mm housing and solder pins				V23990-P629-L81-PM						
Vinco WWWW NNNNNNVV UL LLLL SSSS				Text	Vinco	Date code	Name&Ver	UL	Lot	Serial
					Vinco	WWYY	NNNNNNVV	UL	LLLL	SSSS
				Datamatrix	Type&Ver	Lot number	Serial	Date code		
					TTTTTIVV	LLLL	SSSS	WWYY		

Pin table [mm]			
Pin	X	Y	Function
1	0	22,5	G1
2	2,9	22,5	S1
3	8,3	22,5	DC-Boost1
4	10,8	22,5	DC-Boost1
5	19,6	22,5	DC+Boost
6	22,1	22,5	DC+Boost
7	29,1	22,5	DC+In1
8	32	22,5	DC+In1
9	33,5	17,8	Boost1
10	33,5	15,3	Boost1
11	33,5	7,2	Boost2
12	33,5	4,7	Boost2
13	32	0	DC+In2
14	29,1	0	DC+In2
15	22,1	0	DC+Boost
16	19,6	0	DC+Boost
17	10,8	0	DC-Boost2
18	8,3	0	DC-Boost2
19	2,9	0	S2
20	0	0	G2
21	0	8	Therm1
22	0	14,5	Therm2

Tolerance of pinpositions: ±0,5mm at the end of pins
Dimension of coordinate axis is only offset without tolerance



Vincotech

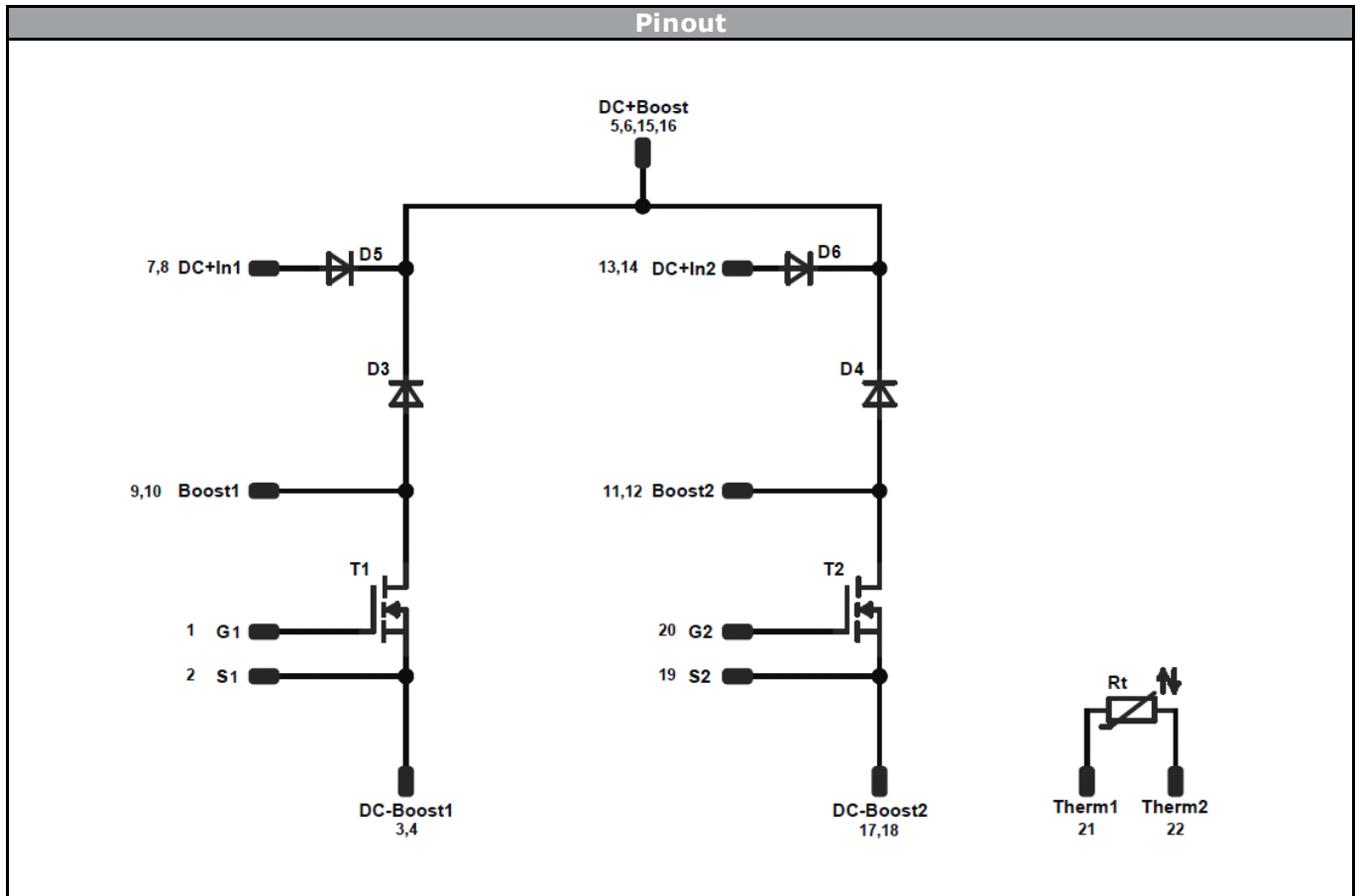

Identification					
ID	Component	Voltage	Current	Function	Comment
T1,T2	MOSFET	1200V	80mΩ	Boost Switch	
D1,D3	FWD	1200V	10A	Boost Diode	
D5,D6	Rectifier	1600V	25A	Bypass Diode	
Rt	NTC	-	-	Thermistor	



Vincotech

Packaging instruction					
Standard packaging quantity (SPQ)	135	>SPQ	Standard	<SPQ	Sample

Handling instruction	
Handling instructions for <i>flow</i> 0 packages see vincotech.com website.	

Package data	
Package data for <i>flow</i> 0 packages see vincotech.com website.	

Document No.:	Date:	Modification:	Pages
V23990-P629-L81-D1-14	19 Nov. 2015		

DISCLAIMER

The information, specifications, procedures, methods and recommendations herein (together "information") are presented by Vincotech to reader in good faith, are believed to be accurate and reliable, but may well be incomplete and/or not applicable to all conditions or situations that may exist or occur. Vincotech reserves the right to make any changes without further notice to any products to improve reliability, function or design. No representation, guarantee or warranty is made to reader as to the accuracy, reliability or completeness of said information or that the application or use of any of the same will avoid hazards, accidents, losses, damages or injury of any kind to persons or property or that the same will not infringe third parties rights or give desired results. It is reader's sole responsibility to test and determine the suitability of the information and the product for reader's intended use.

LIFE SUPPORT POLICY

Vincotech products are not authorised for use as critical components in life support devices or systems without the express written approval of Vincotech.

As used herein:

1. Life support devices or systems are devices or systems which, (a) are intended for surgical implant into the body, or (b) support or sustain life, or (c) whose failure to perform when properly used in accordance with instructions for use provided in labelling can be reasonably expected to result in significant injury to the user.
2. A critical component is any component of a life support device or system whose failure to perform can be reasonably expected to cause the failure of the life support device or system, or to affect its safety or effectiveness.

单击下面可查看定价，库存，交付和生命周期等信息

[>>Vincotech\(威科\)](#)