



Vincotech

10-EZ126PA025M7-L858F78T
10-E1126PA025M7-L858F78Z
 datasheet

<i>flowPACK E1</i>	1200 V / 25 A
<div style="background-color: #eee; padding: 5px; margin-bottom: 10px;">Features</div> <ul style="list-style-type: none"> IGBT M7 with low V_{CEsat} and improved EMC behavior Standard industrial housing Optimized $R_{th(j-s)}$ with Phase Change Material Built-in NTC 	<div style="background-color: #eee; padding: 5px; margin-bottom: 10px;">flow E1 12 mm housing</div> <div style="display: flex; justify-content: space-around; align-items: center;"> </div> <div style="display: flex; justify-content: space-around; margin-top: 5px;"> Press-fit pin Solder pin </div>
<div style="background-color: #eee; padding: 5px; margin-bottom: 10px;">Target applications</div> <ul style="list-style-type: none"> Industrial Drives 	<div style="background-color: #eee; padding: 5px; margin-bottom: 10px;">Schematic</div>
<div style="background-color: #eee; padding: 5px; margin-bottom: 10px;">Types</div> <ul style="list-style-type: none"> 10-EZ126PA025M7-L858F78T 10-E1126PA025M7-L858F78Z 	

Maximum Ratings

$T_j = 25\text{ °C}$, unless otherwise specified

Parameter	Symbol	Condition	Value	Unit
Inverter Switch				
Collector-emitter voltage	V_{CES}		1200	V
Collector current	I_C	$T_j = T_{jmax}$ $T_s = 80\text{ °C}$	33	A
Repetitive peak collector current	I_{CRM}	t_p limited by T_{jmax}	50	A
Total power dissipation	P_{tot}	$T_j = T_{jmax}$ $T_s = 80\text{ °C}$	79	W
Gate-emitter voltage	V_{GES}		±20	V
Short circuit ratings	t_{SC}	$V_{GE} = 15\text{ V}$ $V_{CC} = 800\text{ V}$ $T_j = 150\text{ °C}$	9,5	µs
Maximum junction temperature	T_{jmax}		175	°C



Maximum Ratings

$T_j = 25\text{ °C}$, unless otherwise specified

Parameter	Symbol	Condition	Value	Unit
Inverter Diode				
Peak repetitive reverse voltage	V_{RRM}		1200	V
Continuous (direct) forward current	I_F	$T_j = T_{jmax}$ $T_s = 80\text{ °C}$	35	A
Repetitive peak forward current	I_{FRM}	T_j limited by T_{jmax}	50	A
Total power dissipation	P_{tot}	$T_j = T_{jmax}$ $T_s = 80\text{ °C}$	71	W
Maximum junction temperature	T_{jmax}		175	°C

Module Properties

Thermal Properties

Storage temperature	T_{stg}		-40...+125	°C
Operation temperature under switching condition	T_{jop}		-40...($T_{jmax} - 25$)	°C

Isolation Properties

Isolation voltage	V_{isol}	DC Test Voltage* $t_p = 2\text{ s}$	6000	V
		AC Voltage $t_p = 1\text{ min}$	2500	V
Creepage distance			min. 12,7	mm
Clearance		with solder pins	8,62	mm
		with Press-fit pins	8,62	mm
Comparative Tracking Index	CTI		≥ 600	

*100 % tested in production



Vincotech

10-EZ126PA025M7-L858F78T
10-E1126PA025M7-L858F78Z
 datasheet

Characteristic Values

Parameter	Symbol	Conditions					Value			Unit
		V_{GS} [V]	V_{GE} [V]	V_{DS} [V]	I_C [A]	T_j [°C]	Min	Typ	Max	

Inverter Switch

Static

Parameter	Symbol	V_{GS} [V]	V_{GE} [V]	V_{DS} [V]	I_C [A]	T_j [°C]	Min	Typ	Max	Unit
Gate-emitter threshold voltage	$V_{GE(th)}$		10		0,0025	25	5,4	6,0	6,6	V
Collector-emitter saturation voltage	V_{CESat}	15			25	25 125 150		1,65 1,89 1,95	2,15	V
Collector-emitter cut-off current	I_{CES}	0	1200			25			70	μA
Gate-emitter leakage current	I_{GES}	20	0			25			500	nA
Internal gate resistance	r_g							none		Ω
Input capacitance	C_{ies}							4800		pF
Output capacitance	C_{oes}	0	10		25			170		
Reverse transfer capacitance	C_{res}							57		
Gate charge	Q_g	15	600	25	25	25		180		nC

Thermal

Parameter	Symbol	Value	Unit
Thermal resistance junction to sink	$R_{th(j-s)}$	$\lambda_{paste} = 3,4$ W/mK (PSX)	K/W

Dynamic

Parameter	Symbol	V_{GS} [V]	V_{GE} [V]	V_{DS} [V]	I_C [A]	T_j [°C]	Min	Typ	Max	Unit
Turn-on delay time	$t_{d(on)}$					25 125 150		147 149 145		ns
Rise time	t_r					25 125 150		29 33 34		
Turn-off delay time	$t_{d(off)}$					25 125 150		171 191 196		
Fall time	t_f					25 125 150		95 110 115		
Turn-on energy (per pulse)*	E_{on}					25 125 150		2,06 2,66 2,82		
Turn-off energy (per pulse)*	E_{off}					25 125 150		1,67 2,18 2,29		mWs

* $L_s = 14$ nH



Characteristic Values

Parameter	Symbol	Conditions					Value			Unit
		V_{GE} [V] V_{GS} [V]	V_{CE} [V] V_{DS} [V]	I_C [A] I_D [A]	I_F [A]	T_j [°C]	Min	Typ	Max	

Inverter Diode

Static

Forward voltage	V_F			25	25 125 150		1,63 1,70 1,69	2,1		V
Reverse leakage current	I_R		1200		25			35		μA

Thermal

Thermal resistance junction to sink	$R_{th(j-s)}$	$\lambda_{paste} = 3,4$ W/mK (PSX)					1,34			K/W
-------------------------------------	---------------	---------------------------------------	--	--	--	--	------	--	--	-----

Dynamic

Peak recovery current	I_{RRM}				25 125 150		21 23 23			A
Reverse recovery time	t_{rr}				25 125 150		254 367 404			ns
Recovered charge	Q_r	$di/dt = 645$ A/μs $di/dt = 673$ A/μs $di/dt = 633$ A/μs	±15	600	25	25 125 150	2,54 3,88 4,28			μC
Reverse recovered energy	E_{rec}					25 125 150	0,884 1,45 1,61			mWs
Peak rate of fall of recovery current	$(di_{rr}/dt)_{max}$					25 125 150	217 134 132			A/μs

Thermistor

Rated resistance	R					25	5			kΩ
Deviation of R_{100}	$\Delta_{R/R}$	$R_{100} = 493$ Ω				100	-5	+5		%
Power dissipation	P					25	245			mW
Power dissipation constant						25	1,4			mW/K
B-value	$B_{(25/50)}$	Tol. ±2 %				25	3375			K
B-value	$B_{(25/100)}$	Tol. ±2 %				25	3437			K
Vincotech NTC Reference									K	



Inverter Switch Characteristics

figure 1. IGBT

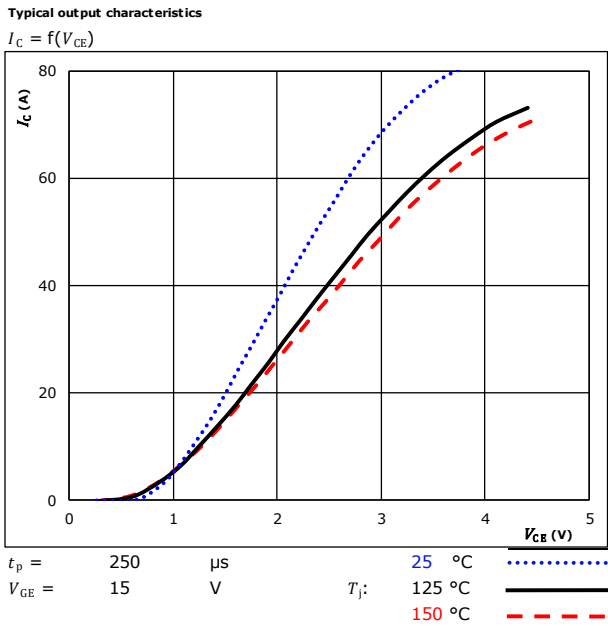

figure 2. IGBT

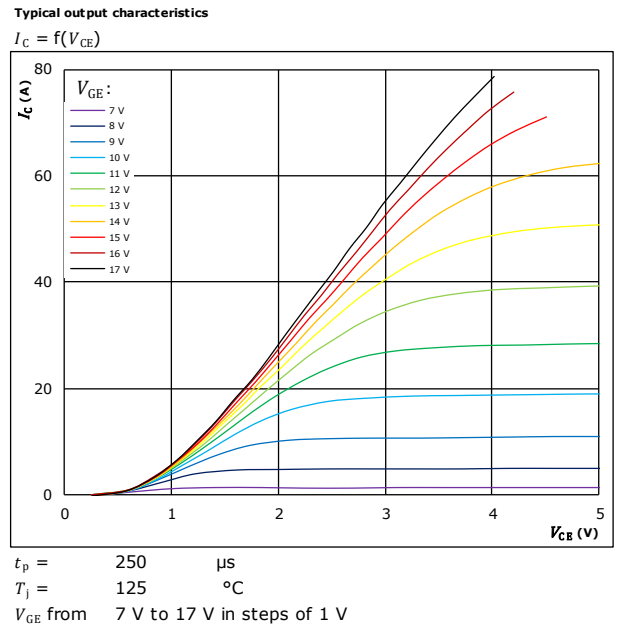

figure 3. IGBT

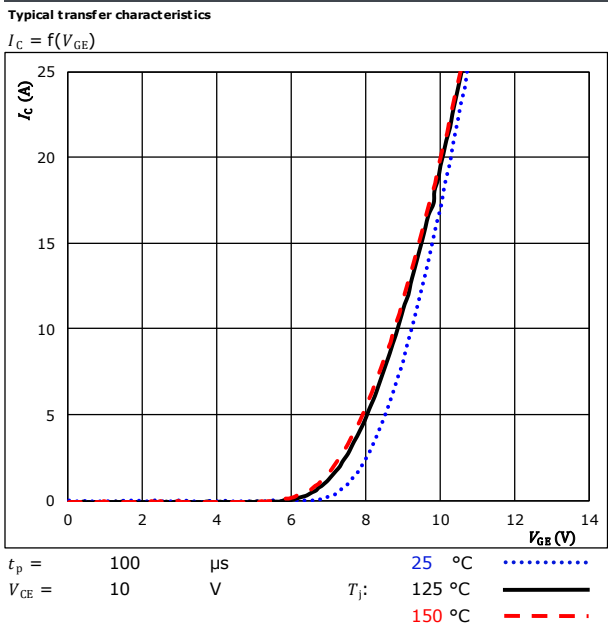
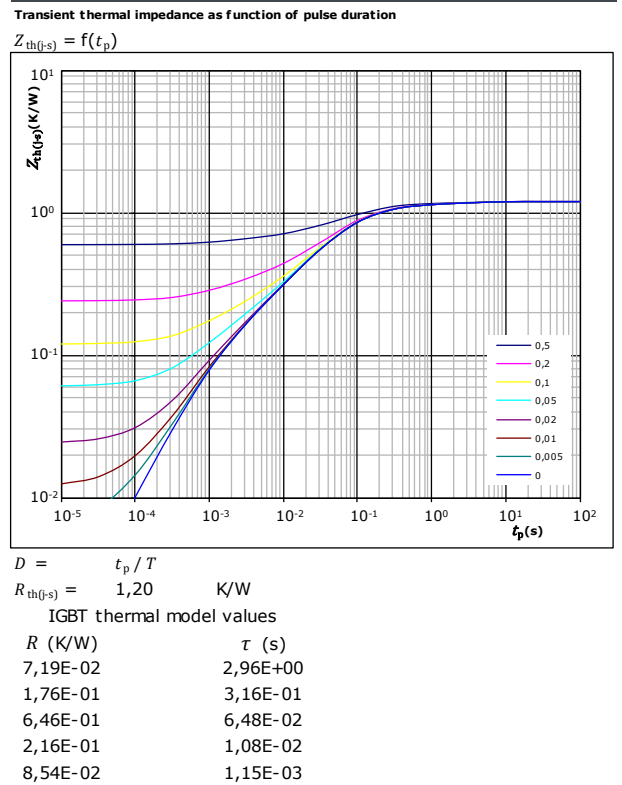

figure 4. IGBT





Inverter Switch Characteristics

figure 5. IGBT

Safe operating area

$$I_C = f(V_{CE})$$

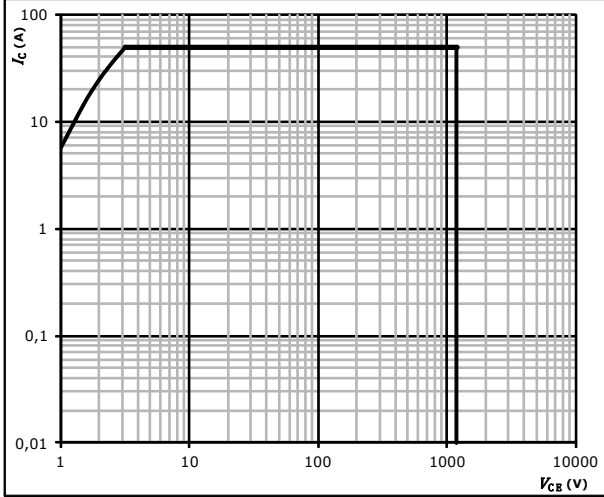

- $D =$ single pulse
- $T_s =$ 80 °C
- $V_{GE} =$ ±15 V
- $T_j = T_{jmax}$



Inverter Diode Characteristics

figure 1. **FWD**

Typical forward characteristics

$$I_F = f(V_F)$$

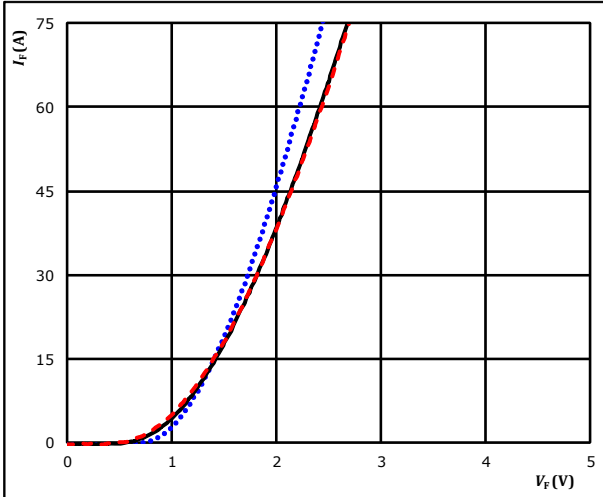

$t_p = 250 \mu s$ T_j : 25 °C (dotted blue line), 125 °C (solid black line), 150 °C (dashed red line)

figure 2. **FWD**

Transient thermal impedance as a function of pulse width

$$Z_{th(j-s)} = f(t_p)$$

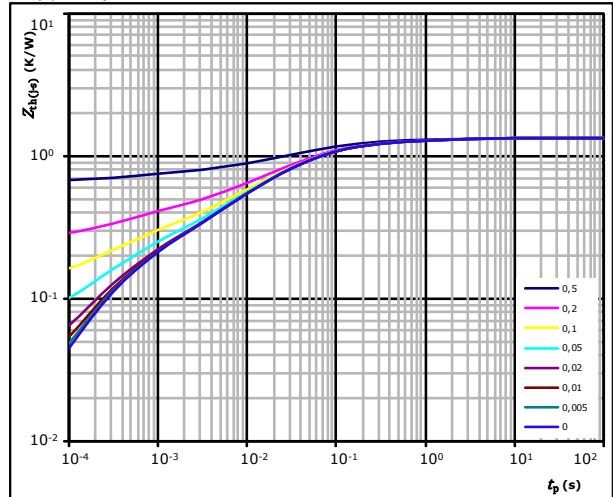

$D = t_p / T$
 $R_{th(j-s)} = 1,34 \text{ K/W}$
 FWD thermal model values

R (K/W)	τ (s)
7,90E-02	2,29E+00
1,38E-01	2,89E-01
5,15E-01	5,53E-02
3,34E-01	1,22E-02
1,30E-01	2,48E-03
1,40E-01	3,42E-04

Thermistor Characteristics

figure 1. **Thermistor**

Typical NTC characteristic as a function of temperature

$$R = f(T)$$

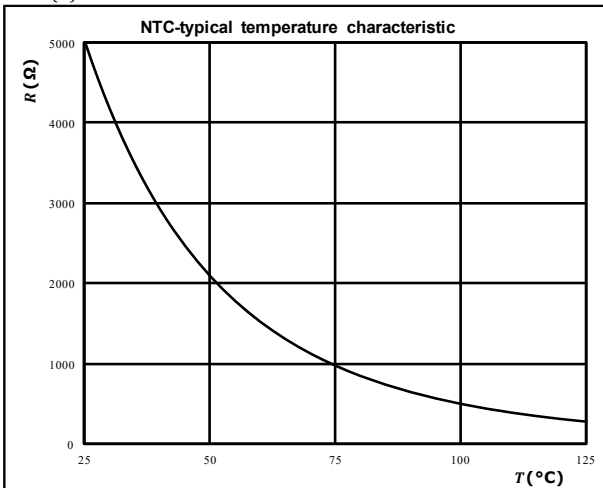



Inverter Switching Characteristics

figure 1. IGBT

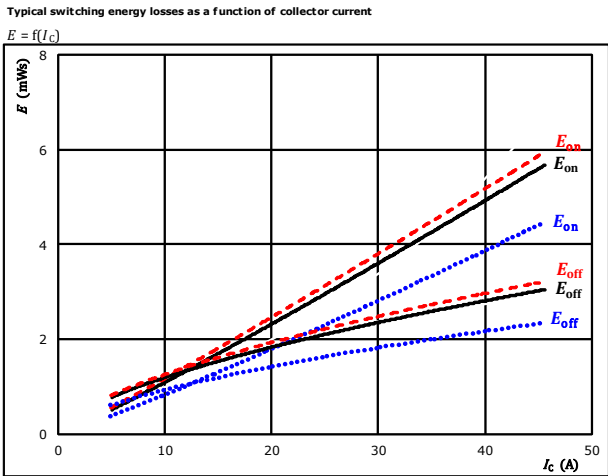

With an inductive load at

$V_{CE} = 600$ V	$T_j = 25$ °C
$V_{GE} = \pm 15$ V	$T_j = 125$ °C	————
$R_{g(on)} = 16$ Ω	$T_j = 150$ °C	-----
$R_{g(off)} = 16$ Ω		

figure 2. IGBT

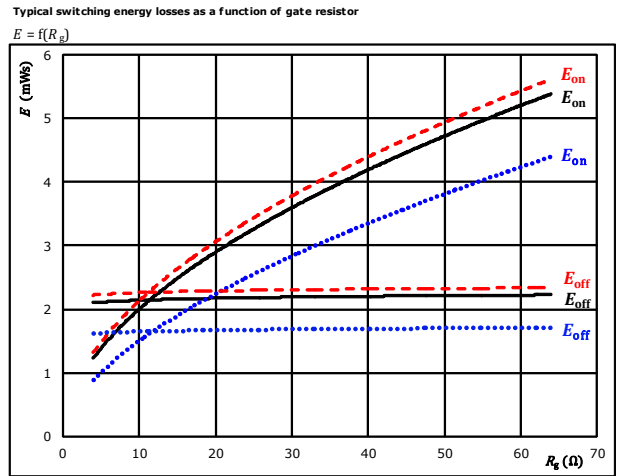

With an inductive load at

$V_{CE} = 600$ V	$T_j = 25$ °C
$V_{GE} = \pm 15$ V	$T_j = 125$ °C	————
$I_C = 25$ A	$T_j = 150$ °C	-----

figure 3. FWD

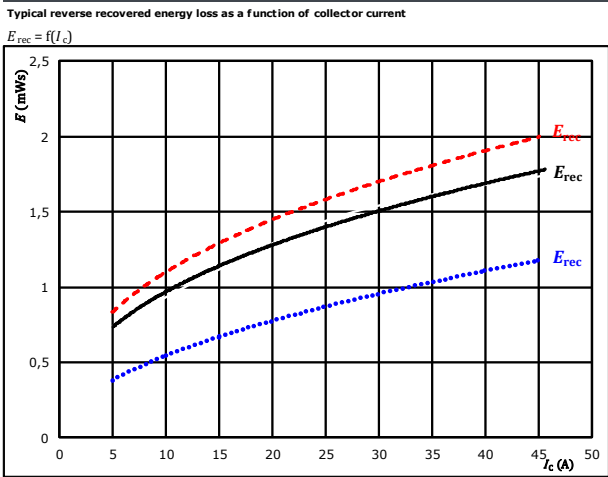

With an inductive load at

$V_{CE} = 600$ V	$T_j = 25$ °C
$V_{GE} = \pm 15$ V	$T_j = 125$ °C	————
$R_{g(on)} = 16$ Ω	$T_j = 150$ °C	-----

figure 4. FWD

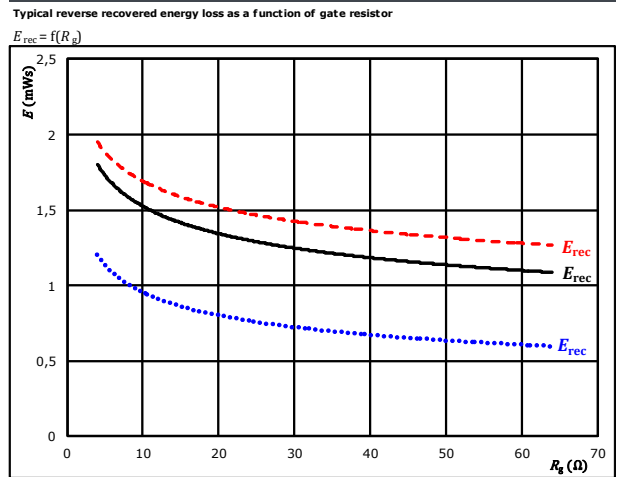

With an inductive load at

$V_{CE} = 600$ V	$T_j = 25$ °C
$V_{GE} = \pm 15$ V	$T_j = 125$ °C	————
$I_C = 25$ A	$T_j = 150$ °C	-----



Inverter Switching Characteristics

figure 5. IGBT

Typical switching times as a function of collector current

$$t = f(I_C)$$

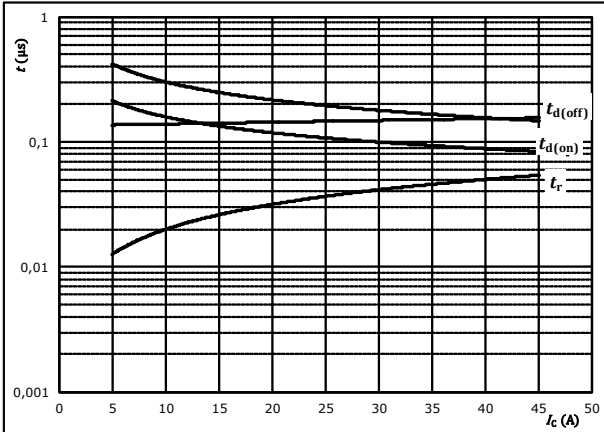

With an inductive load at

$T_j =$	150	°C
$V_{CE} =$	600	V
$V_{GE} =$	±15	V
$R_{g(on)} =$	16	Ω
$R_{g(off)} =$	16	Ω

figure 6. IGBT

Typical switching times as a function of gate resistor

$$t = f(R_g)$$

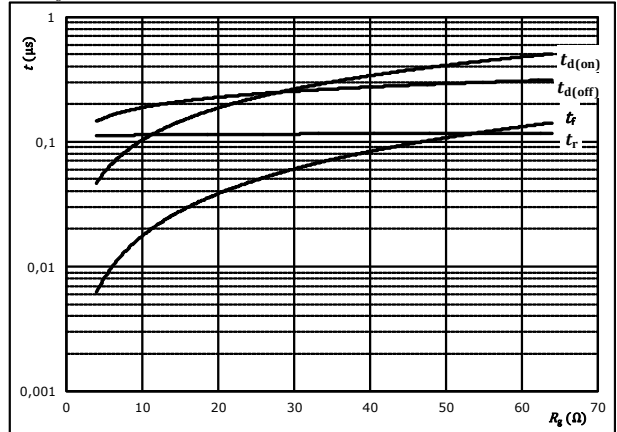

With an inductive load at

$T_j =$	150	°C
$V_{CE} =$	600	V
$V_{GE} =$	±15	V
$I_C =$	25	A

figure 7. FWD

Typical reverse recovery time as a function of collector current

$$t_{rr} = f(I_C)$$

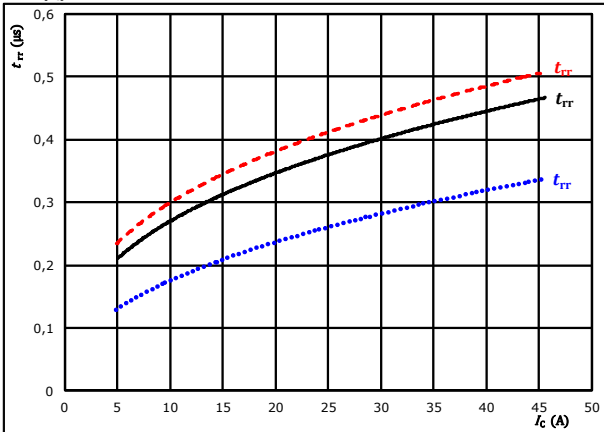

At	$V_{CE} =$	600	V	$T_j =$	25 °C
	$V_{GE} =$	±15	V		125 °C	————
	$R_{g(on)} =$	16	Ω		150 °C	-----

figure 8. FWD

Typical reverse recovery time as a function of IGBT turn on gate resistor

$$t_{rr} = f(R_{g(on)})$$

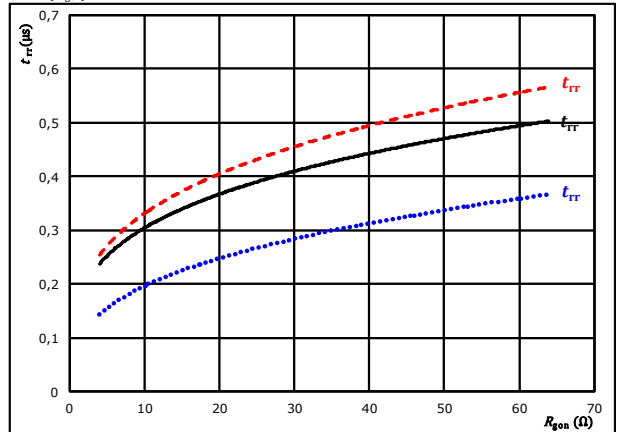

At	$V_{CE} =$	600	V	$T_j =$	25 °C
	$V_{GE} =$	±15	V		125 °C	————
	$I_C =$	25	A		150 °C	-----



Inverter Switching Characteristics

figure 9. FWD

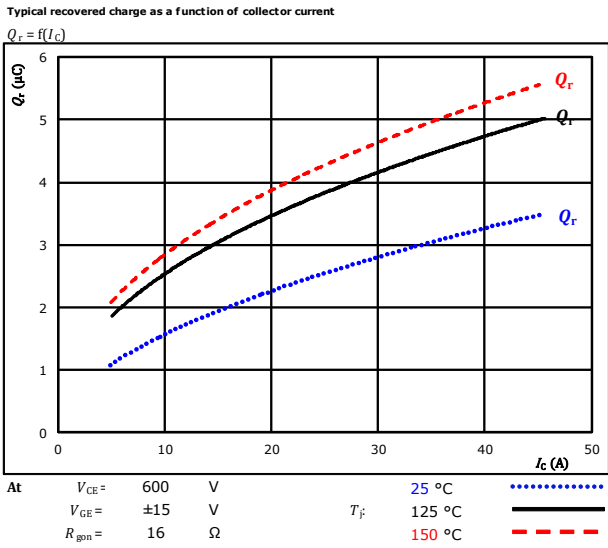

figure 10. FWD

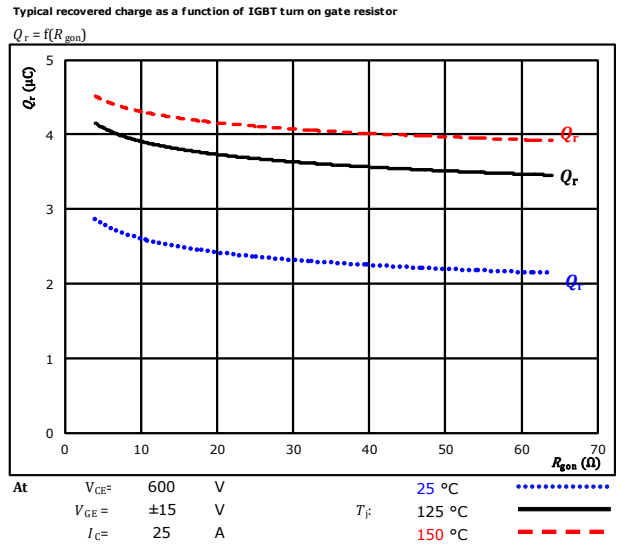

figure 11. FWD

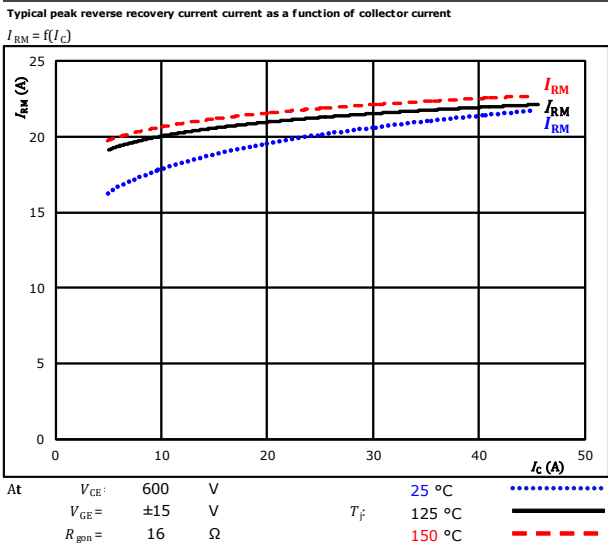
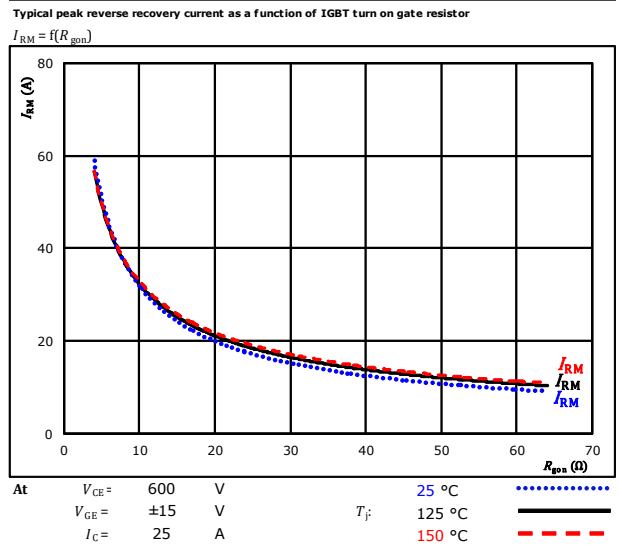

figure 12. FWD





Inverter Switching Characteristics

figure 13. FWD

Typical rate of fall of forward and reverse recovery current as a function of collector current
 $di_f/dt, di_{rr}/dt = f(I_c)$

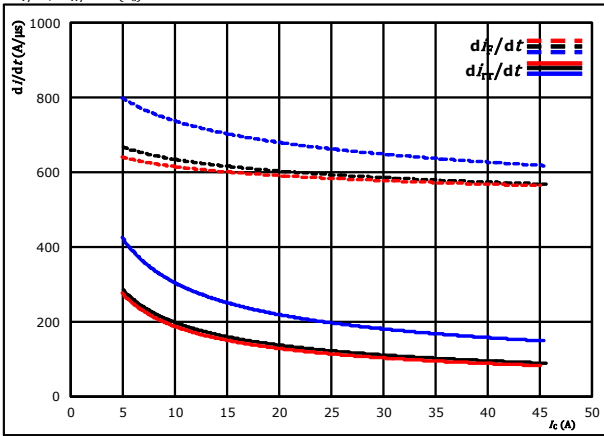

At $V_{CE} = 600$ V $T_j = 25$ °C
 $V_{GE} = \pm 15$ V $T_j = 125$ °C
 $R_{gon} = 16$ Ω $T_j = 150$ °C

figure 14. FWD

Typical rate of fall of forward and reverse recovery current as a function of IGBT turn on gate resistor
 $di_f/dt, di_{rr}/dt = f(R_{gon})$

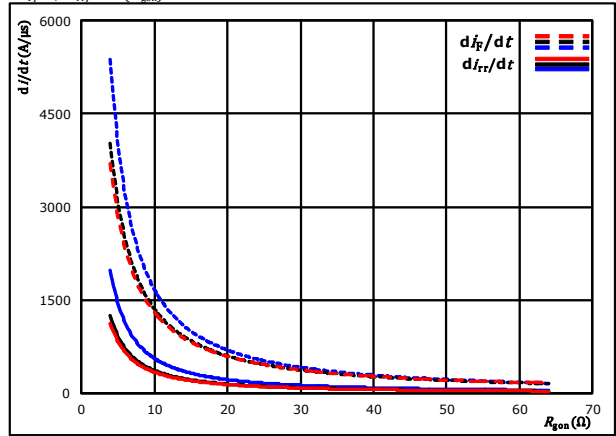

At $V_{CE} = 600$ V $T_j = 25$ °C
 $V_{GE} = \pm 15$ V $T_j = 125$ °C
 $I_c = 25$ A $T_j = 150$ °C

figure 15. IGBT

Reverse bias safe operating area
 $I_c = f(V_{CE})$

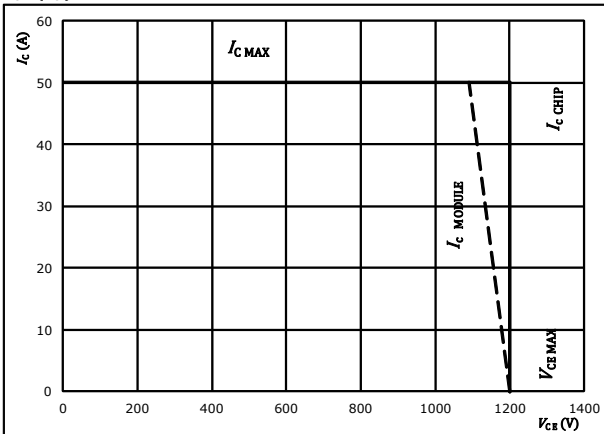

At $T_j = 125$ °C
 $R_{gon} = 16$ Ω
 $R_{goff} = 16$ Ω



Vincotech

Inverter Switching Definitions

General conditions

T_j	=	125 °C
R_{gon}	=	16 Ω
R_{goff}	=	16 Ω

figure 1. IGBT

Turn-off Switching Waveforms & definition of t_{doff} , t_{Eoff} (t_{Eoff} = integrating time for E_{off})

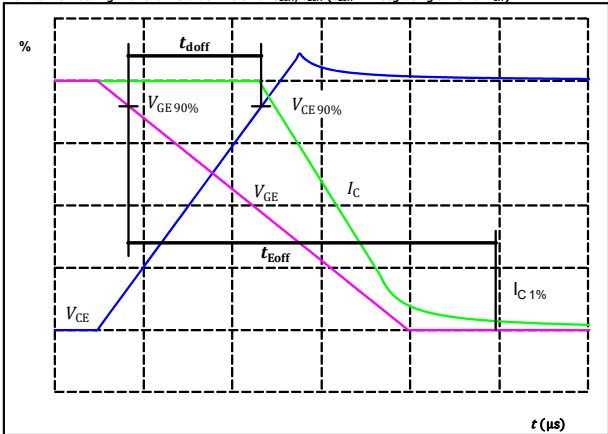

$V_{CE}(0\%) =$	-15	V
$V_{GE}(100\%) =$	15	V
$V_C(100\%) =$	600	V
$I_C(100\%) =$	25	A
$t_{doff} =$	191	ns

figure 2. IGBT

Turn-on Switching Waveforms & definition of t_{don} , t_{Eon} (t_{Eon} = integrating time for E_{on})

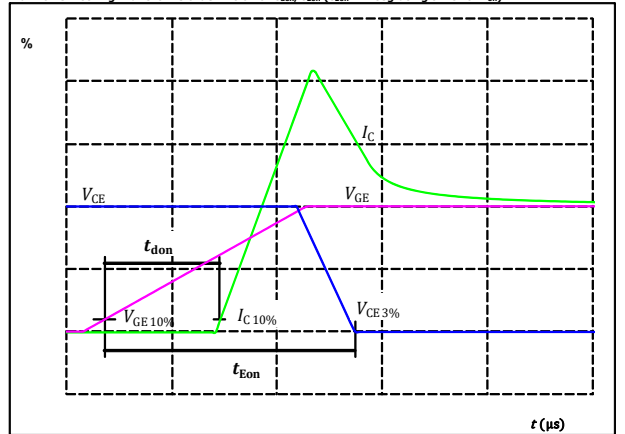

$V_{CE}(0\%) =$	-15	V
$V_{GE}(100\%) =$	15	V
$V_C(100\%) =$	600	V
$I_C(100\%) =$	25	A
$t_{don} =$	149	ns

figure 3. IGBT

Turn-off Switching Waveforms & definition of t_f

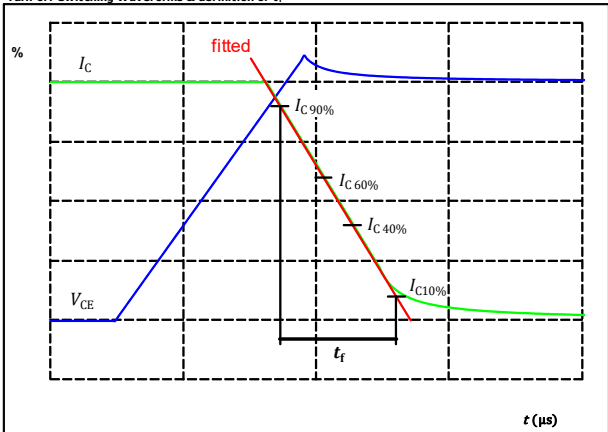

$V_C(100\%) =$	600	V
$I_C(100\%) =$	25	A
$t_f =$	110	ns

figure 4. IGBT

Turn-on Switching Waveforms & definition of t_r

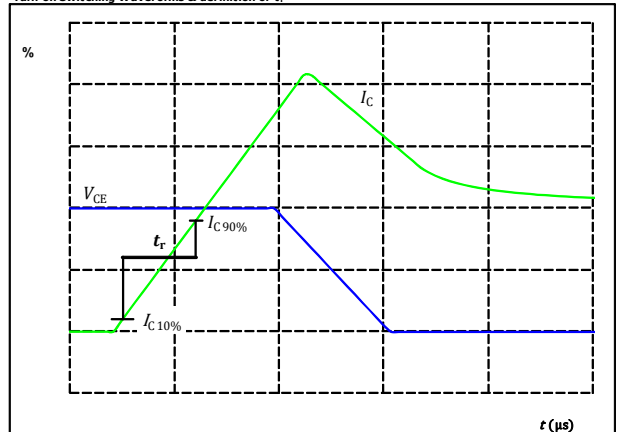

$V_C(100\%) =$	600	V
$I_C(100\%) =$	25	A
$t_r =$	33	ns



Vincotech

Inverter Switching Characteristics

figure 5. FWD

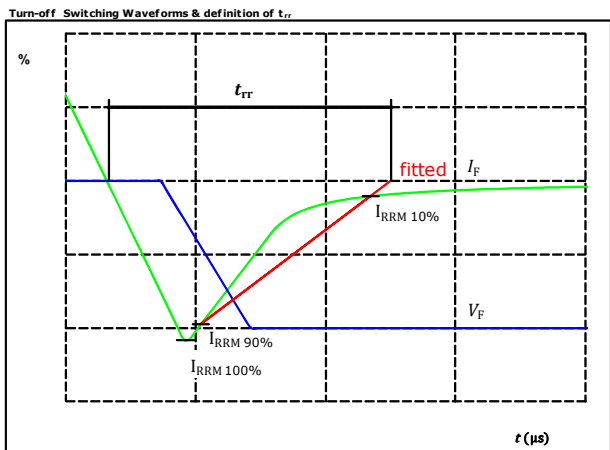

V_F (100%) =	600	V
I_F (100%) =	25	A
I_{RRM} (100%) =	23	A
t_{rr} =	367	ns

figure 6. FWD

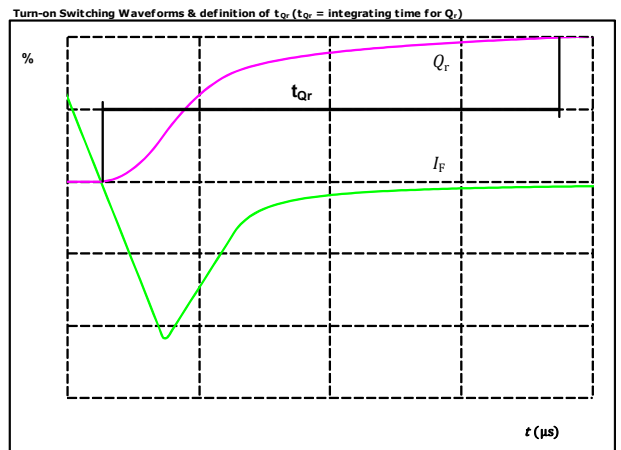

I_F (100%) =	25	A
Q_r (100%) =	3,88	μ C



Vincotech

10-EZ126PA025M7-L858F78T
10-E1126PA025M7-L858F78Z
 datasheet

Ordering Code & Marking								
Version			Ordering Code					
without thermal paste 12 mm housing with Press-fit pins			10-EZ126PA025M7-L858F78T					
without thermal paste 12 mm housing with solder pins			10-E1126PA025M7-L858F78Z					
with thermal paste 12 mm housing with Press-fit pins			10-EZ126PA025M7-L858F78T-/3/					
with thermal paste 12 mm housing with solder pins			10-E1126PA025M7-L858F78Z-/3/					
NN-NNNNNNNNNNNN TTTTWWWWYY UL VIN LLLL SSSS			Text	Name	Date code	UL & VIN	Lot	Serial
				NN-NNNNNNNNNNNN-TTTTWW	WWYY	UL VIN	LLLL	SSSS
			Datamatrix	Type&Ver	Lot number	Serial	Date code	
			TTTTTWW	LLLL	SSSS	WWYY		

Pin table				Solder pin	
Pin	X	Y	Function		
1	12,8	9,6	DC+		
2	16	9,6	DC+		
3	22,4	9,6	Therm1		
4	25,6	9,6	Therm2		
5	32	9,6	DC-2		
6	32	6,4	S13		
7	32	3,2	DC-1		
8	32	0	S11		
9	28,8	0	G11		
10	6,4	0	Ph1		
11	3,2	0	Ph1		
12	0	0	G12		
13	0	6,4	G14		
14	0	16	Ph2		
15	0	19,2	Ph2		
16	0	25,6	G16		
17	3,2	25,6	Ph3		
18	6,4	25,6	Ph3		
19	28,8	25,6	G15		
20	32	25,6	S15		
21	32	22,4	DC-3		
22	32	16	G13		

center of press-fit pinhead
for connection parameter see the handling instruction

Tolerance of pinpositions: ±0.4mm at the end of pins
Dimension of coordinate axis is only offset without tolerance



Vincotech

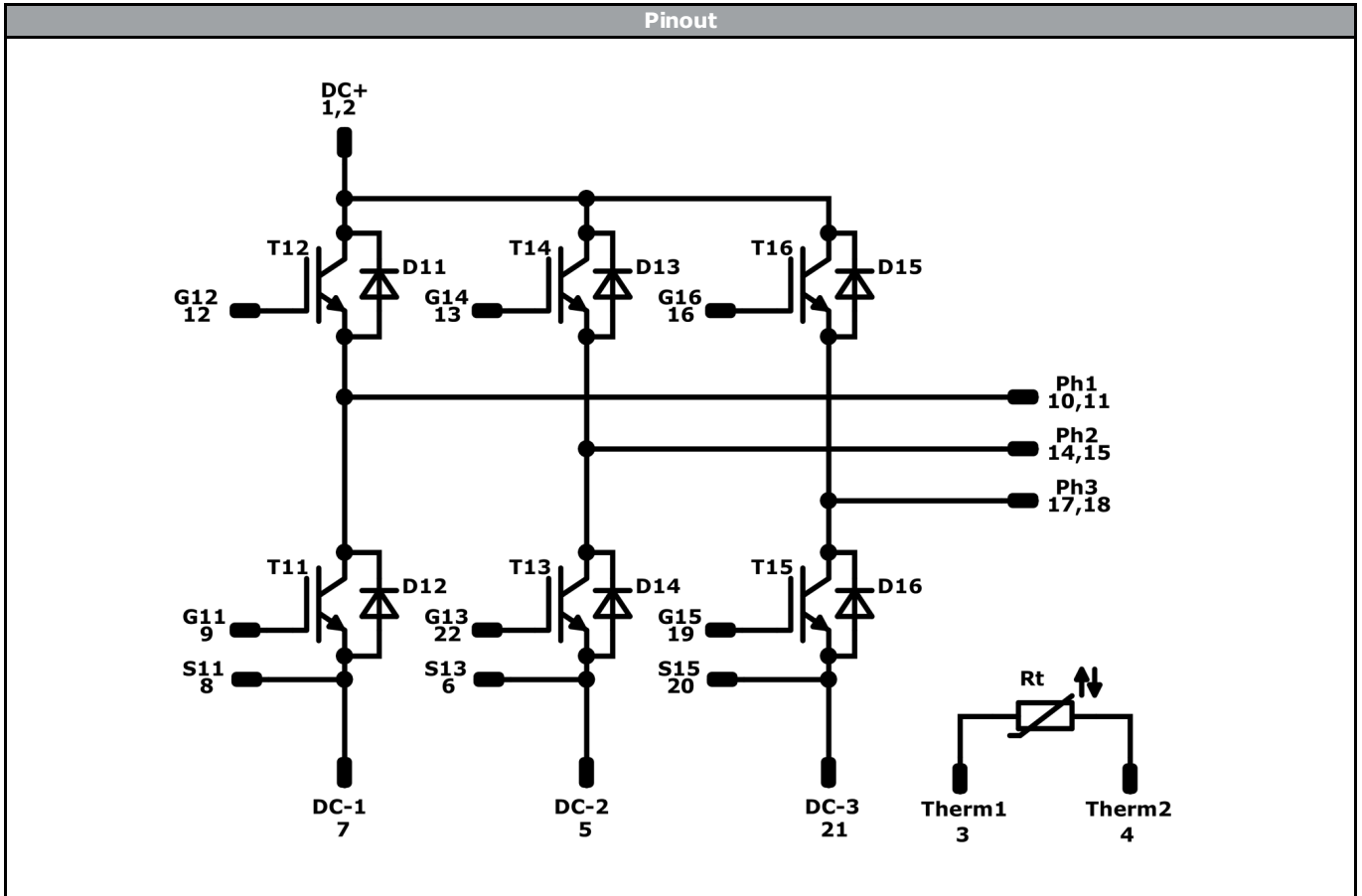

Identification					
ID	Component	Voltage	Current	Function	Comment
T11, T12, T13, T14, T15, T16	IGBT	1200 V	25 A	Inverter Switch	
D11, D12, D13, D14, D15, D16	FWD	1200 V	25 A	Inverter Diode	
Rt	NTC			Thermistor	



Vincotech

10-EZ126PA025M7-L858F78T
10-E1126PA025M7-L858F78Z
datasheet

Packaging instruction			
Standard packaging quantity (SPQ) 100	>SPQ	Standard	<SPQ Sample

Handling instruction
Handling instructions for <i>flow</i> E1 packages see vincotech.com website.

Package data
Package data for <i>flow</i> E1 packages see vincotech.com website.

UL recognition and file number
This device is certified according to UL 1557 standard, UL file number E192116. For more information see vincotech.com website. 

Document No.:	Date:	Modification:	Pages
10-Ex126PA025M7-L858F78x-D4-14	30 May. 2019	Correction of I_c/I_f values Outline updated	1,2 14

DISCLAIMER

The information, specifications, procedures, methods and recommendations herein (together "information") are presented by Vincotech to reader in good faith, are believed to be accurate and reliable, but may well be incomplete and/or not applicable to all conditions or situations that may exist or occur. Vincotech reserves the right to make any changes without further notice to any products to improve reliability, function or design. No representation, guarantee or warranty is made to reader as to the accuracy, reliability or completeness of said information or that the application or use of any of the same will avoid hazards, accidents, losses, damages or injury of any kind to persons or property or that the same will not infringe third parties rights or give desired results. It is reader's sole responsibility to test and determine the suitability of the information and the product for reader's intended use.

LIFE SUPPORT POLICY

Vincotech products are not authorised for use as critical components in life support devices or systems without the express written approval of Vincotech.

As used herein:

1. Life support devices or systems are devices or systems which, (a) are intended for surgical implant into the body, or (b) support or sustain life, or (c) whose failure to perform when properly used in accordance with instructions for use provided in labelling can be reasonably expected to result in significant injury to the user.
2. A critical component is any component of a life support device or system whose failure to perform can be reasonably expected to cause the failure of the life support device or system, or to affect its safety or effectiveness.

单击下面可查看定价，库存，交付和生命周期等信息

[>>Vincotech\(威科\)](#)