



<i>flow</i> PIM 0	600 V / 15 A
<div style="border: 1px solid black; padding: 5px; margin-bottom: 5px;"> <p style="text-align: center; margin: 0;">Features</p> <ul style="list-style-type: none"> Vincotech clip-in housing Trench Fieldstop IGBT's for low saturation losses Optional w/o BRC </div> <div style="border: 1px solid black; padding: 5px; margin-bottom: 5px;"> <p style="text-align: center; margin: 0;">Target Applications</p> <ul style="list-style-type: none"> Industrial drives Embedded drives </div> <div style="border: 1px solid black; padding: 5px;"> <p style="text-align: center; margin: 0;">Types</p> <ul style="list-style-type: none"> V23990-P544-A28-PM V23990-P544-A29-PM V23990-P544-B28-PM V23990-P544-B128-PM V23990-P544-B129-PM V23990-P544-C29-PM V23990-P544-C28-PM </div>	<div style="border: 1px solid black; padding: 5px; margin-bottom: 5px;"> <p style="text-align: center; margin: 0;">flow0 housing</p> <div style="display: flex; justify-content: space-around; align-items: center;"> </div> <div style="display: flex; justify-content: space-around; margin-top: 5px;"> 12 mm housing 17 mm housing </div> </div> <div style="border: 1px solid black; padding: 5px;"> <p style="text-align: center; margin: 0;">Schematic</p> </div>

Maximum Ratings

$T_j = 25\text{ }^\circ\text{C}$, unless otherwise specified

Parameter	Symbol	Condition	Value	Unit
Rectifier Diode				
Repetitive peak reverse voltage	V_{RRM}		1600	V
DC forward current	I_{FAV}	$T_j = T_{jmax}$ $T_s = 80\text{ }^\circ\text{C}$	35	A
Surge (non-repetitive) forward current	I_{FSM}	$t_p = 10\text{ ms}$	200	A
I^2t -value	I^2t	50 Hz half sine wave $T_j = 150\text{ }^\circ\text{C}$	200	A^2s
Power dissipation	P_{tot}	$T_j = T_{jmax}$ $T_s = 80\text{ }^\circ\text{C}$	46	W
Maximum Junction Temperature	T_{jmax}		150	$^\circ\text{C}$
Inverter Switch				
Collector-emitter break down voltage	V_{CE}		600	V
DC collector current	I_C	$T_j = T_{jmax}$ $T_s = 80\text{ }^\circ\text{C}$	21	A
Repetitive peak collector current	I_{CRM}	t_p limited by T_{jmax}	45	A
Turn off safe operating area		$V_{CE} \leq 1200\text{V}$, $T_j \leq T_{op\text{ max}}$	45	A
Power dissipation	P_{tot}	$T_j = T_{jmax}$ $T_s = 80\text{ }^\circ\text{C}$	51	W
Gate-emitter peak voltage	V_{GE}		± 20	V
Short circuit ratings	t_{SC} V_{CC}	$T_j \leq 150\text{ }^\circ\text{C}$ $V_{GE} = 15\text{ V}$	6 360	μs V
Maximum Junction Temperature	T_{jmax}		175	$^\circ\text{C}$



Maximum Ratings

 $T_j = 25\text{ °C}$, unless otherwise specified

Parameter	Symbol	Condition	Value	Unit
-----------	--------	-----------	-------	------

Inverter Diode

Peak Repetitive Reverse Voltage	V_{RRM}		600	V
DC forward current	I_F	$T_j = T_{jmax}$ $T_s = 80\text{ °C}$	21	A
Repetitive peak forward current	I_{FRM}	t_p limited by T_{jmax}	30	A
Power dissipation	P_{tot}	$T_j = T_{jmax}$ $T_s = 80\text{ °C}$	44	W
Maximum Junction Temperature	T_{jmax}		175	°C

Brake Switch

Collector-emitter break down voltage	V_{CE}		600	V
DC collector current	I_C	$T_j = T_{jmax}$ $T_s = 80\text{ °C}$	14	A
Repetitive peak collector current	I_{CRM}	t_p limited by T_{jmax}	30	A
Turn off safe operating area		$V_{CE} \leq 1200V$, $T_j \leq T_{op, max}$	30	A
Power dissipation	P_{tot}	$T_j = T_{jmax}$ $T_s = 80\text{ °C}$	44	W
Gate-emitter peak voltage	V_{GE}		± 20	V
Short circuit ratings	t_{SC} V_{CC}	$T_j \leq 150\text{ °C}$ $V_{GE} = 15\text{ V}$	6 360	μs V
Maximum Junction Temperature	T_{jmax}		175	°C

Brake Diode

Peak Repetitive Reverse Voltage	V_{RRM}		600	V
DC forward current	I_F	$T_j = T_{jmax}$ $T_s = 80\text{ °C}$	14	A
Repetitive peak forward current	I_{FRM}	t_p limited by T_{jmax}	20	A
Power dissipation	P_{tot}	$T_j = T_{jmax}$ $T_s = 80\text{ °C}$	32	W
Maximum Junction Temperature	T_{jmax}		175	°C

Thermal Properties

Storage temperature	T_{stg}		-40...+125	°C
Operation temperature under switching condition	T_{op}		-40...+($T_{jmax} - 25$)	°C

Isolation Properties

Isolation voltage	V_{isol}	$t = 2\text{ s}$ DC voltage	4000	V
Creepage distance			min 12,7	mm
Clearance		12 mm / 17 mm housing	9,7 / min 12,7	mm
Comparative tracking index	CTI		>200	



Characteristic Values

Parameter	Symbol	Conditions					Value			Unit
		V_{GE} [V] V_{GS} [V]	V_r [V] V_{CE} [V] V_{DS} [V]	I_C [A] I_F [A] I_D [A]	T_j [°C]	Min	Typ	Max		

Rectifier Diode

Forward voltage	V_F				25	25 125	0,8	1,26 1,24	1,45	V
Threshold voltage (for power loss calc. only)	V_{to}				25	25 125		0,92 0,82		V
Slope resistance (for power loss calc. only)	r_t				25	25 125		11 14		mΩ
Reverse current	I_r			1600		25 145			0,05 1,1	mA
Thermal resistance junction to sink	$R_{th(j-s)}$	phase-change material $\lambda = 3,4$ W/mK						1,61		K/W

Inverter Switch

Gate emitter threshold voltage	$V_{GE(th)}$	$V_{CE} = V_{GE}$			0,00021	25		5	5,8	6,5	V
Collector-emitter saturation voltage	V_{CEsat}		15		15	25 150	1,1	1,61 1,81	1,9		V
Collector-emitter cut-off current incl. Diode	I_{CES}		0	600		25			0,00085		mA
Gate-emitter leakage current	I_{GES}		20	0		25			300		nA
Integrated Gate resistor	R_{gint}							none			Ω
Turn-on delay time	$t_{d(on)}$	$R_{gon} = 8 \Omega$ $R_{goff} = 16 \Omega$	+15/0	300	15	25		14		ns	
Rise time	t_r					150		13			
Turn-off delay time	$t_{d(off)}$					25		127			
Fall time	t_f					150		146			
Turn-on energy loss	E_{on}					25		0,19			
Turn-off energy loss	E_{off}	150		0,26							
Input capacitance	C_{ies}	$f = 1$ MHz	0	25	25			860		pF	
Output capacitance	C_{oss}							55			
Reverse transfer capacitance	C_{rss}							24			
Gate charge	Q_G		15	480	15	25		87		nC	
Thermal resistance junction to sink	$R_{th(j-s)}$	phase-change material $\lambda = 3,4$ W/mK						1,88		K/W	

Inverter Diode

Diode forward voltage	V_F				15	25 150	1,25	1,79 1,67	1,95	V
Peak reverse recovery current	I_{RRM}	$R_{gon} = 16 \Omega$	+15/0	300	15	25		15		A
Reverse recovery time	t_{rr}					150		17		
Reverse recovered charge	Q_{rr}					25		100		
Peak rate of fall of recovery current	$(di_{rr}/dt)_{max}$					150		184		
Reverse recovered energy	E_{rec}					25		0,52		
Thermal resistance junction to sink	$R_{th(j-s)}$	phase-change material $\lambda = 3,4$ W/mK						2,67		K/W



Characteristic Values

Parameter	Symbol	Conditions					Value			Unit	
		V_{GE} [V]	V_{GS} [V]	V_r [V]	V_{CE} [V]	V_{DS} [V]	I_C [A]	I_F [A]	I_D [A]		T_j [°C]

Brake Switch

Gate emitter threshold voltage	$V_{GE(th)}$	$V_{CE} = V_{GE}$				0,00015	25	5	5,8	6,5	V
Collector-emitter saturation voltage	$V_{CE(sat)}$		15			10	25 150	1,1	1,66 1,87	1,9	V
Collector-emitter cut-off incl diode	I_{CES}		0	600			25			0,0006	mA
Gate-emitter leakage current	I_{GES}		20	0			25			300	nA
Integrated Gate resistor	R_{gint}								none		Ω
Turn-on delay time	$t_{d(on)}$	$R_{goff} = 16 \Omega$ $R_{gon} = 32 \Omega$	+15/0	300	10		25		15		ns
Rise time	t_r						150		15		
Turn-off delay time	$t_{d(off)}$						25		11		
Fall time	t_f						150		14		
Turn-on energy loss	E_{on}						25		147		
Turn-off energy loss	E_{off}						150		163		
Input capacitance	C_{ies}	$f = 1 \text{ MHz}$	0	25		25			551		pF
Output capacitance	C_{oss}								40		
Reverse transfer capacitance	C_{rss}								17		
Gate charge	Q_G		15	480	10	25			62		nC
Thermal resistance junction to sink	$R_{th(j-s)}$	phase-change material $\lambda = 3,4 \text{ W/mK}$							2,18		K/W

Brake Diode

Diode forward voltage	V_F					10	25 150	1,25	1,67 1,61	1,95	V
Reverse leakage current	I_r			600			25			27	μA
Peak reverse recovery current	I_{RRM}	$R_{goff} = 32 \Omega$	+15/0	300	10		25		10		A
Reverse recovery time	t_{rr}						150		10		
Reverse recovered charge	Q_{rr}						25		149		
Peak rate of fall of recovery current	$(di_{rr}/dt)_{max}$						150		208		
Reverse recovery energy	E_{rec}						25		0,46		
							150		0,46		
Thermal resistance junction to sink	$R_{th(j-s)}$	phase-change material $\lambda = 3,4 \text{ W/mK}$							2,95		K/W

Thermistor

Rated resistance	R						25		22000		Ω
Deviation of R100	$\Delta_{R/R}$	$R_{100} = 1484 \Omega$					100	-5		5	%
Power dissipation	P						25		210		mW
Power dissipation constant							25		3,5		mW/K
B-value	$B_{(25/50)}$	Tol. $\pm 3\%$					25				K
B-value	$B_{(25/100)}$	Tol. $\pm 3\%$					25		4000		K
Vincotech NTC Reference							25			A	



Inverter Characteristics

Figure 1 IGBT
Typical output characteristics

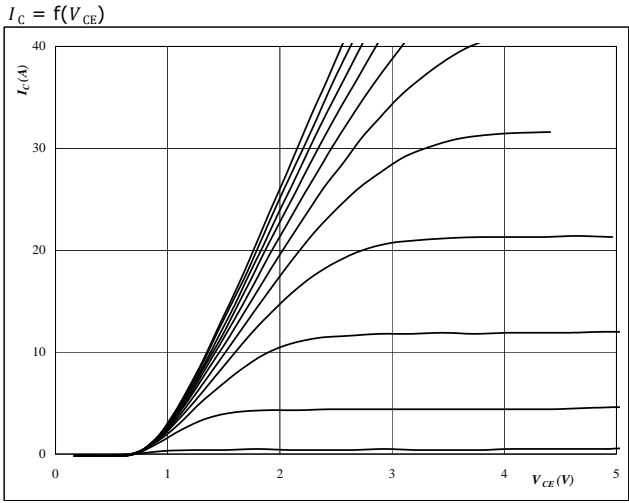

At
 $t_p = 250 \mu s$
 $T_j = 25 \text{ } ^\circ C$
 V_{GE} from 7 V to 17 V in steps of 1 V

Figure 2 IGBT
Typical output characteristics

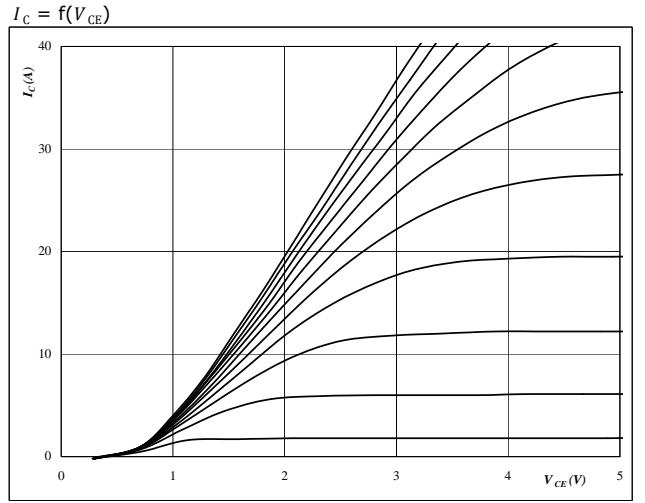

At
 $t_p = 250 \mu s$
 $T_j = 125 \text{ } ^\circ C$
 V_{GE} from 7 V to 17 V in steps of 1 V

Figure 3 IGBT
Typical transfer characteristics

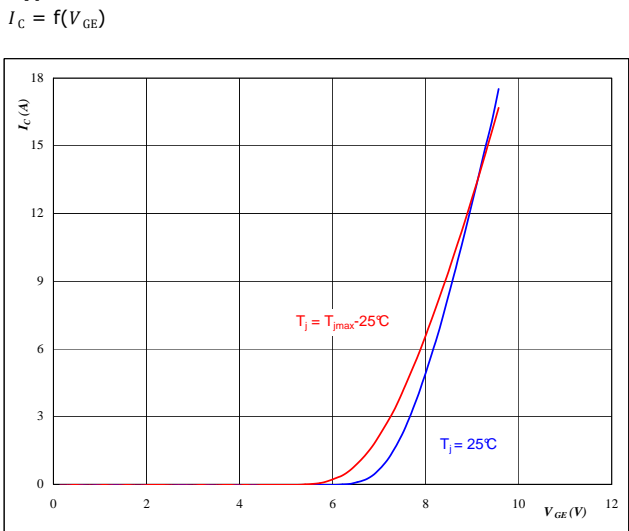

At
 $t_p = 250 \mu s$
 $V_{CE} = 10 V$

Figure 4 FWD
Typical diode forward current as a function of forward voltage

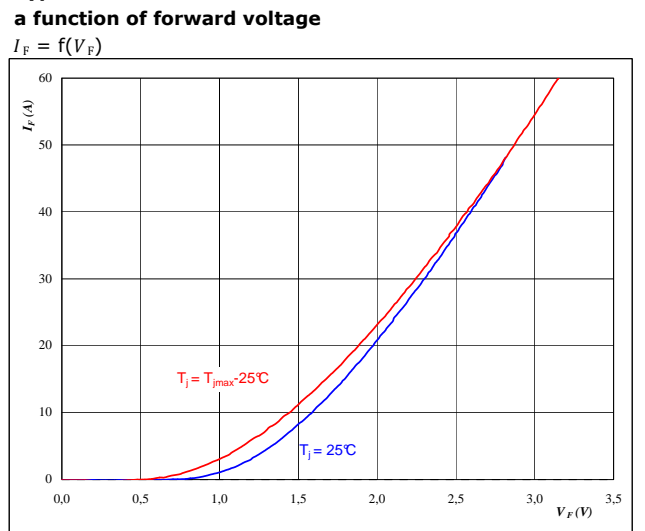

At
 $t_p = 250 \mu s$



Inverter Characteristics

Figure 5 IGBT

Typical switching energy losses
as a function of collector current

$E = f(I_C)$

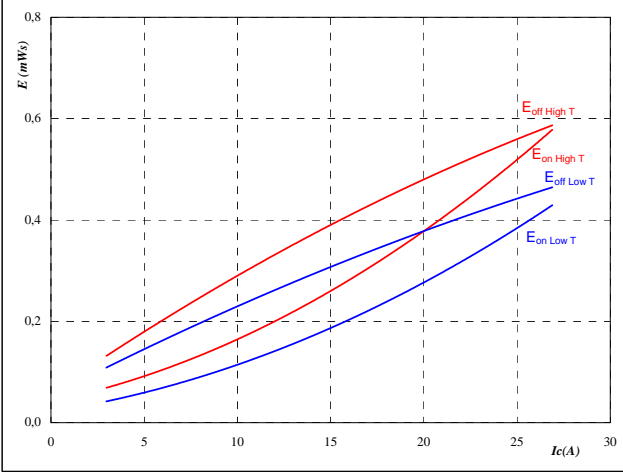

With an inductive load at
 $T_j = 25/125$ °C
 $V_{CE} = 300$ V
 $V_{GE} = 15$ V
 $R_{gon} = 16$ Ω
 $R_{goff} = 8$ Ω

Figure 6 IGBT

Typical switching energy losses
as a function of gate resistor

$E = f(R_G)$

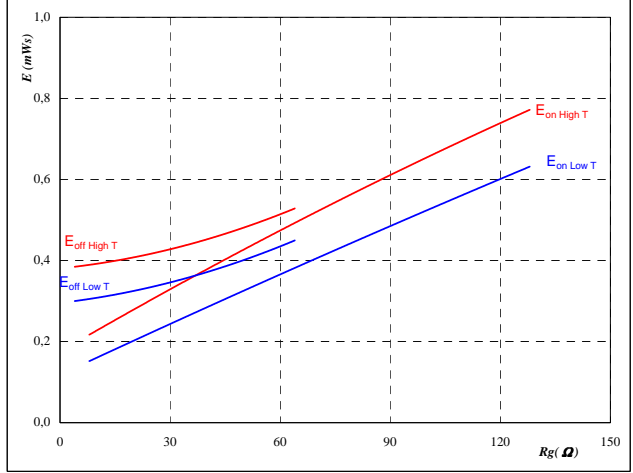

With an inductive load at
 $T_j = 25/125$ °C
 $V_{CE} = 300$ V
 $V_{GE} = 15$ V
 $I_C = 15$ A

Figure 7 FWD

Typical reverse recovery energy loss
as a function of collector current

$E_{rec} = f(I_C)$

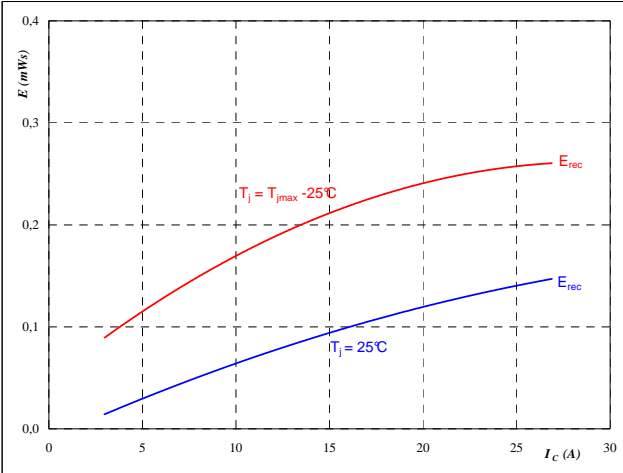

With an inductive load at
 $T_j = 25/125$ °C
 $V_{CE} = 300$ V
 $V_{GE} = 15$ V
 $R_{gon} = 16$ Ω

Figure 8 FWD

Typical reverse recovery energy loss
as a function of gate resistor

$E_{rec} = f(R_G)$

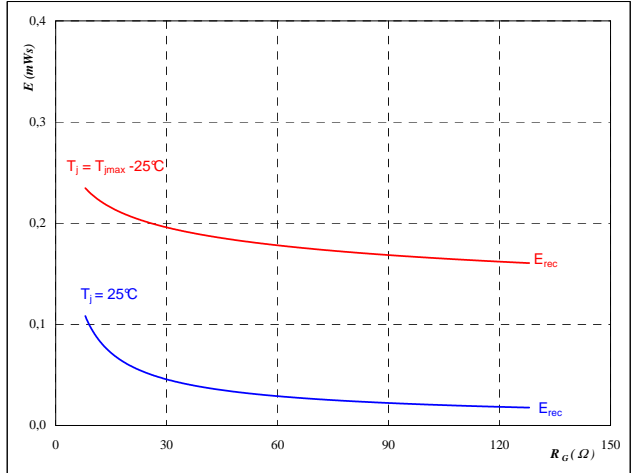

With an inductive load at
 $T_j = 25/125$ °C
 $V_{CE} = 300$ V
 $V_{GE} = 15$ V
 $I_C = 15$ A



Inverter Characteristics

Figure 9 IGBT

Typical switching times as a function of collector current

$t = f(I_C)$

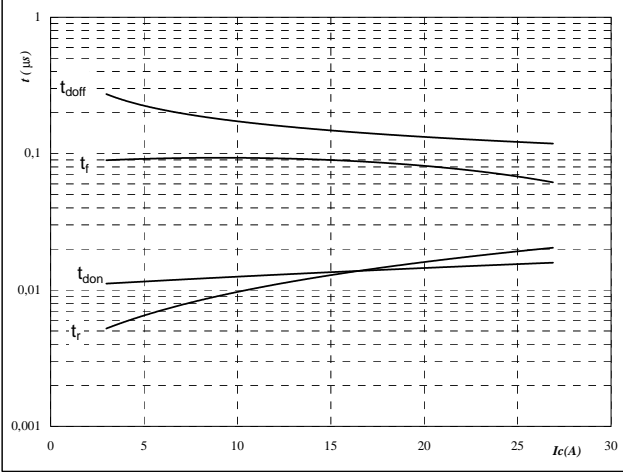

With an inductive load at
 $T_j = 125$ °C
 $V_{CE} = 300$ V
 $V_{GE} = 15$ V
 $R_{gon} = 16$ Ω
 $R_{goff} = 8$ Ω

Figure 10 IGBT

Typical switching times as a function of gate resistor

$t = f(R_G)$

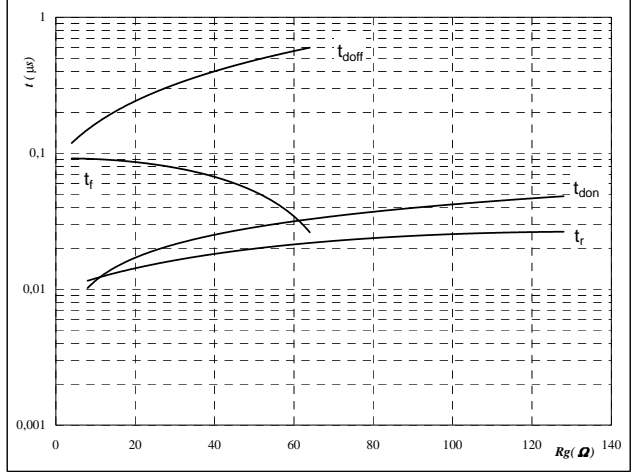

With an inductive load at
 $T_j = 125$ °C
 $V_{CE} = 300$ V
 $V_{GE} = 15$ V
 $I_C = 15$ A

Figure 11 FWD

Typical reverse recovery time as a function of collector current

$t_{rr} = f(I_C)$

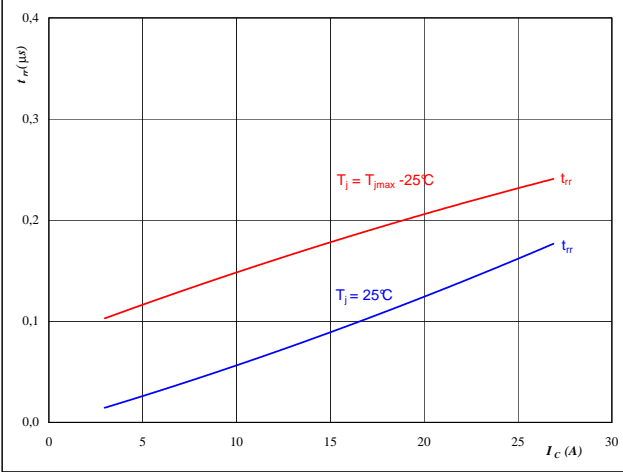

At
 $T_j = 25/125$ °C
 $V_{CE} = 300$ V
 $V_{GE} = 15$ V
 $R_{gon} = 16$ Ω

Figure 12 FWD

Typical reverse recovery time as a function of IGBT turn on gate resistor

$t_{rr} = f(R_{gon})$

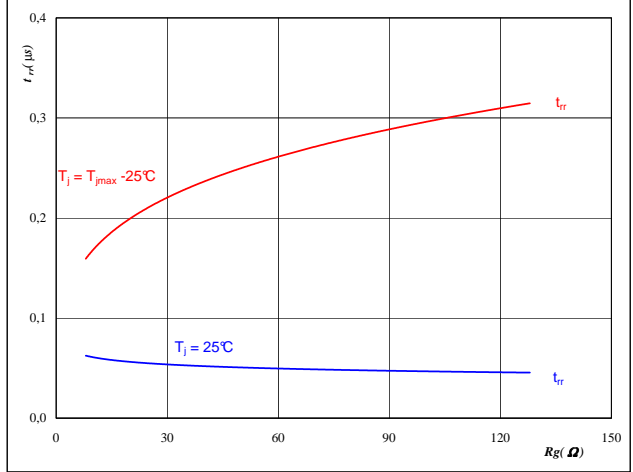

At
 $T_j = 25/125$ °C
 $V_R = 300$ V
 $I_F = 15$ A
 $V_{GE} = 15$ V



Inverter Characteristics

Figure 13 FWD

Typical reverse recovery charge as a function of collector current

$$Q_{rr} = f(I_c)$$

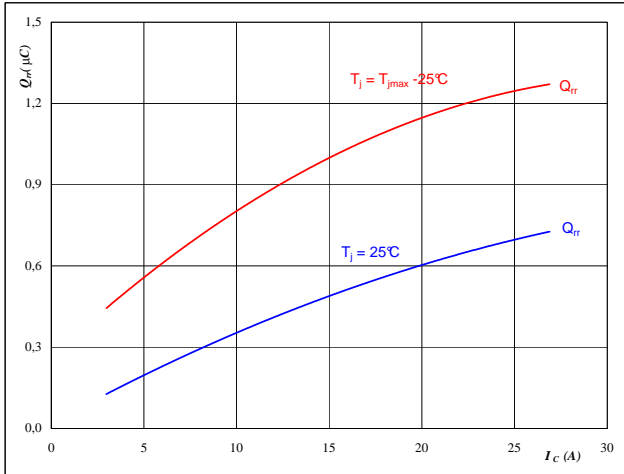

At
 $T_j = 25/125$ °C
 $V_{CE} = 300$ V
 $V_{GE} = 15$ V
 $R_{gon} = 16$ Ω

Figure 14 FWD

Typical reverse recovery charge as a function of IGBT turn on gate resistor

$$Q_{rr} = f(R_{gon})$$

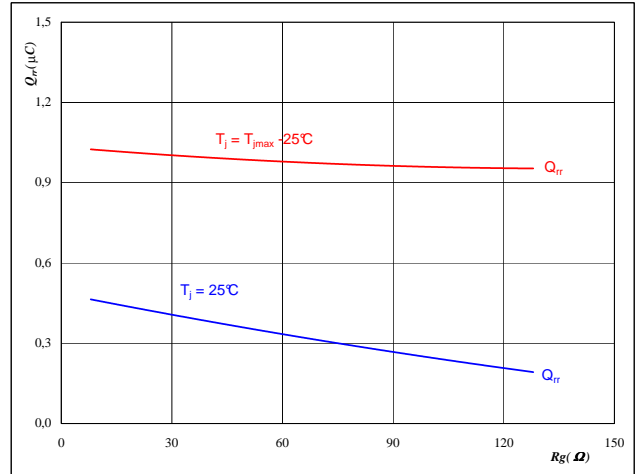

At
 $T_j = 25/125$ °C
 $V_R = 300$ V
 $I_F = 15$ A
 $V_{GE} = 15$ V

Figure 15 FWD

Typical reverse recovery current as a function of collector current

$$I_{RRM} = f(I_c)$$

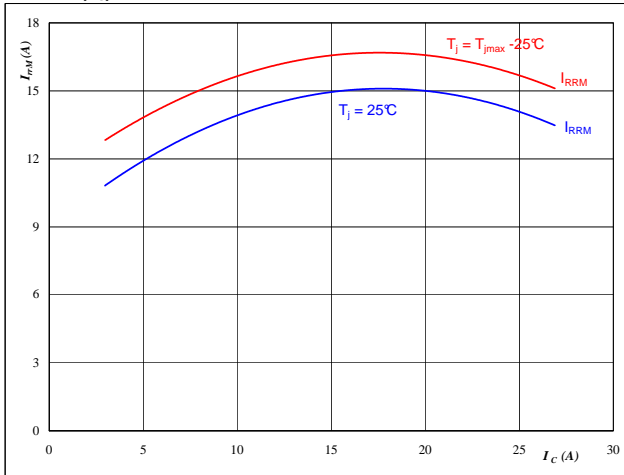

At
 $T_j = 25/125$ °C
 $V_{CE} = 300$ V
 $V_{GE} = 15$ V
 $R_{gon} = 16$ Ω

Figure 16 FWD

Typical reverse recovery current as a function of IGBT turn on gate resistor

$$I_{RRM} = f(R_{gon})$$

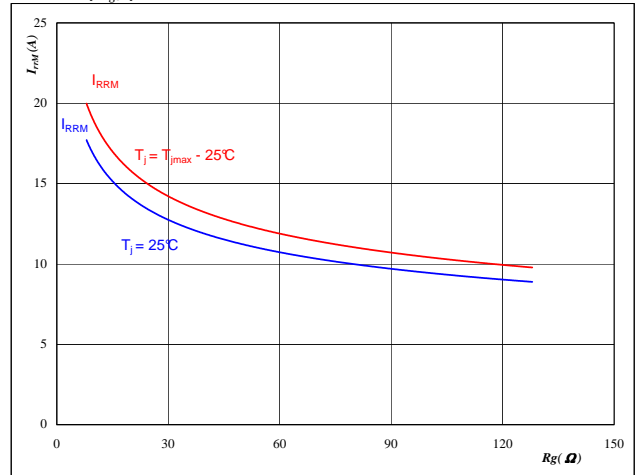

At
 $T_j = 25/125$ °C
 $V_R = 300$ V
 $I_F = 15$ A
 $V_{GE} = 15$ V



Inverter Characteristics

Figure 17 FWD

Typical rate of fall of forward and reverse recovery current as a function of collector current

$$dI_0/dt, dI_{rec}/dt = f(I_C)$$

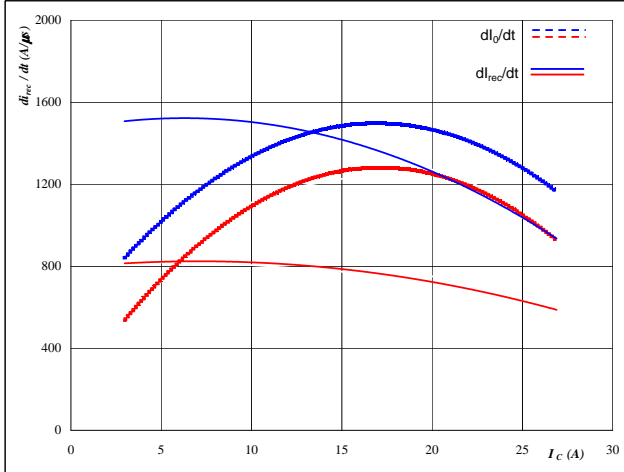

At
 $T_j = 25/125$ °C
 $V_{CE} = 300$ V
 $V_{GE} = 15$ V
 $R_{gon} = 16$ Ω

Figure 18 FWD

Typical rate of fall of forward and reverse recovery current as a function of IGBT turn on gate resistor

$$dI_0/dt, dI_{rec}/dt = f(R_{gon})$$

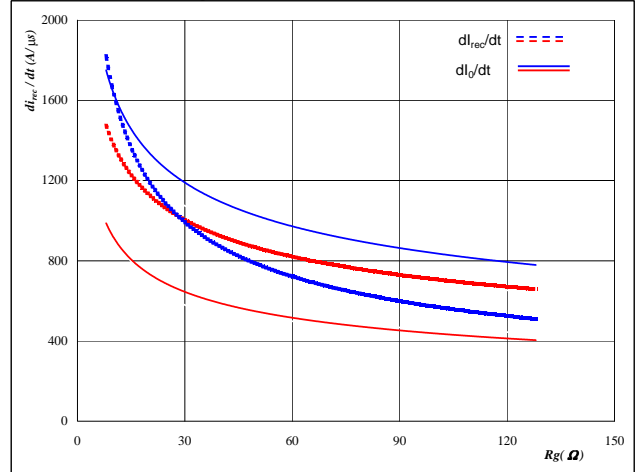

At
 $T_j = 25/125$ °C
 $V_R = 300$ V
 $I_F = 15$ A
 $V_{GE} = 15$ V

Figure 19 IGBT

IGBT transient thermal impedance as a function of pulse width

$$Z_{th(j-s)} = f(t_p)$$

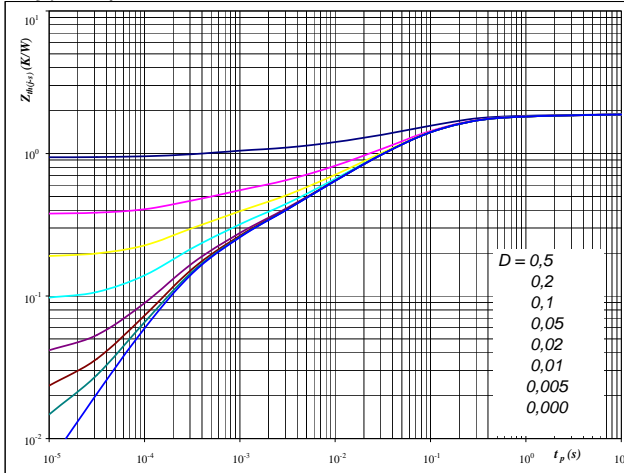

At
 $D = t_p / T$
 $R_{th(j-s)} = 1,88$ K/W

IGBT thermal model values

R (K/W)	Tau (s)
6,56E-02	3,42E+00
2,26E-01	3,66E-01
8,74E-01	7,63E-02
3,72E-01	1,39E-02
1,73E-01	2,53E-03
1,70E-01	2,96E-04

Figure 20 FWD

FWD transient thermal impedance as a function of pulse width

$$Z_{th(j-s)} = f(t_p)$$

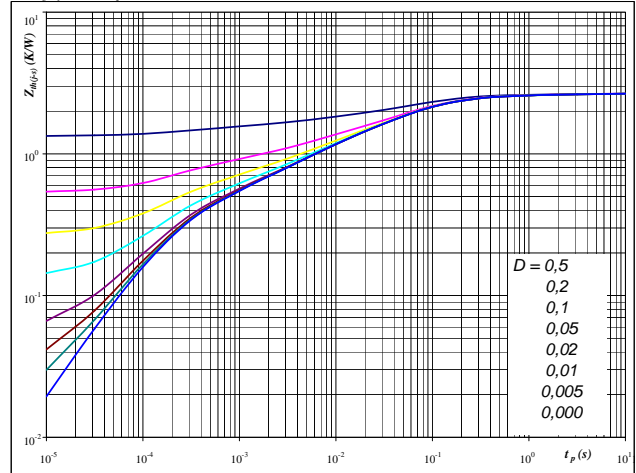

At
 $D = t_p / T$
 $R_{th(j-s)} = 2,67$ K/W

FWD thermal model values

R (K/W)	Tau (s)
5,08E-02	8,17E+00
1,65E-01	7,39E-01
7,58E-01	1,07E-01
7,19E-01	3,13E-02
4,65E-01	5,42E-03
2,28E-01	8,46E-04
2,82E-01	1,76E-04



Inverter Characteristics

Figure 21 IGBT

Power dissipation as a function of heatsink temperature

$$P_{tot} = f(T_s)$$

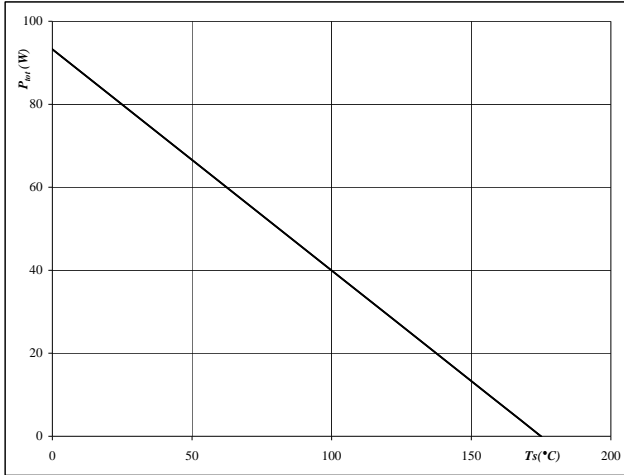

At
T_j = 175 °C

Figure 22 IGBT

Collector current as a function of heatsink temperature

$$I_C = f(T_s)$$

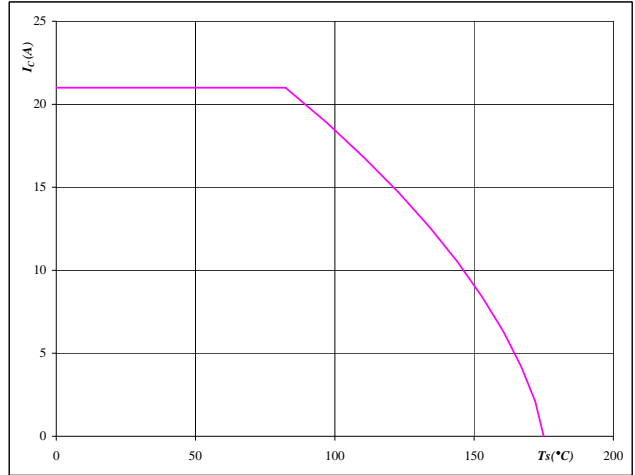

At
T_j = 175 °C
V_{GE} = 15 V

Figure 23 FWD

Power dissipation as a function of heatsink temperature

$$P_{tot} = f(T_s)$$

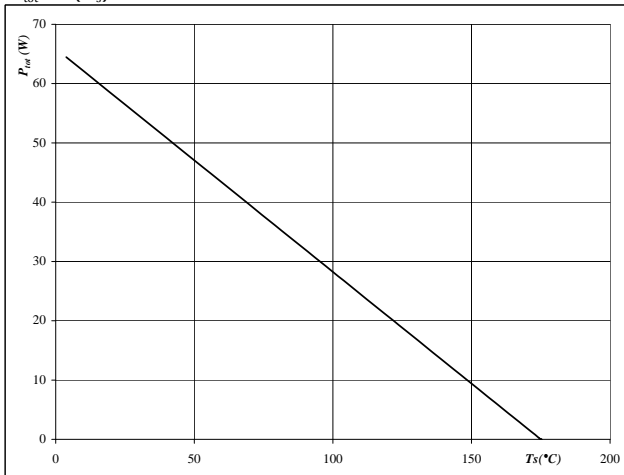

At
T_j = 175 °C

Figure 24 FWD

Forward current as a function of heatsink temperature

$$I_F = f(T_s)$$

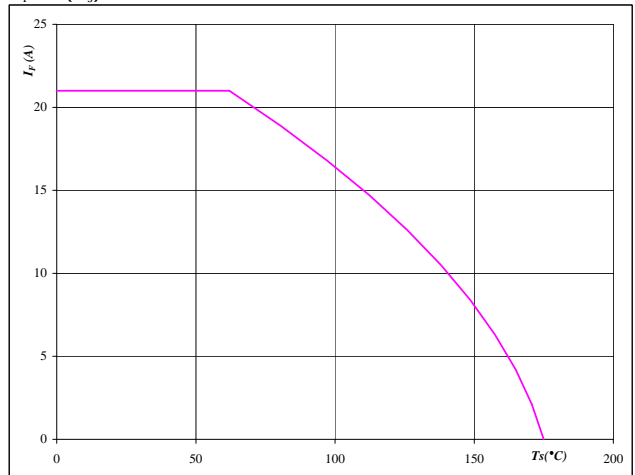

At
T_j = 175 °C



Inverter Characteristics

Figure 25 IGBT

Safe operating area as a function of collector-emitter voltage

$I_C = f(V_{CE})$

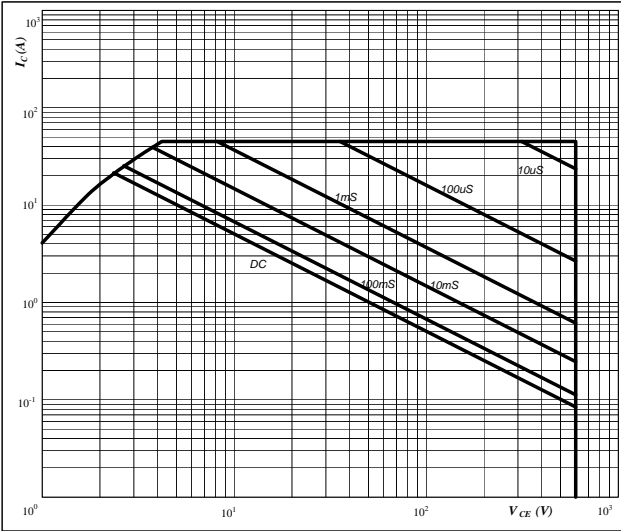

At
 $D =$ single pulse
 $T_s = 80$ °C
 $V_{GE} = 15$ V
 $T_j = T_{jmax}$ °C

Figure 26 IGBT

Gate voltage vs Gate charge

$V_{GE} = f(Q_g)$

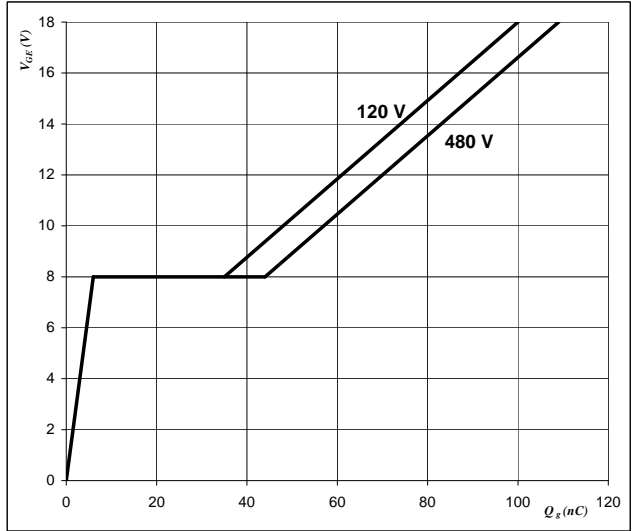

At
 $I_C = 15$ A

Figure 27 IGBT

Short circuit withstand time as a function of gate-emitter voltage

$t_{sc} = f(V_{GE})$

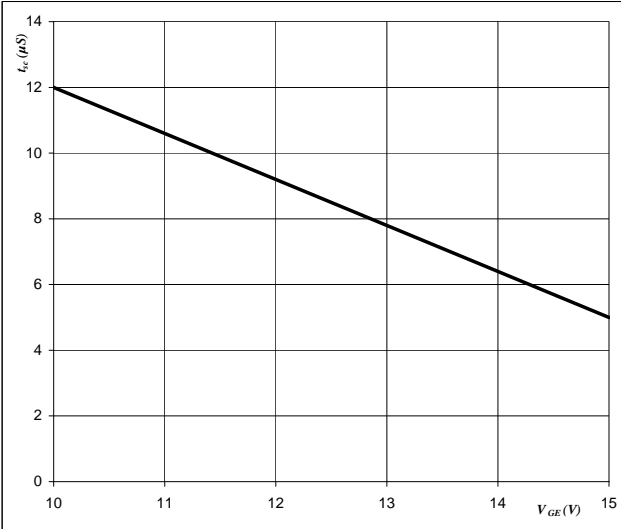

At
 $V_{CE} = 600$ V
 $T_j \leq 175$ °C

Figure 28 IGBT

Typical short circuit collector current as a function of gate-emitter voltage

$I_{SC} = f(V_{GE})$

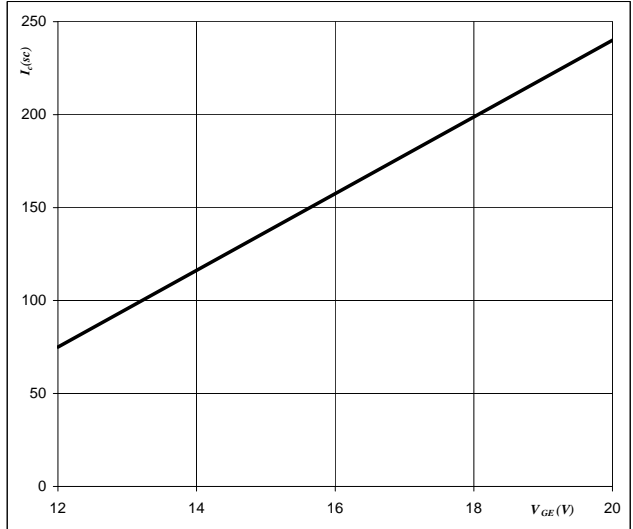

At
 $V_{CE} \leq 600$ V
 $T_j = 175$ °C



Inverter Characteristics

Figure 29 IGBT
Reverse bias safe operating area

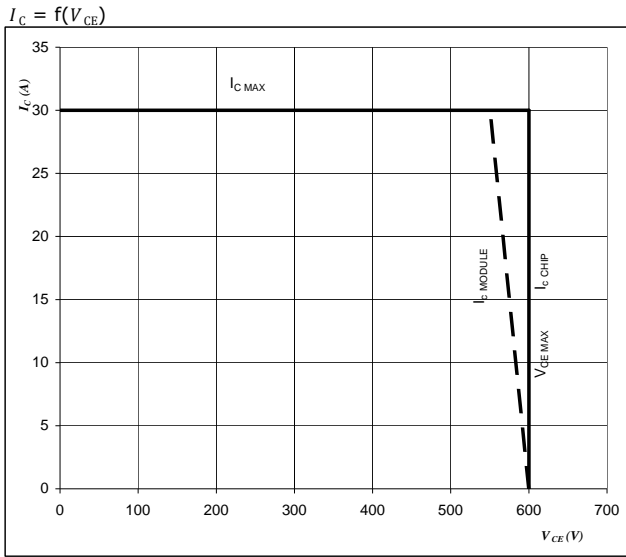

At
 $T_j = T_{j\text{ max}} - 25 \text{ } ^\circ\text{C}$



Brake Characteristics

Figure 1 IGBT

Typical output characteristics

$I_C = f(V_{CE})$

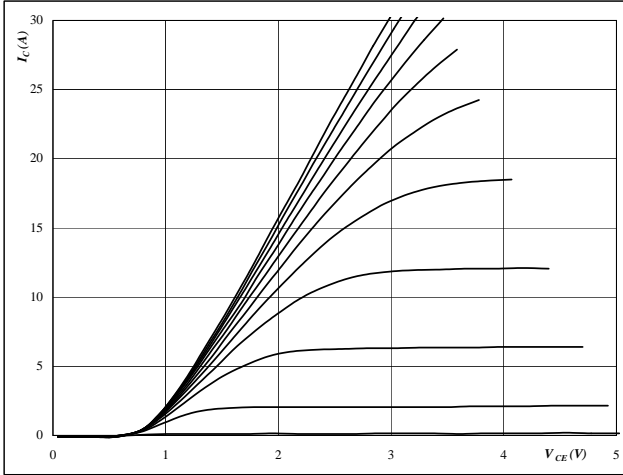

At
 $t_p = 250 \mu s$
 $T_j = 25 \text{ } ^\circ C$
 V_{GE} from 7 V to 17 V in steps of 1 V

Figure 2 IGBT

Typical output characteristics

$I_C = f(V_{CE})$

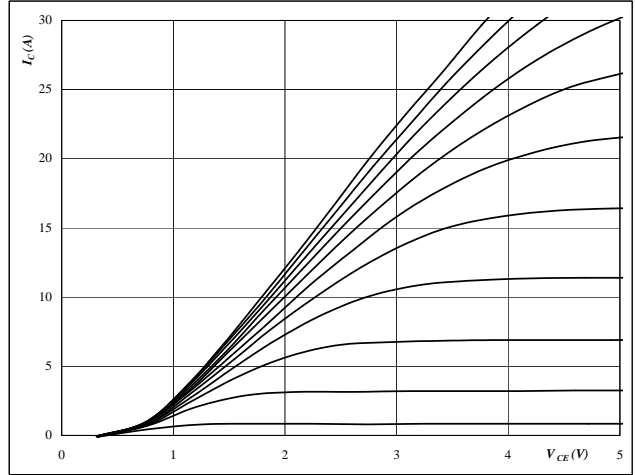

At
 $t_p = 250 \mu s$
 $T_j = 125 \text{ } ^\circ C$
 V_{GE} from 7 V to 17 V in steps of 1 V

Figure 3 IGBT

Typical transfer characteristics

$I_C = f(V_{GE})$

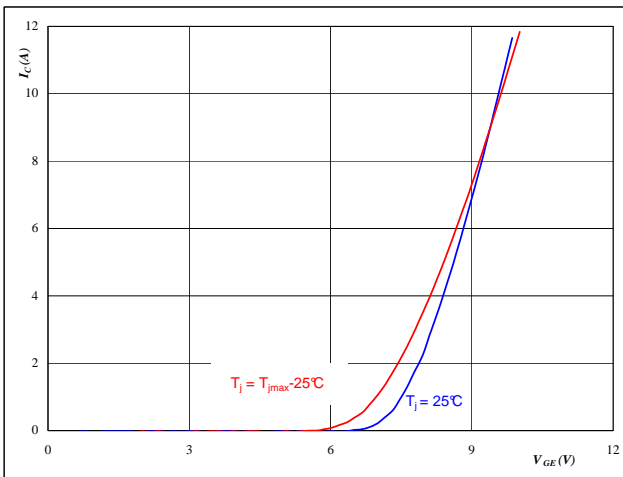

At
 $t_p = 250 \mu s$
 $V_{CE} = 10 V$

Figure 4 FWD

Typical diode forward current as a function of forward voltage

$I_F = f(V_F)$

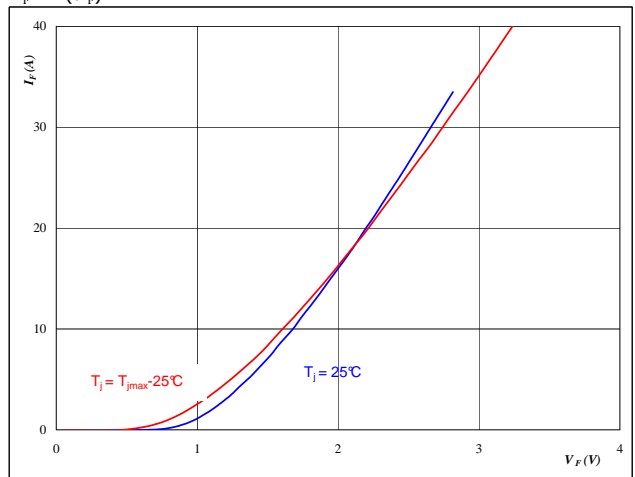

At
 $t_p = 250 \mu s$



Brake Characteristics

Figure 5 IGBT

Typical switching energy losses
as a function of collector current

$E = f(I_C)$

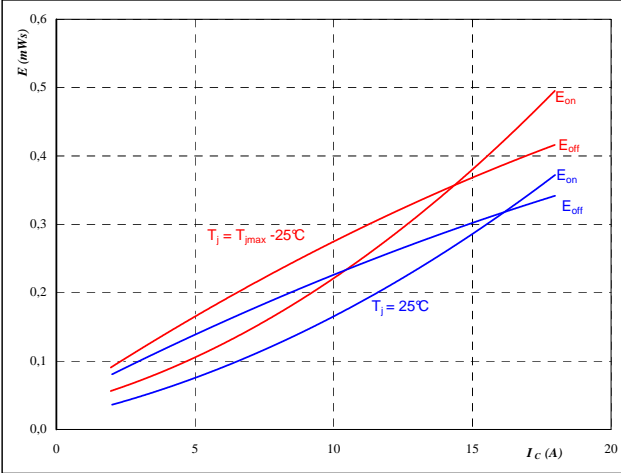

With an inductive load at
 $T_j = 25/125$ °C
 $V_{CE} = 300$ V
 $V_{GE} = 15$ V
 $R_{gon} = 32$ Ω
 $R_{goff} = 16$ Ω

Figure 6 IGBT

Typical switching energy losses
as a function of gate resistor

$E = f(R_G)$

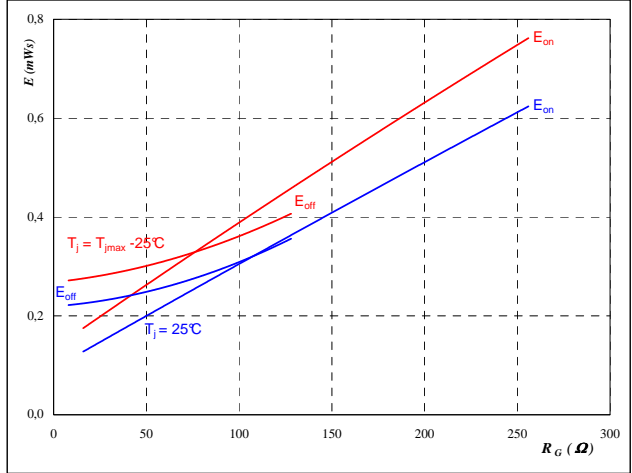

With an inductive load at
 $T_j = 25/125$ °C
 $V_{CE} = 300$ V
 $V_{GE} = 15$ V
 $I_C = 10$ A

Figure 7 FWD

Typical reverse recovery energy loss
as a function of collector current

$E_{rec} = f(I_C)$

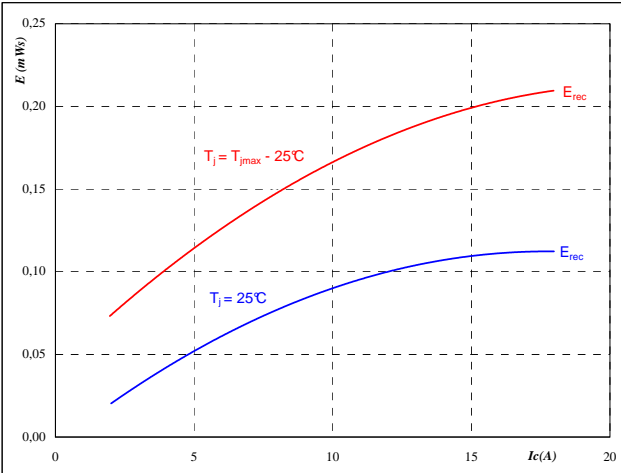

With an inductive load at
 $T_j = 25/125$ °C
 $V_{CE} = 300$ V
 $V_{GE} = 15$ V
 $R_{gon} = 32$ Ω

Figure 8 FWD

Typical reverse recovery energy loss
as a function of gate resistor

$E_{rec} = f(R_G)$

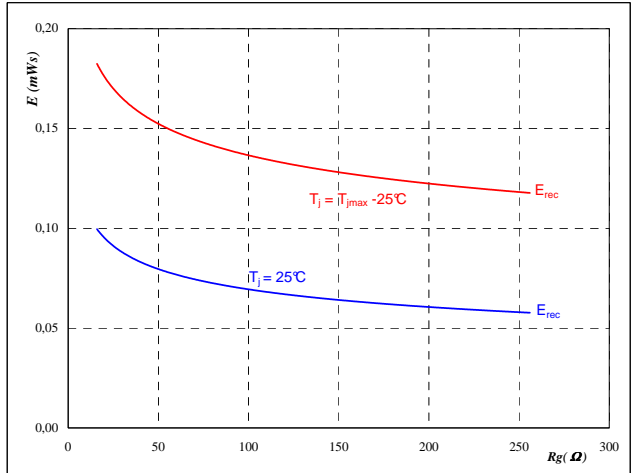

With an inductive load at
 $T_j = 25/125$ °C
 $V_{CE} = 300$ V
 $V_{GE} = 15$ V
 $I_C = 10$ A



Brake Characteristics

Figure 9 IGBT

Typical switching times as a function of collector current

$$t = f(I_C)$$

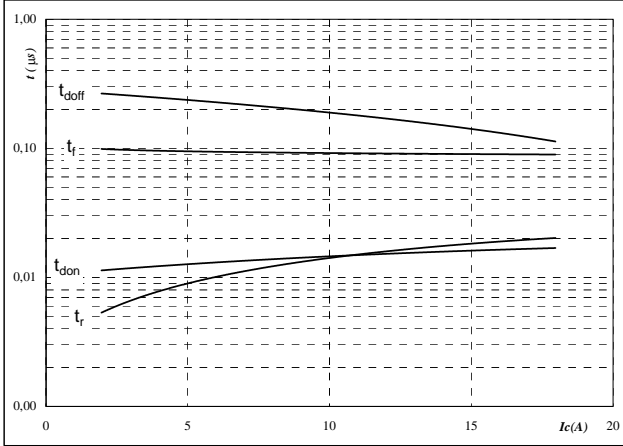

With an inductive load at
 $T_j = 25/125 \text{ } ^\circ\text{C}$
 $V_{CE} = 300 \text{ V}$
 $V_{GE} = 15 \text{ V}$
 $R_{gon} = 32 \text{ } \Omega$
 $R_{goff} = 16 \text{ } \Omega$

Figure 10 IGBT

Typical switching times as a function of gate resistor

$$t = f(R_G)$$

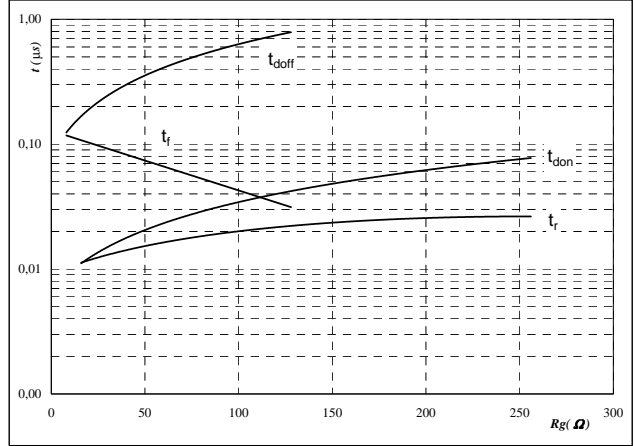

With an inductive load at
 $T_j = 25/125 \text{ } ^\circ\text{C}$
 $V_{CE} = 300 \text{ V}$
 $V_{GE} = 15 \text{ V}$
 $I_C = 10 \text{ A}$

Figure 11 IGBT

IGBT transient thermal impedance as a function of pulse width

$$Z_{th(j-s)} = f(t_p)$$

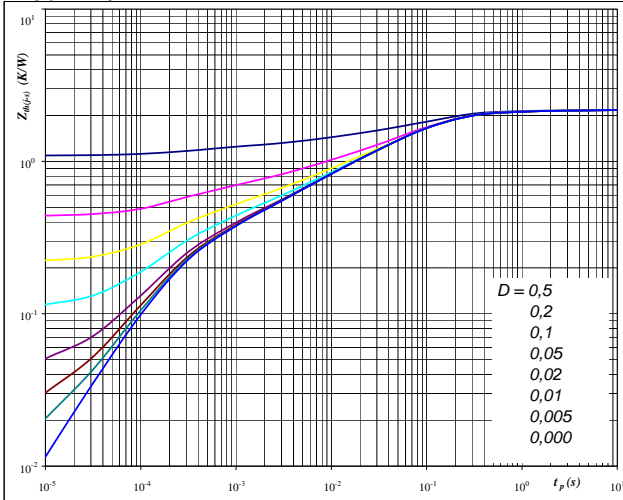

At $D = t_p / T$

$R_{th(j-s)} = 2,18 \text{ K/W}$

IGBT thermal model values

R (K/W)	Tau (s)
6,23E-02	3,85E+00
2,40E-01	3,55E-01
1,02E+00	7,88E-02
3,88E-01	1,12E-02
2,21E-01	2,12E-03
2,50E-01	2,46E-04

Figure 12 FWD

FWD transient thermal impedance as a function of pulse width

$$Z_{th(j-s)} = f(t_p)$$

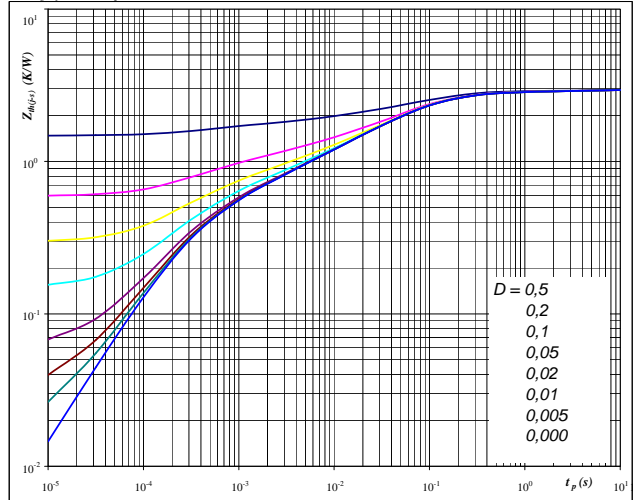

At $D = t_p / T$

$R_{th(j-s)} = 2,94 \text{ K/W}$

FWD thermal model values

R (K/W)	Tau (s)
1,11E-01	4,12E+00
3,47E-01	2,83E-01
1,28E+00	6,32E-02
4,92E-01	1,17E-02
3,46E-01	1,99E-03
3,70E-01	2,99E-04



Brake Characteristics

Figure 13 IGBT

Power dissipation as a function of heatsink temperature

$$P_{tot} = f(T_s)$$

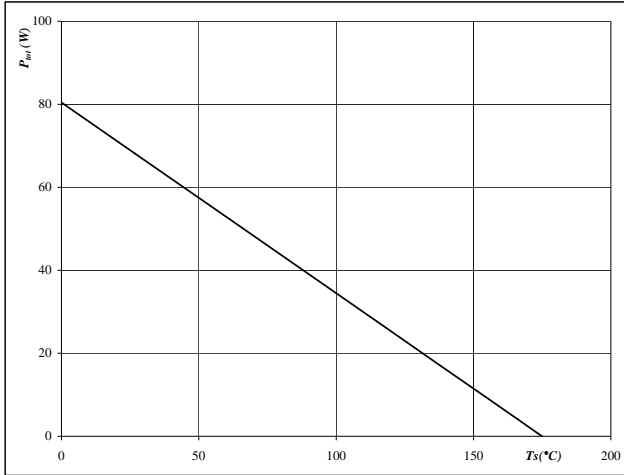

At
T_j = 175 °C

Figure 14 IGBT

Collector current as a function of heatsink temperature

$$I_C = f(T_s)$$

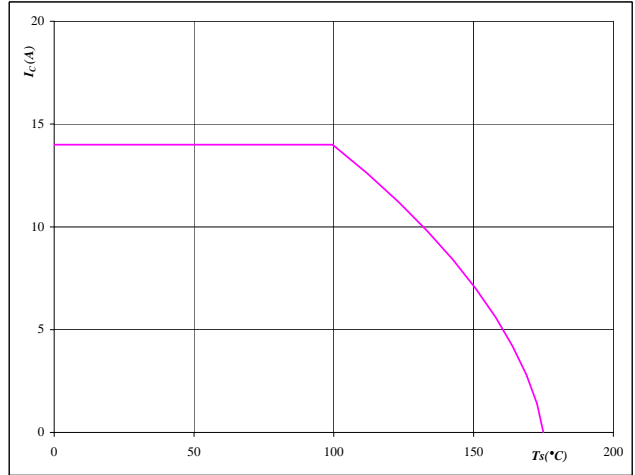

At
T_j = 175 °C
V_{GE} = 15 V

Figure 15 FWD

Power dissipation as a function of heatsink temperature

$$P_{tot} = f(T_s)$$

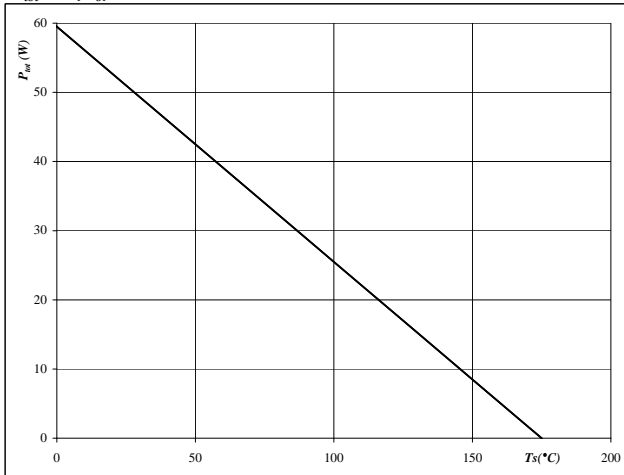

At
T_j = 175 °C

Figure 16 FWD

Forward current as a function of heatsink temperature

$$I_F = f(T_s)$$

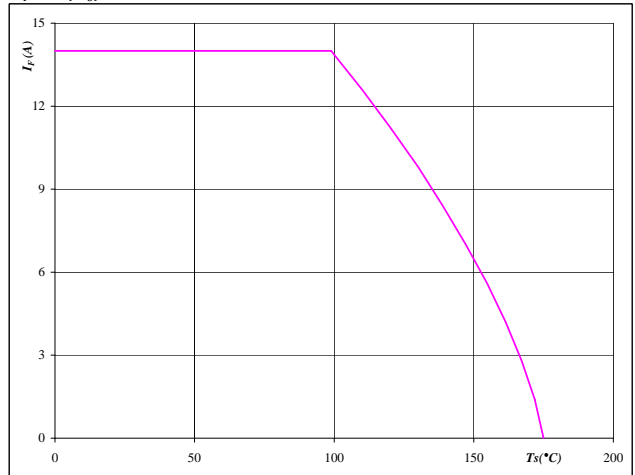

At
T_j = 175 °C



Rectifier Characteristics

Figure 1 Diode

Typical diode forward current as a function of forward voltage

$$I_F = f(V_F)$$

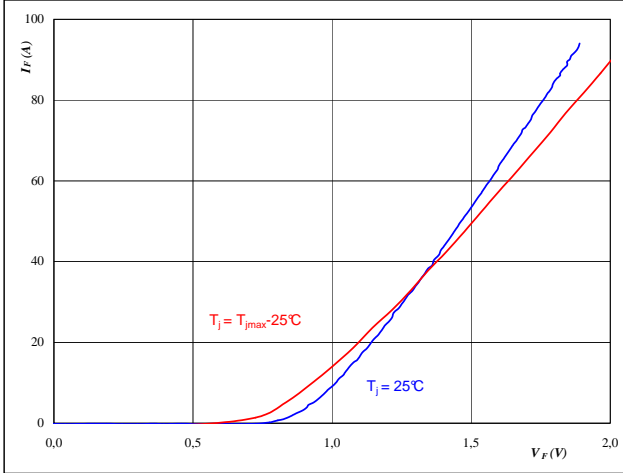

At $t_p = 250 \mu\text{s}$

Figure 2 Diode

Diode transient thermal impedance as a function of pulse width

$$Z_{th(j-s)} = f(t_p)$$

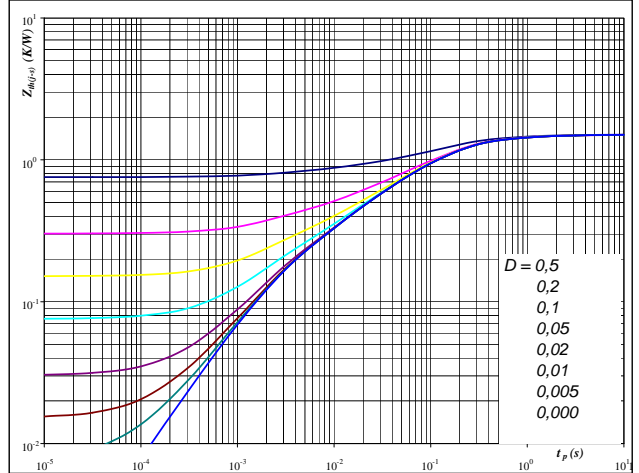

At $D = t_p / T$
 $R_{th(j-s)} = 1,51 \text{ K/W}$

Diode thermal model values

R (K/W)	Tau (s)
3,85E-02	6,40E+00
2,39E-01	5,50E-01
7,82E-01	1,14E-01
3,05E-01	2,08E-02
1,45E-01	2,53E-03

Figure 3 Diode

Power dissipation as a function of heatsink temperature

$$P_{tot} = f(T_s)$$

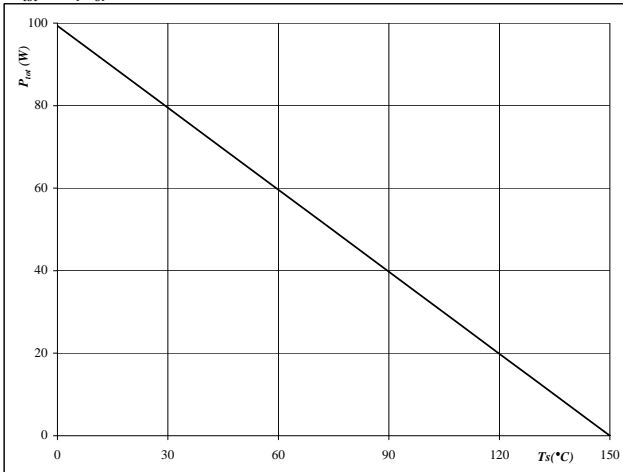

At $T_j = 150 \text{ }^\circ\text{C}$

Figure 4 Diode

Forward current as a function of heatsink temperature

$$I_F = f(T_s)$$

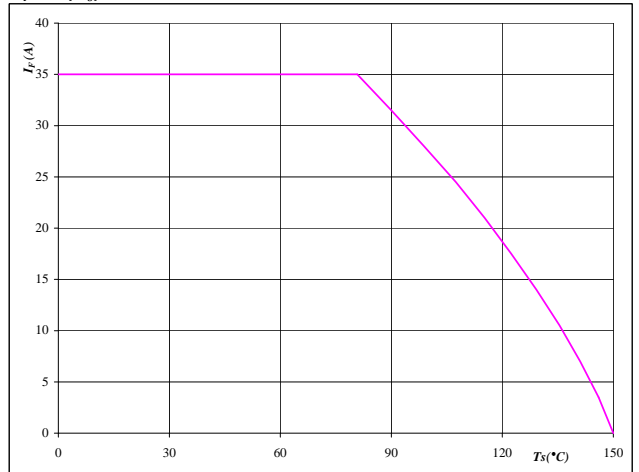

At $T_j = 150 \text{ }^\circ\text{C}$



Thermistor

Figure 1 Thermistor

Typical NTC characteristic
as a function of temperature

$$R_T = f(T)$$

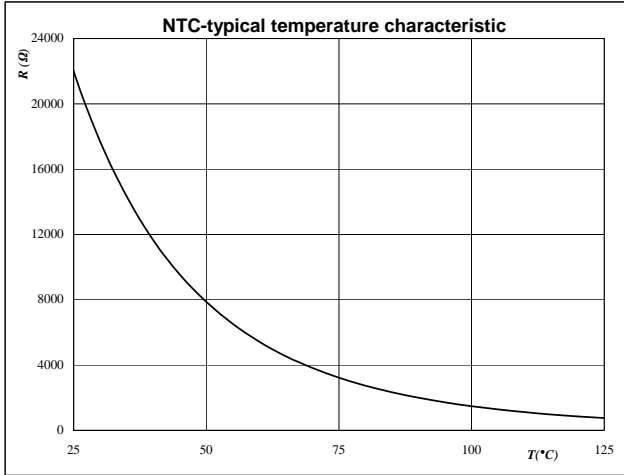



Switching Definitions Inverter

General conditions

T_j	=	125 °C
R_{gon}	=	32 Ω
R_{goff}	=	16 Ω

Figure 1 IGBT

Turn-off Switching Waveforms & definition of t_{doff} t_{Eoff}
(t_{Eoff} = integrating time for E_{off})

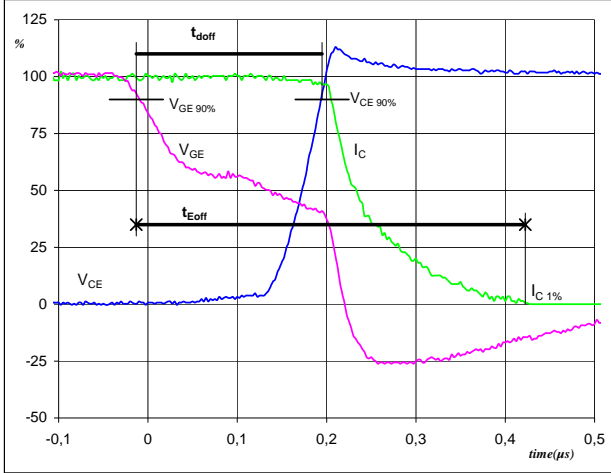

V_{GE} (0%) =	0	V
V_{GE} (100%) =	15	V
V_C (100%) =	300	V
I_C (100%) =	15	A
t_{doff} =	0,21	μs
t_{Eoff} =	0,44	μs

Figure 2 IGBT

Turn-on Switching Waveforms & definition of t_{don} t_{Eon}
(t_{Eon} = integrating time for E_{on})

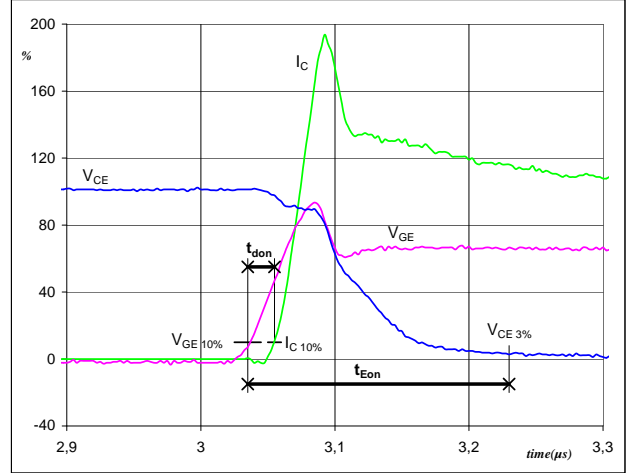

V_{GE} (0%) =	0	V
V_{GE} (100%) =	15	V
V_C (100%) =	300	V
I_C (100%) =	15	A
t_{don} =	0,02	μs
t_{Eon} =	0,20	μs

Figure 3 IGBT

Turn-off Switching Waveforms & definition of t_f

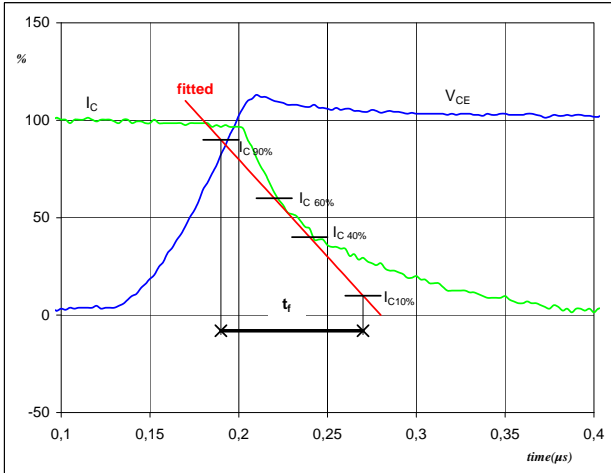

V_C (100%) =	300	V
I_C (100%) =	15	A
t_f =	0,09	μs

Figure 4 IGBT

Turn-on Switching Waveforms & definition of t_r

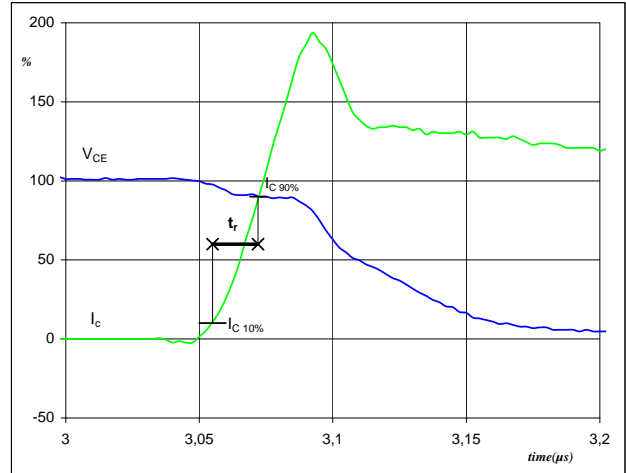

V_C (100%) =	300	V
I_C (100%) =	15	A
t_r =	0,02	μs



Switching Definitions Inverter

Figure 5 IGBT
Turn-off Switching Waveforms & definition of t_{Eoff}

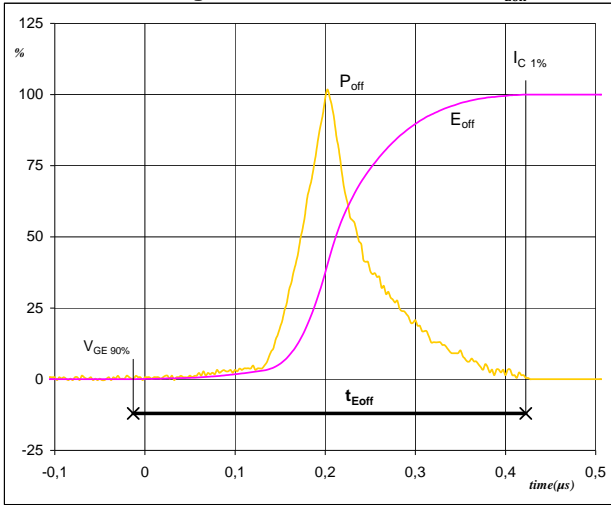

$P_{off} (100\%) = 4,47 \text{ kW}$
 $E_{off} (100\%) = 0,40 \text{ mJ}$
 $t_{Eoff} = 0,44 \text{ μs}$

Figure 6 IGBT
Turn-on Switching Waveforms & definition of t_{Eon}

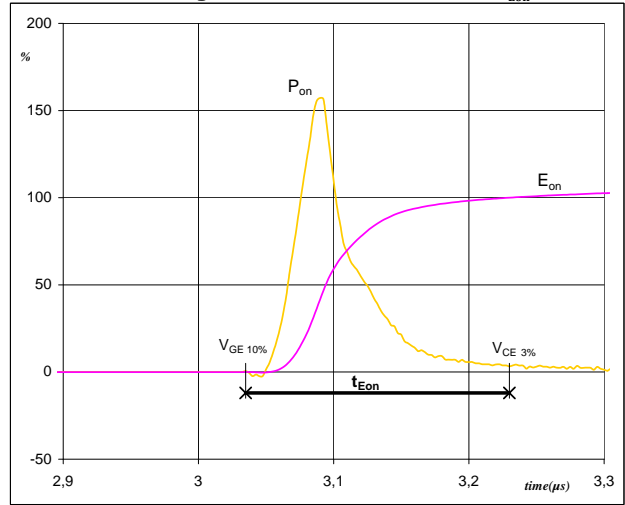

$P_{on} (100\%) = 4,47 \text{ kW}$
 $E_{on} (100\%) = 0,34 \text{ mJ}$
 $t_{Eon} = 0,20 \text{ μs}$

Figure 7 FWD
Turn-off Switching Waveforms & definition of t_{rr}

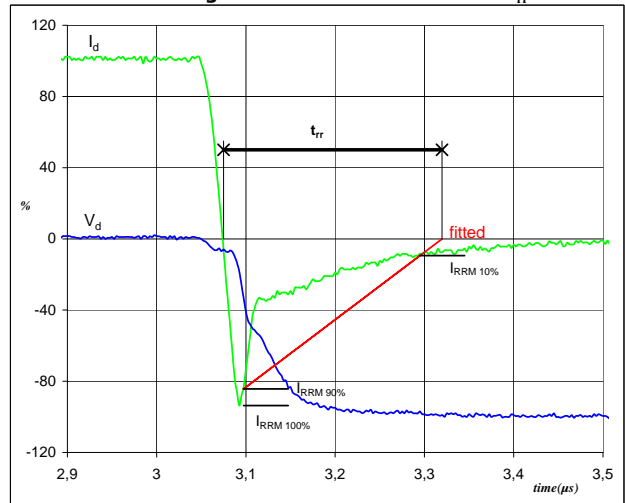

$V_d (100\%) = 300 \text{ V}$
 $I_d (100\%) = 15 \text{ A}$
 $I_{RRM} (100\%) = 14 \text{ A}$
 $t_{rr} = 0,21 \text{ μs}$



Switching Definitions Inverter

Figure 8 FWD
Turn-on Switching Waveforms & definition of $t_{Q_{rr}}$
($t_{Q_{rr}}$ = integrating time for Q_{rr})

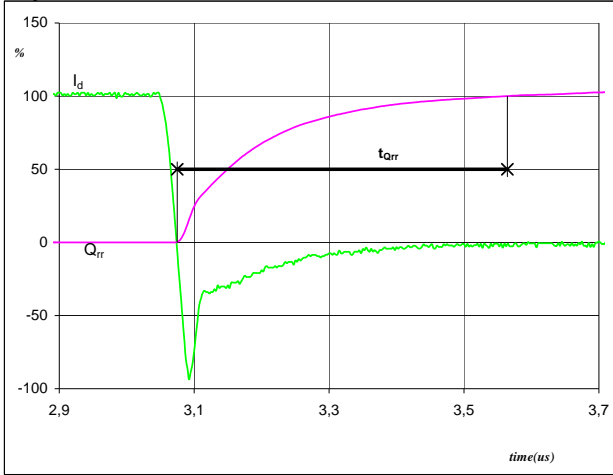

I_d (100%) =	15	A
Q_{rr} (100%) =	1,01	μC
$t_{Q_{rr}}$ =	0,49	μs

Figure 9 FWD
Turn-on Switching Waveforms & definition of $t_{E_{rec}}$
($t_{E_{rec}}$ = integrating time for E_{rec})

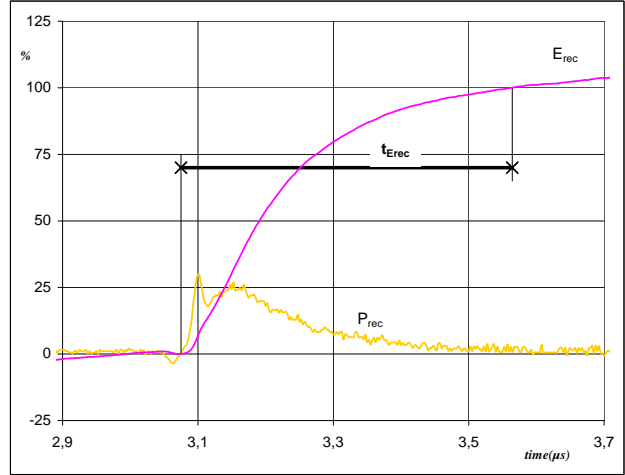

P_{rec} (100%) =	4,47	kW
E_{rec} (100%) =	0,20	mJ
$t_{E_{rec}}$ =	0,49	μs



Ordering Code and Marking - Outline - Pinout

Ordering Code & Marking						
Version	Ordering Code					
without thermal paste 12mm housing	V23990-P544-A28-PM					
with thermal paste 12mm housing	V23990-P544-A28-/3/-PM					
without thermal paste 17mm housing	V23990-P544-A29-PM					
without thermal paste 12mm housing 1 phase rectifier	V23990-P544-B28-PM					
with thermal paste 12mm housing 1 phase rectifier	V23990-P544-B28-/3/-PM					
with thermal paste 12mm housing 1 phase rectifier	V23990-P544-B128-/3/-PM					
without thermal paste 17mm housing 1phase rectifier	V23990-P544-B129-PM					
without thermal paste 17mm housing without brake	V23990-P544-C29-PM					
without thermal paste 12mm housing	V23990-P544-C28-PM					
with thermal paste 12mm housing	V23990-P544-C28-/3/-PM					

	Text	VIN	Date code	Name&Ver	UL	Lot	Serial
		VIN	WWYY	NNNNNVV	UL	LLLLL	SSSS
Datamatrix	Name&Ver	Lot number	Serial	Date code			
	NNNNNVV	LLLLL	SSSS	WWYY			

Pin table				Outline																				
Pin	X	Y	Function	<p>17mm housing</p>																				
1	25,5	2,7	NTC1																					
2	25,5	0	NTC2																					
3	22,8	0	DC-																					
4	20,1	0	BRCG																					
5	16,2	0	BRCE																					
6	13,5	0	G6																					
7	10,8	0	E6																					
8	8,1	0	G5																					
9	5,4	0	E5																					
10	2,7	0	G4																					
11	0	0	E4																					
12	0	19,8	G1		<p>12mm housing</p>																			
13	0	22,5	U																					
14	7,5	19,8	G2																					
15	7,5	22,5	V																					
16	15	19,8	G3																					
17	15	22,5	W																					
18	22,8	22,5	INV+																					
19	25,5	22,5	DC+																					
20	33,5	22,5	BRC+																					
21	33,5	15	L1																					
22	33,5	7,5	L2																					
23	33,5	0	L3																					
					<table border="1"> <thead> <tr> <th colspan="2">Pinout variation</th> </tr> <tr> <th>Module subtype</th> <th>Not assebled pins</th> </tr> </thead> <tbody> <tr> <td>V23990-P544-A28-PM</td> <td>-</td> </tr> <tr> <td>V23990-P544-A29-PM</td> <td>-</td> </tr> <tr> <td>V23990-P544-B28-PM</td> <td>21</td> </tr> <tr> <td>V23990-P544-B128-PM</td> <td>23</td> </tr> <tr> <td>V23990-P544-B129-PM</td> <td>23</td> </tr> <tr> <td>V23990-P544-C28-PM</td> <td>4, 5, 20</td> </tr> <tr> <td>V23990-P544-C29-PM</td> <td>4, 5, 20</td> </tr> </tbody> </table>		Pinout variation		Module subtype	Not assebled pins	V23990-P544-A28-PM	-	V23990-P544-A29-PM	-	V23990-P544-B28-PM	21	V23990-P544-B128-PM	23	V23990-P544-B129-PM	23	V23990-P544-C28-PM	4, 5, 20	V23990-P544-C29-PM	4, 5, 20
Pinout variation																								
Module subtype	Not assebled pins																							
V23990-P544-A28-PM	-																							
V23990-P544-A29-PM	-																							
V23990-P544-B28-PM	21																							
V23990-P544-B128-PM	23																							
V23990-P544-B129-PM	23																							
V23990-P544-C28-PM	4, 5, 20																							
V23990-P544-C29-PM	4, 5, 20																							



Ordering Code and Marking - Outline - Pinout

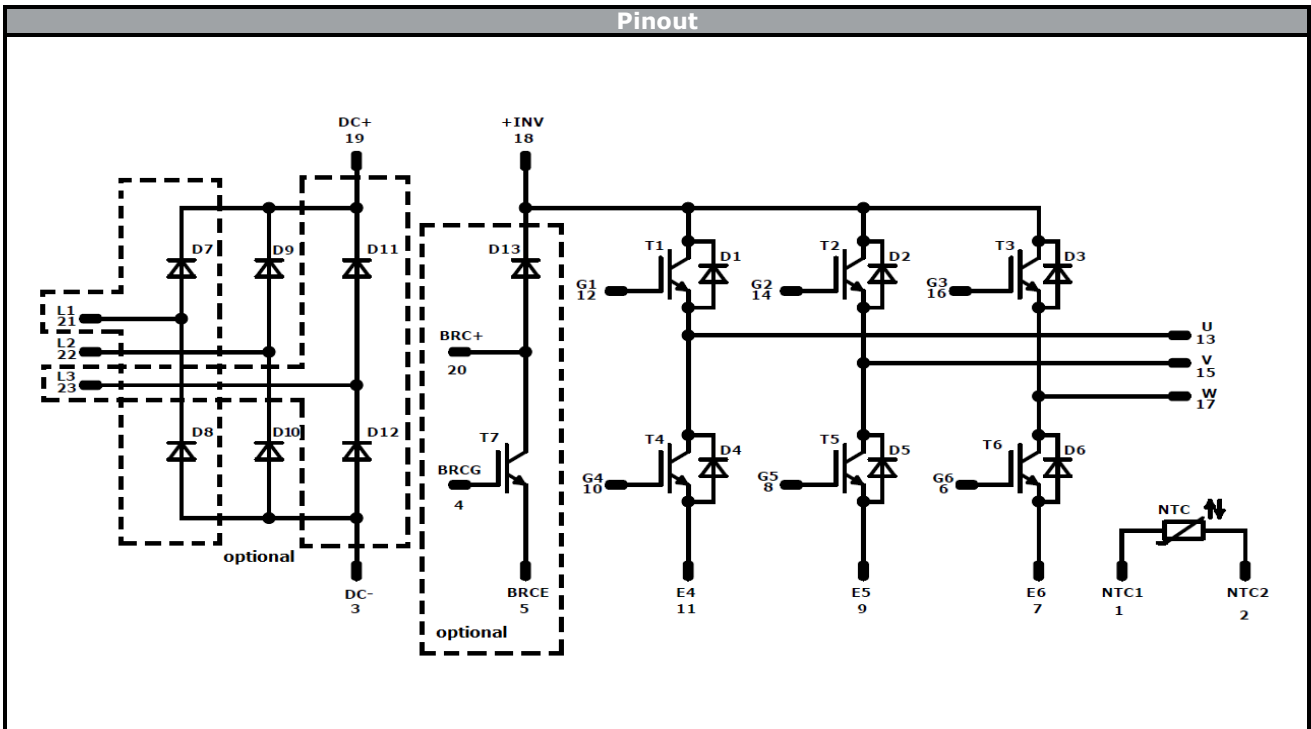

Identification

ID	Component	Voltage	Current	Function	Comment
D7,D8,D9,D10,D11,D12	Diode	1600 V	25 A	Rectifier Diode	
T1,T2,T3,T4,T5,T6	IGBT	600 V	15 A	Inverter Switch	
D1,D2,D3,D4,D5,D6	FWD	600 V	15 A	Inverter Diode	
T7	IGBT	600 V	10 A	Brake Switch	
D13	FWD	600 V	10 A	Brake Diode	
NTC	NTC			Thermistor	

**Packaging instruction**

Standard packaging quantity (SPQ)	135	>SPQ	Standard	<SPQ	Sample
-----------------------------------	------------	------	----------	------	--------

Handling instruction

Handling instructions for *flow* 0 packages see vincotech.com website.

Package data

Package data for *flow* 0 packages see vincotech.com website.

UL recognition and file number

This device is certified according to UL 1557 standard, UL file number E192116. For more information see vincotech.com website.



Document No.:	Date:	Modification:	Pages
V23990-P544-x2x-D8-14	27 Aug. 2019	P544-C28 added	1,22

DISCLAIMER

The information, specifications, procedures, methods and recommendations herein (together "information") are presented by Vincotech to reader in good faith, are believed to be accurate and reliable, but may well be incomplete and/or not applicable to all conditions or situations that may exist or occur. Vincotech reserves the right to make any changes without further notice to any products to improve reliability, function or design. No representation, guarantee or warranty is made to reader as to the accuracy, reliability or completeness of said information or that the application or use of any of the same will avoid hazards, accidents, losses, damages or injury of any kind to persons or property or that the same will not infringe third parties rights or give desired results. It is reader's sole responsibility to test and determine the suitability of the information and the product for reader's intended use.

LIFE SUPPORT POLICY

Vincotech products are not authorised for use as critical components in life support devices or systems without the express written approval of Vincotech.

As used herein:

1. Life support devices or systems are devices or systems which, (a) are intended for surgical implant into the body, or (b) support or sustain life, or (c) whose failure to perform when properly used in accordance with instructions for use provided in labelling can be reasonably expected to result in significant injury to the user.
2. A critical component is any component of a life support device or system whose failure to perform can be reasonably expected to cause the failure of the life support device or system, or to affect its safety or effectiveness.

单击下面可查看定价，库存，交付和生命周期等信息

[>>Vincotech\(威科\)](#)