

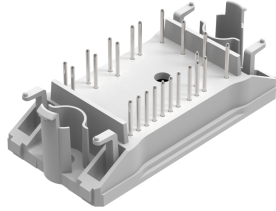

<b>flowPIM 0</b>		<b>1200 V / 10 A</b>	
<b>Features</b>		<b>flow 0 17 mm housing</b>	
<ul style="list-style-type: none"><li>• IGBT M7 with low VCEsat and improved EMC behavior</li><li>• Open emitter configuration</li><li>• Compact and low inductive design</li><li>• Built-in NTC</li></ul>			
<b>Target applications</b>		<b>Schematic</b>	
<ul style="list-style-type: none"><li>• Industrial Drives</li></ul>			
<b>Types</b>			
<ul style="list-style-type: none"><li>• 10-F012PMA010M7-P849A29</li></ul>			

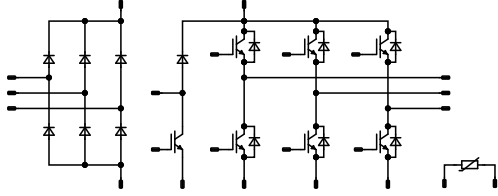

Vincotech

## Maximum Ratings

$T_j = 25\text{ °C}$ , unless otherwise specified

Parameter	Symbol	Conditions	Value	Unit
<b>Inverter Switch</b>				
Collector-emitter voltage	$V_{CES}$		1200	V
Collector current (DC current)	$I_C$	$T_j = T_{jmax}$ $T_s = 80\text{ °C}$	18	A
Repetitive peak collector current	$I_{CRM}$	$t_p$ limited by $T_{jmax}$	20	A
Total power dissipation	$P_{tot}$	$T_j = T_{jmax}$ $T_s = 80\text{ °C}$	55	W
Gate-emitter voltage	$V_{GES}$		$\pm 20$	V
Short circuit ratings	$t_{SC}$	$V_{GE} = 0\text{ V}$ , $V_{CC} = 800\text{ V}$ $T_j = 150\text{ °C}$	9,5	$\mu\text{s}$
Maximum junction temperature	$T_{jmax}$		175	$^{\circ}\text{C}$

<b>Inverter Diode</b>				
Peak repetitive reverse voltage	$V_{RRM}$		1200	V
Forward current (DC current)	$I_F$	$T_j = T_{jmax}$ $T_s = 80\text{ °C}$	19	A
Total power dissipation	$P_{tot}$	$T_j = T_{jmax}$ $T_s = 80\text{ °C}$	44	W
Maximum junction temperature	$T_{jmax}$		175	$^{\circ}\text{C}$

<b>Brake Switch</b>				
Collector-emitter voltage	$V_{CES}$		1200	V
Collector current (DC current)	$I_C$	$T_j = T_{jmax}$ $T_s = 80\text{ °C}$	11	A
Repetitive peak collector current	$I_{CRM}$	$t_p$ limited by $T_{jmax}$	10	A
Total power dissipation	$P_{tot}$	$T_j = T_{jmax}$ $T_s = 80\text{ °C}$	41	W
Gate-emitter voltage	$V_{GES}$		$\pm 20$	V
Short circuit ratings	$t_{SC}$	$V_{GE} = 15\text{ V}$ , $V_{CC} = 800\text{ V}$ $T_j = 150\text{ °C}$	9,5	$\mu\text{s}$
Maximum junction temperature	$T_{jmax}$		175	$^{\circ}\text{C}$



Vincotech

## Maximum Ratings

$T_j = 25\text{ °C}$ , unless otherwise specified

Parameter	Symbol	Conditions	Value	Unit
<b>Brake Diode</b>				
Peak repetitive reverse voltage	$V_{RRM}$		1200	V
Forward current (DC current)	$I_F$	$T_j = T_{jmax}$ $T_s = 80\text{ °C}$	11	A
Repetitive peak forward current	$I_{FRM}$	$t_p$ limited by $T_{jmax}$	10	A
Total power dissipation	$P_{tot}$	$T_j = T_{jmax}$ $T_s = 80\text{ °C}$	27	W
Maximum junction temperature	$T_{jmax}$		175	°C

## Rectifier Diode

Peak repetitive reverse voltage	$V_{RRM}$		1600	V
Forward current (DC current)	$I_F$	$T_j = T_{jmax}$ $T_s = 80\text{ °C}$	33	A
Surge (non-repetitive) forward current	$I_{FSM}$	Single Half Sine Wave, $t_p = 10\text{ ms}$ $T_j = 150\text{ °C}$	200	A
Surge current capability	$I^2t$		200	A <sup>2</sup> s
Total power dissipation	$P_{tot}$	$T_j = T_{jmax}$ $T_s = 80\text{ °C}$	44	W
Maximum junction temperature	$T_{jmax}$		150	°C

## Module Properties

### Thermal Properties

Storage temperature	$T_{stg}$		-40...+125	°C
Operation temperature under switching condition	$T_{jop}$		-40...+( $T_{jmax} - 25$ )	°C

### Isolation Properties

Isolation voltage	$V_{isol}$	DC Test Voltage* $t_p = 2\text{ s}$	6000	V
Isolation voltage	$V_{isol}$	AC Voltage $t_p = 1\text{ min}$	2500	V
Creepage distance			>12,7	mm
Clearance			>12,7	mm
Comparative Tracking Index	CTI		≥ 200	

\*100 % tested in production



Vincotech

### Characteristic Values

Parameter	Symbol	Conditions					Values			Unit
		$V_{GS}$ [V]	$V_{GE}$ [V]	$V_{DS}$ [V]	$V_F$ [V]	$I_C$ [A] $I_D$ [A] $I_F$ [A]	$T_j$ [°C]	Min	Typ	

#### Inverter Switch

##### Static

Gate-emitter threshold voltage	$V_{GE(th)}$			10	0,001	25	5,4	6	6,6	V
Collector-emitter saturation voltage	$V_{CE(sat)}$		15		10	25 125 150		1,66 1,9 1,96	2,15 <sup>(1)</sup>	V
Collector-emitter cut-off current	$I_{CES}$		0	1200		25			35	μA
Gate-emitter leakage current	$I_{GES}$		0	0		25			500	nA
Internal gate resistance	$r_g$							None		Ω
Input capacitance	$C_{ies}$							2000		pF
Output capacitance	$C_{oes}$		0	10		25		86		pF
Reverse transfer capacitance	$C_{res}$							23		pF
Gate charge	$Q_g$	$V_{CC} = 600$ V	15		10	25		80		nC

##### Thermal

Thermal resistance junction to sink <sup>(2)</sup>	$R_{th(j-s)}$	$\lambda_{paste} = 3,4$ W/mK (PSX)						1,72		K/W
--	---------------	---------------------------------------	--	--	--	--	--	------	--	-----

##### Dynamic

Turn-on delay time	$t_{d(on)}$					25 125 150		127,8 125,6 123,4		ns
Rise time	$t_r$					25 125 150		29 32,2 33,8		ns
Turn-off delay time	$t_{d(off)}$					25 125 150		145,2 179,2 182		ns
Fall time	$t_f$					25 125 150		98,1 107,57 116,71		ns
Turn-on energy (per pulse)	$E_{on}$	$Q_{tFWD} = 1,09$ μC $Q_{tFWD} = 1,66$ μC $Q_{tFWD} = 1,81$ μC				25 125 150		0,883 1,12 1,19		mWs
Turn-off energy (per pulse)	$E_{off}$					25 125 150		0,656 0,86 0,908		mWs



Vincotech

10-F012PMA010M7-P849A29  
datasheet

### Characteristic Values

Parameter	Symbol	Conditions					Values			Unit
		$V_{GE}$ [V] $V_{GS}$ [V]	$V_{CE}$ [V] $V_{DS}$ [V] $V_F$ [V]	$I_C$ [A] $I_D$ [A] $I_F$ [A]	$T_j$ [°C]	Min	Typ	Max		
<b>Inverter Diode</b>										
<b>Static</b>										
Forward voltage	$V_F$				10	25 125 150		1,61 1,69 1,7	2,1 <sup>(1)</sup>	V
Reverse leakage current	$I_R$	$V_r = 1200$ V				25			25	μA
<b>Thermal</b>										
Thermal resistance junction to sink <sup>(2)</sup>	$R_{th(j-s)}$	$\lambda_{paste} = 3,4$ W/mK (PSX)						2,16		K/W
<b>Dynamic</b>										
Peak recovery current	$I_{RRM}$					25 125 150		8,67 9,25 9,34		A
Reverse recovery time	$t_{rr}$					25 125 150		254,4 372,9 409		ns
Recovered charge	$Q_r$	$di/dt=278$ A/μs $di/dt=270$ A/μs $di/dt=272$ A/μs	±15	600	10	25 125 150		1,09 1,66 1,81		μC
Reverse recovered energy	$E_{rec}$					25 125 150		0,374 0,62 0,68		mWs
Peak rate of fall of recovery current	$(di_r/dt)_{max}$					25 125 150		84,75 53,58 49,28		A/μs



Vincotech

### Characteristic Values

Parameter	Symbol	Conditions					Values			Unit
		$V_{GS}$ [V]	$V_{GE}$ [V]	$V_{DS}$ [V]	$V_F$ [V]	$I_C$ [A] $I_D$ [A] $I_F$ [A]	$T_j$ [°C]	Min	Typ	

#### Brake Switch

##### Static

Gate-emitter threshold voltage	$V_{GE(th)}$			10	0,0005	25	5,4	6	6,6	V
Collector-emitter saturation voltage	$V_{CE(sat)}$		15		5	25 125 150		1,63 1,83 1,9	1,95 <sup>(1)</sup>	V
Collector-emitter cut-off current	$I_{CES}$		0	1200		25			20	μA
Gate-emitter leakage current	$I_{GES}$		20	0		25			500	nA
Internal gate resistance	$r_g$							None		Ω
Input capacitance	$C_{ies}$							1100		pF
Output capacitance	$C_{oes}$		0	10		25		57		pF
Reverse transfer capacitance	$C_{res}$							11		pF
Gate charge	$Q_g$	$V_{CC} = 600$ V	15		5	25		40		nC

##### Thermal

Thermal resistance junction to sink <sup>(2)</sup>	$R_{th(j-s)}$	$\lambda_{paste} = 3,4$ W/mK (PSX)						2,3		K/W
--	---------------	---------------------------------------	--	--	--	--	--	-----	--	-----

##### Dynamic

Turn-on delay time	$t_{d(on)}$					25 125 150		78,6 73 72,2		ns
Rise time	$t_r$					25 125 150		44,6 48,4 49		ns
Turn-off delay time	$t_{d(off)}$					25 125 150		234,4 261,6 269,8		ns
Fall time	$t_f$					25 125 150		101,2 114,14 117,21		ns
Turn-on energy (per pulse)	$E_{on}$	$Q_{tFWD} = 0,558$ μC $Q_{tFWD} = 0,833$ μC $Q_{tFWD} = 0,935$ μC				25 125 150		0,48 0,609 0,634		mWs
Turn-off energy (per pulse)	$E_{off}$					25 125 150		0,345 0,454 0,474		mWs



Vincotech

### Characteristic Values

Parameter	Symbol	Conditions					Values			Unit
		$V_{GE}$ [V] $V_{GS}$ [V]	$V_{CE}$ [V] $V_{DS}$ [V] $V_F$ [V]	$I_C$ [A] $I_D$ [A] $I_F$ [A]	$T_j$ [°C]	Min	Typ	Max		
<b>Brake Diode</b>										
<b>Static</b>										
Forward voltage	$V_F$			5	25 125 150		1,57 1,66 1,65	2,1 <sup>(1)</sup>		V
Reverse leakage current	$I_R$	$V_T = 1200$ V			25			20		μA
<b>Thermal</b>										
Thermal resistance junction to sink <sup>(2)</sup>	$R_{th(j-s)}$	$\lambda_{paste} = 3,4$ W/mK (PSX)						3,5		K/W
<b>Dynamic</b>										
Peak recovery current	$I_{RRM}$				25 125 150		3,83 4,17 4,24			A
Reverse recovery time	$t_{rr}$				25 125 150		258,78 386,26 431,26			ns
Recovered charge	$Q_r$	$di/dt=85$ A/μs $di/dt=102$ A/μs $di/dt=87$ A/μs	0/15	600	5	25 125 150	0,558 0,833 0,935			μC
Reverse recovered energy	$E_{rec}$				25 125 150		0,2 0,314 0,362			mWs
Peak rate of fall of recovery current	$(di_r/dt)_{max}$				25 125 150		37,47 24,29 19,53			A/μs



### Characteristic Values

Parameter	Symbol	Conditions					Values			Unit
		$V_{GE}$ [V] $V_{GS}$ [V]	$V_{CE}$ [V] $V_{DS}$ [V] $V_F$ [V]	$I_C$ [A] $I_D$ [A] $I_F$ [A]	$T_j$ [°C]	Min	Typ	Max		

#### Rectifier Diode

##### Static

Forward voltage	$V_F$				8	25 125		0,996 0,907	1,21 <sup>(1)</sup> 1,1 <sup>(1)</sup>	V
Reverse leakage current	$I_R$	$V_i = 1600$ V				25			50	μA

##### Thermal

Thermal resistance junction to sink <sup>(2)</sup>	$R_{th(j-s)}$	$\lambda_{paste} = 3,4$ W/mK (PSX)						1,59		K/W
--	---------------	---------------------------------------	--	--	--	--	--	------	--	-----

#### Thermistor

##### Static

Rated resistance	$R$					25		22		kΩ
Deviation of $R_{100}$	$\Delta_{R/R}$	$R_{100} = 1484$ Ω				100	-5		5	%
Power dissipation	$P$							5		mW
Power dissipation constant	$d$					25		1,5		mW/K
B-value	$B_{(25/50)}$	Tol. ±1 %						3962		K
B-value	$B_{(25/100)}$	Tol. ±1 %						4000		K
Vincotech Thermistor Reference									I	

<sup>(1)</sup> Value at chip level

<sup>(2)</sup> Only valid with pre-applied Vincotech thermal interface material.





## Inverter Switch Characteristics

**figure 1.** IGBT

Typical output characteristics

$$I_C = f(V_{CE})$$

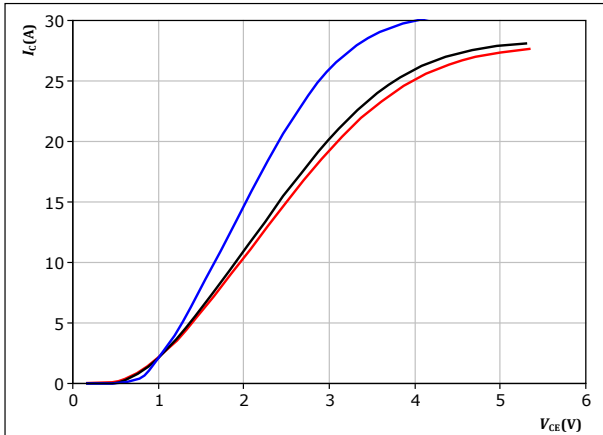

$t_p = 250 \mu s$   
 $V_{GE} = 15 V$   
 $T_j:$  — 25 °C  
 — 125 °C  
 — 150 °C

**figure 2.** IGBT

Typical output characteristics

$$I_C = f(V_{CE})$$

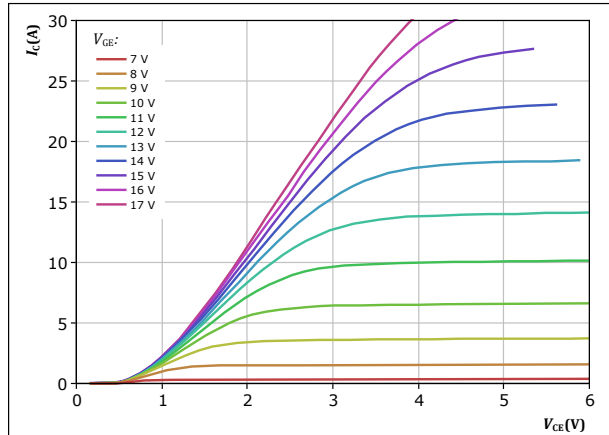

$t_p = 250 \mu s$   
 $T_j = 150 \text{ °C}$   
 $V_{GE}$  from 7 V to 17 V in steps of 1 V

**figure 3.** IGBT

Typical transfer characteristics

$$I_C = f(V_{GE})$$

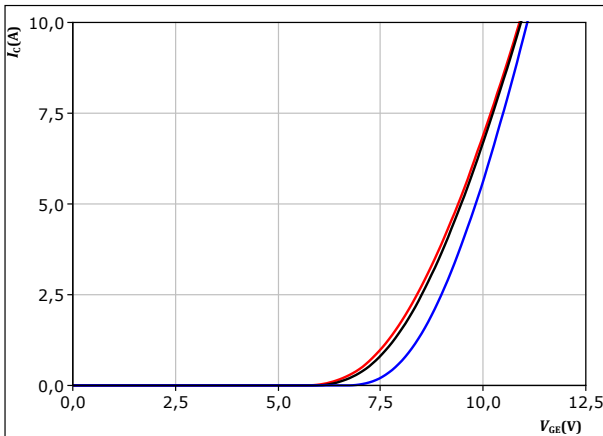

$t_p = 250 \mu s$   
 $V_{CE} = 10 V$   
 $T_j:$  — 25 °C  
 — 125 °C  
 — 150 °C

**figure 4.** IGBT

Transient thermal impedance as a function of pulse width

$$Z_{th(j-s)} = f(t_p)$$

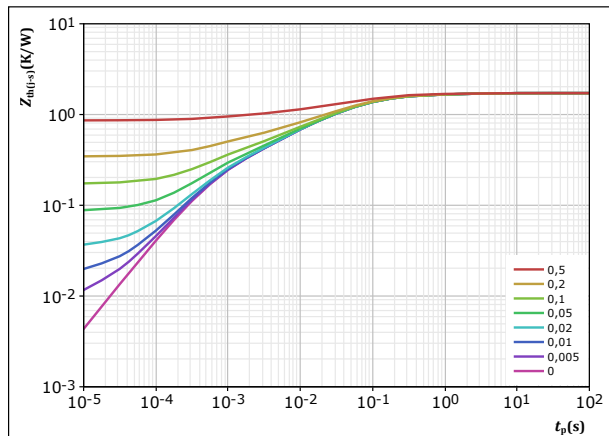

$D = t_p / T$   
 $R_{th(j-s)} = 1,722 \text{ K/W}$   
 IGBT thermal model values  

R (K/W)	$\tau$ (s)
8,08E-02	2,32E+00
2,21E-01	2,45E-01
6,51E-01	6,03E-02
3,93E-01	1,33E-02
1,95E-01	3,15E-03
1,82E-01	5,45E-04



### Inverter Switch Characteristics

figure 5. IGBT

Safe operating area

$$I_C = f(V_{CE})$$

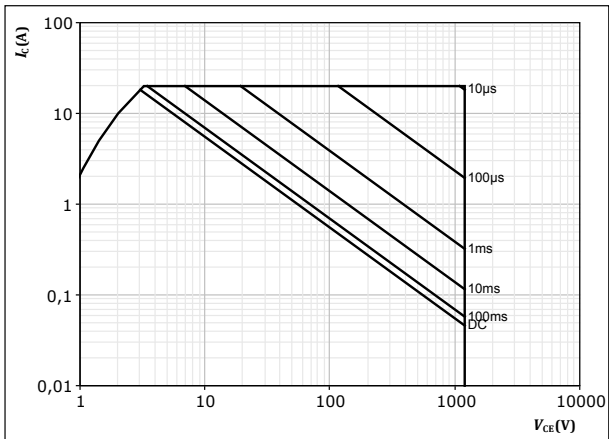

$D =$  single pulse  
 $T_s = 80 \text{ } ^\circ\text{C}$   
 $V_{GE} = 15 \text{ V}$   
 $T_j = T_{jmax}$



### Inverter Diode Characteristics

figure 6. FWD

Typical forward characteristics

$$I_F = f(V_F)$$

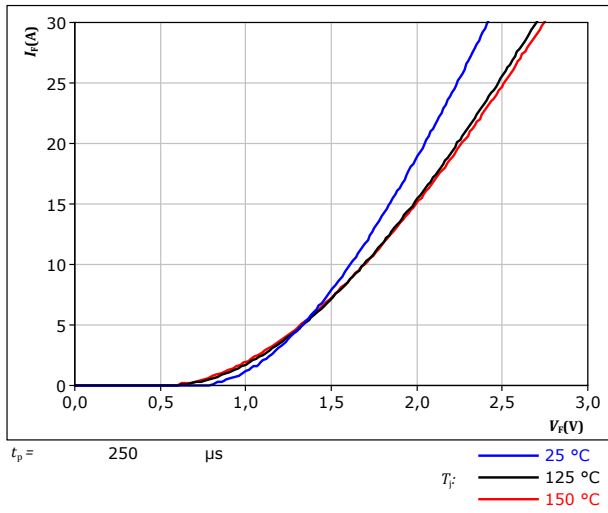
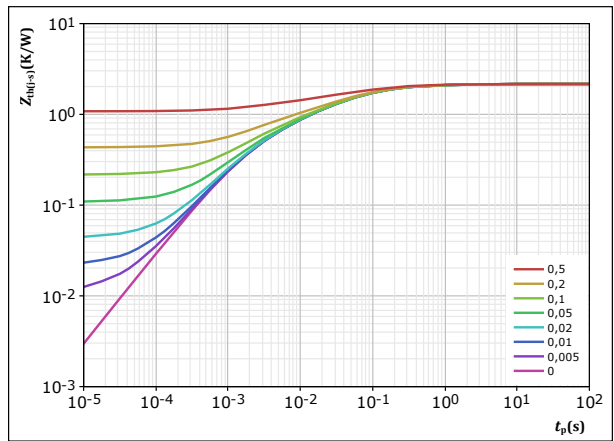

figure 7. FWD

Transient thermal impedance as a function of pulse width

$$Z_{th(j-s)} = f(t_p)$$



$D = t_p / T$   
 $R_{th(j-s)} = 2,162 \text{ K/W}$   
 FWD thermal model values

R (K/W)	$\tau$ (s)
9,29E-02	2,25E+00
3,88E-01	2,05E-01
7,75E-01	5,06E-02
5,89E-01	8,88E-03
3,17E-01	1,48E-03



### Brake Switch Characteristics

**figure 8.** IGBT

Typical output characteristics  
 $I_C = f(V_{CE})$

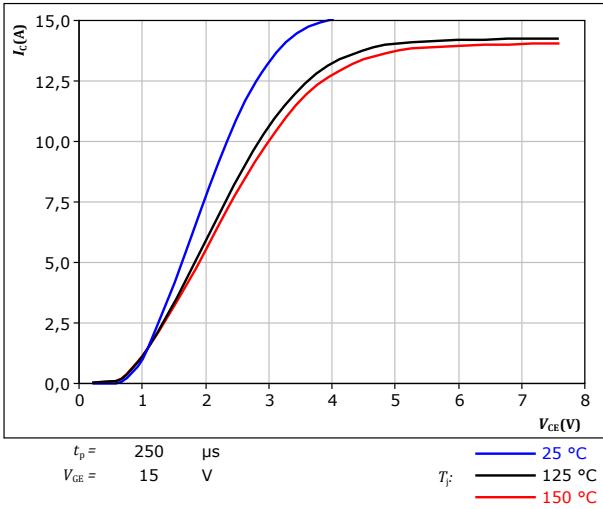

**figure 9.** IGBT

Typical output characteristics  
 $I_C = f(V_{CE})$

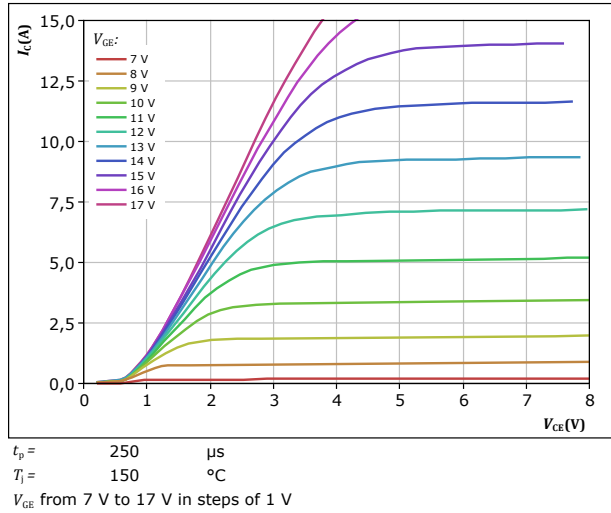

**figure 10.** IGBT

Typical transfer characteristics  
 $I_C = f(V_{GE})$

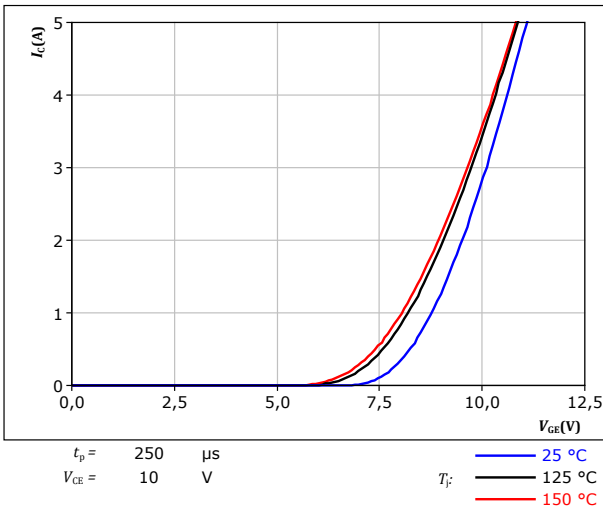

**figure 11.** IGBT

Transient thermal impedance as a function of pulse width  
 $Z_{th(j-s)} = f(t_p)$

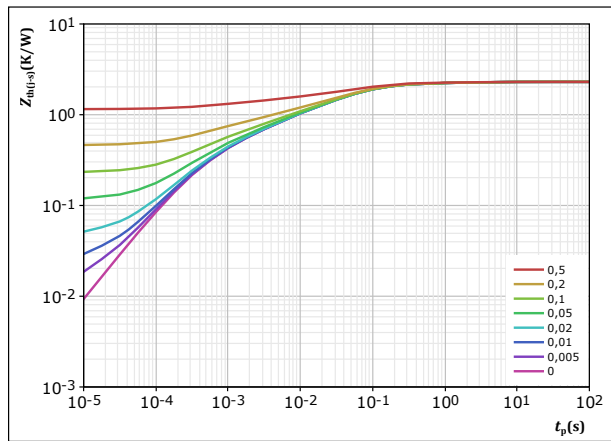

IGBT thermal model values

R (K/W)	$\tau$ (s)
6,25E-02	3,48E+00
1,37E-01	5,00E-01
7,38E-01	8,11E-02
5,28E-01	2,49E-02
3,84E-01	5,54E-03
2,39E-01	1,24E-03
2,13E-01	3,29E-04



### Brake Switch Characteristics

figure 12. IGBT

Safe operating area

$$I_C = f(V_{CE})$$

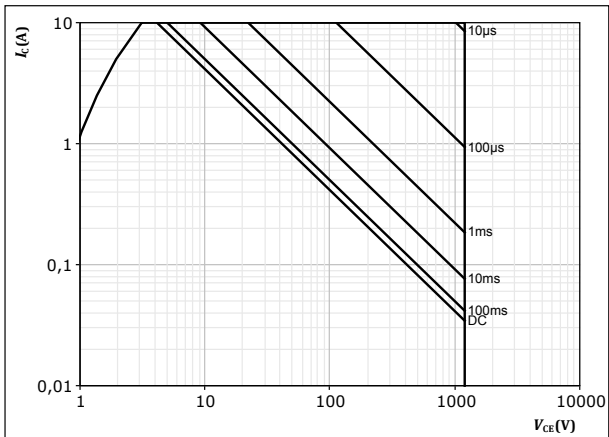

D = single pulse  
T<sub>s</sub> = 80 °C  
V<sub>GE</sub> = 15 V  
T<sub>j</sub> = T<sub>jmax</sub>



### Brake Diode Characteristics

figure 13. FWD

Typical forward characteristics

$$I_F = f(V_F)$$

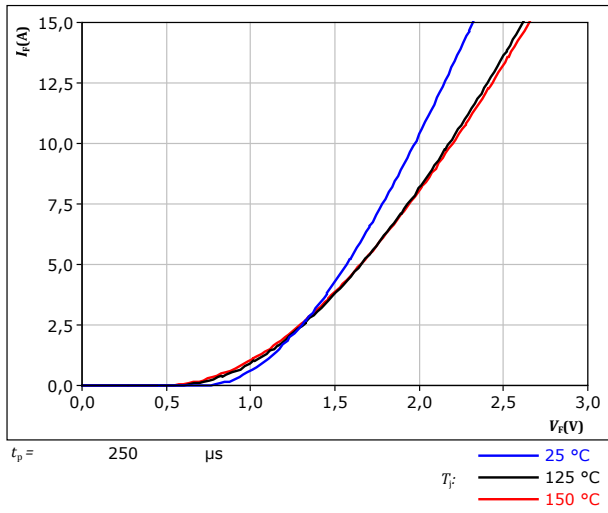
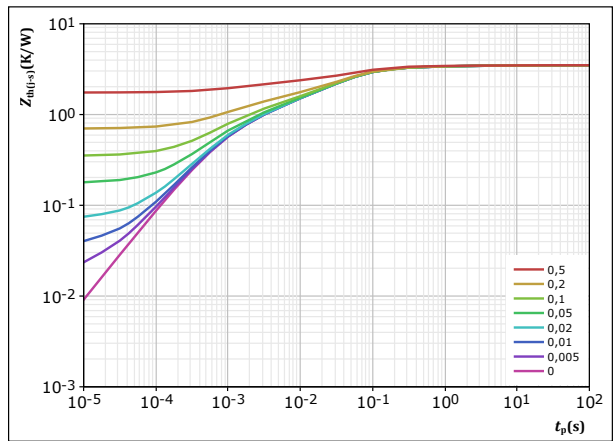

figure 14. FWD

Transient thermal impedance as a function of pulse width

$$Z_{th(j-s)} = f(t_p)$$



$D = \frac{t_p}{T}$   
 $R_{th(j-s)} = 3,495 \text{ K/W}$   
 FWD thermal model values

R (K/W)	$\tau$ (s)
8,03E-02	7,23E+00
2,34E-01	4,70E-01
1,33E+00	6,36E-02
7,92E-01	2,24E-02
5,71E-01	3,34E-03
4,85E-01	7,05E-04



### Rectifier Diode Characteristics

**figure 15.** Rectifier

Typical forward characteristics

$$I_F = f(V_F)$$

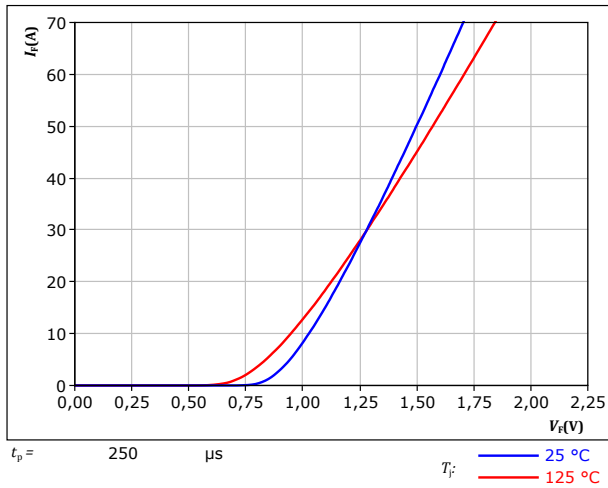

**figure 16.** Rectifier

Transient thermal impedance as a function of pulse width

$$Z_{th(j-s)} = f(t_p)$$

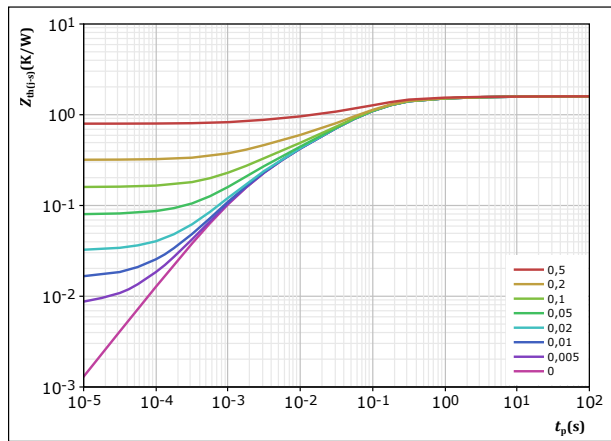

$D = \frac{t_p}{T}$   
 $R_{th(j-s)} = 1,594 \text{ K/W}$

Rectifier thermal model values

$R \text{ (K/W)}$	$\tau \text{ (s)}$
3,44E-02	9,66E+00
1,12E-01	1,22E+00
5,81E-01	1,45E-01
4,89E-01	5,05E-02
2,38E-01	9,26E-03
1,22E-01	1,79E-03
1,81E-02	7,88E-04



### Thermistor Characteristics

figure 17. Thermistor

Typical NTC characteristic as function of temperature

$$R_T = f(T)$$

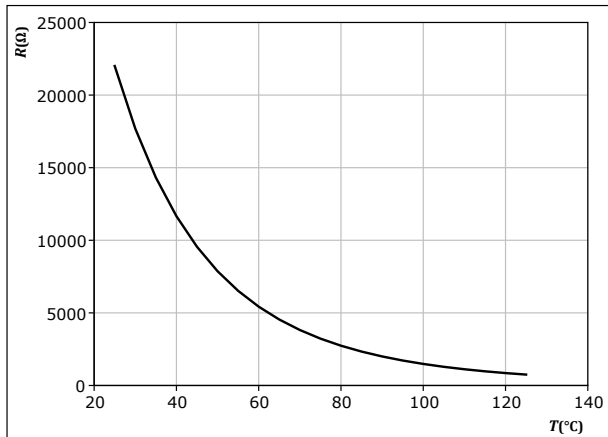





## Inverter Switching Characteristics

**figure 18.** IGBT

Typical switching energy losses as a function of collector current  
 $E = f(I_c)$

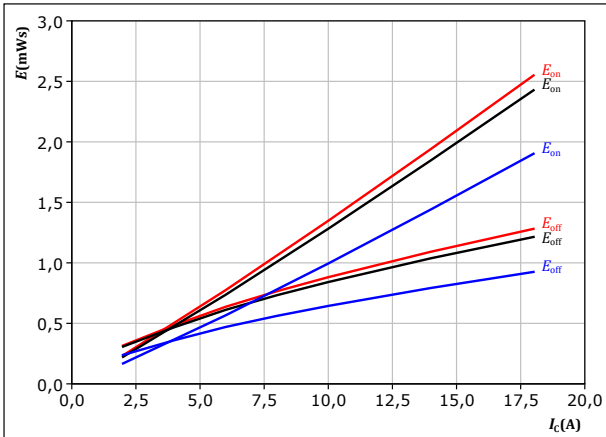

With an inductive load at  
 $V_{CE} = 600 \text{ V}$   
 $V_{GE} = \pm 15 \text{ V}$   
 $R_{gon} = 32 \ \Omega$   
 $R_{goff} = 32 \ \Omega$

$T_j$ : 25 °C (blue), 125 °C (black), 150 °C (red)

**figure 19.** IGBT

Typical switching energy losses as a function of gate resistor  
 $E = f(R_g)$

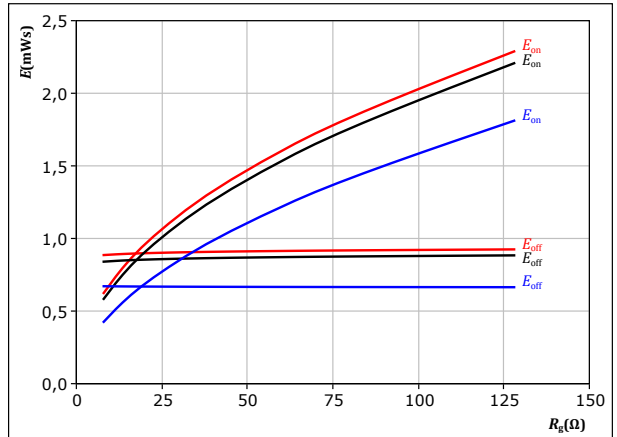

With an inductive load at  
 $V_{CE} = 600 \text{ V}$   
 $V_{GE} = \pm 15 \text{ V}$   
 $I_c = 10 \text{ A}$

$T_j$ : 25 °C (blue), 125 °C (black), 150 °C (red)

**figure 20.** FWD

Typical reverse recovered energy loss as a function of collector current  
 $E_{rec} = f(I_c)$

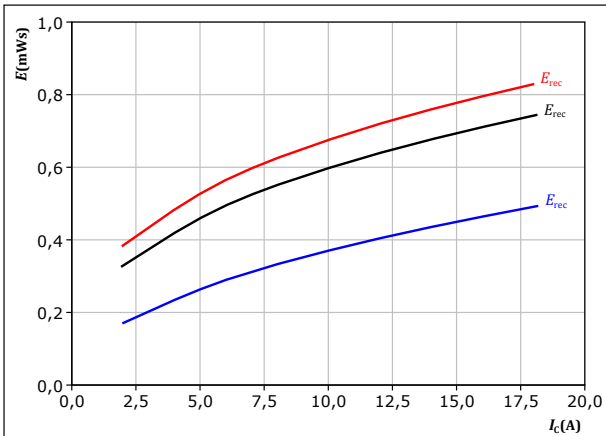

With an inductive load at  
 $V_{CE} = 600 \text{ V}$   
 $V_{GE} = \pm 15 \text{ V}$   
 $R_{gon} = 32 \ \Omega$

$T_j$ : 25 °C (blue), 125 °C (black), 150 °C (red)

**figure 21.** FWD

Typical reverse recovered energy loss as a function of gate resistor  
 $E_{rec} = f(R_g)$

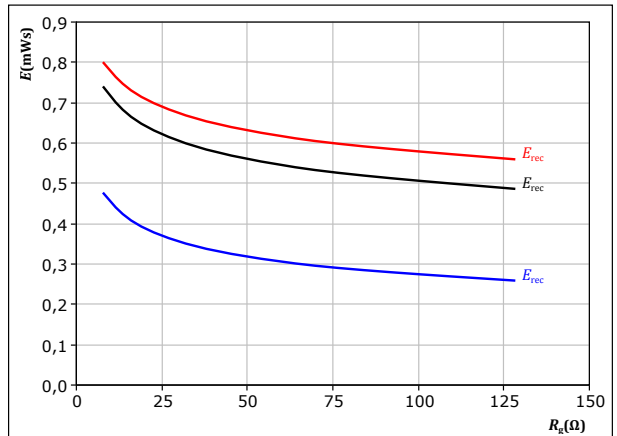

With an inductive load at  
 $V_{CE} = 600 \text{ V}$   
 $V_{GE} = \pm 15 \text{ V}$   
 $I_c = 10 \text{ A}$

$T_j$ : 25 °C (blue), 125 °C (black), 150 °C (red)



## Inverter Switching Characteristics

**figure 22.** IGBT

Typical switching times as a function of collector current  
 $t = f(I_c)$

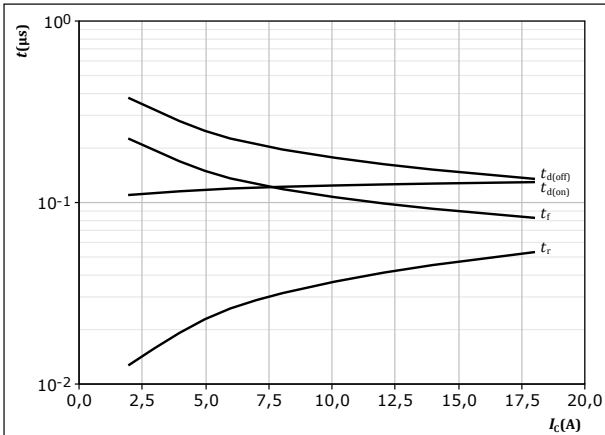

With an inductive load at  
 $T_j = 150 \text{ }^\circ\text{C}$   
 $V_{CE} = 600 \text{ V}$   
 $V_{GE} = \pm 15 \text{ V}$   
 $R_{g\text{on}} = 32 \text{ } \Omega$   
 $R_{g\text{off}} = 32 \text{ } \Omega$

**figure 23.** IGBT

Typical switching times as a function of gate resistor  
 $t = f(R_g)$

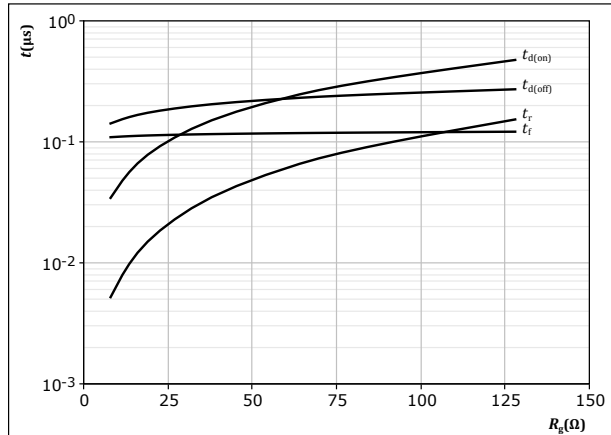

With an inductive load at  
 $T_j = 150 \text{ }^\circ\text{C}$   
 $V_{CE} = 600 \text{ V}$   
 $V_{GE} = \pm 15 \text{ V}$   
 $I_c = 10 \text{ A}$

**figure 24.** FWD

Typical reverse recovery time as a function of collector current  
 $t_{rr} = f(I_c)$

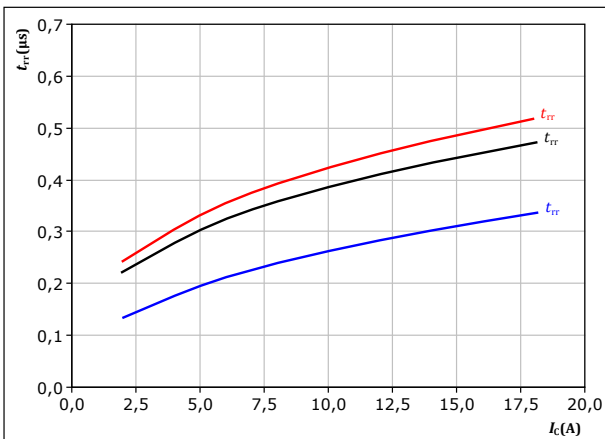

With an inductive load at  
 $V_{CE} = 600 \text{ V}$   
 $V_{GE} = \pm 15 \text{ V}$   
 $R_{g\text{on}} = 32 \text{ } \Omega$   
 $T_j:$  — 25 °C  
           — 125 °C  
           — 150 °C

**figure 25.** FWD

Typical reverse recovery time as a function of IGBT turn off gate resistor  
 $t_{rr} = f(R_{g\text{off}})$

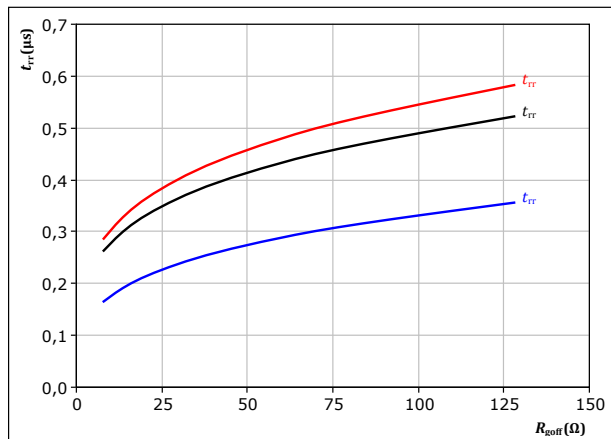

With an inductive load at  
 $V_{CE} = 600 \text{ V}$   
 $V_{GE} = \pm 15 \text{ V}$   
 $I_c = 10 \text{ A}$   
 $T_j:$  — 25 °C  
           — 125 °C  
           — 150 °C



## Inverter Switching Characteristics

**figure 26.** FWD

Typical recovered charge as a function of collector current

$$Q_r = f(I_c)$$

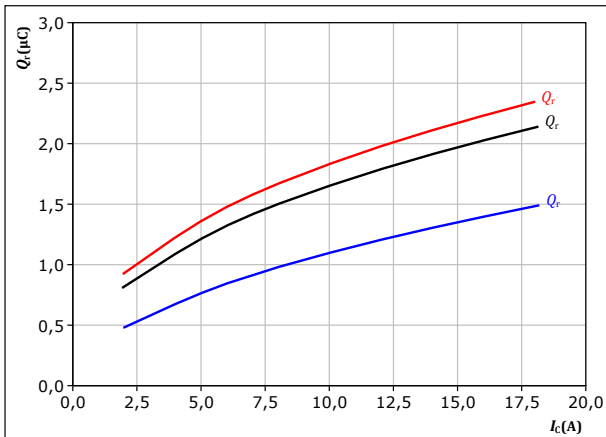

With an inductive load at

$V_{CE} =$	600	V	$T_j:$	— 25 °C
$V_{GE} =$	±15	V		— 125 °C
$R_{goff} =$	32	Ω		— 150 °C

**figure 28.** FWD

Typical peak reverse recovery current as a function of collector current

$$I_{RM} = f(I_c)$$

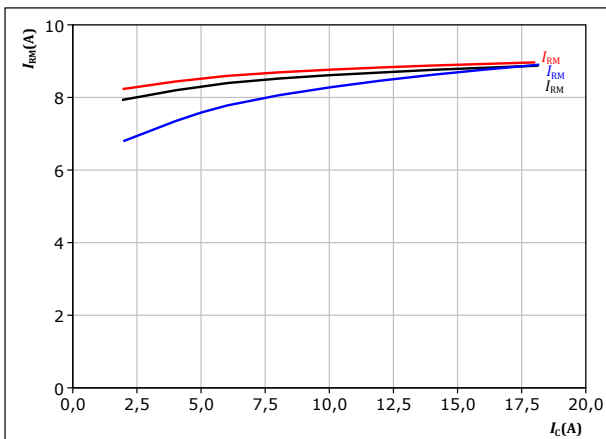

With an inductive load at

$V_{CE} =$	600	V	$T_j:$	— 25 °C
$V_{GE} =$	±15	V		— 125 °C
$R_{goff} =$	32	Ω		— 150 °C

**figure 27.** FWD

Typical recovered charge as a function of turn off gate resistor

$$Q_r = f(R_{goff})$$

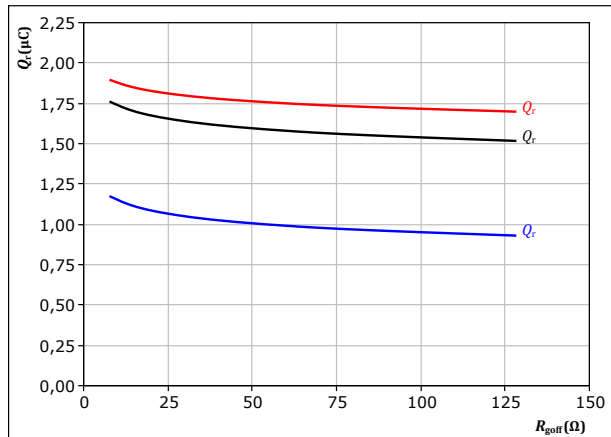

With an inductive load at

$V_{CE} =$	600	V	$T_j:$	— 25 °C
$V_{GE} =$	±15	V		— 125 °C
$I_c =$	10	A		— 150 °C

**figure 29.** FWD

Typical peak reverse recovery current as a function of turn off gate resistor

$$I_{RM} = f(R_{goff})$$

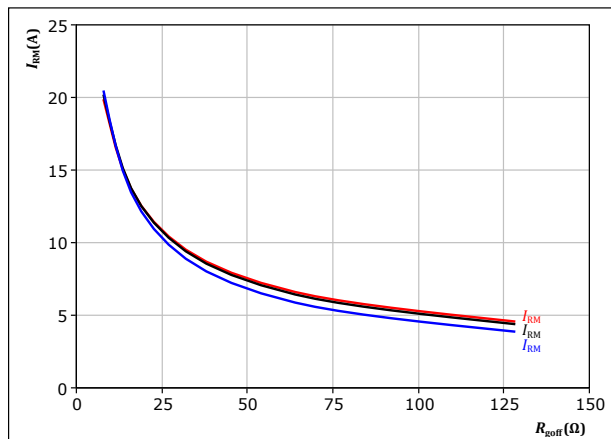

With an inductive load at

$V_{CE} =$	600	V	$T_j:$	— 25 °C
$V_{GE} =$	±15	V		— 125 °C
$I_c =$	10	A		— 150 °C



## Inverter Switching Characteristics

**figure 30.** FWD

Typical rate of fall of forward and reverse recovery current as a function of collector current  
 $di_f/dt, di_{rr}/dt = f(I_c)$

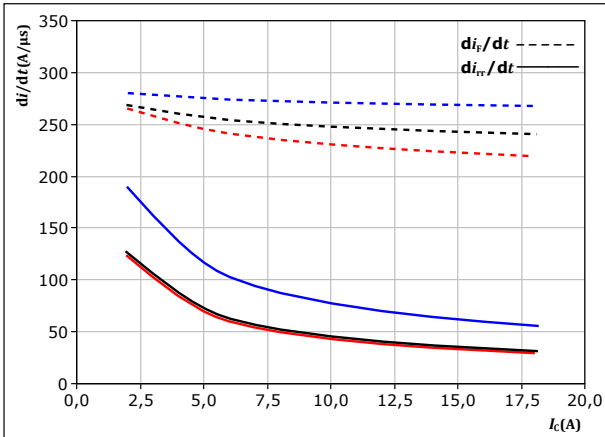

With an inductive load at

$V_{CE} = 600 \text{ V}$   
 $V_{GE} = \pm 15 \text{ V}$   
 $R_{goff} = 32 \text{ } \Omega$

$T_j$ : — 25 °C  
 — 125 °C  
 — 150 °C

**figure 31.** FWD

Typical rate of fall of forward and reverse recovery current as a function of turn off gate resistor  
 $di_f/dt, di_{rr}/dt = f(R_{goff})$

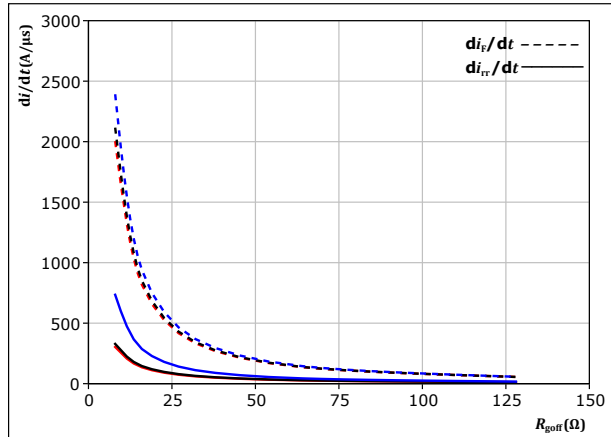

With an inductive load at

$V_{CE} = 600 \text{ V}$   
 $V_{GE} = \pm 15 \text{ V}$   
 $I_c = 10 \text{ A}$

$T_j$ : — 25 °C  
 — 125 °C  
 — 150 °C

**figure 32.** IGBT

Reverse bias safe operating area

$I_c = f(V_{CE})$

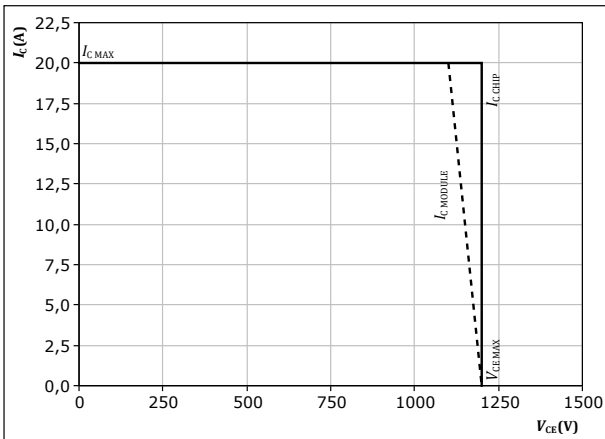

At  $T_j = 150 \text{ } ^\circ\text{C}$   
 $R_{goff} = 32 \text{ } \Omega$   
 $R_{goff} = 32 \text{ } \Omega$



## Brake Switching Characteristics

**figure 33.** IGBT

Typical switching energy losses as a function of collector current

$$E = f(I_c)$$

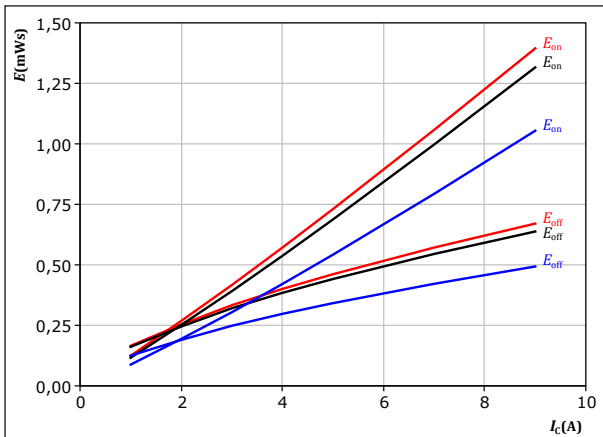

With an inductive load at

$V_{CE} = 600 \text{ V}$   
 $V_{GE} = 0/15 \text{ V}$   
 $R_{gon} = 64 \ \Omega$   
 $R_{goff} = 64 \ \Omega$

$T_j$ : — 25 °C  
 — 125 °C  
 — 150 °C

**figure 34.** IGBT

Typical switching energy losses as a function of gate resistor

$$E = f(R_g)$$

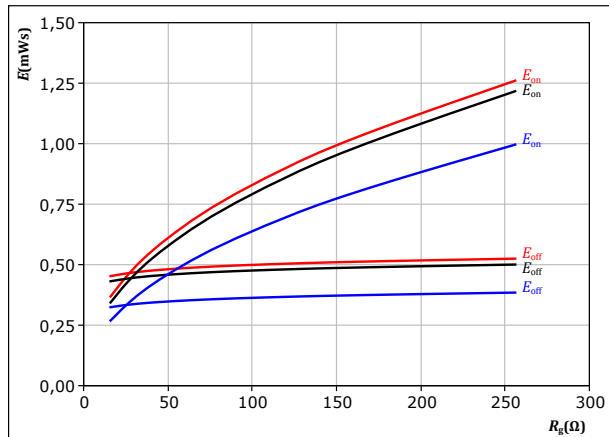

With an inductive load at

$V_{CE} = 600 \text{ V}$   
 $V_{GE} = 0/15 \text{ V}$   
 $I_c = 5 \text{ A}$

$T_j$ : — 25 °C  
 — 125 °C  
 — 150 °C

**figure 35.** FWD

Typical reverse recovered energy loss as a function of collector current

$$E_{rec} = f(I_c)$$

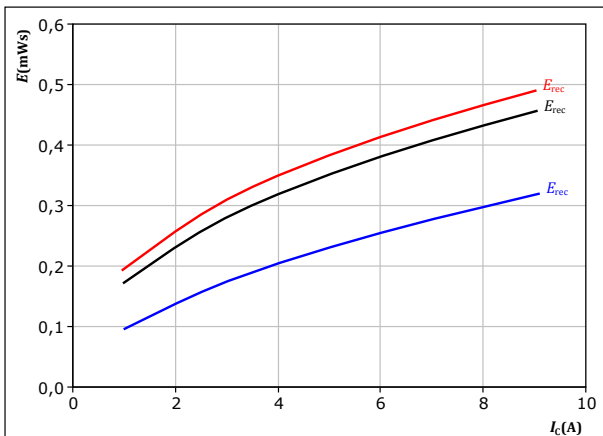

With an inductive load at

$V_{CE} = 600 \text{ V}$   
 $V_{GE} = 0/15 \text{ V}$   
 $R_{gon} = 64 \ \Omega$

$T_j$ : — 25 °C  
 — 125 °C  
 — 150 °C

**figure 36.** FWD

Typical reverse recovered energy loss as a function of gate resistor

$$E_{rec} = f(R_g)$$

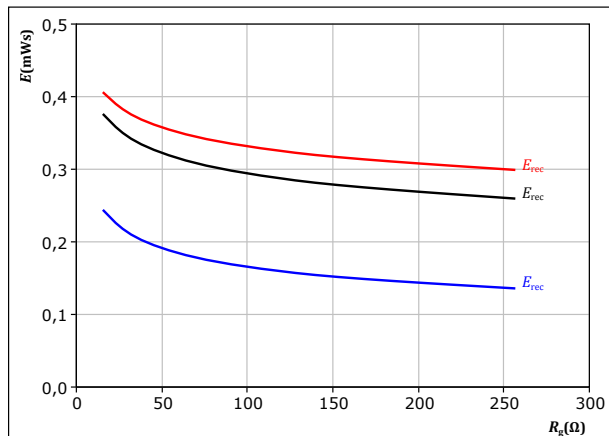

With an inductive load at

$V_{CE} = 600 \text{ V}$   
 $V_{GE} = 0/15 \text{ V}$   
 $I_c = 5 \text{ A}$

$T_j$ : — 25 °C  
 — 125 °C  
 — 150 °C



## Brake Switching Characteristics

**figure 37.** IGBT

Typical switching times as a function of collector current  
 $t = f(I_c)$

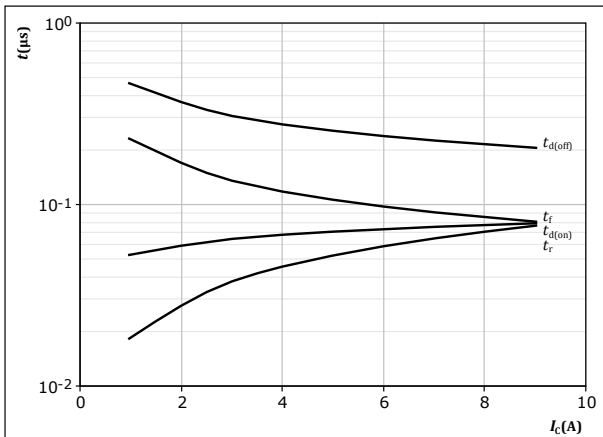

With an inductive load at  
 $T_j = 150 \text{ } ^\circ\text{C}$   
 $V_{CE} = 600 \text{ V}$   
 $V_{GE} = 0/15 \text{ V}$   
 $R_{g(on)} = 64 \text{ } \Omega$   
 $R_{g(off)} = 64 \text{ } \Omega$

**figure 38.** IGBT

Typical switching times as a function of gate resistor  
 $t = f(R_g)$

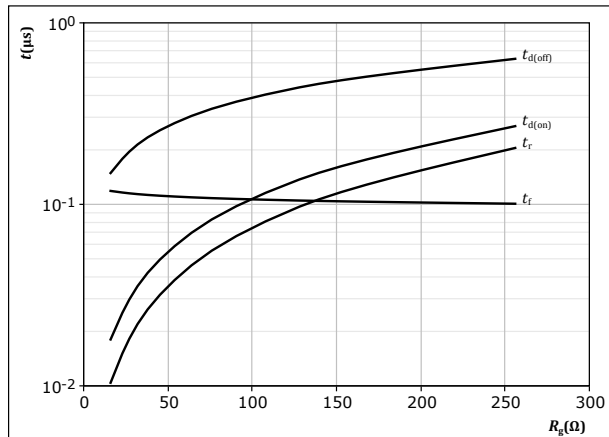

With an inductive load at  
 $T_j = 150 \text{ } ^\circ\text{C}$   
 $V_{CE} = 600 \text{ V}$   
 $V_{GE} = 0/15 \text{ V}$   
 $I_c = 5 \text{ A}$

**figure 39.** FWD

Typical reverse recovery time as a function of collector current  
 $t_{rr} = f(I_c)$

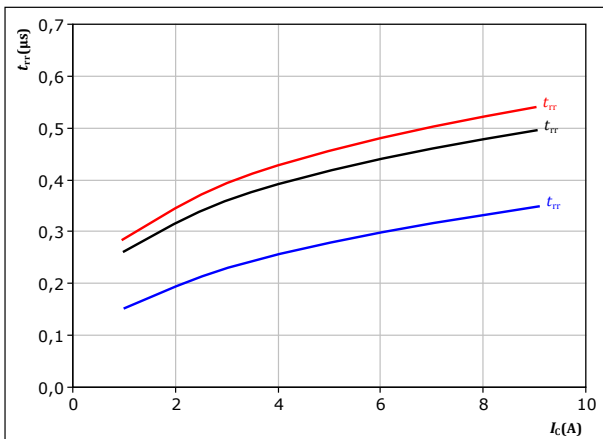

With an inductive load at  
 $V_{CE} = 600 \text{ V}$   
 $V_{GE} = 0/15 \text{ V}$   
 $R_{g(on)} = 64 \text{ } \Omega$   
 $T_j: \text{ } \text{---} 25 \text{ } ^\circ\text{C}$   
 $\text{---} 125 \text{ } ^\circ\text{C}$   
 $\text{---} 150 \text{ } ^\circ\text{C}$

**figure 40.** FWD

Typical reverse recovery time as a function of IGBT turn off gate resistor  
 $t_{rr} = f(R_{g(off)})$

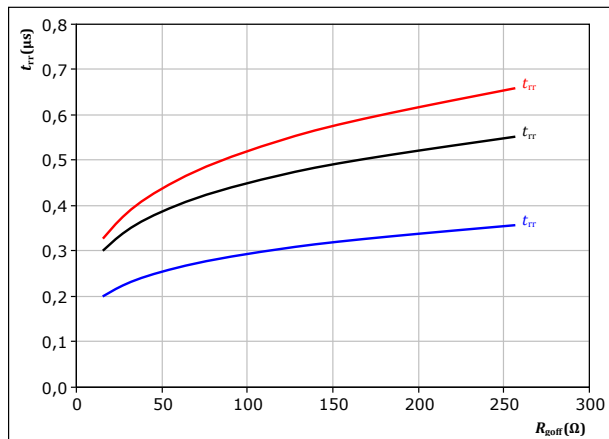

With an inductive load at  
 $V_{CE} = 600 \text{ V}$   
 $V_{GE} = 0/15 \text{ V}$   
 $I_c = 5 \text{ A}$   
 $T_j: \text{ } \text{---} 25 \text{ } ^\circ\text{C}$   
 $\text{---} 125 \text{ } ^\circ\text{C}$   
 $\text{---} 150 \text{ } ^\circ\text{C}$



## Brake Switching Characteristics

figure 41. FWD

Typical recovered charge as a function of collector current

$$Q_r = f(I_c)$$

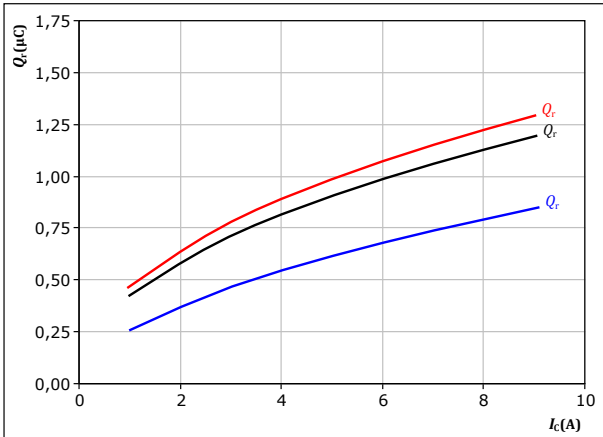

With an inductive load at

$V_{CE} = 600 \text{ V}$   
 $V_{GE} = 0/15 \text{ V}$   
 $R_{goff} = 64 \text{ } \Omega$

$T_j$ : — 25 °C  
— 125 °C  
— 150 °C

figure 42. FWD

Typical recovered charge as a function of turn off gate resistor

$$Q_r = f(R_{goff})$$

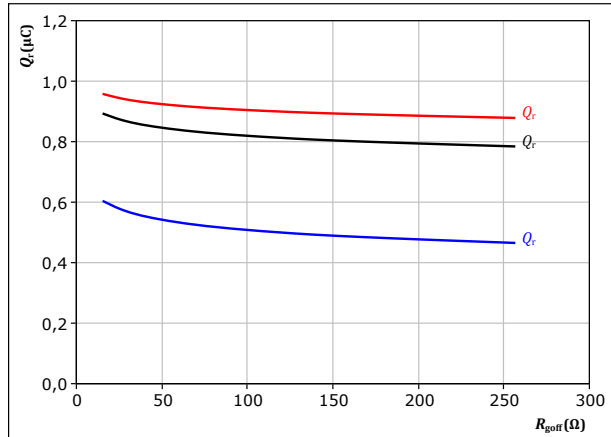

With an inductive load at

$V_{CE} = 600 \text{ V}$   
 $V_{GE} = 0/15 \text{ V}$   
 $I_c = 5 \text{ A}$

$T_j$ : — 25 °C  
— 125 °C  
— 150 °C

figure 43. FWD

Typical peak reverse recovery current as a function of collector current

$$I_{RM} = f(I_c)$$

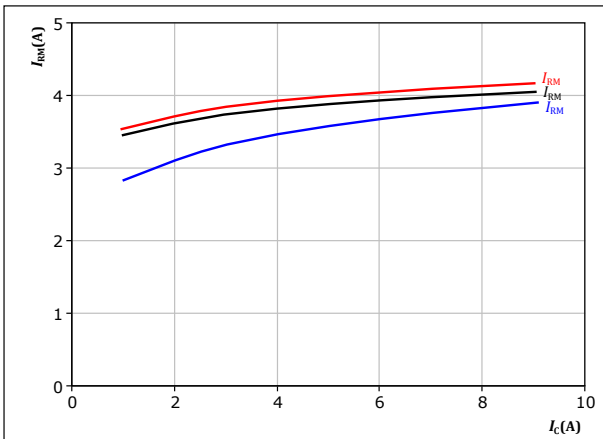

With an inductive load at

$V_{CE} = 600 \text{ V}$   
 $V_{GE} = 0/15 \text{ V}$   
 $R_{goff} = 64 \text{ } \Omega$

$T_j$ : — 25 °C  
— 125 °C  
— 150 °C

figure 44. FWD

Typical peak reverse recovery current as a function of turn off gate resistor

$$I_{RM} = f(R_{goff})$$

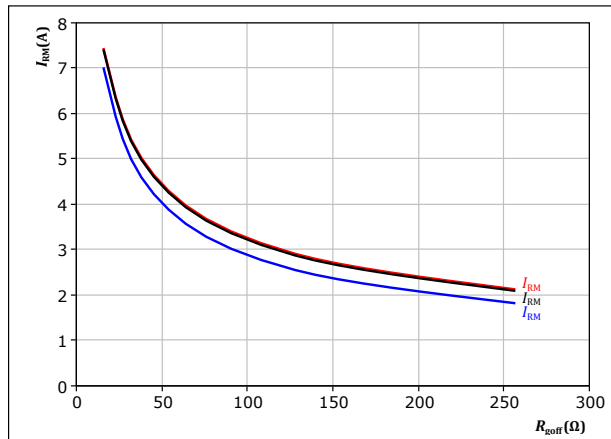

With an inductive load at

$V_{CE} = 600 \text{ V}$   
 $V_{GE} = 0/15 \text{ V}$   
 $I_c = 5 \text{ A}$

$T_j$ : — 25 °C  
— 125 °C  
— 150 °C



### Brake Switching Characteristics

**figure 45.** FWD

Typical rate of fall of forward and reverse recovery current as a function of collector current  
 $di_f/dt, di_r/dt = f(I_c)$

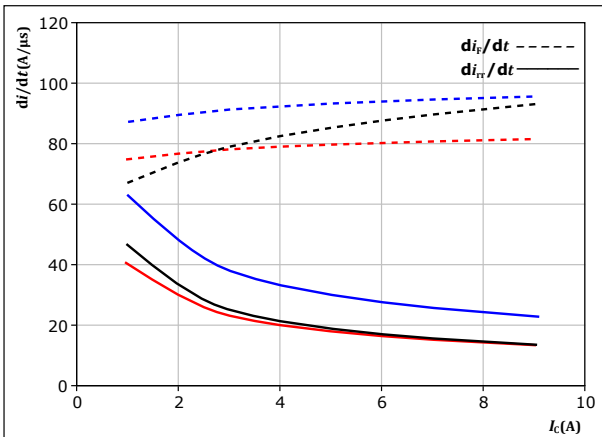

With an inductive load at  
 $V_{CE} = 600 \text{ V}$   
 $V_{GE} = 0/15 \text{ V}$   
 $R_{goff} = 64 \text{ } \Omega$

$T_j$ :  
— 25 °C  
— 125 °C  
— 150 °C

**figure 46.** FWD

Typical rate of fall of forward and reverse recovery current as a function of turn off gate resistor  
 $di_f/dt, di_r/dt = f(R_{goff})$

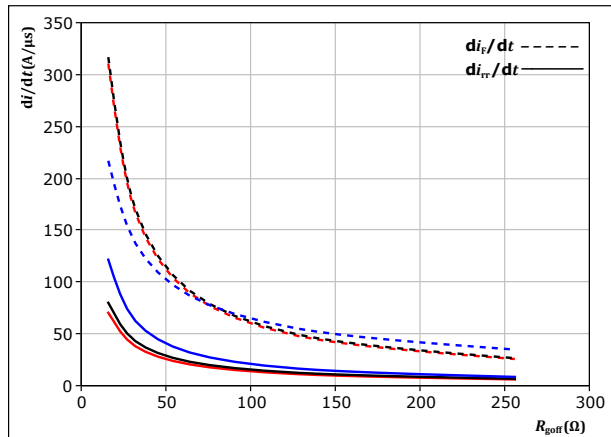

With an inductive load at  
 $V_{CE} = 600 \text{ V}$   
 $V_{GE} = 0/15 \text{ V}$   
 $I_c = 5 \text{ A}$

$T_j$ :  
— 25 °C  
— 125 °C  
— 150 °C

**figure 47.** IGBT

Reverse bias safe operating area  
 $I_c = f(V_{CE})$

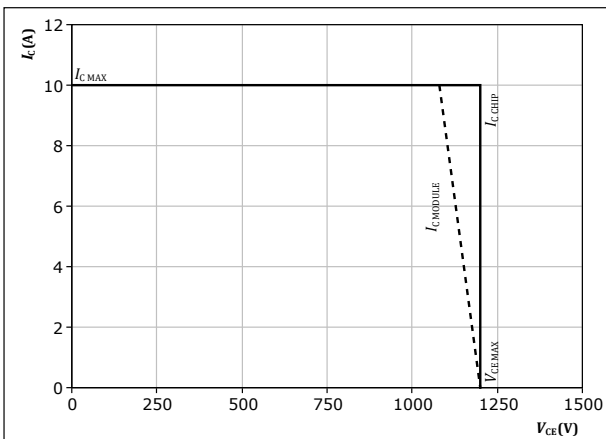

At  $T_j = 150 \text{ } ^\circ\text{C}$   
 $R_{goff} = 64 \text{ } \Omega$   
 $R_{goff} = 64 \text{ } \Omega$





## Switching Definitions

figure 48. IGBT

Turn-off Switching Waveforms & definition of  $t_{doff}$ ,  $t_{Eoff}$  ( $t_{Eoff}$  = integrating time for  $E_{off}$ )

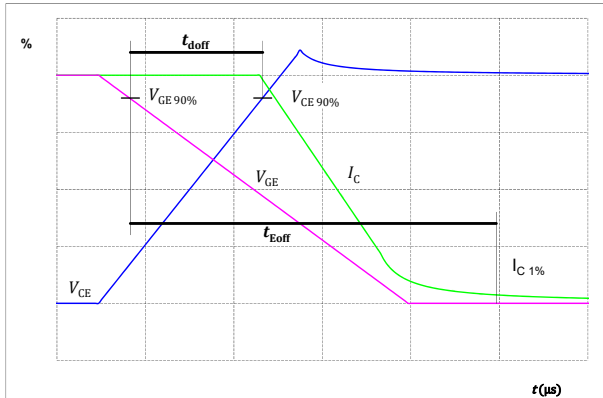

figure 49. IGBT

Turn-on Switching Waveforms & definition of  $t_{don}$ ,  $t_{Eon}$  ( $t_{Eon}$  = integrating time for  $E_{on}$ )



figure 50. IGBT

Turn-off Switching Waveforms & definition of  $t_f$

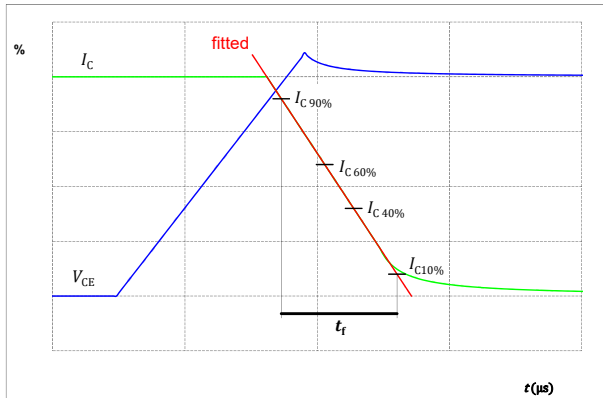
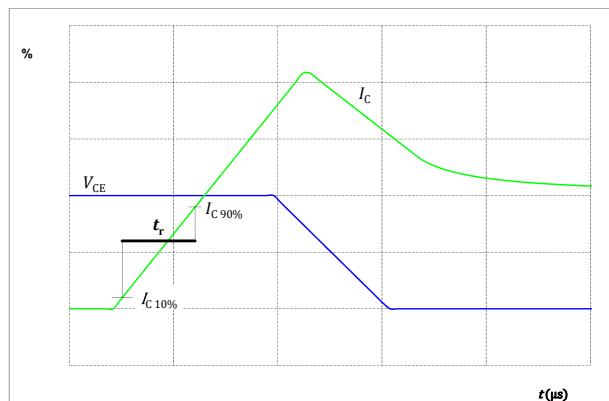

figure 51. IGBT

Turn-on Switching Waveforms & definition of  $t_r$





### Switching Definitions

figure 52. FWD

Turn-off Switching Waveforms & definition of  $t_{rr}$

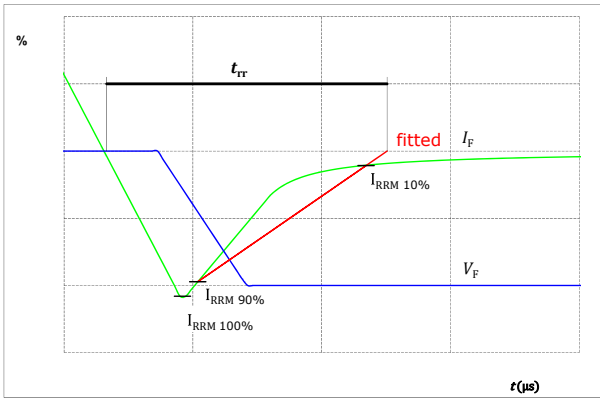
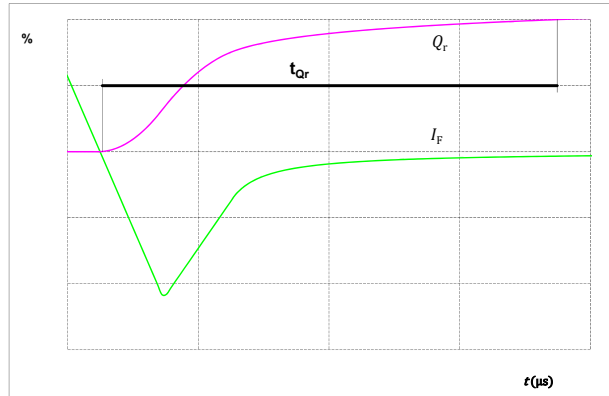

figure 53. FWD

Turn-on Switching Waveforms & definition of  $t_{Qr}$  ( $t_{Qr}$  = integrating time for  $Q_r$ )





Ordering Code	
<b>Version</b>	<b>Ordering Code</b>
Without thermal paste	10-F012PMA010M7-P849A29
With thermal paste (5,2 W/mK, PTM6000HV)	10-F012PMA010M7-P849A29-/7/
With thermal paste (3,4 W/mK, PSX-P7)	10-F012PMA010M7-P849A29-/3/

Marking						
	<b>Text</b>	<b>Name</b>	<b>Date code</b>	<b>UL &amp; VIN</b>	<b>Lot</b>	<b>Serial</b>
		NN-NNNNNNNNNNNNNN- TTTTIVV	WWYY	UL VIN	LLLLL	SSSS
	<b>Datamatrix</b>	<b>Type&amp;Ver</b>	<b>Lot number</b>	<b>Serial</b>	<b>Date code</b>	
		TTTTIVV	LLLLL	SSSS	WWYY	

**Outline**

Pin table [mm]			
Pin	X	Y	Function
1	25,5	2,7	Therm1
2	25,5	0	Therm2
3	22,8	0	DC-Rect
4	20,1	0	G27
5	16,2	0	DC-Br
6	13,5	0	G15
7	10,8	0	DC-3
8	8,1	0	G13
9	5,4	0	DC-2
10	2,7	0	G11
11	0	0	DC-1
12	0	19,8	G12
13	0	22,5	Ph1
14	7,5	19,8	G14
15	7,5	22,5	Ph2
16	15	19,8	G16
17	15	22,5	Ph3
18	22,8	22,5	DC+Inv
19	25,5	22,5	DC+Rect
20	33,5	22,5	Br
21	33,5	15	ACIn1
22	33,5	7,5	ACIn2
23	33,5	0	ACIn3

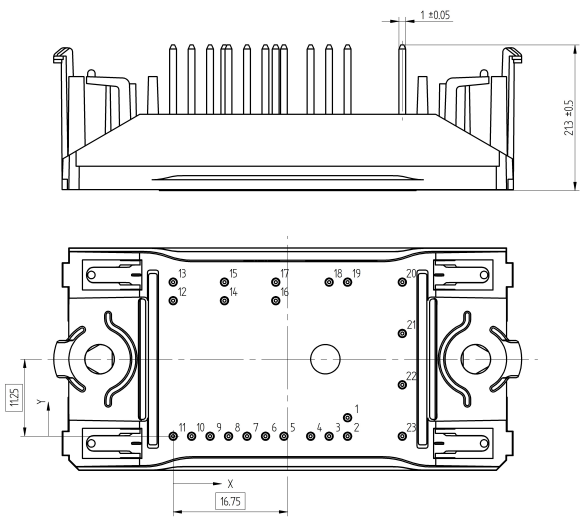

Tolerance of pinpositions: ±0,5mm at the end of pins  
Dimension of coordinate axis is only offset without tolerance



Vincotech

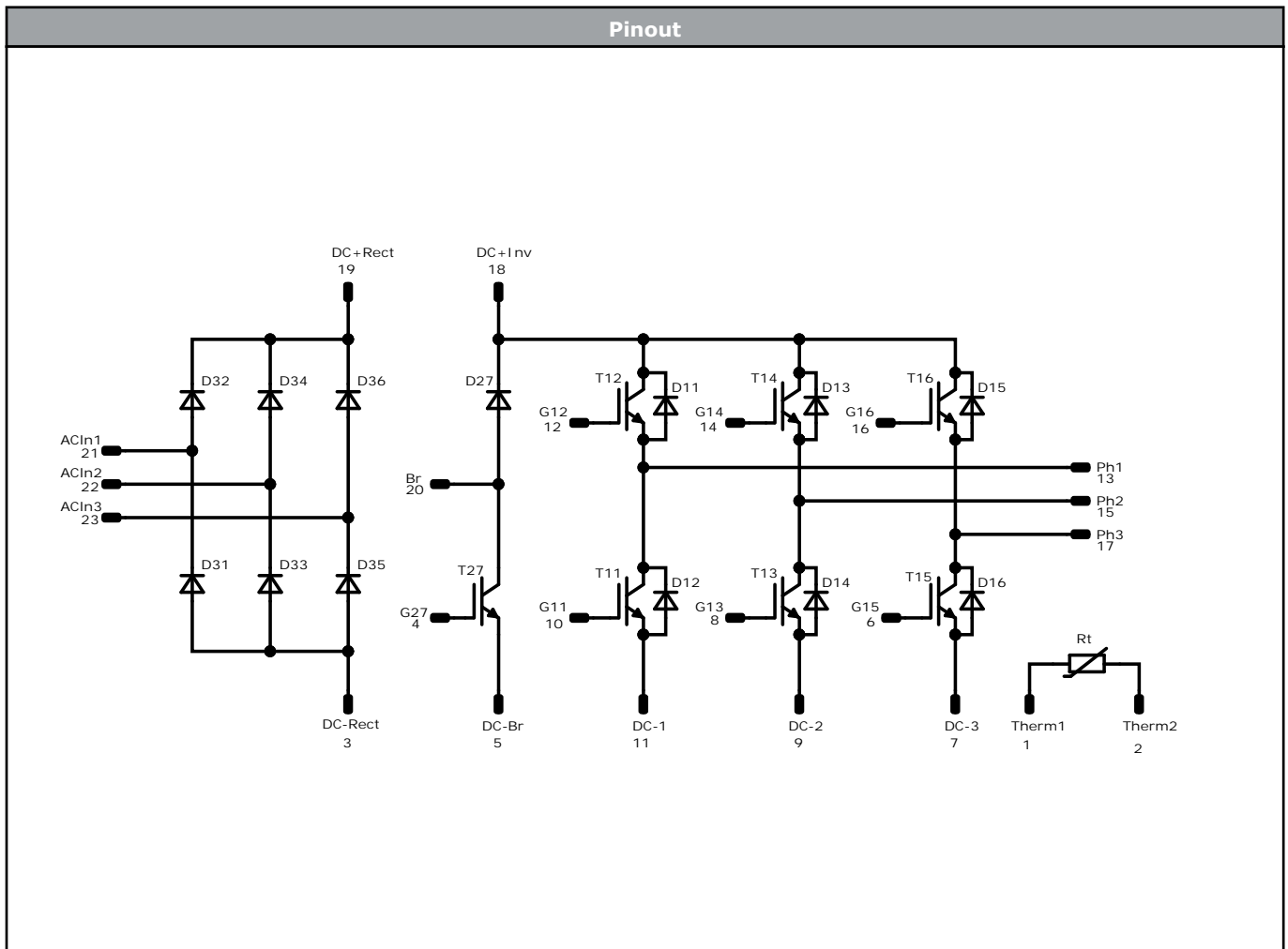

Identification					
ID	Component	Voltage	Current	Function	Comment
T11, T12, T13, T14, T15, T16	IGBT	1200 V	10 A	Inverter Switch	
D11, D12, D13, D14, D15, D16	FWD	1200 V	10 A	Inverter Diode	
T27	IGBT	1200 V	5 A	Brake Switch	
D27	FWD	1200 V	5 A	Brake Diode	
D31, D32, D33, D34, D35, D36	Rectifier	1600 V	25 A	Rectifier Diode	
Rt	NTC			Thermistor	



Packaging instruction				
Standard packaging quantity (SPQ) 135	>SPQ	Standard	<SPQ	Sample

Handling instruction
Handling instructions for <i>flow 0</i> packages see vincotech.com website.

Package data
Package data for <i>flow 0</i> packages see vincotech.com website.

Vincotech thermistor reference
See Vincotech thermistor reference table at vincotech.com website.

UL recognition and file number
This device is certified according to UL 1557 standard, UL file number E192116. For more information see vincotech.com website. 

Document No.:	Date:	Modification:	Pages
10-F012PMA010M7-P849A29-D5-14	30 Sep. 2021	New Datasheet format, module is unchanged Correct Thermal values of Inverter Diode Separate datasheet for pressfit pin version	

**DISCLAIMER**

The information, specifications, procedures, methods and recommendations herein (together "information") are presented by Vincotech to reader in good faith, are believed to be accurate and reliable, but may well be incomplete and/or not applicable to all conditions or situations that may exist or occur. Vincotech reserves the right to make any changes without further notice to any products to improve reliability, function or design. No representation, guarantee or warranty is made to reader as to the accuracy, reliability or completeness of said information or that the application or use of any of the same will avoid hazards, accidents, losses, damages or injury of any kind to persons or property or that the same will not infringe third parties rights or give desired results. It is reader's sole responsibility to test and determine the suitability of the information and the product for reader's intended use.

**LIFE SUPPORT POLICY**

Vincotech products are not authorised for use as critical components in life support devices or systems without the express written approval of Vincotech.

As used herein:

1. Life support devices or systems are devices or systems which, (a) are intended for surgical implant into the body, or (b) support or sustain life, or (c) whose failure to perform when properly used in accordance with instructions for use provided in labelling can be reasonably expected to result in significant injury to the user.
2. A critical component is any component of a life support device or system whose failure to perform can be reasonably expected to cause the failure of the life support device or system, or to affect its safety or effectiveness.

单击下面可查看定价，库存，交付和生命周期等信息

[>>Vincotech\(威科\)](#)