

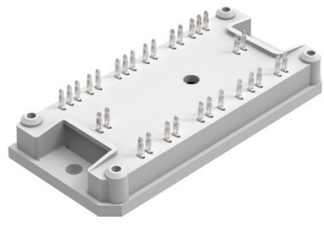
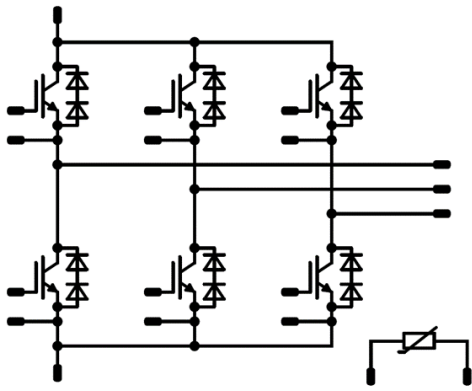

Vincotech

flowPACK 1	1200 V / 50 A
<div style="border: 1px solid black; padding: 5px; margin-bottom: 10px;"> <p style="text-align: center; background-color: #cccccc; margin: 0;">Features</p> <ul style="list-style-type: none"> High speed IGBT4 Tandem diodes for improved thermal performance Integrated thermal sensor </div> <div style="border: 1px solid black; padding: 5px; margin-bottom: 10px;"> <p style="text-align: center; background-color: #cccccc; margin: 0;">Target applications</p> <ul style="list-style-type: none"> Embedded Drives Industrial Drives </div> <div style="border: 1px solid black; padding: 5px;"> <p style="text-align: center; background-color: #cccccc; margin: 0;">Types</p> <ul style="list-style-type: none"> 10-PY126TA050SH-L828F68Y </div>	<div style="border: 1px solid black; padding: 5px; margin-bottom: 10px;"> <p style="text-align: center; background-color: #cccccc; margin: 0;">flow 1 12mm housing</p>  </div> <div style="border: 1px solid black; padding: 5px;"> <p style="text-align: center; background-color: #cccccc; margin: 0;">Schematic</p>  </div>

Maximum Ratings

$T_j = 25\text{ }^\circ\text{C}$, unless otherwise specified

Parameter	Symbol	Condition	Value	Unit
Inverter Switch				
Collector-emitter voltage	V_{CES}		1200	V
Collector current	I_C	$T_j = T_{jmax}$ $T_s = 80\text{ }^\circ\text{C}$	48	A
Repetitive peak collector current	I_{CRM}	t_p limited by T_{jmax}	150	A
Total power dissipation	P_{tot}	$T_j = T_{jmax}$ $T_s = 80\text{ }^\circ\text{C}$	122	W
Gate-emitter voltage	V_{GES}		± 20	V
Short circuit ratings	t_{SC}	$V_{GE} = 15\text{ V}$ $V_{CE} = 800\text{ V}$ $T_j = 150\text{ }^\circ\text{C}$	10	μs
Maximum junction temperature	T_{jmax}		175	$^\circ\text{C}$



Vincotech

Maximum Ratings

$T_j = 25\text{ °C}$, unless otherwise specified

Parameter	Symbol	Condition	Value	Unit
Inverter Diode				
Peak repetitive reverse voltage	V_{RRM}		1300	V
Continuous (direct) forward current	I_F	$T_j = T_{jmax}$ $T_s = 80\text{ °C}$	38	A
Repetitive peak forward current	I_{FRM}		100	A
Total power dissipation	P_{tot}	$T_j = T_{jmax}$ $T_s = 80\text{ °C}$	102	W
Maximum junction temperature	T_{jmax}		175	°C

Module Properties

Thermal Properties

Storage temperature	T_{stg}		-40...+125	°C
Operation temperature under switching condition	T_{top}		-40...(T _{jmax} - 25)	°C

Isolation Properties

Isolation voltage	V_{isol}	DC Test Voltage* $t_p = 2\text{ s}$	6000	V
		AC Voltage $t_p = 1\text{ min}$	2500	V
Creepage distance			min. 12,7	mm
Clearance			7,9	mm
Comparative Tracking Index	CTI		> 200	

*100 % tested in production



Vincotech

Characteristic Values

Parameter	Symbol	Conditions					Value			Unit
		V_{GE} [V] V_{GS} [V]	V_{CE} [V] V_{DS} [V] V_F [V]	I_C [A] I_D [A] I_F [A]	T_j [°C]	Min	Typ	Max		

Inverter Switch

Static

Gate-emitter threshold voltage	$V_{GE(th)}$	$V_{GE} = V_{CE}$			0,0017	25	5,3	5,8	6,3	V
Collector-emitter saturation voltage	V_{CEsat}		15		50	25 125 150	1,78	2,04 2,38 2,46	2,42	V
Collector-emitter cut-off current	I_{CES}		0	1200		25			1	μA
Gate-emitter leakage current	I_{GES}		20	0		25			120	nA
Internal gate resistance	r_g							4		Ω
Input capacitance	C_{ies}	$f = 1 \text{ Mhz}$	0	25		25		2770		pF
Reverse transfer capacitance	C_{res}							160		

Thermal

Thermal resistance junction to sink	$R_{th(j-s)}$	$\lambda_{paste} = 3,4 \text{ W/mK}$ (PSX)						0,78		K/W
-------------------------------------	---------------	---	--	--	--	--	--	------	--	-----

Dynamic

Turn-on delay time	$t_{d(on)}$	$R_{gon} = 8 \Omega$ $R_{goff} = 8 \Omega$	± 15	600	50	25		92		ns
Rise time	t_r					125		95		
						150		96		
						25		20		
Turn-off delay time	$t_{d(off)}$					125		24		
						150		25		
						25		185		
Fall time	t_f	125		236						
		150		252						
		25		55						
Turn-on energy (per pulse)	E_{on}	$Q_{tFWD} = 1,6 \mu\text{C}$ $Q_{tFWD} = 3 \mu\text{C}$ $Q_{tFWD} = 3,5 \mu\text{C}$				25		2,052		mWs
						125		2,898		
						150		3,130		
Turn-off energy (per pulse)	E_{off}					25		2,008		
						125		3,178		
						150		3,525		



Vincotech

Characteristic Values

Parameter	Symbol	Conditions					Value			Unit
		V_{GE} [V]	V_{CE} [V]	I_C [A]	T_j [°C]	Min	Typ	Max		

Inverter Diode

Static

Parameter	Symbol	V_{GE} [V]	V_{CE} [V]	I_C [A]	T_j [°C]	Min	Typ	Max	Unit
Forward voltage	V_F			50	25 125 150		3,23 3,09 3,03	3,54	V
Reverse leakage current	I_R		1300		25			2,65	μA

Thermal

Parameter	Symbol	Conditions	Value	Unit
Thermal resistance junction to sink	$R_{th(j-s)}$	$\lambda_{paste} = 3,4$ W/mK (PSX)	0,93	K/W

Dynamic

Parameter	Symbol	Conditions	Value	Unit	
Peak recovery current	I_{RRM}		25 125 150	32 40 43 A	
Reverse recovery time	t_{rr}		25 125 150	109 149 167 ns	
Recovered charge	Q_r	$di/dt = 2600$ A/μs $di/dt = 2009$ A/μs $di/dt = 3015$ A/μs	±15 600 50	25 125 150	1,606 3,039 3,547 μC
Reverse recovered energy	E_{rec}		25 125 150	0,516 0,987 1,172 mWs	
Peak rate of fall of recovery current	$(di_{rr}/dt)_{max}$		25 125 150	1844 156 171 A/μs	

Thermistor

Parameter	Symbol	Conditions	Value	Unit
Rated resistance	R		25	22 kΩ
Deviation of R_{100}	$\Delta_{R/R}$	$R_{100} = 1484$ Ω	100	-5 5 %
Power dissipation	P		25	5 mW
Power dissipation constant			25	1,5 mW/K
B-value	$B_{(25/50)}$	Tol. ±1 %	25	3962 K
B-value	$B_{(25/100)}$	Tol. ±1 %	25	4000 K
Vincotech NTC Reference				I



Inverter Switch Characteristics

figure 1. IGBT

Typical output characteristics

$I_C = f(V_{CE})$

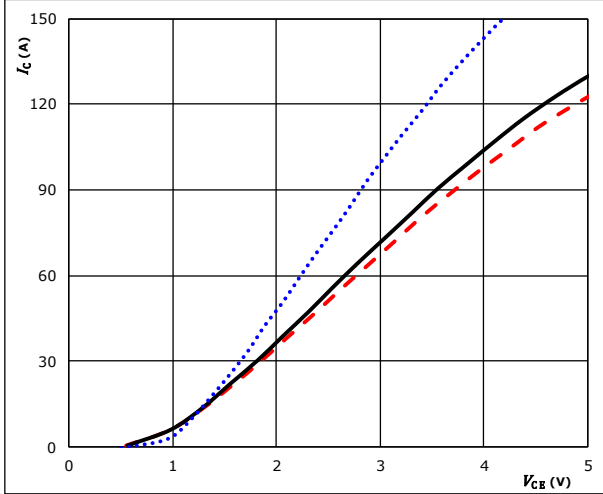

$t_p = 250 \mu s$
 $V_{GE} = 15 V$
 $T_j: 25 \text{ }^\circ C$ (dotted blue)
 $125 \text{ }^\circ C$ (solid black)
 $150 \text{ }^\circ C$ (dashed red)

figure 2. IGBT

Typical output characteristics

$I_C = f(V_{CE})$

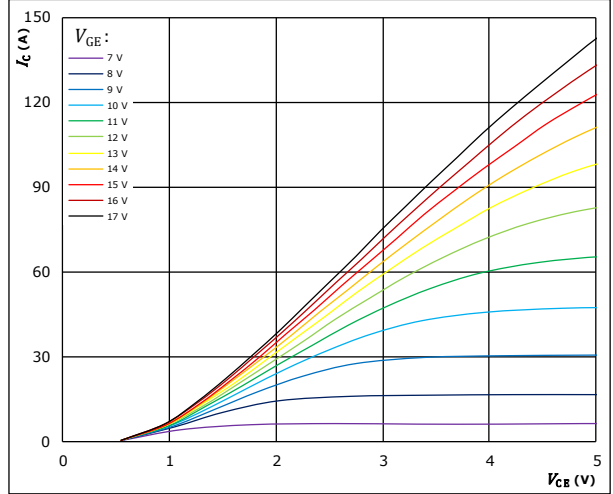

$t_p = 250 \mu s$
 $T_j = 150 \text{ }^\circ C$
 V_{GE} from 7 V to 17 V in steps of 1 V

figure 3. IGBT

Typical transfer characteristics

$I_C = f(V_{GE})$

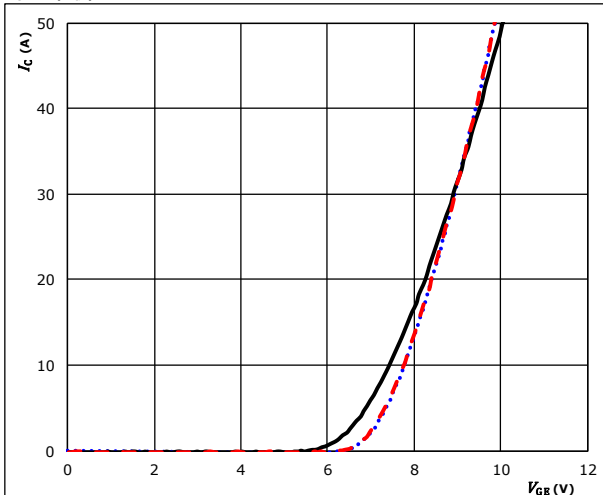

$t_p = 100 \mu s$
 $V_{CE} = 10 V$
 $T_j: 25 \text{ }^\circ C$ (dotted blue)
 $125 \text{ }^\circ C$ (solid black)
 $150 \text{ }^\circ C$ (dashed red)

figure 4. IGBT

Transient thermal impedance as function of pulse duration

$Z_{th(j-s)} = f(t_p)$

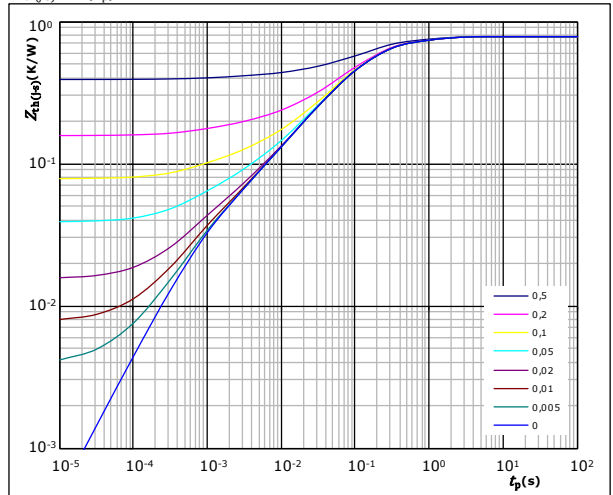

$D = t_p / T$
 $R_{th(j-s)} = 0,78 \text{ K/W}$
 IGBT thermal model values

R (K/W)	τ (s)
1,24E-01	9,17E-01
3,94E-01	1,41E-01
1,70E-01	4,90E-02
6,32E-02	9,18E-03
3,04E-02	9,28E-04



Vincotech

Inverter Switch Characteristics

figure 5. IGBT

Safe operating area

$$I_C = f(V_{CE})$$

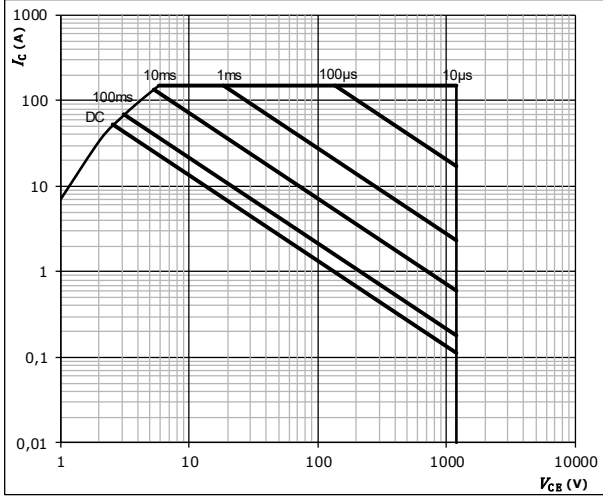

$D =$ single pulse
 $T_s =$ 80 °C
 $V_{GE} =$ ±15 V
 $T_j = T_{max}$



Vincotech

Inverter Diode Characteristics

figure 1. FWD

Typical forward characteristics

$$I_F = f(V_F)$$

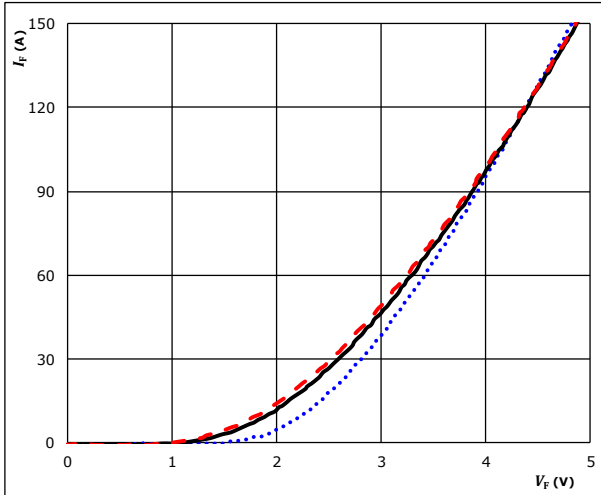

$t_p = 250 \mu s$
 T_j : 25 °C
125 °C ———
150 °C - - - -

figure 2. FWD

Transient thermal impedance as a function of pulse width

$$Z_{th(j-s)} = f(t_p)$$

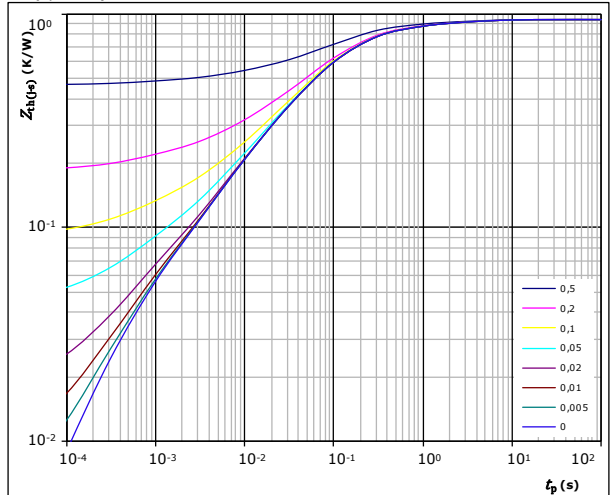

$D = t_p / T$
 $R_{th(j-s)} = 0,93 \text{ K/W}$
FWD thermal model values

R (K/W)	τ (s)
5,47E-02	3,65E+00
1,44E-01	5,33E-01
4,22E-01	1,06E-01
2,08E-01	2,50E-02
7,41E-02	4,04E-03
3,12E-02	4,73E-04

Thermistor Characteristics

figure 1. Thermistor

Typical NTC characteristic as a function of temperature

$$R = f(T)$$

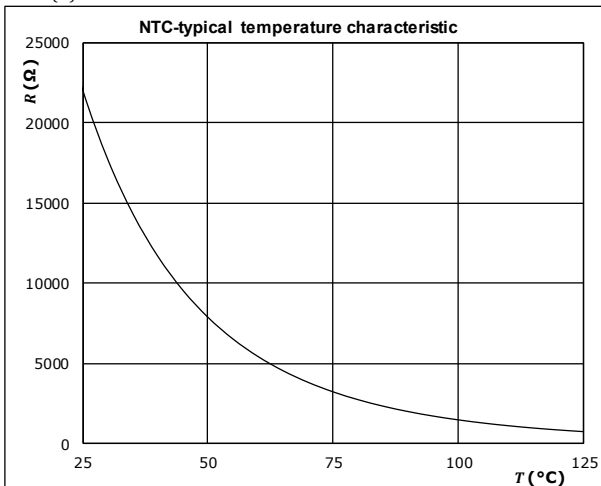



Inverter Switching Characteristics

figure 1. IGBT

Typical switching energy losses as a function of collector current

$$E = f(I_c)$$

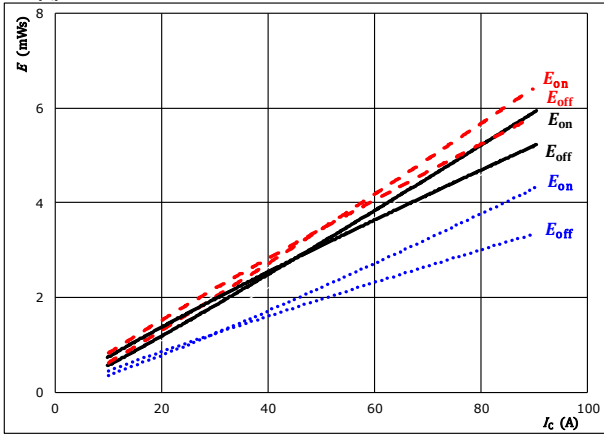

With an inductive load at

$V_{CE} = 600$ V	$T_j = 25$ °C
$V_{GE} = \pm 15$ V	$T_j = 125$ °C	————
$R_{g\text{on}} = 8$ Ω	$T_j = 150$ °C	-----
$R_{g\text{off}} = 8$ Ω		

figure 2. IGBT

Typical switching energy losses as a function of gate resistor

$$E = f(R_g)$$

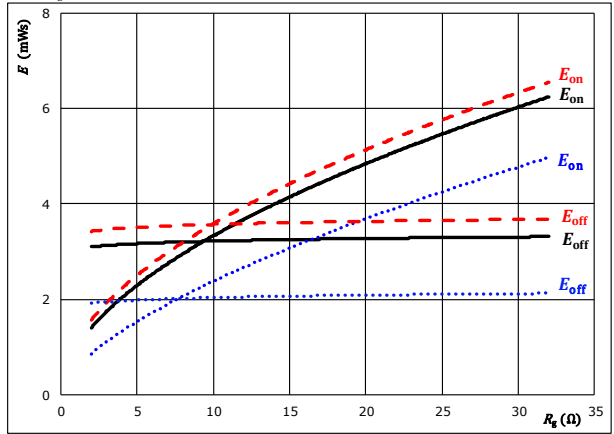

With an inductive load at

$V_{CE} = 600$ V	$T_j = 25$ °C
$V_{GE} = \pm 15$ V	$T_j = 125$ °C	————
$I_c = 50$ A	$T_j = 150$ °C	-----

figure 3. FWD

Typical reverse recovered energy loss as a function of collector current

$$E_{rec} = f(I_c)$$

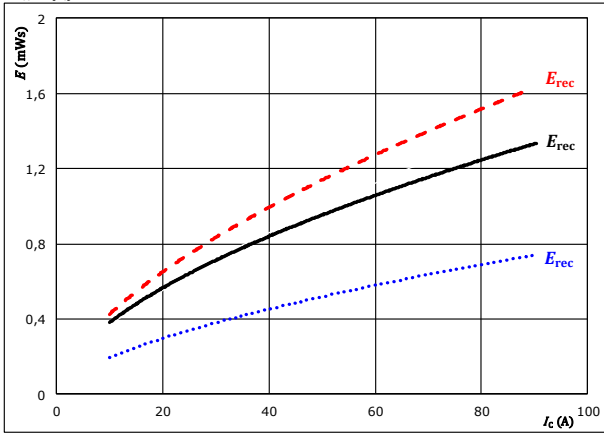

With an inductive load at

$V_{CE} = 600$ V	$T_j = 25$ °C
$V_{GE} = \pm 15$ V	$T_j = 125$ °C	————
$R_{g\text{on}} = 8$ Ω	$T_j = 150$ °C	-----

figure 4. FWD

Typical reverse recovered energy loss as a function of gate resistor

$$E_{rec} = f(R_g)$$

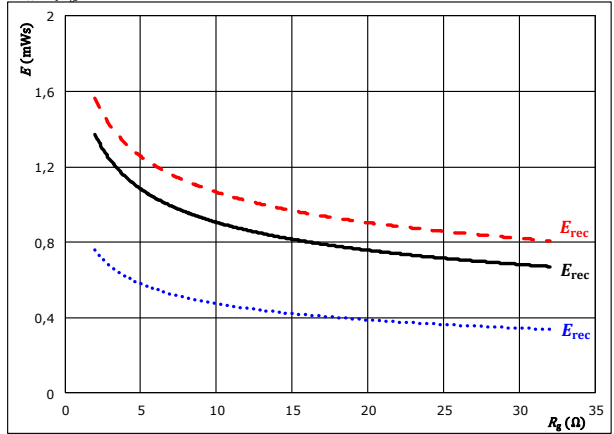

With an inductive load at

$V_{CE} = 600$ V	$T_j = 25$ °C
$V_{GE} = \pm 15$ V	$T_j = 125$ °C	————
$I_c = 50$ A	$T_j = 150$ °C	-----



Inverter Switching Characteristics

figure 5. IGBT

Typical switching times as a function of collector current

$$t = f(I_C)$$

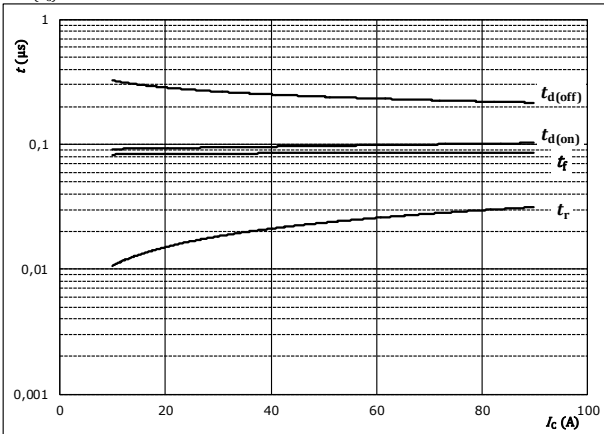

With an inductive load at

$T_j = 150$ °C
 $V_{CE} = 600$ V
 $V_{GE} = \pm 15$ V
 $R_{gon} = 8$ Ω
 $R_{goff} = 8$ Ω

figure 6. IGBT

Typical switching times as a function of gate resistor

$$t = f(R_g)$$

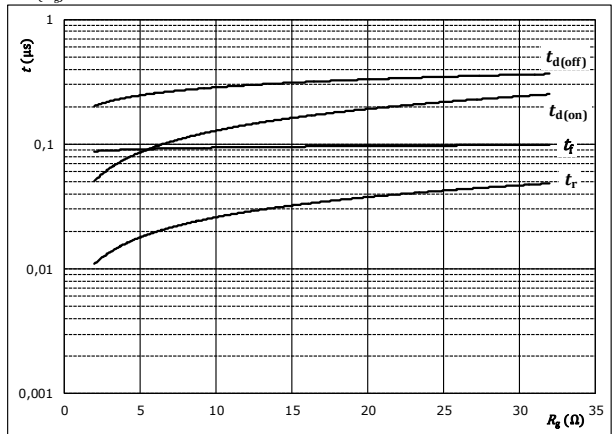

With an inductive load at

$T_j = 150$ °C
 $V_{CE} = 600$ V
 $V_{GE} = \pm 15$ V
 $I_C = 50$ A

figure 7. FWD

Typical reverse recovery time as a function of collector current

$$t_{rr} = f(I_C)$$

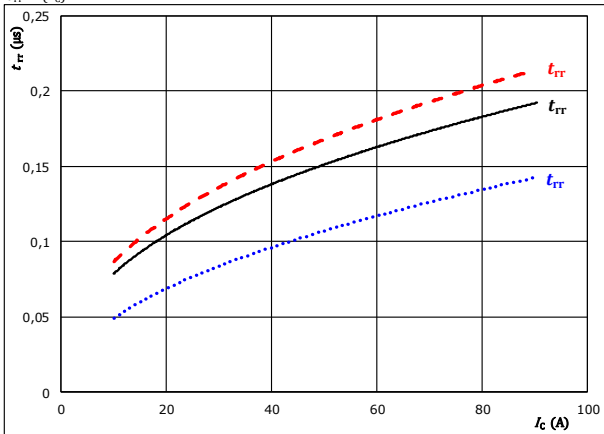

With an inductive load at

$V_{CE} = 600$ V
 $V_{GE} = \pm 15$ V
 $R_{gon} = 8$ Ω
 $T_j = 25$ °C (dotted)
 $T_j = 125$ °C (solid)
 $T_j = 150$ °C (dashed)

figure 8. FWD

Typical reverse recovery time as a function of IGBT turn on gate resistor

$$t_{rr} = f(R_{gon})$$

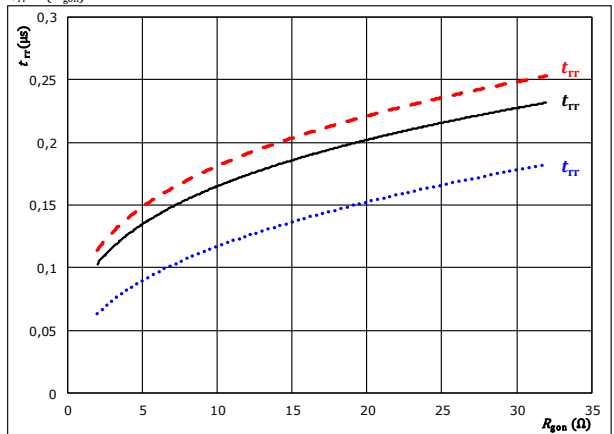

With an inductive load at

$V_{CE} = 600$ V
 $V_{GE} = \pm 15$ V
 $I_C = 50$ A
 $T_j = 25$ °C (dotted)
 $T_j = 125$ °C (solid)
 $T_j = 150$ °C (dashed)



Inverter Switching Characteristics

figure 9. FWD

Typical recovered charge as a function of collector current

$$Q_r = f(I_c)$$

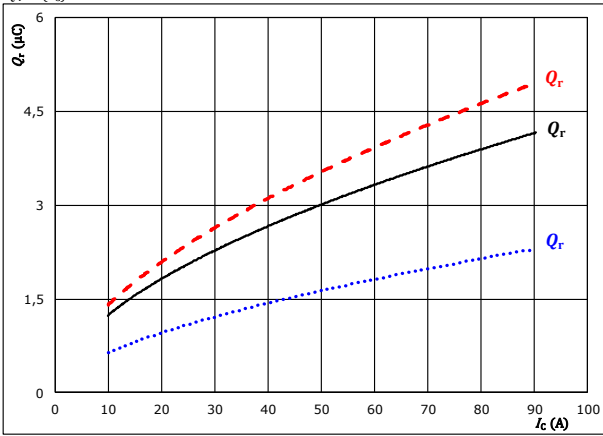

With an inductive load at
 $V_{CE} = 600$ V
 $V_{GE} = \pm 15$ V
 $R_{gon} = 8$ Ω
 T_j : 25 °C (blue dotted), 125 °C (black solid), 150 °C (red dashed)

figure 10. FWD

Typical recovered charge as a function of IGBT turn on gate resistor

$$Q_r = f(R_{gon})$$

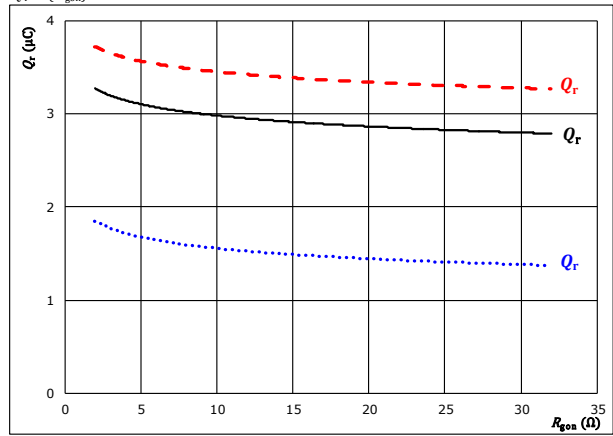

With an inductive load at
 $V_{CE} = 600$ V
 $V_{GE} = \pm 15$ V
 $I_c = 50$ A
 T_j : 25 °C (blue dotted), 125 °C (black solid), 150 °C (red dashed)

figure 11. FWD

Typical peak reverse recovery current as a function of collector current

$$I_{RM} = f(I_c)$$

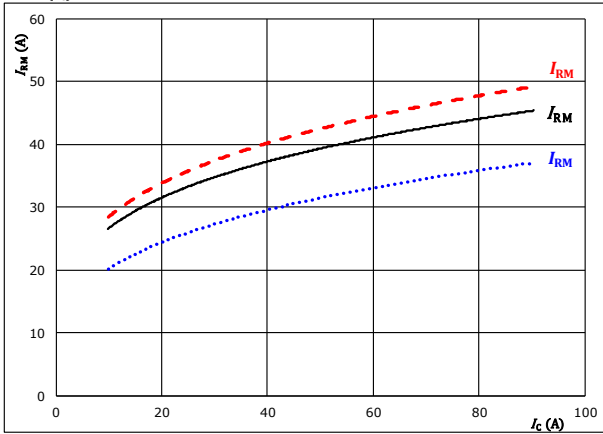

With an inductive load at
 $V_{CE} = 600$ V
 $V_{GE} = \pm 15$ V
 $R_{gon} = 8$ Ω
 T_j : 25 °C (blue dotted), 125 °C (black solid), 150 °C (red dashed)

figure 12. FWD

Typical peak reverse recovery current as a function of IGBT turn on gate resistor

$$I_{RM} = f(R_{gon})$$

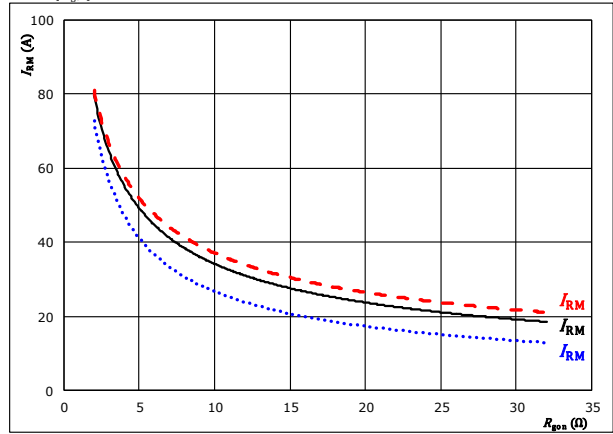

With an inductive load at
 $V_{CE} = 600$ V
 $V_{GE} = \pm 15$ V
 $I_c = 50$ A
 T_j : 25 °C (blue dotted), 125 °C (black solid), 150 °C (red dashed)



Inverter Switching Characteristics

figure 13. FWD

Typical rate of fall of forward and reverse recovery current as a function of collector current
 $di_f/dt, di_{rr}/dt = f(I_C)$

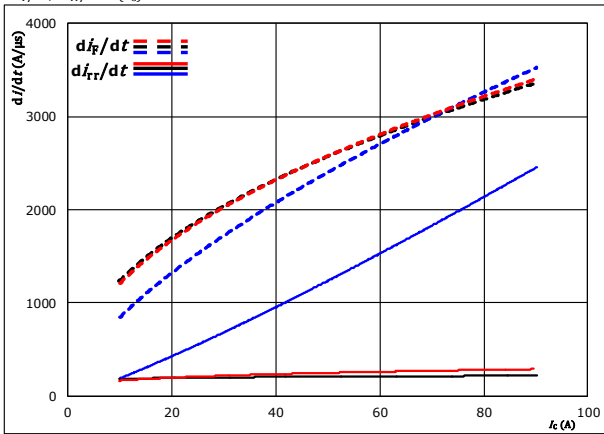

With an inductive load at
 $V_{CE} = 600$ V
 $V_{GE} = \pm 15$ V
 $R_{g0n} = 8$ Ω
 $T_j = 25$ °C
 125 °C
 150 °C

figure 14. FWD

Typical rate of fall of forward and reverse recovery current as a function of IGBT turn on gate resistor
 $di_f/dt, di_{rr}/dt = f(R_{g0n})$

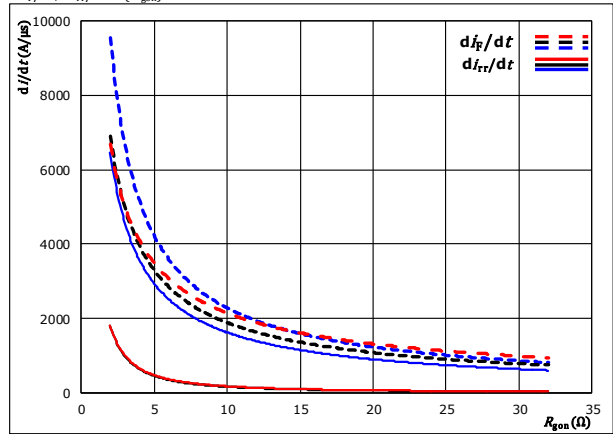

With an inductive load at
 $V_{CE} = 600$ V
 $V_{GE} = \pm 15$ V
 $I_C = 50$ A
 $T_j = 25$ °C
 125 °C
 150 °C

figure 15. IGBT

Reverse bias safe operating area
 $I_C = f(V_{CB})$

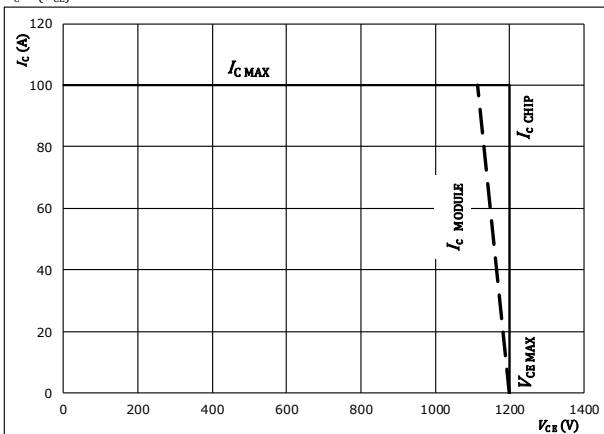

At
 $T_j = 125$ °C
 $R_{g0n} = 8$ Ω
 $R_{g0ff} = 8$ Ω



Inverter Switching Definitions

General conditions		
T_j	=	125 °C
R_{gon}	=	8 Ω
R_{goff}	=	8 Ω

figure 1. IGBT

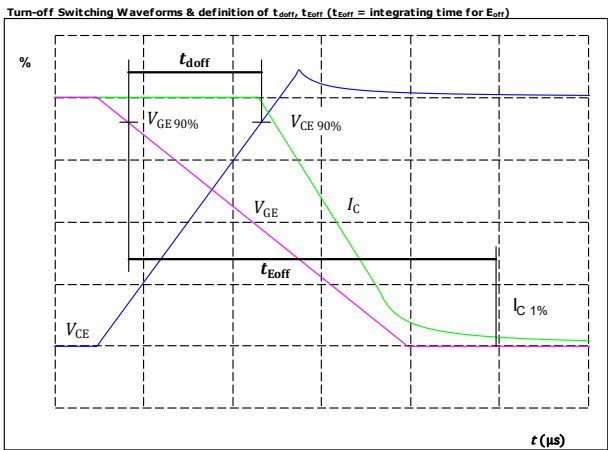

$V_{CE}(0\%) =$	-15	V
$V_{GE}(100\%) =$	15	V
$V_C(100\%) =$	600	V
$I_C(100\%) =$	50	A
$t_{doff} =$	236	ns

figure 2. IGBT

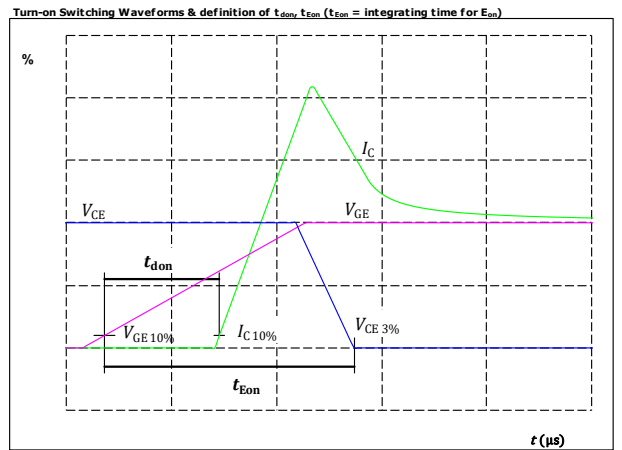

$V_{CE}(0\%) =$	-15	V
$V_{GE}(100\%) =$	15	V
$V_C(100\%) =$	600	V
$I_C(100\%) =$	50	A
$t_{don} =$	95	ns

figure 3. IGBT

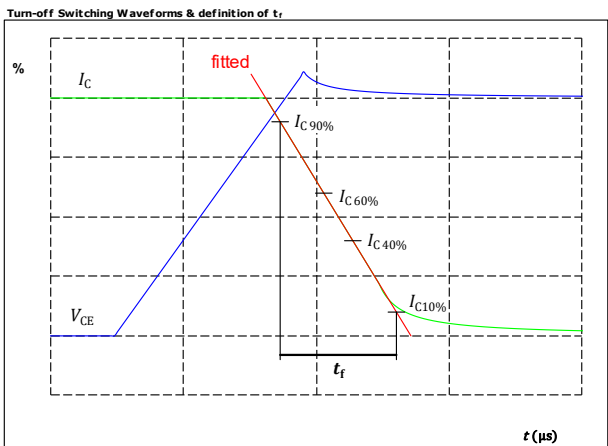

$V_C(100\%) =$	600	V
$I_C(100\%) =$	50	A
$t_f =$	87	ns

figure 4. IGBT

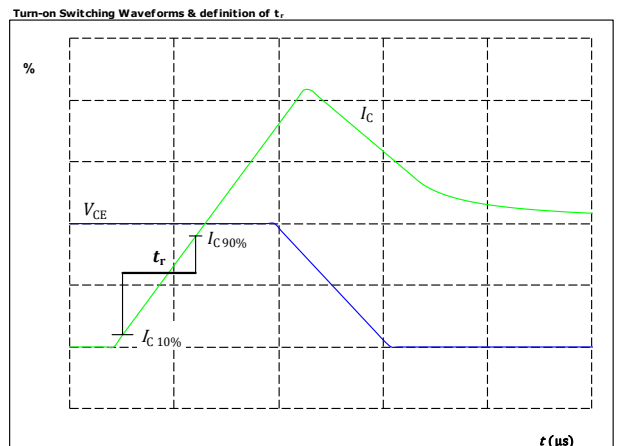

$V_C(100\%) =$	600	V
$I_C(100\%) =$	50	A
$t_r =$	24	ns



Vincotech

Inverter Switching Characteristics

figure 5. FWD

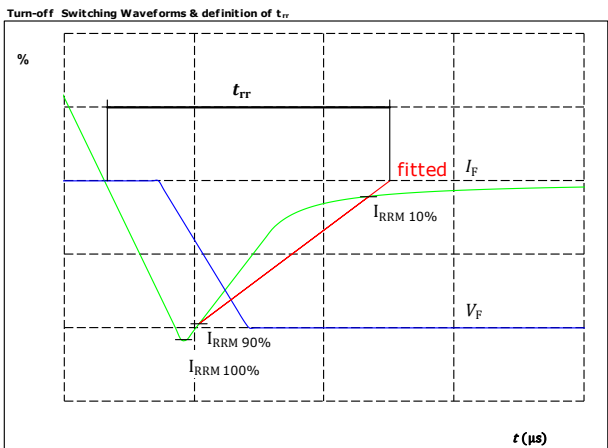

$V_F(100\%) =$	600	V
$I_F(100\%) =$	50	A
$I_{RRM}(100\%) =$	40	A
$t_{rr} =$	149	ns

figure 6. FWD

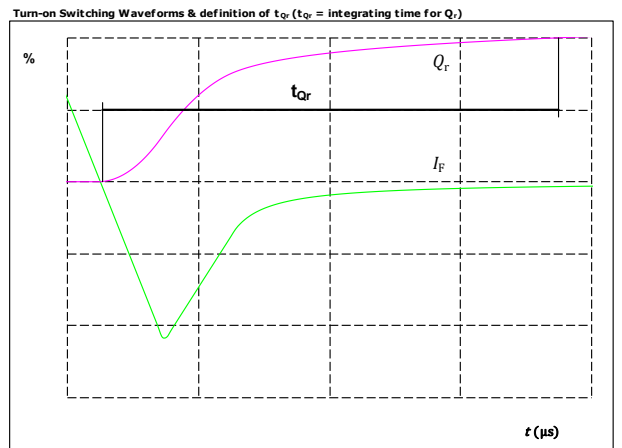

$I_F(100\%) =$	50	A
$Q_r(100\%) =$	3,04	μC



Vincotech

Ordering Code & Marking																																
Version			Ordering Code																													
without thermal paste 12mm housing with Press-fit pins			10-PY126TA050SH-L828F68Y																													
with thermal paste 12mm housing with Press-fit pins			10-PY126TA050SH-L828F68Y-/3/																													
<table border="1"> <thead> <tr> <th rowspan="2">Text</th> <th colspan="2">Name</th> <th>Date code</th> <th>UL & VIN</th> <th>Lot</th> <th>Serial</th> </tr> <tr> <th>Type&Ver</th> <th>Lot number</th> <th>Serial</th> <th>Date code</th> <th></th> <th></th> </tr> </thead> <tbody> <tr> <td rowspan="2"> NN-NNNNNNNNNNNN TTTTITV WWYY UL VIN LLLL SSSS </td> <td colspan="2">NN-NNNNNNNNNNNN-TTTTITV</td> <td>WWYY</td> <td>UL VIN</td> <td>LLLLL</td> <td>SSSS</td> </tr> <tr> <td>TTTTITV</td> <td>LLLLL</td> <td>SSSS</td> <td>WWYY</td> <td></td> <td></td> </tr> </tbody> </table>							Text	Name		Date code	UL & VIN	Lot	Serial	Type&Ver	Lot number	Serial	Date code			NN-NNNNNNNNNNNN TTTTITV WWYY UL VIN LLLL SSSS	NN-NNNNNNNNNNNN-TTTTITV		WWYY	UL VIN	LLLLL	SSSS	TTTTITV	LLLLL	SSSS	WWYY		
Text	Name		Date code	UL & VIN	Lot	Serial																										
	Type&Ver	Lot number	Serial	Date code																												
NN-NNNNNNNNNNNN TTTTITV WWYY UL VIN LLLL SSSS	NN-NNNNNNNNNNNN-TTTTITV		WWYY	UL VIN	LLLLL	SSSS																										
	TTTTITV	LLLLL	SSSS	WWYY																												

Pin table			
Pin	X	Y	Functions
1	52,6	0	DC-123
2	49,9	0	DC-123
3	42,65	0	G15
4	39,65	0	S15
5	35,15	0	Therm1
6	28,4	0	Therm2
7	24	0	G13
8	21	0	S13
9	12,2	0	G11
10	9,2	0	S11
11	2,7	0	DC-123
12	0	0	DC-123
13	0	14,65	DC+123
14	2,7	14,65	DC+123
15	0	28,6	Ph1
16	2,7	28,6	Ph1
17	5,4	28,6	Ph1
18	9,6	28,6	S12
19	12,6	28,6	G12
20	19,6	28,6	Ph2
21	22,3	28,6	Ph2
22	25	28,6	Ph2
23	29,7	28,6	S14
24	32,7	28,6	G14
25	39,7	28,6	S16
26	42,7	28,6	G16
27	47,2	28,6	Ph3
28	49,9	28,6	Ph3
29	52,6	28,6	Ph3
30	52,6	14,65	DC+123
31	49,9	14,65	DC+123

center of press-fit pinhead
for connection parameter see the handling instruction

12,93 ±0,1
16,2 ±0,5

14,3

26,3

Tolerance of pinpositions: ±0,5mm at the end of pins
Dimension of coordinate axis is only offset without tolerance



Vincotech

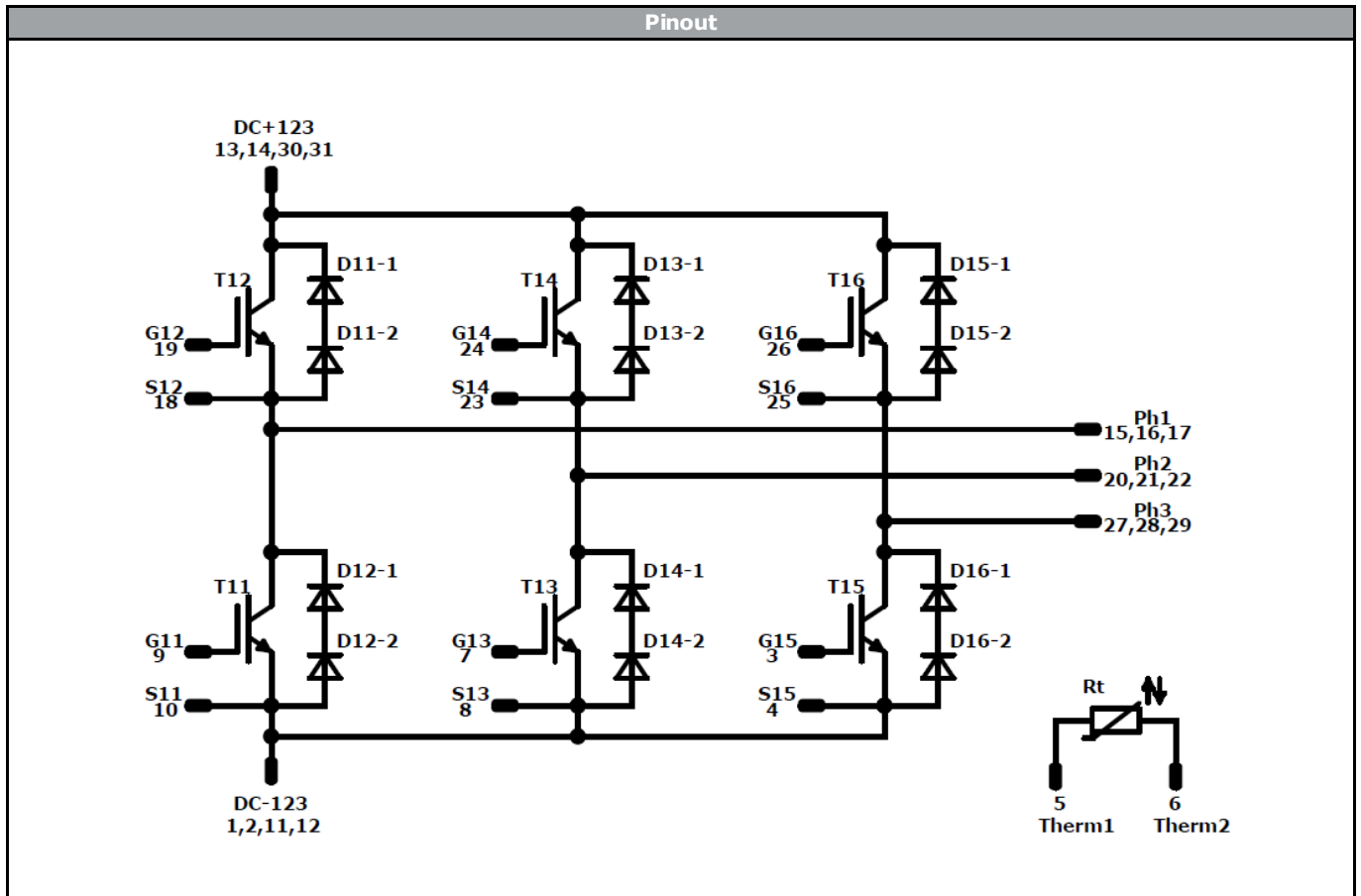

Identification					
ID	Component	Voltage	Current	Function	Comment
T11, T12, T13, T14, T15, T16	IGBT	1200 V	50 A	Inverter Switch	
D11, D12, D13, D14, D15, D16	FWD	1300 V	50 A	Inverter Diode	
Rt	NTC			Thermistor	



Vincotech

Packaging instruction			
Standard packaging quantity (SPQ) 100	>SPQ	Standard	<SPQ Sample

Handling instruction
Handling instructions for <i>flow 1</i> packages see vincotech.com website.

Package data
Package data for <i>flow 1</i> packages see vincotech.com website.

UL recognition and file number
This device is certified according to UL 1557 standard, UL file number E192116. For more information see vincotech.com website. 

Document No.:	Date:	Modification:	Pages
10-PY126TA050SH-L828F68Y-D2-14	13 Dec. 2018	Correct I_C , P_{tot} , $R_{th(j-s)}$ of Inverter Switch	1, 3, 5

DISCLAIMER

The information, specifications, procedures, methods and recommendations herein (together "information") are presented by Vincotech to reader in good faith, are believed to be accurate and reliable, but may well be incomplete and/or not applicable to all conditions or situations that may exist or occur. Vincotech reserves the right to make any changes without further notice to any products to improve reliability, function or design. No representation, guarantee or warranty is made to reader as to the accuracy, reliability or completeness of said information or that the application or use of any of the same will avoid hazards, accidents, losses, damages or injury of any kind to persons or property or that the same will not infringe third parties rights or give desired results. It is reader's sole responsibility to test and determine the suitability of the information and the product for reader's intended use.

LIFE SUPPORT POLICY

Vincotech products are not authorised for use as critical components in life support devices or systems without the express written approval of Vincotech.

As used herein:

1. Life support devices or systems are devices or systems which, (a) are intended for surgical implant into the body, or (b) support or sustain life, or (c) whose failure to perform when properly used in accordance with instructions for use provided in labelling can be reasonably expected to result in significant injury to the user.
2. A critical component is any component of a life support device or system whose failure to perform can be reasonably expected to cause the failure of the life support device or system, or to affect its safety or effectiveness.

单击下面可查看定价，库存，交付和生命周期等信息

[>>Vincotech\(威科\)](#)