

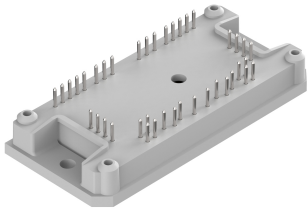

fastPACK 1		650 V / 100 A	
Features		flow 1 12 mm housing	
<ul style="list-style-type: none">• High-efficient H-Bridge• Open emitter topology• Integrated capacitors• Integrated thermistor• Low inductive 12mm housing			
Target applications		Schematic	
<ul style="list-style-type: none">• Power Supply• Solar Inverters• Welding & Cutting			
Types			
<ul style="list-style-type: none">• 10-FY074PA100SM-L583F08			

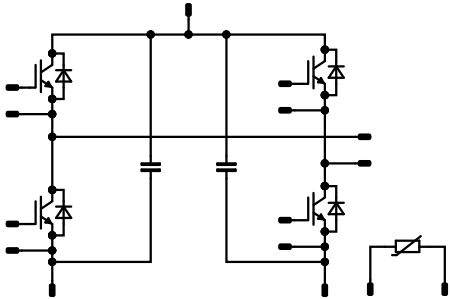

Vincotech

Maximum Ratings

$T_j = 25\text{ °C}$, unless otherwise specified

Parameter	Symbol	Conditions	Value	Unit
-----------	--------	------------	-------	------

H-Bridge Switch

Collector-emitter voltage	V_{CES}		650	V
Collector current (DC current)	I_C	$T_j = T_{jmax}$ $T_s = 80\text{ °C}$	80	A
Repetitive peak collector current	I_{CRM}	t_p limited by T_{jmax}	300	A
Total power dissipation	P_{tot}	$T_j = T_{jmax}$ $T_s = 80\text{ °C}$	138	W
Gate-emitter voltage	V_{GES}		±20	V
Maximum junction temperature	T_{jmax}		175	°C

H-Bridge Diode

Peak repetitive reverse voltage	V_{RRM}		650	V
Forward current (DC current)	I_F	$T_j = T_{jmax}$ $T_s = 80\text{ °C}$	67	A
Repetitive peak forward current	I_{FRM}	t_p limited by T_{jmax}	120	A
Total power dissipation	P_{tot}	$T_j = T_{jmax}$ $T_s = 80\text{ °C}$	94	W
Maximum junction temperature	T_{jmax}		175	°C

Capacitor (DC)

Maximum DC voltage	V_{MAX}		630	V
Operation Temperature	T_{op}		-55 ... 125	°C

Module Properties

Thermal Properties

Storage temperature	T_{stg}		-40...+125	°C
Operation temperature under switching condition	T_{jop}		-40...+($T_{jmax} - 25$)	°C

Isolation Properties

Isolation voltage	V_{isol}	DC Test Voltage* $t_p = 2\text{ s}$	6000	V
Isolation voltage	V_{isol}	AC Voltage $t_p = 1\text{ min}$	2500	V
Creepage distance			>12,7	mm
Clearance			7,66	mm
Comparative Tracking Index	CTI		≥ 200	

*100 % tested in production



Vincotech

Characteristic Values

Parameter	Symbol	Conditions					Values			Unit
		V_{GS} [V]	V_{GE} [V]	V_{DS} [V]	I_C [A]	T_j [°C]	Min	Typ	Max	

H-Bridge Switch

Static

Gate-emitter threshold voltage	$V_{GE(th)}$	$V_{CE} = V_{GE}$			0,001	25	3,3	4	4,7	V
Collector-emitter saturation voltage	$V_{CE(sat)}$		15		100	25 125		1,63 1,78	2,22 ⁽¹⁾	V
Collector-emitter cut-off current	I_{CES}		0	650		25			80	μA
Gate-emitter leakage current	I_{GES}		20	0		25			240	nA
Internal gate resistance	r_g							None		Ω
Input capacitance	C_{ies}							6000		pF
Output capacitance	C_{oes}	$f = 1 \text{ Mhz}$	0	25		25			100	pF
Reverse transfer capacitance	C_{res}								22	pF
Gate charge	Q_g		15	520	100	25		240		nC

Thermal

Thermal resistance junction to sink ⁽²⁾	$R_{th(j-s)}$	$\lambda_{\text{paste}} = 3,4 \text{ W/mK}$ (PSX)						0,69		K/W
--	---------------	--	--	--	--	--	--	------	--	-----

Dynamic

Turn-on delay time	$t_{d(on)}$	$R_{gon} = 4 \Omega$ $R_{goff} = 4 \Omega$	-5/15	350	100	25		45		ns
Rise time	t_r					125		48		
						150		46		
Turn-off delay time	$t_{d(off)}$					25		12		
						125		14		
						150		14		
Fall time	t_f	25		99						
		125		109						
		150		115						
Turn-on energy (per pulse)	E_{on}	$Q_{tFWD} = 2,63 \mu\text{C}$				25		1,08		mWs
		$Q_{tFWD} = 5,01 \mu\text{C}$				125		1,56		
		$Q_{tFWD} = 5,8 \mu\text{C}$				150		1,73		
Turn-off energy (per pulse)	E_{off}					25		0,79		mWs
						125		1,12		
						150		1,22		



Vincotech

Characteristic Values

Parameter	Symbol	Conditions					Values			Unit
		V_{GE} [V] V_{GS} [V]	V_{CE} [V] V_{DS} [V] V_F [V]	I_C [A] I_D [A] I_F [A]	T_j [°C]	Min	Typ	Max		

H-Bridge Diode

Static

Forward voltage	V_F				60	25 125 150		1,47 1,4 1,37	1,92 ⁽¹⁾	V
Reverse leakage current	I_R	$V_T = 650$ V				25			3,2	μA

Thermal

Thermal resistance junction to sink ⁽²⁾	$R_{th(j-s)}$	$\lambda_{paste} = 3,4$ W/mK (PSX)						1,01		K/W
--	---------------	---------------------------------------	--	--	--	--	--	------	--	-----

Dynamic

Peak recovery current	I_{RRM}					25 125 150		75,58 95,89 101,04		A
Reverse recovery time	t_{rr}					25 125 150		66,67 112,12 123,52		ns
Recovered charge	Q_r	$di/dt=5830$ A/μs $di/dt=5814$ A/μs $di/dt=5804$ A/μs	-5/15	350	100	25 125 150		2,63 5,01 5,8		μC
Reverse recovered energy	E_{rec}					25 125 150		0,693 1,33 1,56		mWs
Peak rate of fall of recovery current	$(di_r/dt)_{max}$					25 125 150		831,98 1072 1062		A/μs



Characteristic Values

Parameter	Symbol	Conditions					Values			Unit
		V_{GE} [V] V_{GS} [V]	V_{CE} [V] V_{DS} [V] V_F [V]	I_C [A] I_D [A] I_F [A]	T_j [°C]	Min	Typ	Max		

Capacitor (DC)

Static

Capacitance	C	DC bias voltage = 0 V				25		200		nF
Tolerance							-10		10	%
Dissipation factor		$f = 1$ kHz				25		2,5		%

Thermistor

Static

Rated resistance	R					25		22		k Ω
Deviation of R_{100}	$A_{R/R}$	$R_{100} = 1484 \Omega$				100	-5		5	%
Power dissipation	P							5		mW
Power dissipation constant	d					25		1,5		mW/K
B-value	$B_{(25/50)}$	Tol. ± 1 %						3962		K
B-value	$B_{(25/100)}$	Tol. ± 1 %						4000		K
Vincotech Thermistor Reference									I	

(1) Value at chip level

(2) Only valid with pre-applied Vincotech thermal interface material.



H-Bridge Switch Characteristics

figure 1. IGBT

Typical output characteristics
 $I_c = f(V_{CE})$

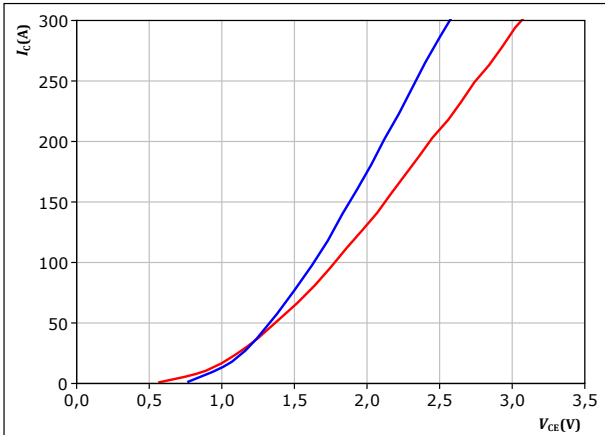

$t_p = 250 \mu s$
 $V_{GE} = 15 V$
 $T_j:$ — 25 °C
— 125 °C

figure 2. IGBT

Typical output characteristics
 $I_c = f(V_{CE})$

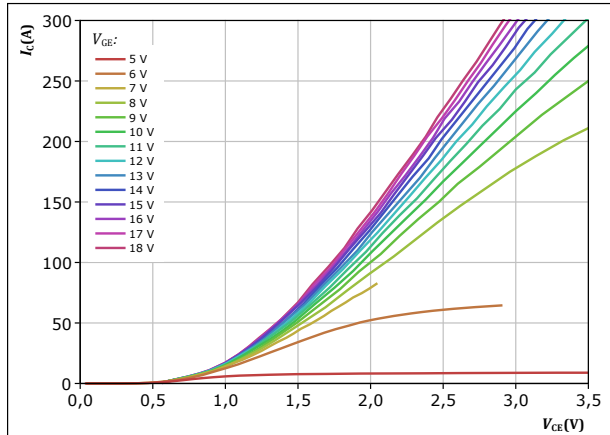

$t_p = 250 \mu s$
 $T_j = 125 \text{ °C}$
 V_{GE} from 5 V to 18 V in steps of 1 V

figure 3. IGBT

Typical transfer characteristics
 $I_c = f(V_{GE})$

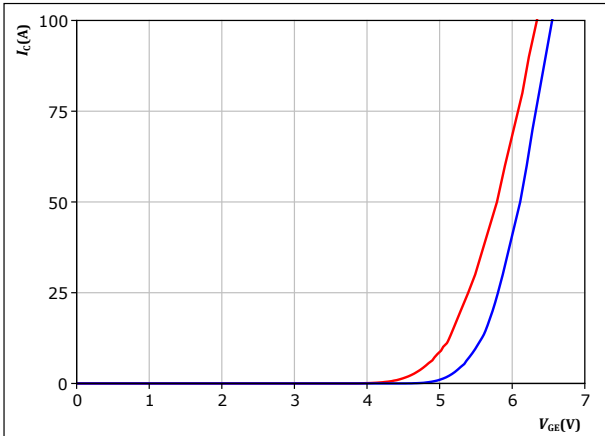

$t_p = 250 \mu s$
 $V_{CE} = 10 V$
 $T_j:$ — 25 °C
— 125 °C

figure 4. IGBT

Transient thermal impedance as a function of pulse width
 $Z_{th(j-s)} = f(t_p)$

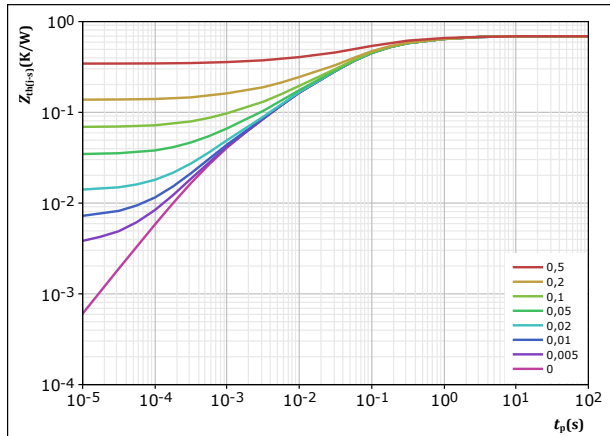

$D = t_p / T$
 $R_{th(j-s)} = 0,689 \text{ K/W}$
IGBT thermal model values

R (K/W)	τ (s)
7,95E-02	1,67E+00
1,86E-01	2,17E-01
2,94E-01	5,38E-02
1,03E-01	6,67E-03
2,63E-02	6,74E-04



H-Bridge Switch Characteristics

figure 5. IGBT

Safe operating area

$$I_C = f(V_{CE})$$

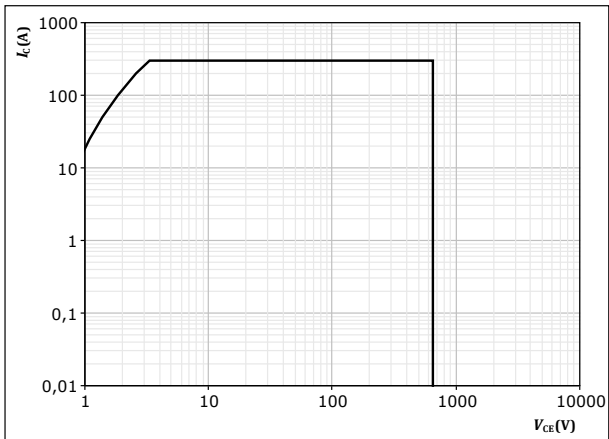

$D =$ single pulse
 $T_s = 80$ °C
 $V_{GE} = 15$ V
 $T_j = T_{jmax}$



H-Bridge Diode Characteristics

figure 6. FWD

Typical forward characteristics

$$I_F = f(V_F)$$

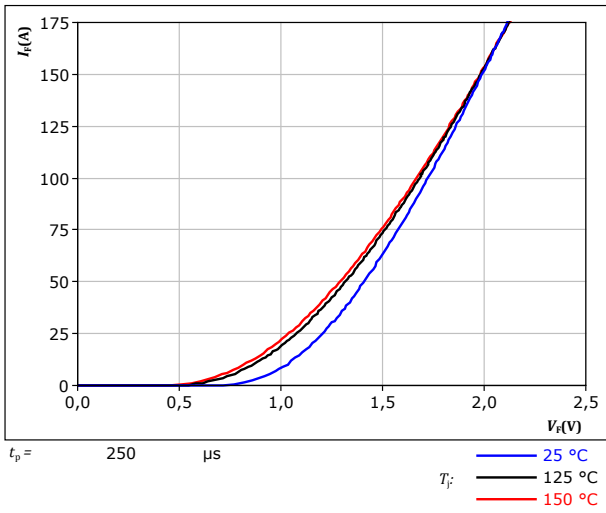
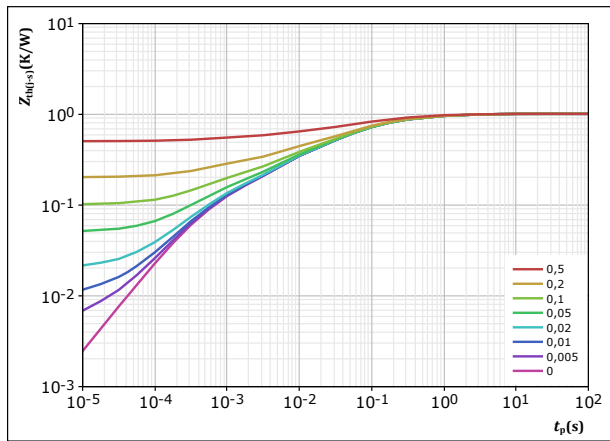

figure 7. FWD

Transient thermal impedance as a function of pulse width

$$Z_{th(j-s)} = f(t_p)$$



$D = t_p / T$
 $R_{th(j-s)} = 1,013 \text{ K/W}$
 FWD thermal model values

R (K/W)	τ (s)
8,97E-02	1,66E+00
2,71E-01	2,07E-01
3,50E-01	4,46E-02
2,06E-01	5,84E-03
9,57E-02	4,69E-04



Thermistor Characteristics

figure 8. Thermistor

Typical NTC characteristic as function of temperature

$$R_T = f(T)$$

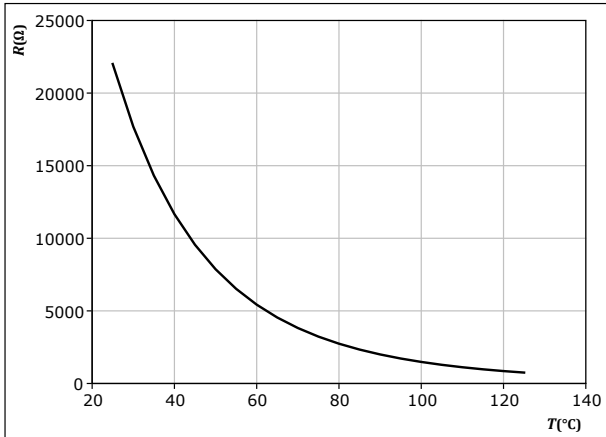



H-Bridge Switching Characteristics

figure 9. IGBT

Typical switching energy losses as a function of collector current
 $E = f(I_c)$

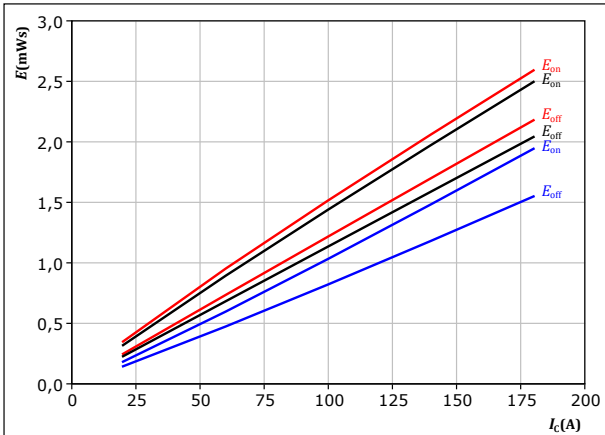

With an inductive load at
 $V_{CE} = 350 \text{ V}$
 $V_{GE} = -5/15 \text{ V}$
 $R_{gon} = 4 \ \Omega$
 $R_{goff} = 4 \ \Omega$

T_j : 25 °C (blue), 125 °C (black), 150 °C (red)

figure 10. IGBT

Typical switching energy losses as a function of gate resistor
 $E = f(R_g)$

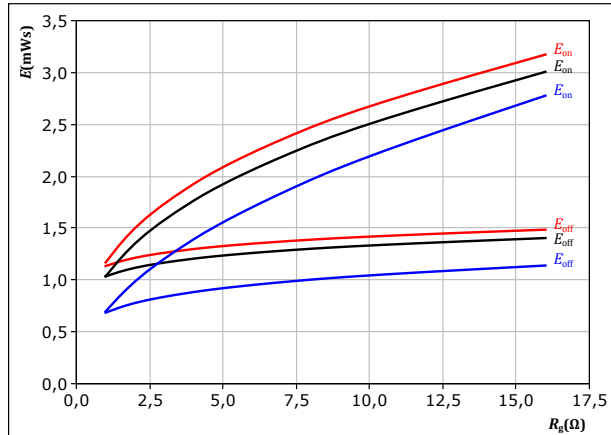

With an inductive load at
 $V_{CE} = 350 \text{ V}$
 $V_{GE} = -5/15 \text{ V}$
 $I_c = 100 \text{ A}$

T_j : 25 °C (blue), 125 °C (black), 150 °C (red)

figure 11. FWD

Typical reverse recovered energy loss as a function of collector current
 $E_{rec} = f(I_c)$

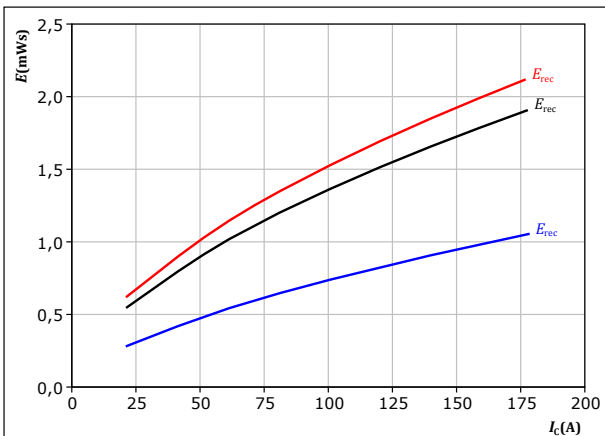

With an inductive load at
 $V_{CE} = 350 \text{ V}$
 $V_{GE} = -5/15 \text{ V}$
 $R_{gon} = 4 \ \Omega$

T_j : 25 °C (blue), 125 °C (black), 150 °C (red)

figure 12. FWD

Typical reverse recovered energy loss as a function of gate resistor
 $E_{rec} = f(R_g)$

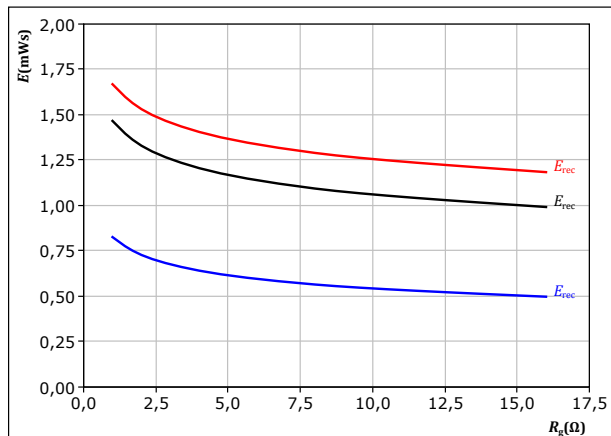

With an inductive load at
 $V_{CE} = 350 \text{ V}$
 $V_{GE} = -5/15 \text{ V}$
 $I_c = 100 \text{ A}$

T_j : 25 °C (blue), 125 °C (black), 150 °C (red)



H-Bridge Switching Characteristics

figure 13. IGBT

Typical switching times as a function of collector current
 $t = f(I_c)$

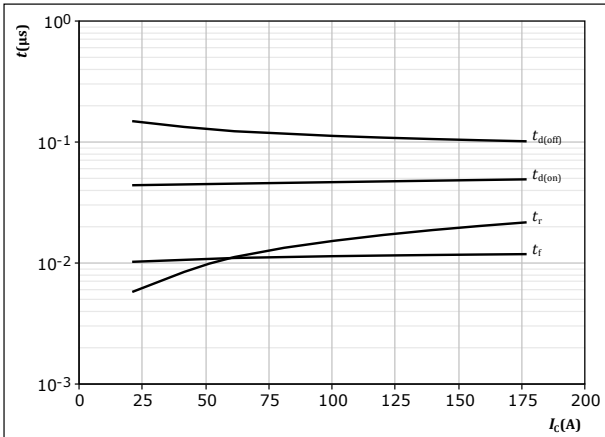

With an inductive load at
 $T_j = 150 \text{ }^\circ\text{C}$
 $V_{CE} = 350 \text{ V}$
 $V_{GE} = -5/15 \text{ V}$
 $R_{gon} = 4 \text{ } \Omega$
 $R_{goff} = 4 \text{ } \Omega$

figure 14. IGBT

Typical switching times as a function of gate resistor
 $t = f(R_g)$

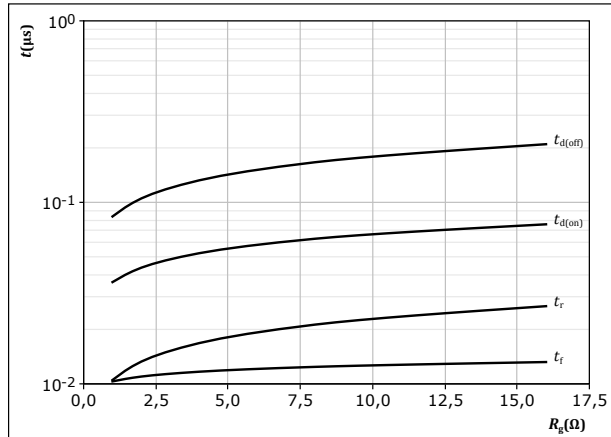

With an inductive load at
 $T_j = 150 \text{ }^\circ\text{C}$
 $V_{CE} = 350 \text{ V}$
 $V_{GE} = -5/15 \text{ V}$
 $I_c = 100 \text{ A}$

figure 15. FWD

Typical reverse recovery time as a function of collector current
 $t_{rr} = f(I_c)$

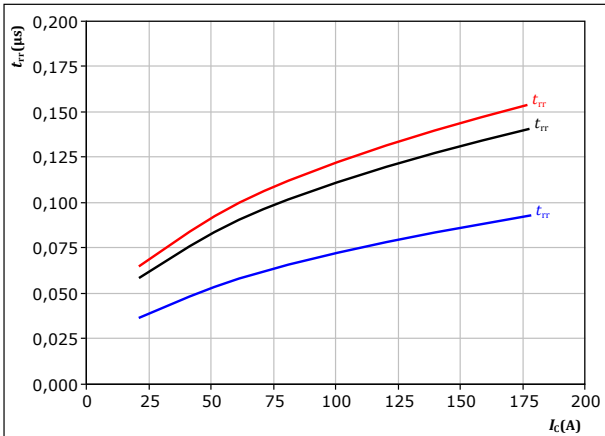

With an inductive load at
 $V_{CE} = 350 \text{ V}$
 $V_{GE} = -5/15 \text{ V}$
 $R_{gon} = 4 \text{ } \Omega$
 $T_j:$ — 25 °C
 — 125 °C
 — 150 °C

figure 16. FWD

Typical reverse recovery time as a function of IGBT turn off gate resistor
 $t_{rr} = f(R_{goff})$

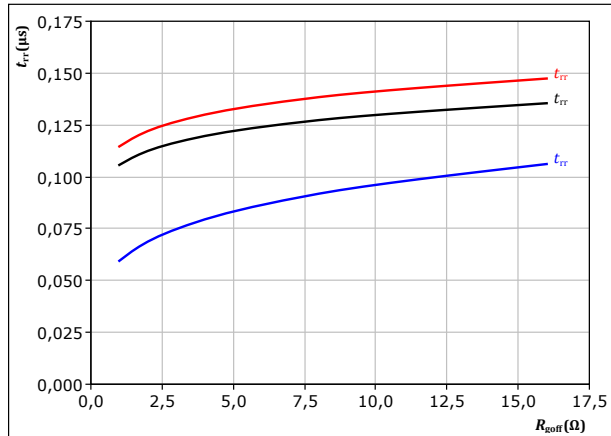

With an inductive load at
 $V_{CE} = 350 \text{ V}$
 $V_{GE} = -5/15 \text{ V}$
 $I_c = 100 \text{ A}$
 $T_j:$ — 25 °C
 — 125 °C
 — 150 °C



H-Bridge Switching Characteristics

figure 17. FWD

Typical recovered charge as a function of collector current

$$Q_r = f(I_c)$$

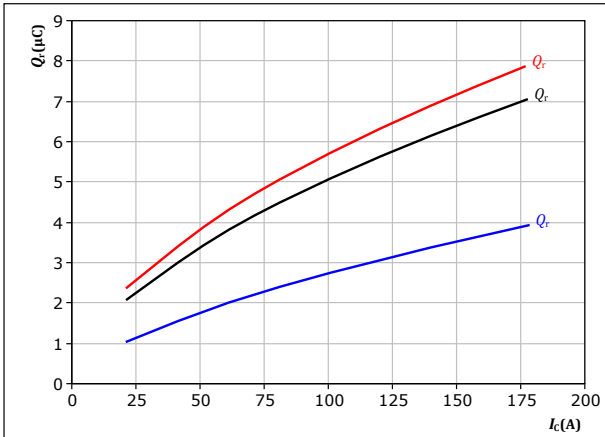

With an inductive load at

$V_{CE} = 350$ V
 $V_{GE} = -5/15$ V
 $R_{goff} = 4$ Ω

T_j : — 25 °C
— 125 °C
— 150 °C

figure 18. FWD

Typical recovered charge as a function of turn off gate resistor

$$Q_r = f(R_{goff})$$

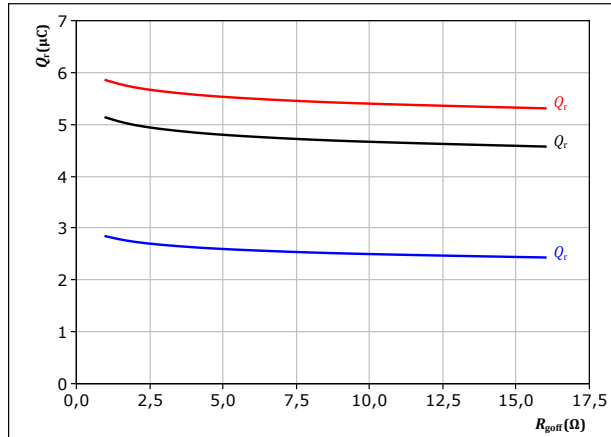

With an inductive load at

$V_{CE} = 350$ V
 $V_{GE} = -5/15$ V
 $I_c = 100$ A

T_j : — 25 °C
— 125 °C
— 150 °C

figure 19. FWD

Typical peak reverse recovery current as a function of collector current

$$I_{RM} = f(I_c)$$

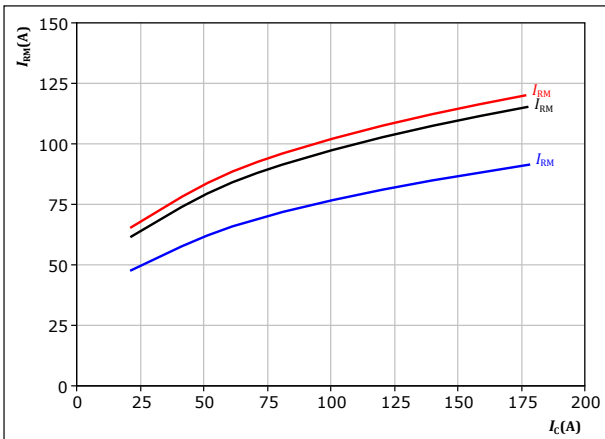

With an inductive load at

$V_{CE} = 350$ V
 $V_{GE} = -5/15$ V
 $R_{goff} = 4$ Ω

T_j : — 25 °C
— 125 °C
— 150 °C

figure 20. FWD

Typical peak reverse recovery current as a function of turn off gate resistor

$$I_{RM} = f(R_{goff})$$

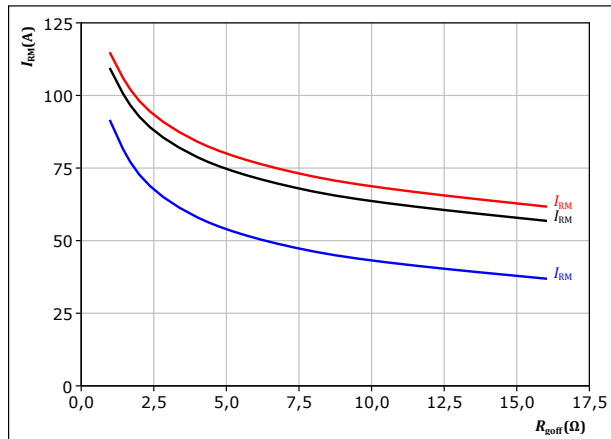

With an inductive load at

$V_{CE} = 350$ V
 $V_{GE} = -5/15$ V
 $I_c = 100$ A

T_j : — 25 °C
— 125 °C
— 150 °C



H-Bridge Switching Characteristics

figure 21. FWD

Typical rate of fall of forward and reverse recovery current as a function of collector current
 $di_f/dt, di_r/dt = f(I_c)$

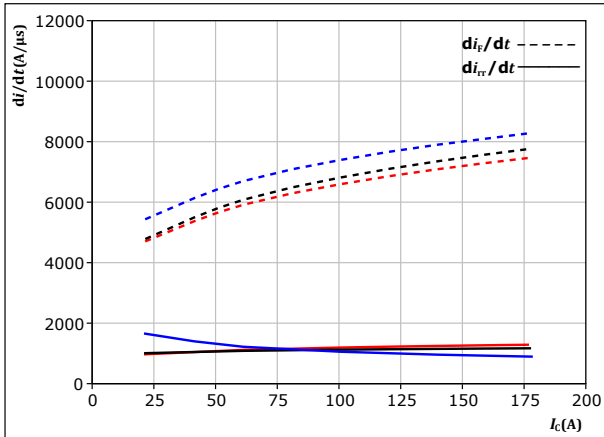

With an inductive load at

$V_{CE} = 350$ V
 $V_{GE} = -5/15$ V
 $R_{goff} = 4$ Ω

T_j : 25 °C
 125 °C
 150 °C

figure 22. FWD

Typical rate of fall of forward and reverse recovery current as a function of turn off gate resistor
 $di_f/dt, di_r/dt = f(R_{goff})$

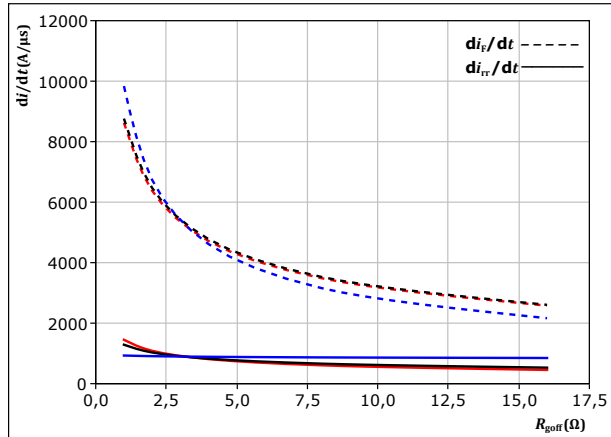

With an inductive load at

$V_{CE} = 350$ V
 $V_{GE} = -5/15$ V
 $I_c = 100$ A

T_j : 25 °C
 125 °C
 150 °C

figure 23. IGBT

Reverse bias safe operating area

$I_c = f(V_{CE})$

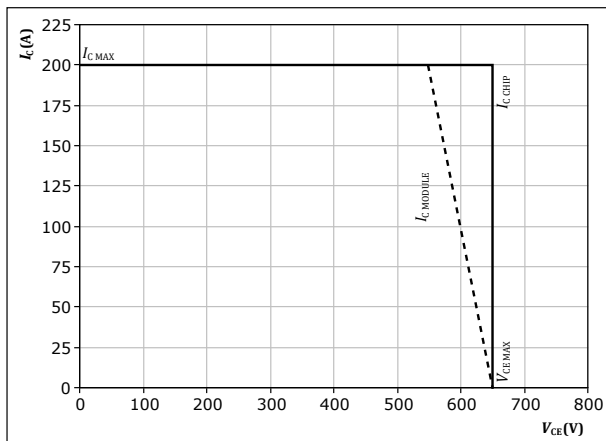

At $T_j = 150$ °C
 $R_{goff} = 4$ Ω
 $R_{goff} = 4$ Ω



H-Bridge Switching Definitions

figure 24. IGBT
Turn-off Switching Waveforms & definition of t_{doff} , t_{Eoff} (t_{Eoff} = integrating time for E_{off})

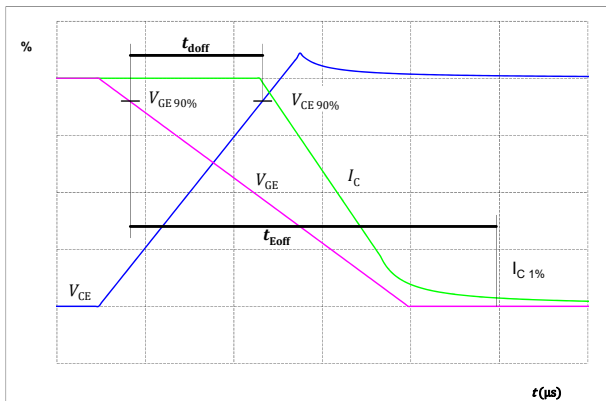

figure 25. IGBT
Turn-on Switching Waveforms & definition of t_{don} , t_{Eon} (t_{Eon} = integrating time for E_{on})



figure 26. IGBT
Turn-off Switching Waveforms & definition of t_f

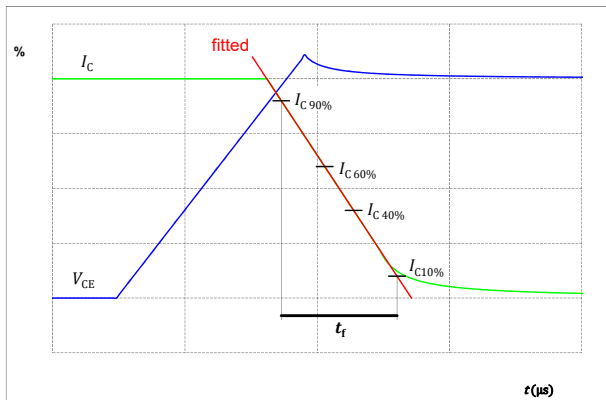
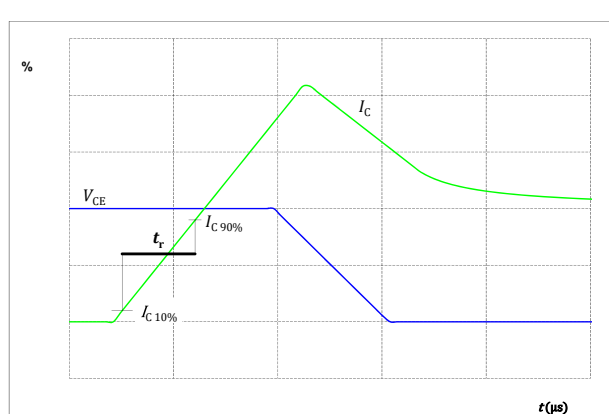

figure 27. IGBT
Turn-on Switching Waveforms & definition of t_r





H-Bridge Switching Definitions

figure 28. FWD

Turn-off Switching Waveforms & definition of t_{rr}



figure 29. FWD

Turn-on Switching Waveforms & definition of t_{Qr} (t_{Qr} = integrating time for Q_r)

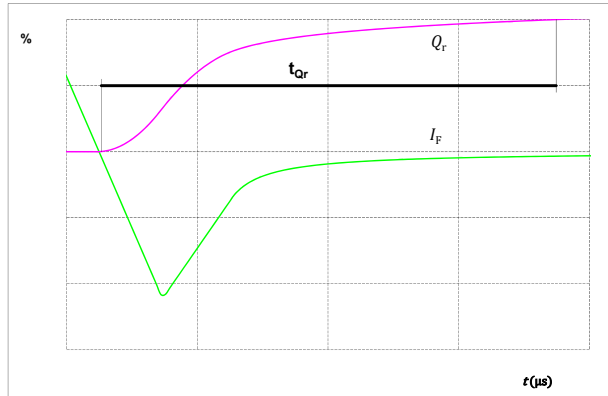



Vincotech

Ordering Code	
Version	Ordering Code
Without thermal paste	10-FY074PA100SM-L583F08
With thermal paste (5,2 W/mK, PTM6000HV)	10-FY074PA100SM-L583F08-/-7/
With thermal paste (3,4 W/mK, PSX-P7)	10-FY074PA100SM-L583F08-/-3/

Marking						
	Text	Name NN-NNNNNNNNNNNNNN- TTTTTIVV	Date code WWYY	UL & VIN UL VIN	Lot LLLLL	Serial SSSS
	Datamatrix	Type&Ver TTTTTIVV	Lot number LLLLL	Serial SSSS	Date code WWYY	

Outline			
Pin table [mm]			
Pin	X	Y	Function
1	46,3	2,7	DC-2
2	46,3	0	DC-2
3	43,6	2,7	DC-2
4	43,6	0	DC-2
5	39,2	1	G13-a
6	36,2	0	S13
7	33,2	1	G13-b
8	28,8	0	Therm2
9	23,8	0	Therm1
10	19,4	1	G11-b
11	16,4	0	S11
12	13,4	1	G11-a
13	9	2,7	DC-1
14	9	0	DC-1
15	6,3	2,7	DC-1
16	6,3	0	DC-1
17	0	6,8	DC+
18	0	9,5	DC+
19	0	12,2	DC+
20	0	14,9	DC+
21	0	28,6	Ph1
22	2,7	28,6	Ph1
23	5,4	28,6	Ph1
24	8,1	28,6	Ph1
25	10,8	28,6	Ph1
26	15,25	28,6	G12-a
27	18,25	28,6	S12
28	21,25	28,6	G12-b
29	31,35	28,6	G14-b
30	34,35	28,6	S14
31	37,35	28,6	G14-a
32	41,8	28,6	Ph2
33	44,5	28,6	Ph2
34	47,2	28,6	Ph2
35	49,9	28,6	Ph2
36	52,6	28,6	Ph2
37	52,6	14,9	DC+
38	52,6	12,2	DC+
39	52,6	9,5	DC+
40	52,6	6,8	DC+

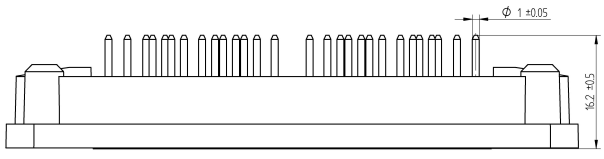
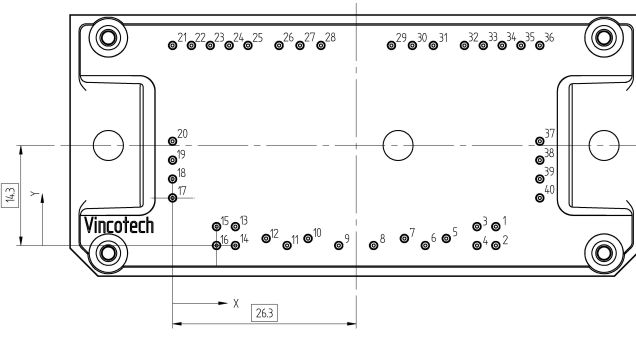
Tolerance of pinpositions: ±0.5mm at the end of pins
Dimension of coordinate axis is only offset without tolerance



Vincotech

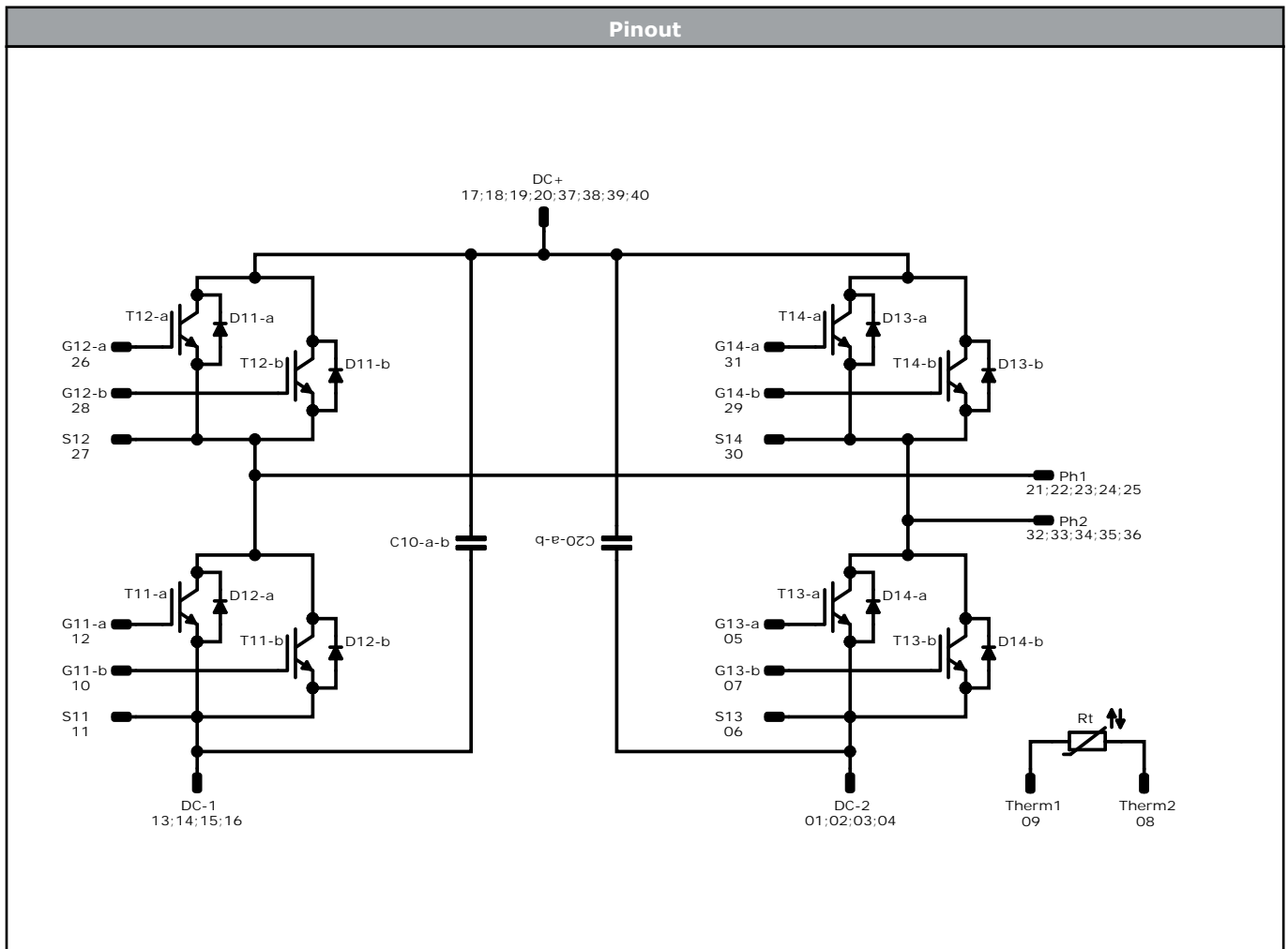

Identification					
ID	Component	Voltage	Current	Function	Comment
T11, T12, T13, T14	IGBT	650 V	100 A	H-Bridge Switch	
D11, D12, D13, D14	FWD	650 V	60 A	H-Bridge Diode	
C10, C20	Capacitor	630 V		Capacitor (DC)	
Rt	NTC			Thermistor	



Vincotech

Packaging instruction				
Standard packaging quantity (SPQ) 100	>SPQ	Standard	<SPQ	Sample

Handling instruction
Handling instructions for <i>flow 1</i> packages see vincotech.com website.

Package data
Package data for <i>flow 1</i> packages see vincotech.com website.

Vincotech thermistor reference
See Vincotech thermistor reference table at vincotech.com website.

UL recognition and file number
This device is certified according to UL 1557 standard, UL file number E192116. For more information see vincotech.com website. 

Document No.:	Date:	Modification:	Pages
10-FY074PA100SM-L583F08-D4-14	9 Sep. 2021	Thermal characteristics are updated New datasheet format, module is unchanged	

DISCLAIMER

The information, specifications, procedures, methods and recommendations herein (together "information") are presented by Vincotech to reader in good faith, are believed to be accurate and reliable, but may well be incomplete and/or not applicable to all conditions or situations that may exist or occur. Vincotech reserves the right to make any changes without further notice to any products to improve reliability, function or design. No representation, guarantee or warranty is made to reader as to the accuracy, reliability or completeness of said information or that the application or use of any of the same will avoid hazards, accidents, losses, damages or injury of any kind to persons or property or that the same will not infringe third parties rights or give desired results. It is reader's sole responsibility to test and determine the suitability of the information and the product for reader's intended use.

LIFE SUPPORT POLICY

Vincotech products are not authorised for use as critical components in life support devices or systems without the express written approval of Vincotech.

As used herein:

1. Life support devices or systems are devices or systems which, (a) are intended for surgical implant into the body, or (b) support or sustain life, or (c) whose failure to perform when properly used in accordance with instructions for use provided in labelling can be reasonably expected to result in significant injury to the user.
2. A critical component is any component of a life support device or system whose failure to perform can be reasonably expected to cause the failure of the life support device or system, or to affect its safety or effectiveness.

单击下面可查看定价，库存，交付和生命周期等信息

[>>Vincotech\(威科\)](#)