

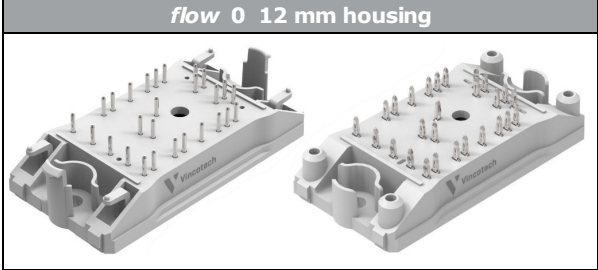
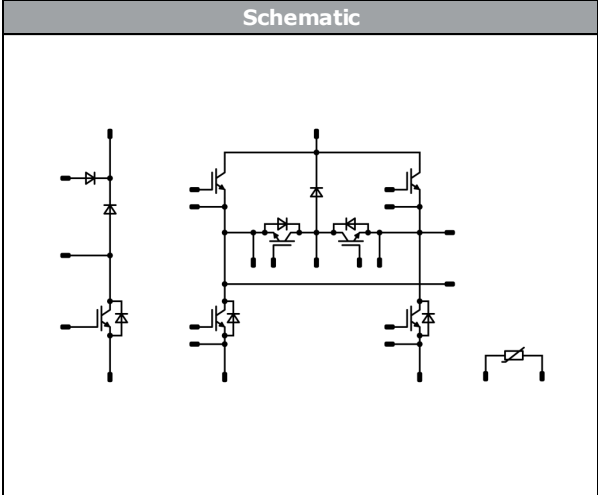

Vincotech

<i>flow SOL 0 BI (TL)</i>	650 V / 30 A
<div style="background-color: #eee; padding: 2px; margin-bottom: 5px;">Features</div> <ul style="list-style-type: none"> For one-phase solar applications Booster + Innovative H6.5 topology Fast IGBT S5 LVRT (Low voltage ride through) capability NTC 	<div style="background-color: #eee; padding: 2px; margin-bottom: 5px;"><i>flow 0 12 mm housing</i></div> 
<div style="background-color: #eee; padding: 2px; margin-bottom: 5px;">Target applications</div> <ul style="list-style-type: none"> Solar Inverters 	<div style="background-color: #eee; padding: 2px; margin-bottom: 5px;">Schematic</div> 
<div style="background-color: #eee; padding: 2px; margin-bottom: 5px;">Types</div> <ul style="list-style-type: none"> 10-FZ07BVA030S5-LD45E08 10-PC07BVA030S5-LD45E06Y 	

Maximum Ratings

$T_j = 25\text{ }^\circ\text{C}$, unless otherwise specified

Parameter	Symbol	Condition	Value	Unit
Low Buck Switch / High Buck Switch				
Collector-emitter voltage	V_{CES}		650	V
Collector current	I_C	$T_j = T_{jmax}$ $T_s = 80\text{ }^\circ\text{C}$	31	A
Repetitive peak collector current	I_{CRM}	t_p limited by T_{jmax}	90	A
Total power dissipation	P_{tot}	$T_j = T_{jmax}$ $T_s = 80\text{ }^\circ\text{C}$	51	W
Gate-emitter voltage	V_{GES}		± 20	V
Maximum junction temperature	T_{jmax}		175	$^\circ\text{C}$



Vincotech

Maximum Ratings

$T_j = 25\text{ °C}$, unless otherwise specified

Parameter	Symbol	Condition	Value	Unit
Buck Diode				
Peak repetitive reverse voltage	V_{RRM}		650	V
Continuous (direct) forward current	I_F	$T_j = T_{jmax}$ $T_s = 80\text{ °C}$	28	A
Repetitive peak forward current	I_{FRM}		40	A
Total power dissipation	P_{tot}	$T_j = T_{jmax}$ $T_s = 80\text{ °C}$	52	W
Maximum junction temperature	T_{jmax}		175	°C

Boost Switch

Collector-emitter voltage	V_{CES}		650	V
Collector current	I_C	$T_j = T_{jmax}$ $T_s = 80\text{ °C}$	24	A
Repetitive peak collector current	I_{CRM}	t_p limited by T_{jmax}	60	A
Total power dissipation	P_{tot}	$T_j = T_{jmax}$ $T_s = 80\text{ °C}$	46	W
Gate-emitter voltage	V_{GES}		± 20	V
Short circuit ratings	t_{SC} V_{CC}	$T_j \leq 150\text{ °C}$ $V_{GE} = 15\text{ V}$	6 360	μs V
Maximum Junction Temperature	T_{jmax}		175	°C

High Boost Diode / Low Boost Diode

Peak repetitive reverse voltage	V_{RRM}		650	V
Continuous (direct) forward current	I_F	$T_j = T_{jmax}$ $T_s = 80\text{ °C}$	28	A
Repetitive peak forward current	I_{FRM}		40	A
Total power dissipation	P_{tot}	$T_j = T_{jmax}$ $T_s = 80\text{ °C}$	52	W
Maximum junction temperature	T_{jmax}		175	°C

Input Boost Switch

Collector-emitter voltage	V_{CES}		650	V
Collector current	I_C	$T_j = T_{jmax}$ $T_s = 80\text{ °C}$	31	A
Repetitive peak collector current	I_{CRM}	t_p limited by T_{jmax}	90	A
Total power dissipation	P_{tot}	$T_j = T_{jmax}$ $T_s = 80\text{ °C}$	51	W
Gate-emitter voltage	V_{GES}		± 20	V
Maximum junction temperature	T_{jmax}		175	°C



Vincotech

Maximum Ratings

$T_j = 25\text{ °C}$, unless otherwise specified

Parameter	Symbol	Condition	Value	Unit
Input Boost Diode				
Peak Repetitive Reverse Voltage	V_{RRM}		650	V
Continuous (direct) forward current	I_F	$T_j = T_{jmax}$ $T_s = 80\text{ °C}$	42	A
Repetitive peak forward current	I_{FRM}		60	A
Total power dissipation	P_{tot}	$T_j = T_{jmax}$ $T_s = 80\text{ °C}$	50	W
Maximum Junction Temperature	T_{jmax}		175	°C
Input Boost Sw. Protection Diode				
Peak Repetitive Reverse Voltage	V_{RRM}		650	V
Continuous (direct) forward current	I_F	$T_j = T_{jmax}$ $T_s = 80\text{ °C}$	14	A
Repetitive peak forward current	I_{FRM}	$T_j < 150\text{ °C}$	20	A
Total power dissipation	P_{tot}	$T_j = T_{jmax}$ $T_s = 80\text{ °C}$	33	W
Maximum Junction Temperature	T_{jmax}		175	°C
ByPass Diode				
Peak Repetitive Reverse Voltage	V_{RRM}		1600	V
Continuous (direct) forward current	I_F	$T_j = T_{jmax}$ $T_s = 80\text{ °C}$	46	A
Surge (non-repetitive) forward current	I_{FSM}	50 Hz Single Half Sine Wave $t_p = 10\text{ ms}$ $T_j = 150\text{ °C}$	270	A
Surge current capability	I^2t		370	A ² s
Total power dissipation	P_{tot}	$T_j = T_{jmax}$ $T_s = 80\text{ °C}$	56	W
Maximum Junction Temperature	T_{jmax}		150	°C



Vincotech

Maximum Ratings

$T_j = 25\text{ °C}$, unless otherwise specified

Parameter	Symbol	Condition	Value	Unit
-----------	--------	-----------	-------	------

Module Properties

Thermal Properties

Storage temperature	T_{stg}		-40...+125	°C
Operation temperature under switching condition	T_{top}		-40...(T _{max} - 25)	°C

Isolation Properties

Isolation voltage	V_{isol}	DC Test Voltage* $t_p = 2\text{ s}$	6000	V
		AC Voltage $t_p = 1\text{ min}$	2500	V
Creepage distance			min. 12,7	mm
Clearance			8,66	mm
Comparative Tracking Index	CTI		> 200	

*100 % tested in production



Vincotech

Characteristic Values

Parameter	Symbol	Conditions					Value			Unit
		V_{GE} [V] V_{GS} [V]	V_{CE} [V] V_{DS} [V] V_F [V]	I_C [A] I_D [A] I_F [A]	T_j [°C]	Min	Typ	Max		

Low Buck Switch / High Buck Switch

Static

Gate-emitter threshold voltage	$V_{GE(th)}$	$V_{GE} = V_{CE}$			0,0003	25	3,2	4	4,8	V
Collector-emitter saturation voltage	V_{CEsat}		15		30	25 125 150		1,35 1,54 1,57	1,75	V
Collector-emitter cut-off current	I_{CES}		0	650		25			50	μA
Gate-emitter leakage current	I_{GES}		20	0		25			100	nA
Internal gate resistance	r_g							none		Ω
Input capacitance	C_{ies}							1800		pF
Output capacitance	C_{oes}	$f = 1$ MHz	0	25		25		55		
Reverse transfer capacitance	C_{res}							7		
Gate charge	Q_g		15	520	30	25		70		nC

Thermal

Thermal resistance junction to sink	$R_{th(j-s)}$	phase-change material $\lambda = 3,4$ W/mK						1,86		K/W
-------------------------------------	---------------	---	--	--	--	--	--	------	--	-----

Dynamic

Turn-on delay time	$t_{d(on)}$					25 125 150		56 56 56		ns	
Rise time	t_r	$R_{goff} = 16$ Ω $R_{gon} = 16$ Ω				25 125 150		9 10 11			
Turn-off delay time	$t_{d(off)}$		±15	350	30	25 125 150		84 101 107			
Fall time	t_f					25 125 150		16 31 46			
Turn-on energy (per pulse)	E_{on}	$Q_{tFWD} = 0,9$ μC $Q_{tFWD} = 1,7$ μC $Q_{tFWD} = 1,8$ μC				25 125 150		0,571 0,698 0,739			mWs
Turn-off energy (per pulse)	E_{off}					25 125 150		0,197 0,377 0,430			



Vincotech

Characteristic Values

Parameter	Symbol	Conditions					Value			Unit
		V_{GE} [V] V_{GS} [V]	V_{CE} [V] V_{DS} [V]	I_C [A] I_D [A] I_F [A]	T_j [°C]	Min	Typ	Max		

Buck Diode

Static

Forward voltage	V_F			20	25 125		1,56 1,51	1,92	V
Reverse leakage current	I_R		650		25			1,28	μA

Thermal

Thermal resistance junction to sink	$R_{th(j-s)}$	phase-change material $\lambda = 3,4$ W/mK					1,82		K/W
-------------------------------------	---------------	---	--	--	--	--	------	--	-----

Dynamic

Peak recovery current	I_{RRM}				25 125 150		25 33 35		A
Reverse recovery time	t_{rr}				25 125 150		68 110 117		ns
Recovered charge	Q_r	$di/dt = \text{NaN A}/\mu\text{s}$ $di/dt = 3243 \text{ A}/\mu\text{s}$ $di/dt = 3146 \text{ A}/\mu\text{s}$	±15	350	30	25 125 150	0,888 1,656 1,834		μC
Reverse recovered energy	E_{rec}				25 125 150		0,154 0,330 0,373		mWs
Peak rate of fall of recovery current	$(di_{rf}/dt)_{max}$				25 125 150		1330 341 407		A/μs



Vincotech

Characteristic Values

Parameter	Symbol	Conditions					Value			Unit
		V_{GE} [V] V_{GS} [V]	V_{CE} [V] V_{DS} [V] V_F [V]	I_C [A] I_D [A] I_F [A]	T_j [°C]	Min	Typ	Max		

Boost Switch

Static

Gate-emitter threshold voltage	$V_{GE(th)}$	$V_{GE} = V_{CE}$			0,00029	25	5,1	5,8	6,4	V
Collector-emitter saturation voltage	V_{CEsat}		15		20	25 125	1,03	1,49 1,67	1,87	V
Collector-emitter cut-off current	I_{CES}		0	650		25			1	μA
Gate-emitter leakage current	I_{GES}		20	0		25			150	nA
Internal gate resistance	r_g							none		Ω
Input capacitance	C_{ies}							1100		pF
Output capacitance	C_{oes}	$f = 1$ MHz	0	25		25		71		
Reverse transfer capacitance	C_{res}							32		
Gate charge	Q_g		15	480	20	25		120		nC

Thermal

Thermal resistance junction to sink	$R_{th(j-s)}$	phase-change material $\lambda = 3,4$ W/mK						2,06		K/W
-------------------------------------	---------------	---	--	--	--	--	--	------	--	-----

Dynamic

Turn-on delay time	$t_{d(on)}$					25 125 150		62 61 61		ns
Rise time	t_r	$R_{goff} = 16$ Ω $R_{gon} = 16$ Ω				25 125 150		22 21 20		
Turn-off delay time	$t_{d(off)}$		±15	350	20	25 125 150		131 150 154		
Fall time	t_f					25 125 150		72 105 115		
Turn-on energy (per pulse)	E_{on}	$Q_{iFWD} = 0,6$ μC $Q_{iFWD} = 1,2$ μC $Q_{iFWD} = 1,4$ μC				25 125 150		0,524 0,705 0,765		
Turn-off energy (per pulse)	E_{off}					25 125 150		0,431 0,607 0,643		



Vincotech

Characteristic Values

Parameter	Symbol	Conditions					Value			Unit
		V_{GE} [V] V_{GS} [V]	V_{CE} [V] V_{DS} [V] V_F [V]	I_C [A] I_D [A] I_F [A]	T_j [°C]	Min	Typ	Max		

High Boost Diode / Low Boost Diode

Static

Forward voltage	V_F				20	25 125		1,56 1,51	1,92	V
Reverse leakage current	I_R			650		25			1,28	μA

Thermal

Thermal resistance junction to sink	$R_{th(j-s)}$	phase-change material $\lambda = 3,4$ W/mK						1,82		K/W
-------------------------------------	---------------	---	--	--	--	--	--	------	--	-----

Dynamic

Peak recovery current	I_{RRM}					25 125 150		13 17 18		A
Reverse recovery time	t_{rr}					25 125 150		72 114 127		ns
Recovered charge	Q_r	$di/dt = 1272$ A/μs $di/dt = 868$ A/μs $di/dt = 1011$ A/μs	±15	350	20	25 125 150		0,614 1,203 1,382		μC
Reverse recovered energy	E_{rec}					25 125 150		0,093 0,197 0,234		mWs
Peak rate of fall of recovery current	$(di_{rf}/dt)_{max}$					25 125 150		221 184 147		A/μs



Vincotech

Characteristic Values

Parameter	Symbol	Conditions					Value			Unit
		V_{GS} [V]	V_{GE} [V]	V_{DS} [V]	I_D [A]	T_j [°C]	Min	Typ	Max	

Input Boost Switch

Static

Parameter	Symbol	Conditions	V_{GS} [V]	V_{GE} [V]	V_{DS} [V]	I_D [A]	T_j [°C]	Min	Typ	Max	Unit
Gate-emitter threshold voltage	$V_{GE(th)}$	$V_{GE} = V_{CE}$				0,0003	25	3,2	4	4,8	V
Collector-emitter saturation voltage	V_{CEsat}		15			30	25 125 150		1,35 1,54 1,57	1,75	V
Collector-emitter cut-off current	I_{CES}		0	650			25			50	μA
Gate-emitter leakage current	I_{GES}		20	0			25			100	nA
Internal gate resistance	r_g								none		Ω
Input capacitance	C_{ies}								1800		pF
Output capacitance	C_{oes}	$f = 1$ MHz	0	25		25			55		
Reverse transfer capacitance	C_{res}								7		
Gate charge	Q_g		15	520	30		25		70		nC

Thermal

Parameter	Symbol	Conditions	V_{GS} [V]	V_{GE} [V]	V_{DS} [V]	I_D [A]	T_j [°C]	Min	Typ	Max	Unit
Thermal resistance junction to sink	$R_{th(j-s)}$	phase-change material $\lambda = 3,4$ W/mK							1,86		K/W

Dynamic

Parameter	Symbol	Conditions	V_{GS} [V]	V_{GE} [V]	V_{DS} [V]	I_D [A]	T_j [°C]	Min	Typ	Max	Unit
Turn-on delay time	$t_{d(on)}$						25 125 150		65 66 66		ns
Rise time	t_r	$R_{goff} = 16$ Ω $R_{gon} = 16$ Ω					25 125 150		8 9 10		
Turn-off delay time	$t_{d(off)}$		±15	350	30		25 125 150		87 106 111		
Fall time	t_f						25 125 150		15 33 45		
Turn-on energy (per pulse)	E_{on}	$Q_{iFWD} = 0,9$ μC $Q_{iFWD} = 1,7$ μC $Q_{iFWD} = 2$ μC					25 125 150		0,421 0,541 0,579		mWs
Turn-off energy (per pulse)	E_{off}						25 125 150		0,300 0,478 0,529		



Vincotech

Characteristic Values

Parameter	Symbol	Conditions					Value			Unit
		V_{GE} [V]	V_{CE} [V]	I_C [A]	T_j [°C]	Min	Typ	Max		

Input Boost Diode

Static

Parameter	Symbol	V_{GE} [V]	V_{CE} [V]	I_C [A]	T_j [°C]	Min	Typ	Max	Unit
Forward voltage	V_F			30	25		1,25	1,7	V
Reverse leakage current	I_r		650		25			1,6	μA

Thermal

Parameter	Symbol	Conditions	Value	Unit
Thermal resistance junction to sink	$R_{th(j-s)}$	phase-change material $\lambda = 3,4$ W/mK	1,92	K/W

Dynamic

Parameter	Symbol	V_{GE} [V]	V_{CE} [V]	I_C [A]	T_j [°C]	Min	Typ	Max	Unit
Peak recovery current	I_{RRM}				25 125 150		31 44 49		A
Reverse recovery time	t_{rr}				25 125 150		54 79 95		ns
Recovered charge	Q_r	$di/dt = 4199$ A/μs $di/dt = 3916$ A/μs $di/dt = 3772$ A/μs	±15	350	30	25 125 150	0,867 1,706 1,998		μC
Reverse recovered energy	E_{rec}				25 125 150		0,206 0,431 0,516		mWs
Peak rate of fall of recovery current	$(di_{rr}/dt)_{max}$				25 125 150		1540 650 780		A/μs

Input Boost Sw. Protection Diode

Static

Parameter	Symbol	V_{GE} [V]	V_{CE} [V]	I_C [A]	T_j [°C]	Min	Typ	Max	Unit
Forward voltage	V_F			10	25 125		1,67 1,56	1,87	V
Reverse leakage current	I_r		650		25			0,14	μA

Thermal

Parameter	Symbol	Conditions	Value	Unit
Thermal resistance junction to sink	$R_{th(j-s)}$	phase-change material $\lambda = 3,4$ W/mK	2,87	K/W



Vincotech

Characteristic Values

Parameter	Symbol	Conditions					Value			Unit
		V_{GE} [V] V_{GS} [V]	V_{CE} [V] V_{DS} [V]	I_C [A] I_D [A]	I_F [A]	T_j [°C]	Min	Typ	Max	

ByPass Diode

Static

Forward voltage	V_F				35	25 125	0,8	1,17 1,13	1,8	V
Reverse leakage current	I_r			1600		25 145			50 1100	μA

Thermal

Thermal resistance junction to sink	$R_{th(j-s)}$	phase-change material $\lambda = 3,4$ W/mK						1,25		K/W
-------------------------------------	---------------	---	--	--	--	--	--	------	--	-----

Thermistor

Rated resistance	R					25		22		kΩ
Deviation of R_{100}	$\Delta_{R/R}$	$R_{100} = 1484$ Ω				100	-5		5	%
Power dissipation	P					25		5		mW
Power dissipation constant						25		1,5		mW/K
B-value	$B_{(25/50)}$	Tol. ±1 %				25		3962		K
B-value	$B_{(25/100)}$	Tol. ±1 %				25		4000		K
Vincotech NTC Reference									I	



Vincotech

Low Buck Switch / High Buck Switch Characteristics

figure 1. IGBT

Typical output characteristics

$$I_C = f(V_{CE})$$

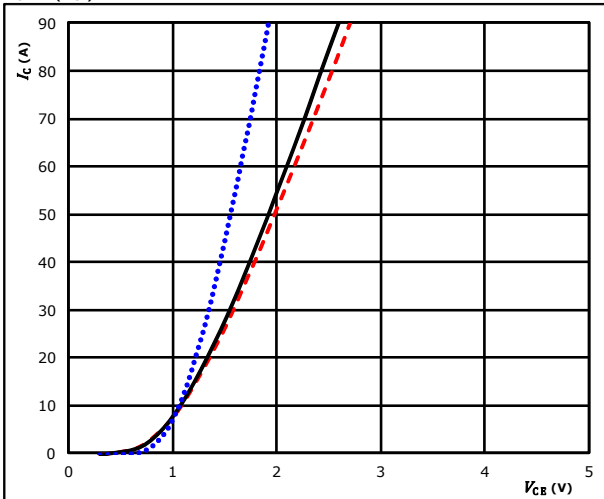

$t_p = 250 \mu\text{s}$
 $V_{GE} = 15 \text{ V}$
 $T_j: 25 \text{ }^\circ\text{C}$ (dotted blue)
 $125 \text{ }^\circ\text{C}$ (solid black)
 $150 \text{ }^\circ\text{C}$ (dashed red)

figure 2. IGBT

Typical output characteristics

$$I_C = f(V_{CE})$$

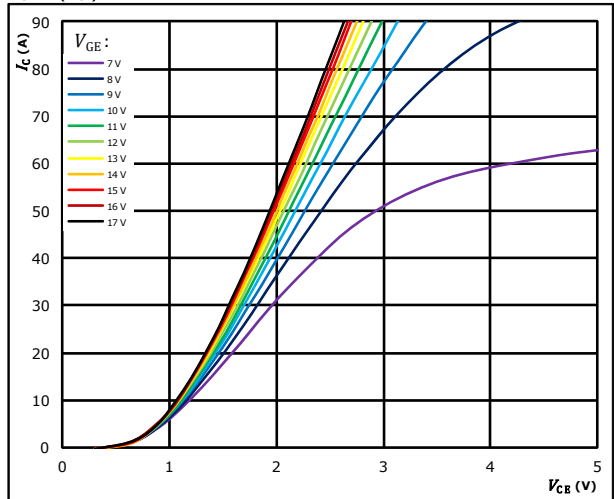

$t_p = 250 \mu\text{s}$
 $T_j = 150 \text{ }^\circ\text{C}$
 V_{GE} from 7 V to 17 V in steps of 1 V

figure 3. IGBT

Typical transfer characteristics

$$I_C = f(V_{GE})$$

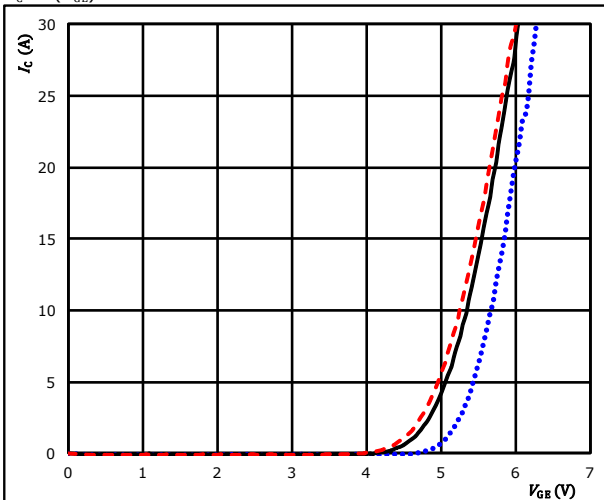

$t_p = 100 \mu\text{s}$
 $V_{CE} = 10 \text{ V}$
 $T_j: 25 \text{ }^\circ\text{C}$ (dotted blue)
 $125 \text{ }^\circ\text{C}$ (solid black)
 $150 \text{ }^\circ\text{C}$ (dashed red)

figure 4. IGBT

Transient thermal impedance as function of pulse duration

$$Z_{th(j-s)} = f(t_p)$$

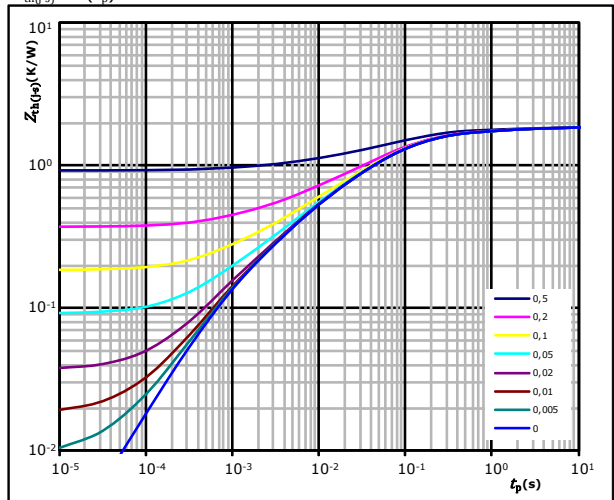

$D = t_p / T$
 $R_{th(j-s)} = 1,86 \text{ K/W}$
 IGBT thermal model values

R (K/W)	τ (s)
1,24E-01	2,76E+00
1,92E-01	4,60E-01
7,76E-01	9,02E-02
4,21E-01	2,36E-02
2,47E-01	5,25E-03
9,60E-02	8,07E-04



Vincotech

Low Buck Switch / High Buck Switch Characteristics

figure 5. IGBT

Gate voltage vs gate charge

$$V_{GE} = f(Q_G)$$

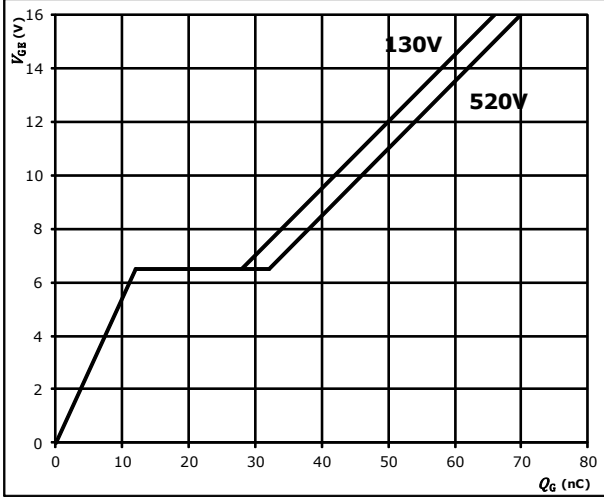

$I_C = 30$ A

figure 6. IGBT

Safe operating area

$$I_C = f(V_{CE})$$

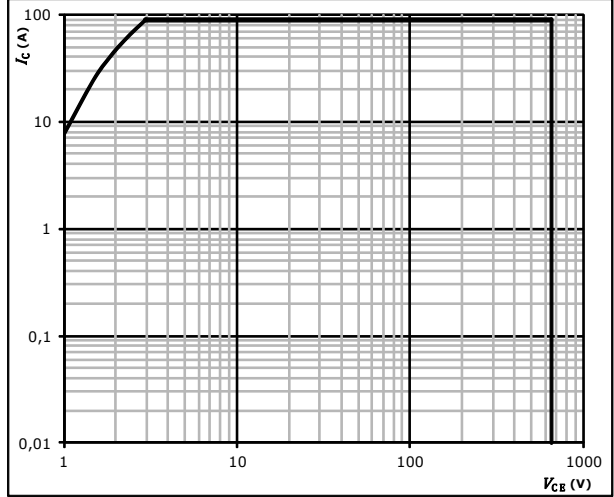

$D =$ single pulse
 $T_s = 80$ °C
 $V_{GE} = \pm 15$ V
 $T_j = T_{jmax}$



Buck Diode Characteristics

figure 1. FWD

Typical forward characteristics

$$I_F = f(V_F)$$

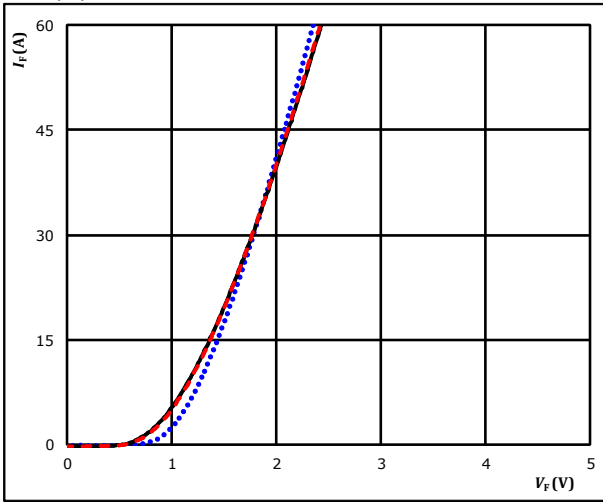

$t_p = 250 \mu s$
 T_j : 25 °C
 125 °C ———
 150 °C - - - -

figure 2. FWD

Transient thermal impedance as a function of pulse width

$$Z_{th(j-s)} = f(t_p)$$

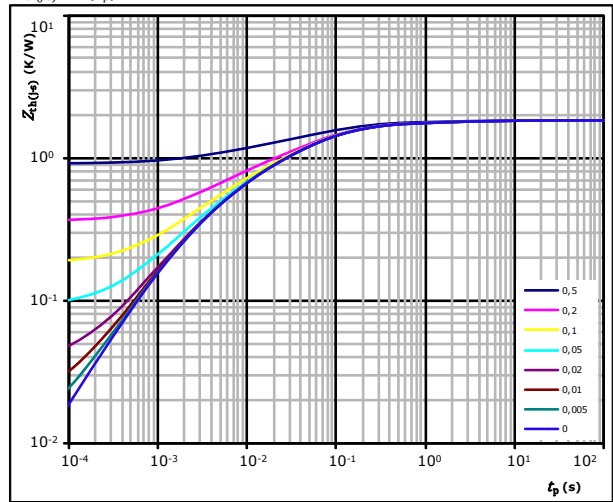

$D = t_p / T$
 $R_{th(j-s)} = 1,82 \text{ K/W}$
 FWD thermal model values

R (K/W)	τ (s)
5,26E-02	5,31E+00
1,17E-01	7,49E-01
5,61E-01	1,08E-01
5,47E-01	3,08E-02
3,91E-01	6,39E-03
1,49E-01	1,43E-03



Boost Switch Characteristics

figure 1. IGBT

Typical output characteristics

$I_C = f(V_{CE})$

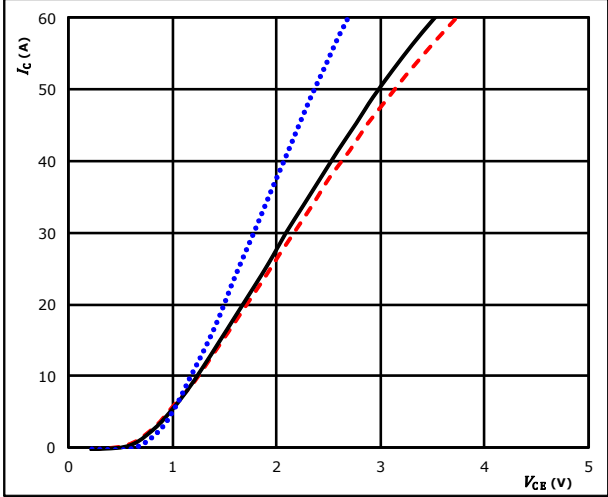

$t_p = 250 \mu s$
 $V_{GE} = 15 V$
 $T_j: 25 \text{ }^\circ C$ (dotted blue)
 $125 \text{ }^\circ C$ (solid black)
 $150 \text{ }^\circ C$ (dashed red)

figure 2. IGBT

Typical output characteristics

$I_C = f(V_{CE})$

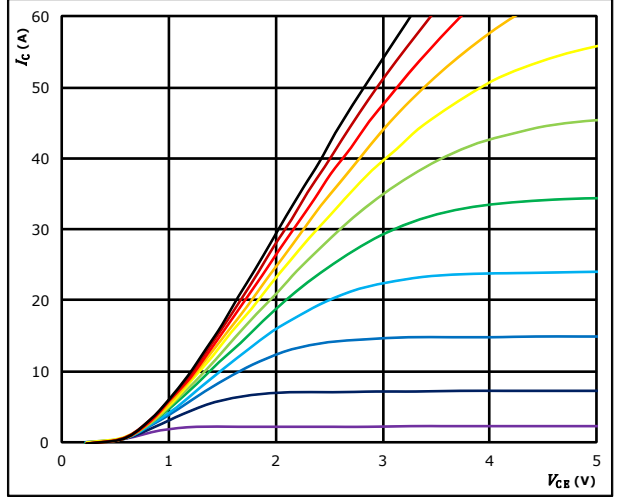

$t_p = 250 \mu s$
 $T_j = 150 \text{ }^\circ C$
 V_{GE} from 7 V to 17 V in steps of 1 V

figure 3. IGBT

Typical transfer characteristics

$I_C = f(V_{GE})$

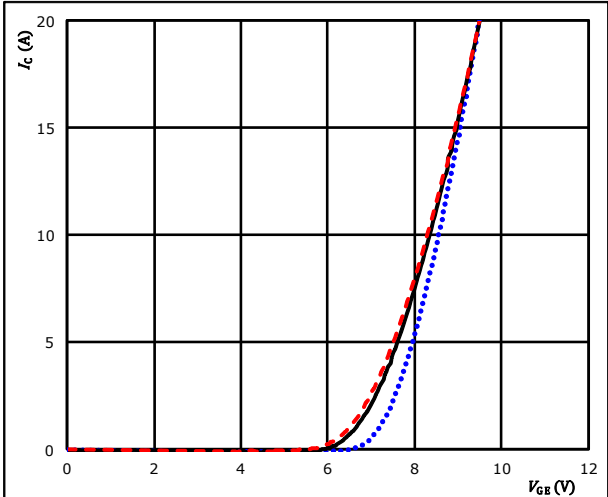

$t_p = 100 \mu s$
 $V_{CE} = 10 V$
 $T_j: 25 \text{ }^\circ C$ (dotted blue)
 $125 \text{ }^\circ C$ (solid black)
 $150 \text{ }^\circ C$ (dashed red)

figure 4. IGBT

Transient Thermal Impedance as function of Pulse duration

$Z_{th(j-s)} = f(t_p)$

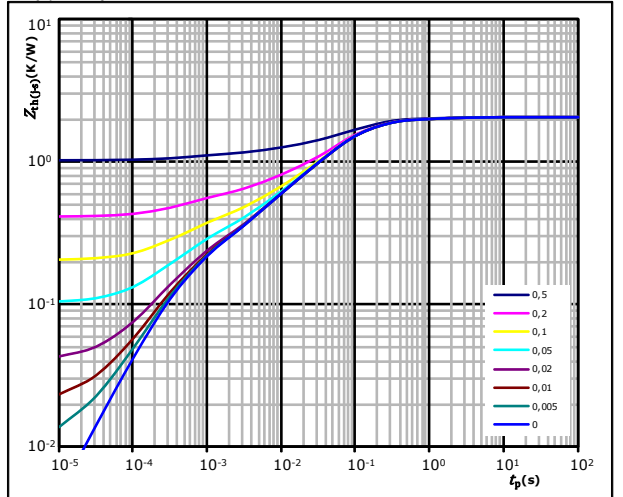

$D = t_p / T$
 $R_{th(j-s)} = 2,06 \text{ K/W}$
 IGBT thermal model values

R (K/W)	τ (s)
9,31E-02	1,78E+00
2,45E-01	2,71E-01
1,16E+00	6,94E-02
2,43E-01	1,36E-02
1,64E-01	3,45E-03
1,58E-01	4,12E-04



Boost Switch Characteristics

figure 5. IGBT

Gate voltage vs Gate charge

$V_{GE} = f(Q_G)$

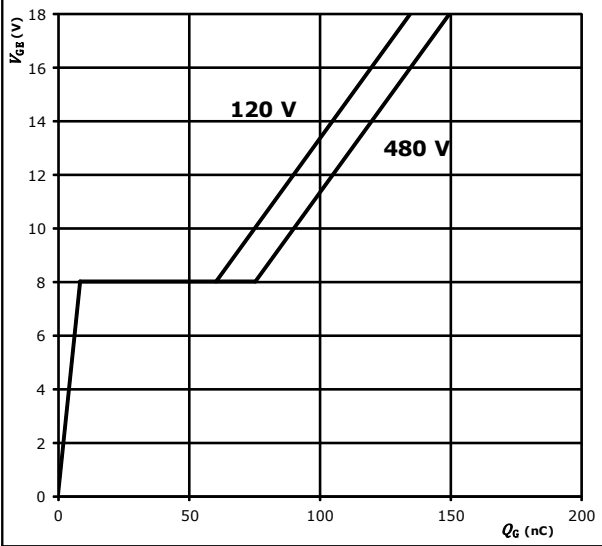

At
 $I_C = 20 \text{ A}$

figure 6. IGBT

Safe operating area

$I_C = f(V_{CE})$

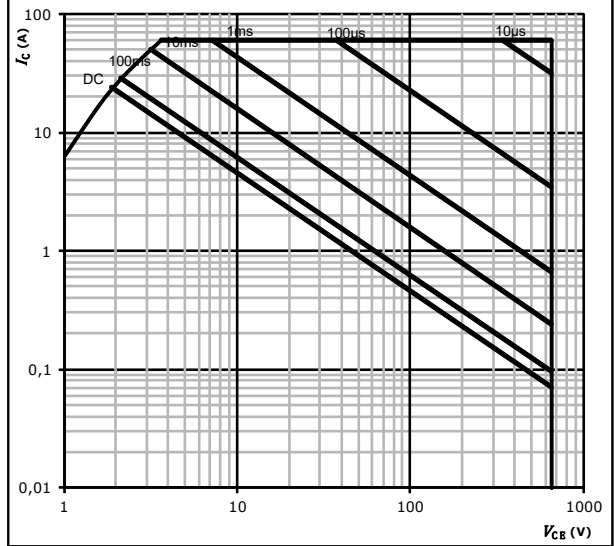

At
 $D = \text{single pulse}$
 $T_s = 80 \text{ }^\circ\text{C}$
 $V_{GE} = \pm 15 \text{ V}$
 $T_j = T_{jmax}$

figure 7. IGBT

Short circuit duration as a function of VGE

$t_{pSC} = f(V_{GE})$

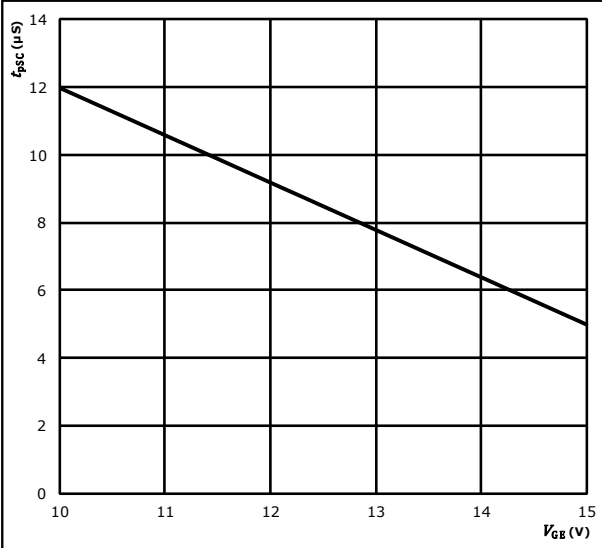

At
 $V_{CE} = 650 \text{ V}$
 $T_j \leq 175 \text{ }^\circ\text{C}$

figure 8. IGBT

Typical short circuit current as a function of VGE

$I_{SC} = f(V_{GE})$

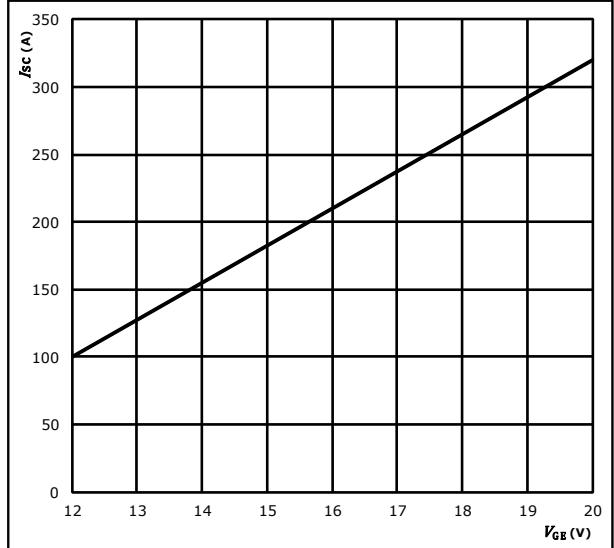

At
 $V_{CE} \leq 650 \text{ V}$
 $T_j \leq 175 \text{ }^\circ\text{C}$



Vincotech

High Boost Diode / Low Boost Diode Characteristics

figure 1. FWD

Typical forward characteristics

$$I_F = f(V_F)$$

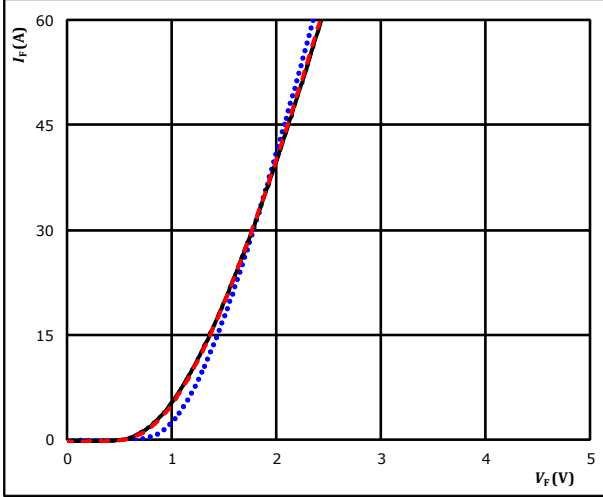

$t_p = 250 \mu s$
 T_j : 25 °C
 125 °C ———
 150 °C - - - -

figure 2. FWD

Transient thermal impedance as a function of pulse width

$$Z_{th(j-s)} = f(t_p)$$

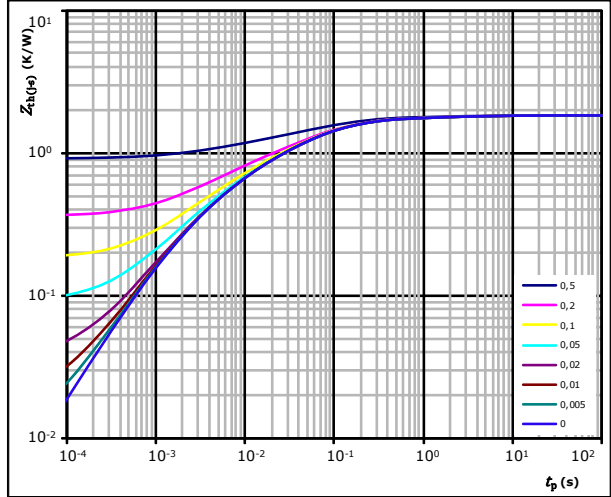

$D = t_p / T$
 $R_{th(j-s)} = 1,82$ K/W

FWD thermal model values

R (K/W)	τ (s)
5,26E-02	5,31E+00
1,17E-01	7,49E-01
5,61E-01	1,08E-01
5,47E-01	3,08E-02
3,91E-01	6,39E-03
1,49E-01	1,43E-03



Vincotech

Input Boost Switch Characteristics

figure 1. IGBT

Typical output characteristics

$$I_C = f(V_{CE})$$

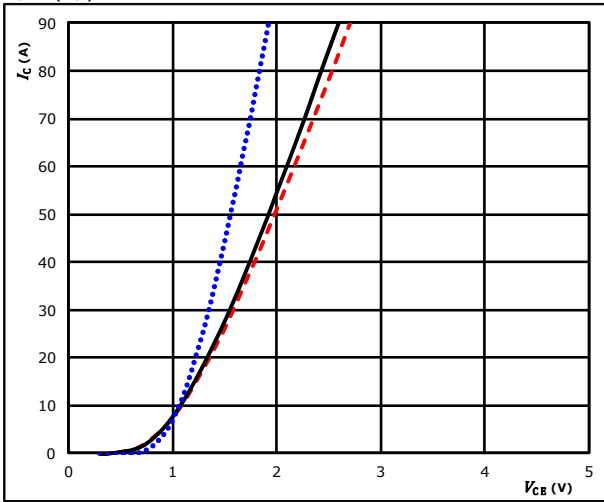

$t_p = 250 \mu\text{s}$
 $V_{GE} = 15 \text{ V}$
 $T_j:$ 25 °C (dotted blue), 125 °C (solid black), 150 °C (dashed red)

figure 2. IGBT

Typical output characteristics

$$I_C = f(V_{CE})$$

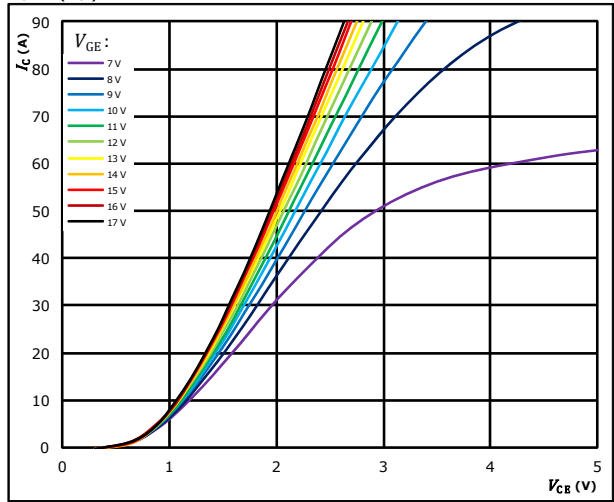

$t_p = 250 \mu\text{s}$
 $T_j = 150 \text{ °C}$
 V_{GE} from 7 V to 17 V in steps of 1 V

figure 3. IGBT

Typical transfer characteristics

$$I_C = f(V_{GE})$$

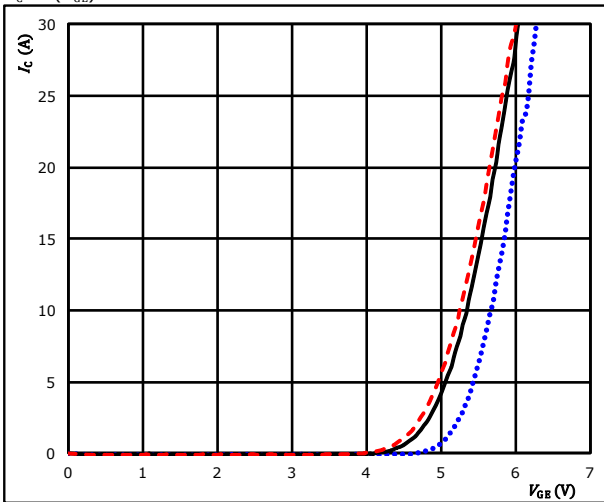

$t_p = 100 \mu\text{s}$
 $V_{CE} = 10 \text{ V}$
 $T_j:$ 25 °C (dotted blue), 125 °C (solid black), 150 °C (dashed red)

figure 4. IGBT

Transient thermal impedance as function of pulse duration

$$Z_{th(j-s)} = f(t_p)$$

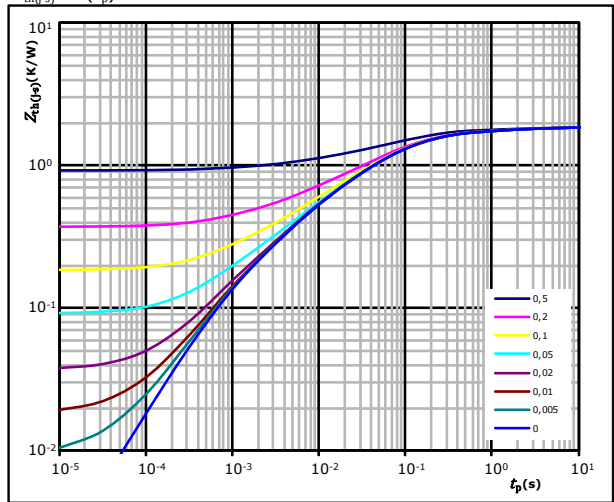

$D = t_p / T$
 $R_{th(j-s)} = 1,86 \text{ K/W}$
 IGBT thermal model values

R (K/W)	τ (s)
1,24E-01	2,76E+00
1,92E-01	4,60E-01
7,76E-01	9,02E-02
4,21E-01	2,36E-02
2,47E-01	5,25E-03
9,60E-02	8,07E-04



Vincotech

Input Boost Switch Characteristics

figure 5. IGBT

Gate voltage vs gate charge

$$V_{GE} = f(Q_G)$$

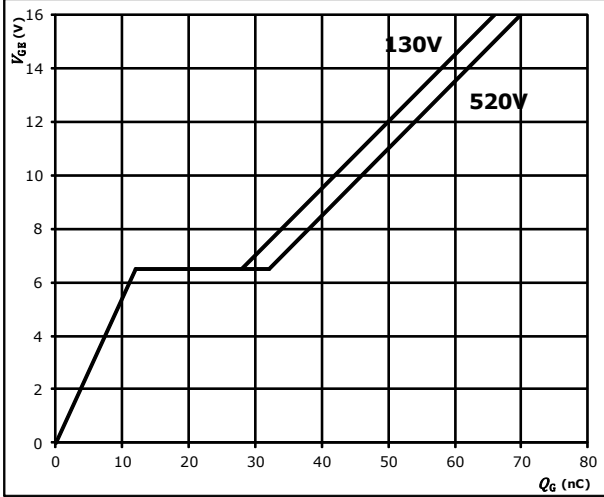

$I_C = 30$ A

figure 6. IGBT

Safe operating area

$$I_C = f(V_{CE})$$

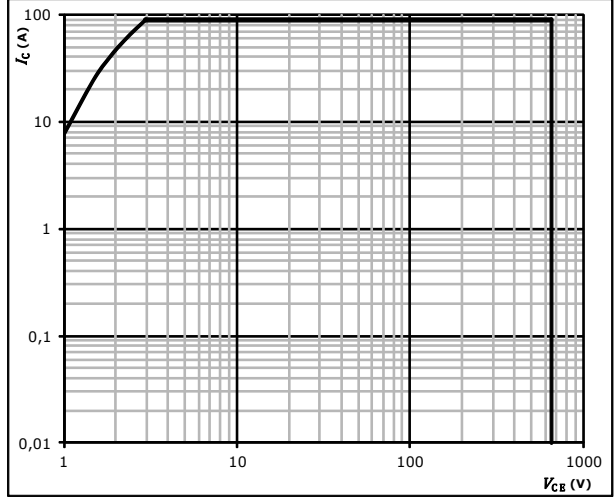

$D =$ single pulse
 $T_s = 80$ °C
 $V_{GE} = \pm 15$ V
 $T_j = T_{jmax}$



Vincotech

Input Boost Diode Characteristics

Typical forward characteristics

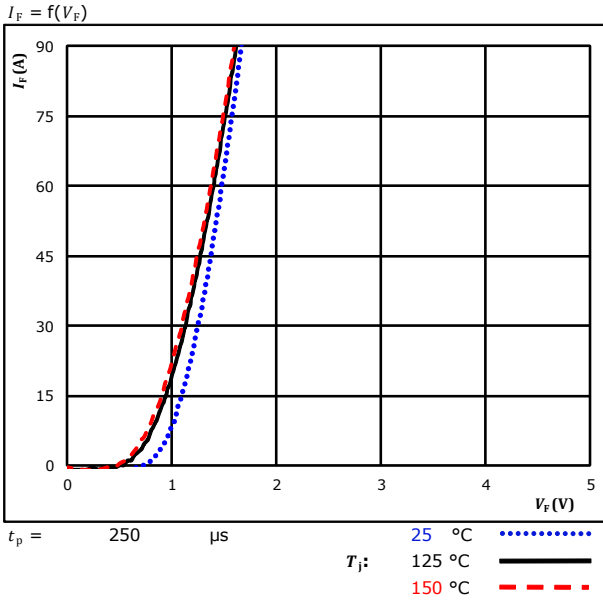

Transient thermal impedance as a function of pulse width

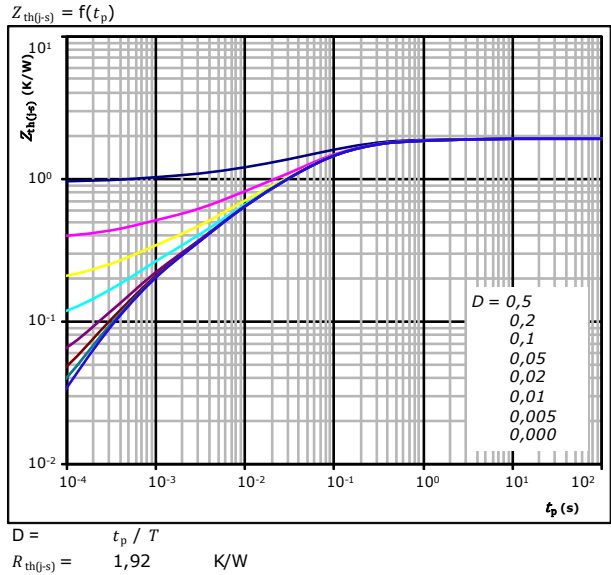

FWD thermal model values

R (K/W)	τ (s)
9,41E-02	2,25E+00
3,44E-01	2,12E-01
8,56E-01	5,84E-02
3,61E-01	9,83E-03
1,37E-01	2,89E-03
1,27E-01	4,79E-04



Vincotech

Input Boost Sw. Protection Diode Characteristics

figure 1. FWD

Typical forward characteristics

$$I_F = f(V_F)$$

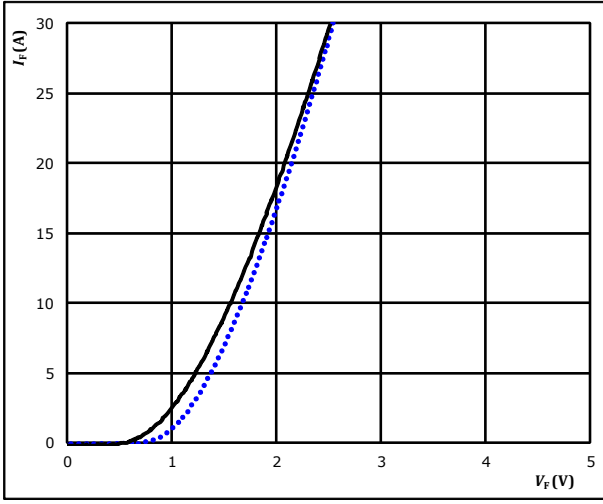

$t_p = 250 \mu s$ $T_j: 25 \text{ } ^\circ\text{C}$ (dotted blue line)
 $125 \text{ } ^\circ\text{C}$ (solid black line)

figure 2. FWD

Transient thermal impedance as a function of pulse width

$$Z_{th(j-s)} = f(t_p)$$

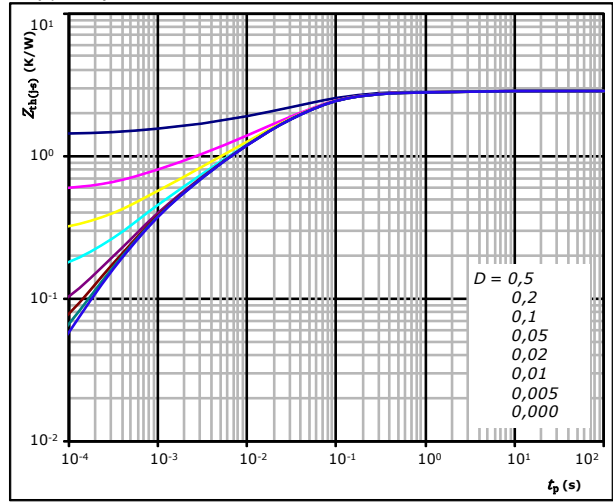

$D = t_p / T$
 $R_{th(j-s)} = 2,87 \text{ K/W}$

FWD thermal model values

R (K/W)	τ (s)
6,53E-02	3,94E+00
1,48E-01	4,48E-01
1,31E+00	5,96E-02
7,32E-01	1,36E-02
4,04E-01	2,79E-03
2,11E-01	5,37E-04



ByPass Diode Characteristics

figure 1. Rectifier Diode
Typical forward characteristics

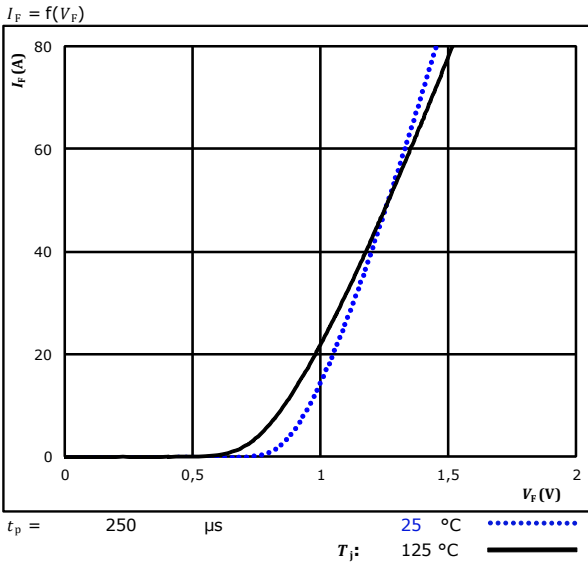
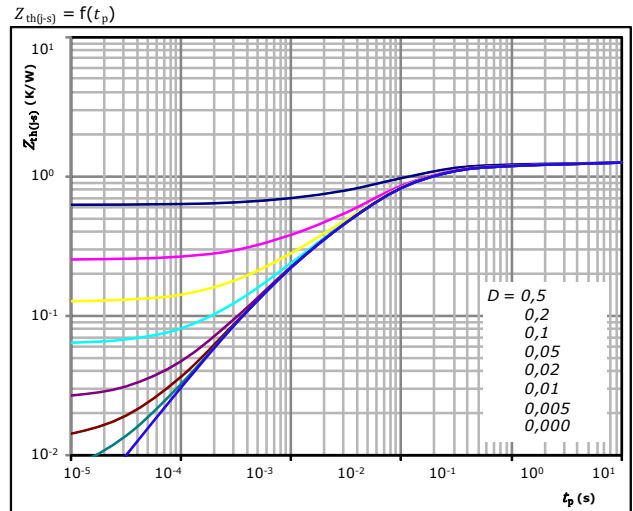

figure 2. Rectifier Diode
Transient thermal impedance as a function of pulse width



$D = \frac{t_p}{T}$
 $R_{th(j-s)} = 1,25 \text{ K/W}$

Diode thermal model values

R (K/W)	τ (s)
8,00E-02	5,22E+00
1,56E-01	4,18E-01
6,95E-01	8,82E-02
2,23E-01	3,07E-02
9,97E-02	5,99E-03

Thermistor Characteristics

figure 1. Thermistor
Typical NTC characteristic as a function of temperature

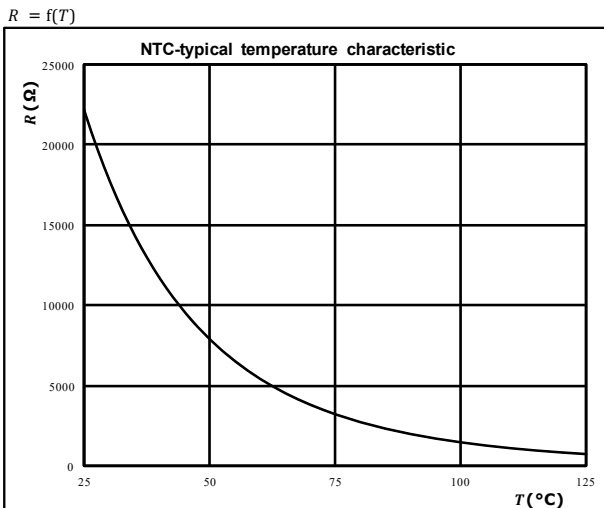



Vincotech

Buck Switching Characteristics

figure 1. IGBT

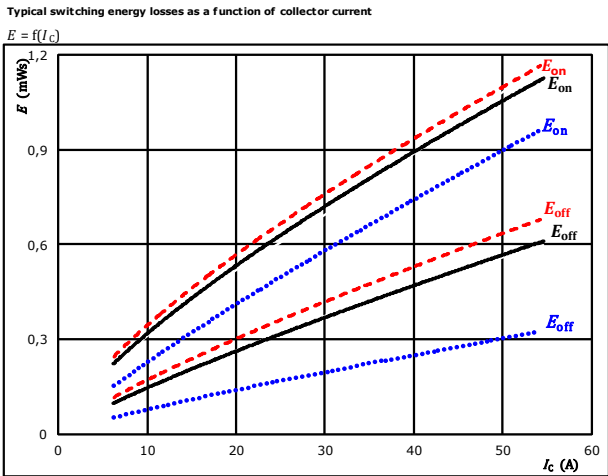

With an inductive load at
 $V_{CE} = 350$ V
 $V_{GE} = \pm 15$ V
 $R_{g(on)} = 16$ Ω
 $R_{g(off)} = 16$ Ω

T_j : 25 °C (dotted blue), 125 °C (solid black), 150 °C (dashed red)

figure 2. IGBT

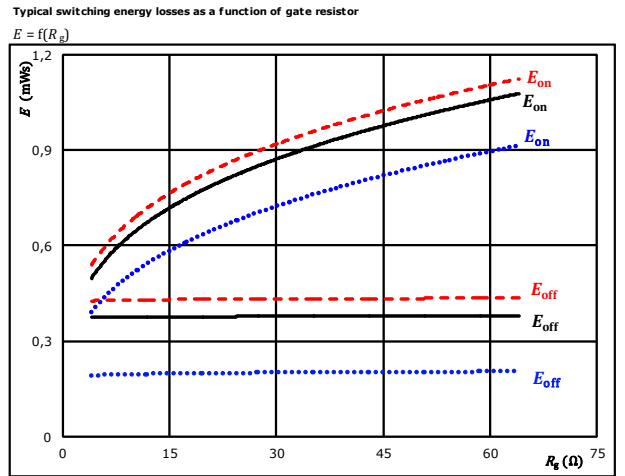

With an inductive load at
 $V_{CE} = 350$ V
 $V_{GE} = \pm 15$ V
 $I_C = 30$ A

T_j : 25 °C (dotted blue), 125 °C (solid black), 150 °C (dashed red)

figure 3. FWD

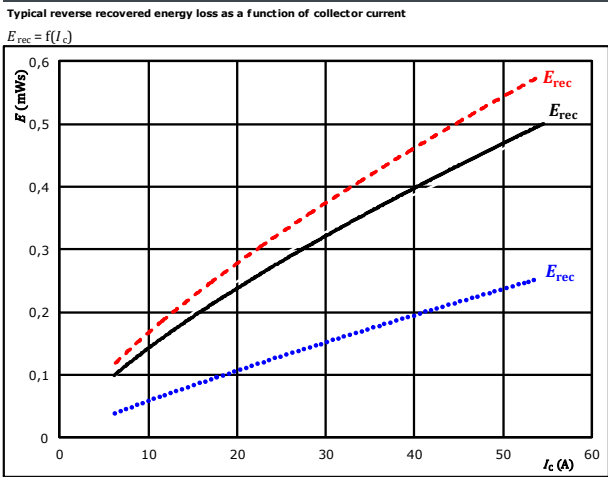

With an inductive load at
 $V_{CE} = 350$ V
 $V_{GE} = \pm 15$ V
 $R_{g(on)} = 16$ Ω

T_j : 25 °C (dotted blue), 125 °C (solid black), 150 °C (dashed red)

figure 4. FWD

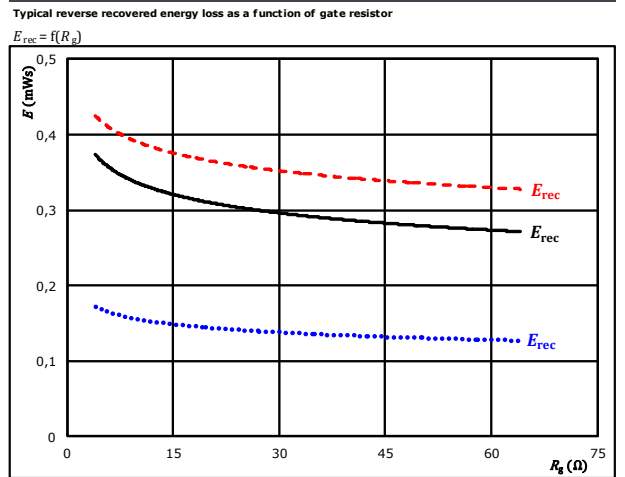

With an inductive load at
 $V_{CE} = 350$ V
 $V_{GE} = \pm 15$ V
 $I_C = 30$ A

T_j : 25 °C (dotted blue), 125 °C (solid black), 150 °C (dashed red)



Vincotech

Buck Switching Characteristics

figure 5. IGBT

Typical switching times as a function of collector current

$$t = f(I_C)$$

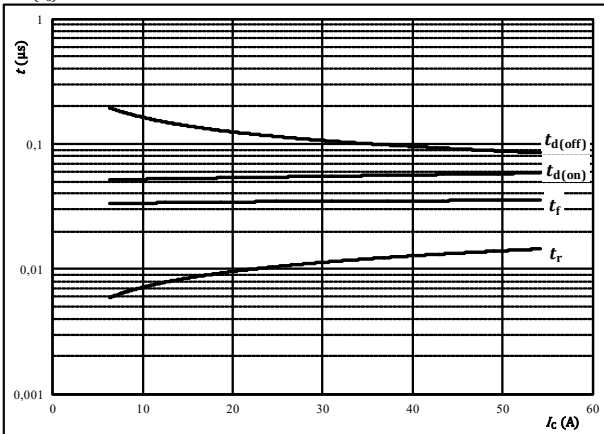

With an inductive load at

$T_j =$	150	°C
$V_{CE} =$	350	V
$V_{GE} =$	±15	V
$R_{g(on)} =$	16	Ω
$R_{g(off)} =$	16	Ω

figure 6. IGBT

Typical switching times as a function of gate resistor

$$t = f(R_g)$$

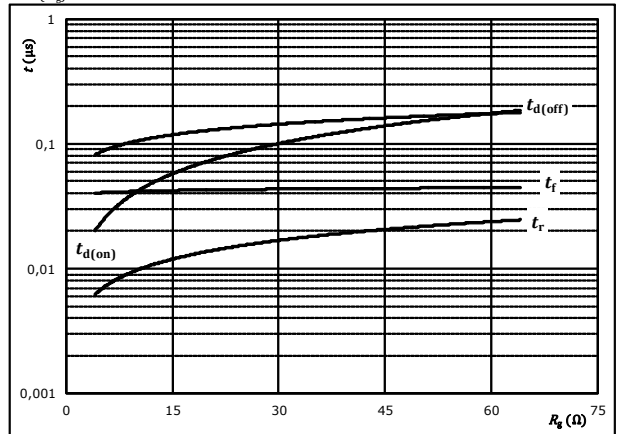

With an inductive load at

$T_j =$	150	°C
$V_{CE} =$	350	V
$V_{GE} =$	±15	V
$I_C =$	30	A

figure 7. FWD

Typical reverse recovery time as a function of collector current

$$t_{rr} = f(I_C)$$

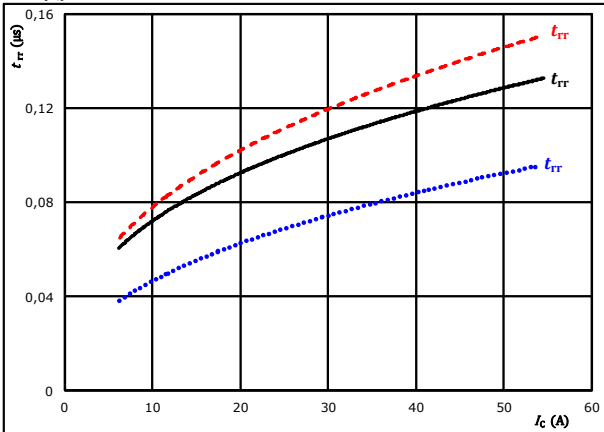

At	$V_{CE} =$	350	V	$T_j:$	25 °C
	$V_{GE} =$	±15	V		125 °C	————
	$R_{g(on)} =$	16	Ω		150 °C	- - - -

figure 8. FWD

Typical reverse recovery time as a function of IGBT turn on gate resistor

$$t_{rr} = f(R_{g(on)})$$

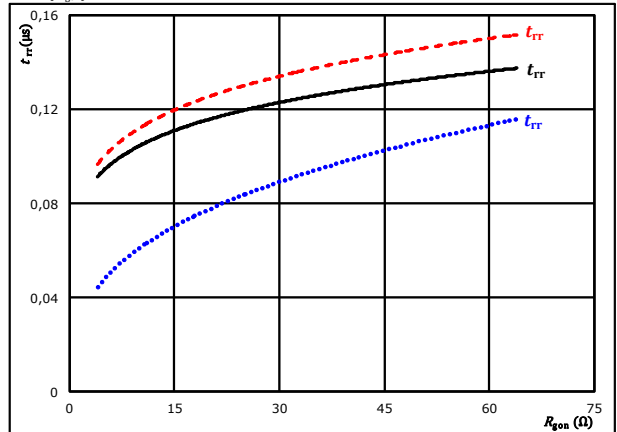

At	$V_{CE} =$	350	V	$T_j:$	25 °C
	$V_{GE} =$	±15	V		125 °C	————
	$I_C =$	30	A		150 °C	- - - -



Vincotech

Buck Switching Characteristics

figure 9. FWD

Typical recovered charge as a function of collector current

$$Q_r = f(I_c)$$

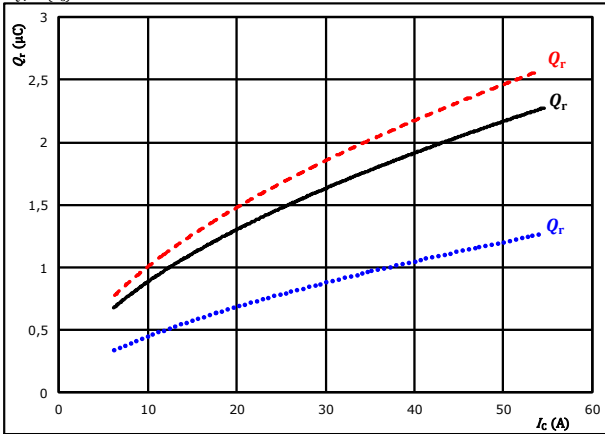

At $V_{CE} = 350$ V
 $V_{GE} = \pm 15$ V
 $R_{gon} = 16$ Ω
 T_j : 25 °C (dotted blue)
 125 °C (solid black)
 150 °C (dashed red)

figure 10. FWD

Typical recovered charge as a function of IGBT turn on gate resistor

$$Q_r = f(R_{gon})$$

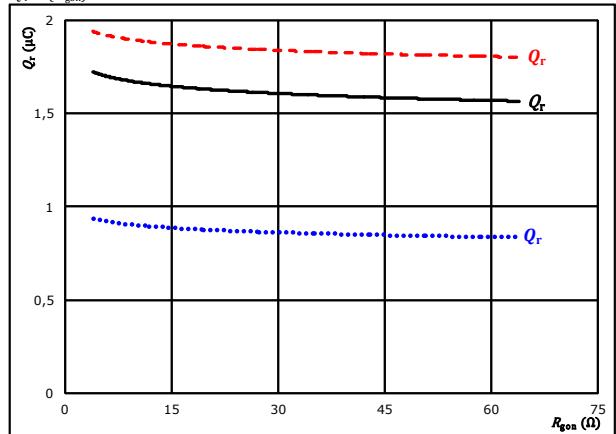

At $V_{CE} = 350$ V
 $V_{GE} = \pm 15$ V
 $I_c = 30$ A
 T_j : 25 °C (dotted blue)
 125 °C (solid black)
 150 °C (dashed red)

figure 11. FWD

Typical peak reverse recovery current as a function of collector current

$$I_{RM} = f(I_c)$$

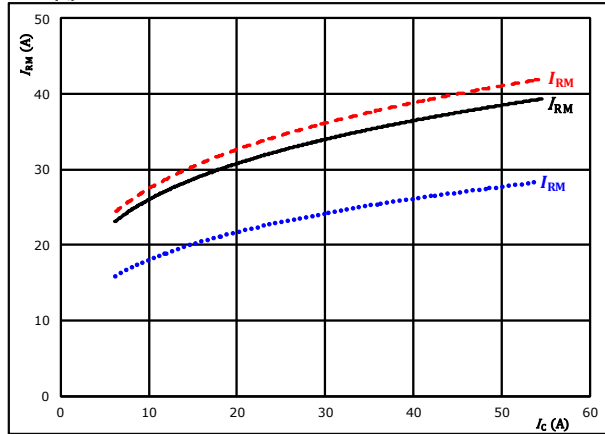

At $V_{CE} = 350$ V
 $V_{GE} = \pm 15$ V
 $R_{gon} = 16$ Ω
 T_j : 25 °C (dotted blue)
 125 °C (solid black)
 150 °C (dashed red)

figure 12. FWD

Typical peak reverse recovery current as a function of IGBT turn on gate resistor

$$I_{RM} = f(R_{gon})$$

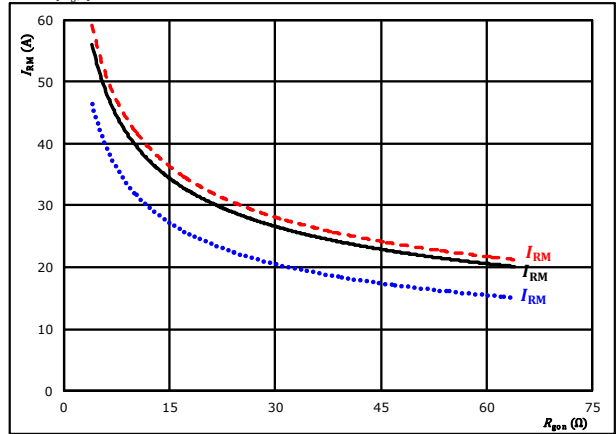

At $V_{CE} = 350$ V
 $V_{GE} = \pm 15$ V
 $I_c = 30$ A
 T_j : 25 °C (dotted blue)
 125 °C (solid black)
 150 °C (dashed red)



Vincotech

Buck Switching Characteristics

figure 13. FWD

Typical rate of fall of forward and reverse recovery current as a function of collector current
 $di_f/dt, di_{rr}/dt = f(I_c)$

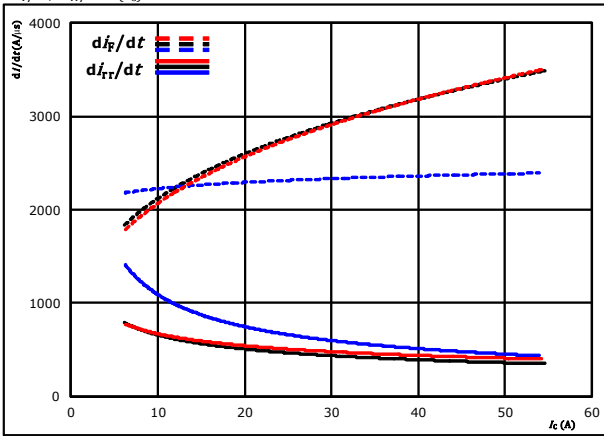

At $V_{CE} = 350$ V $T_j = 25$ °C (dotted blue line)
 $V_{GE} = \pm 15$ V $T_j = 125$ °C (solid black line)
 $R_{g0n} = 16$ Ω $T_j = 150$ °C (dashed red line)

figure 14. FWD

Typical rate of fall of forward and reverse recovery current as a function of IGBT turn on gate resistor
 $di_f/dt, di_{rr}/dt = f(R_{g0n})$

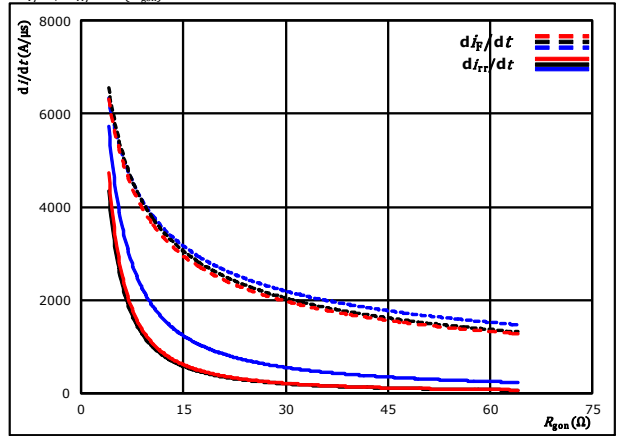

At $V_{CE} = 350$ V $T_j = 25$ °C (dotted blue line)
 $V_{GE} = \pm 15$ V $T_j = 125$ °C (solid black line)
 $I_c = 30$ A $T_j = 150$ °C (dashed red line)

figure 15. IGBT

Reverse bias safe operating area
 $I_c = f(V_{CE})$

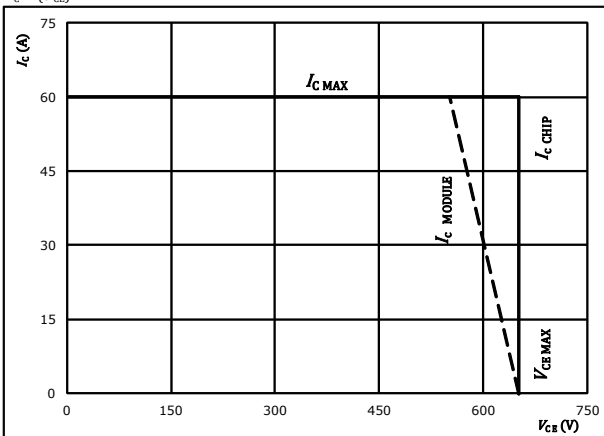

At $T_j = 175$ °C
 $R_{g0n} = 16$ Ω
 $R_{g0ff} = 16$ Ω



Vincotech

Buck Switching Definitions

General conditions		
T_j	=	125 °C
R_{gon}	=	16 Ω
R_{goff}	=	16 Ω

figure 1. IGBT

Turn-off Switching Waveforms & definition of t_{doff} , t_{Eoff} (t_{Eoff} = integrating time for E_{off})

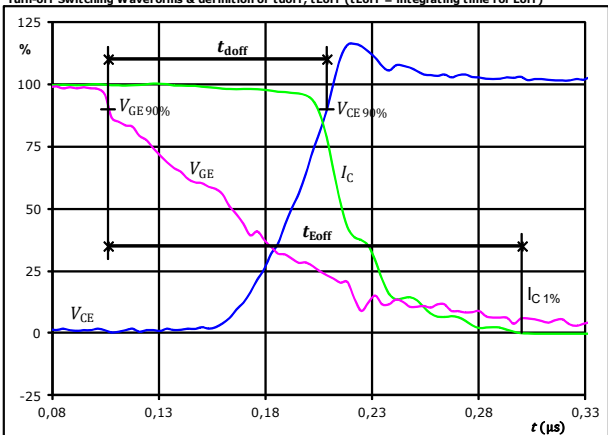

$V_{CE}(0\%) =$	-15	V
$V_{GE}(100\%) =$	15	V
$V_C(100\%) =$	350	V
$I_C(100\%) =$	30	A
$t_{doff} =$	0,101	μs
$t_{Eoff} =$	0,194	μs

figure 3. IGBT

Turn-off Switching Waveforms & definition of t_f

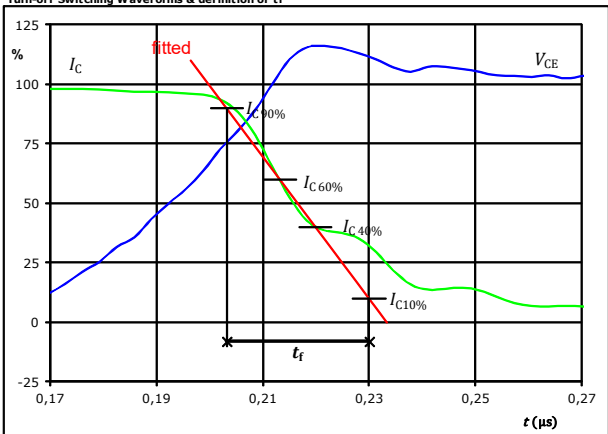

$V_C(100\%) =$	350	V
$I_C(100\%) =$	30	A
$t_f =$	0,031	μs

figure 2. IGBT

Turn-on Switching Waveforms & definition of t_{don} , t_{Eon} (t_{Eon} = integrating time for E_{on})

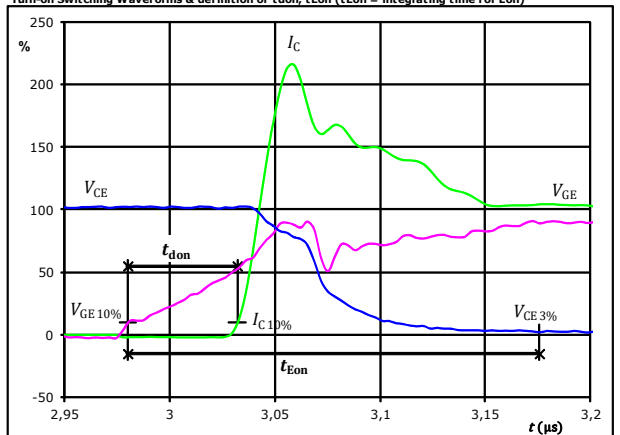

$V_{CE}(0\%) =$	-15	V
$V_{GE}(100\%) =$	15	V
$V_C(100\%) =$	350	V
$I_C(100\%) =$	30	A
$t_{don} =$	0,056	μs
$t_{Eon} =$	0,196	μs

figure 4. IGBT

Turn-on Switching Waveforms & definition of t_r

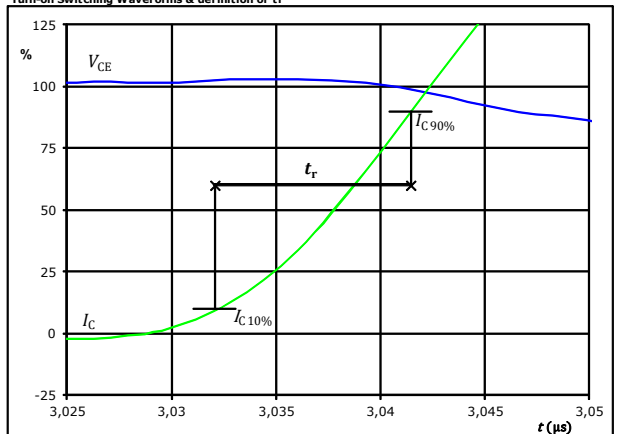

$V_C(100\%) =$	350	V
$I_C(100\%) =$	30	A
$t_r =$	0,010	μs



Vincotech

Buck Switching Characteristics

figure 5. IGBT

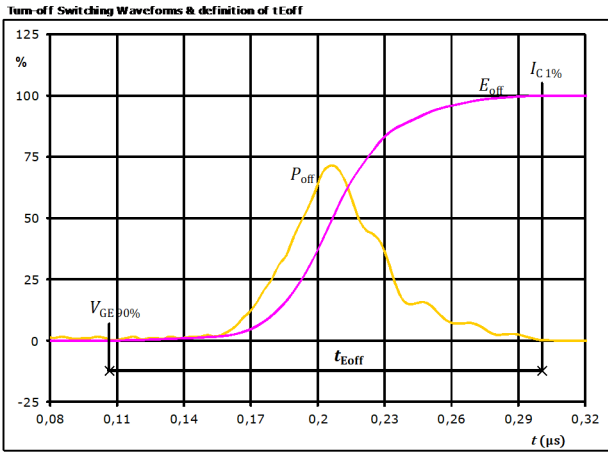

$P_{off}(100\%) = 10,57$ kW
 $E_{off}(100\%) = 0,38$ mJ
 $t_{Eoff} = 0,19$ μs

figure 6. IGBT

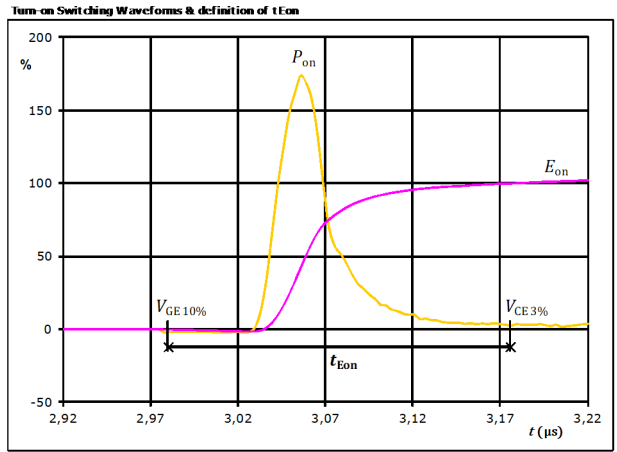

$P_{on}(100\%) = 10,57$ kW
 $E_{on}(100\%) = 0,70$ mJ
 $t_{Eon} = 0,20$ μs

figure 7. FWD

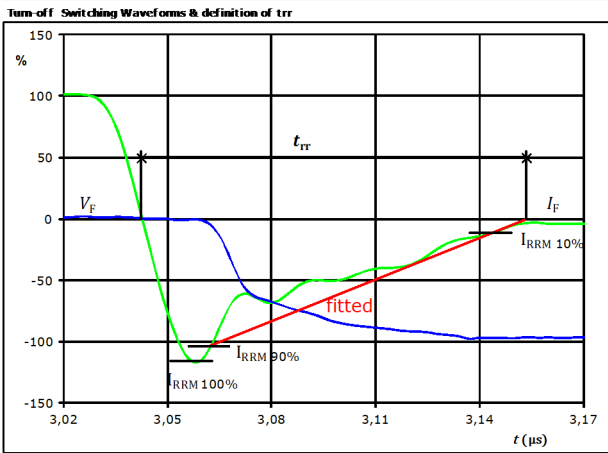

$V_F(100\%) = 350$ V
 $I_F(100\%) = 30$ A
 $I_{RRM}(100\%) = -33$ A
 $t_{tr} = 0,110$ μs



Vincotech

Buck Switching Characteristics

figure 8. FWD

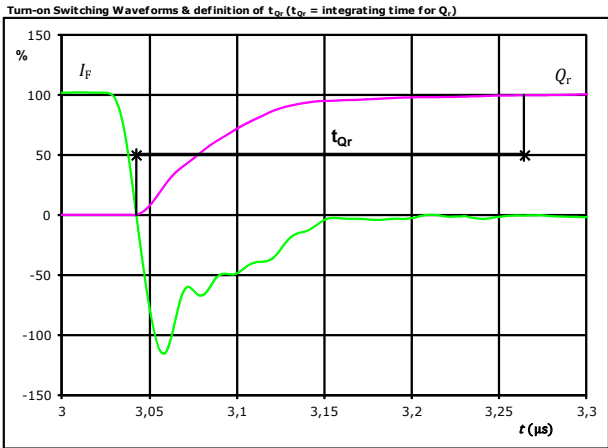

I_F (100%) = 30 A
 Q_r (100%) = 1,66 μ C
 t_{Qr} = 0,22 μ s

figure 9. FWD

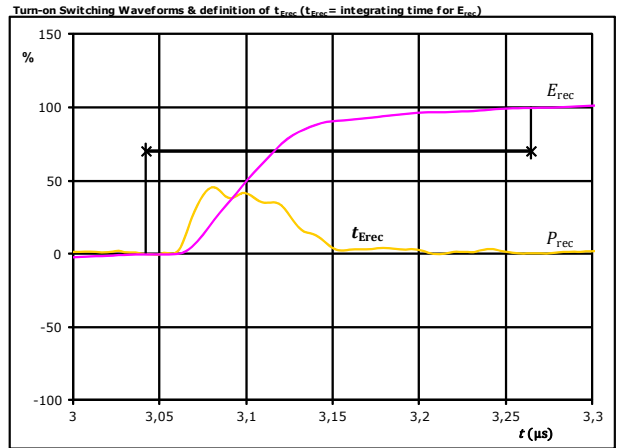

P_{rec} (100%) = 10,57 kW
 E_{rec} (100%) = 0,33 mJ
 t_{Erec} = 0,22 μ s



Vincotech

Boost Switching Characteristics

figure 1. IGBT

Typical switching energy losses as a function of collector current

$$E = f(I_C)$$

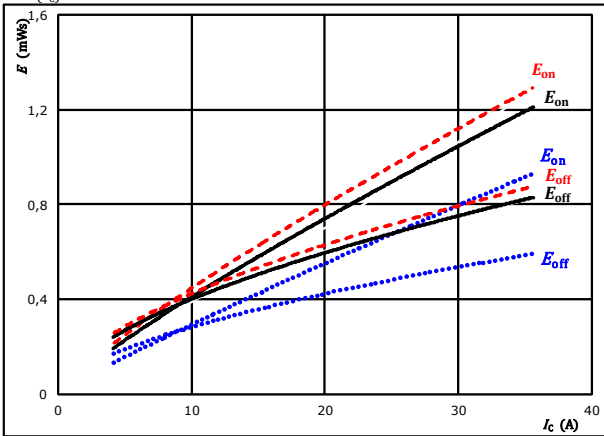

With an inductive load at

$V_{CE} = 350$ V	$T_j: 25$ °C
$V_{GE} = \pm 15$ V	125 °C	————
$R_{g\text{on}} = 16$ Ω	150 °C	-----
$R_{g\text{off}} = 16$ Ω		

figure 2. IGBT

Typical switching energy losses as a function of gate resistor

$$E = f(R_g)$$

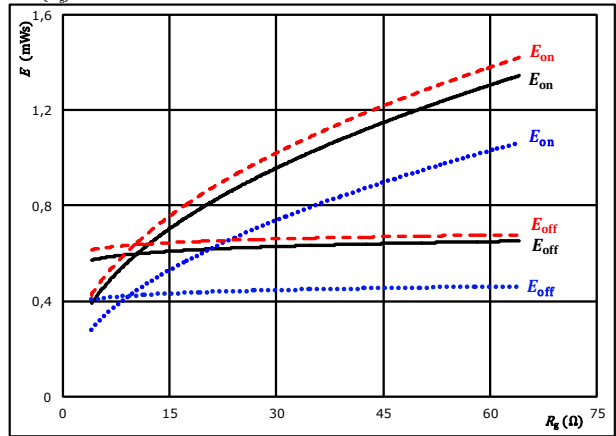

With an inductive load at

$V_{CE} = 350$ V	$T_j: 25$ °C
$V_{GE} = \pm 15$ V	125 °C	————
$I_C = 20$ A	150 °C	-----

figure 3. FWD

Typical reverse recovered energy loss as a function of collector current

$$E_{rec} = f(I_C)$$

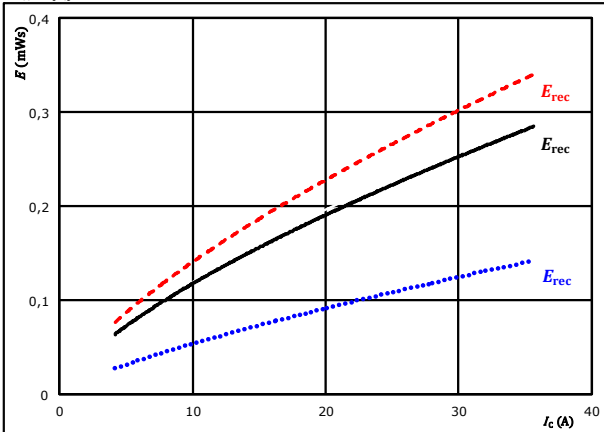

With an inductive load at

$V_{CE} = 350$ V	$T_j: 25$ °C
$V_{GE} = \pm 15$ V	125 °C	————
$R_{g\text{on}} = 16$ Ω	150 °C	-----

figure 4. FWD

Typical reverse recovered energy loss as a function of gate resistor

$$E_{rec} = f(R_g)$$

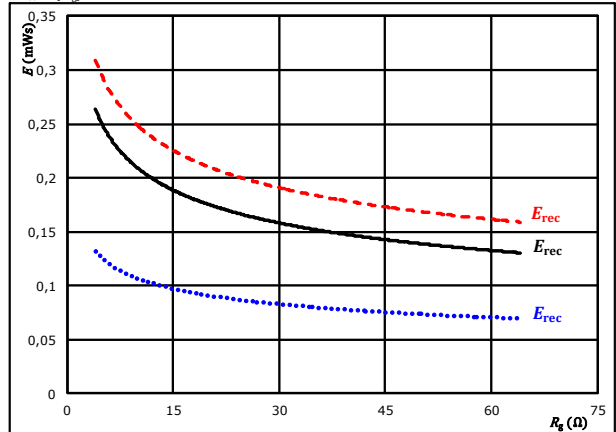

With an inductive load at

$V_{CE} = 350$ V	$T_j: 25$ °C
$V_{GE} = \pm 15$ V	125 °C	————
$I_C = 20$ A	150 °C	-----



Vincotech

Boost Switching Characteristics

figure 5. IGBT

Typical switching times as a function of collector current

$$t = f(I_C)$$

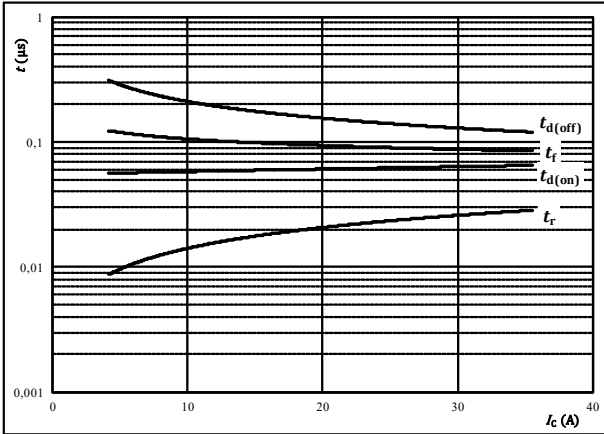

With an inductive load at

$T_j =$	150	°C
$V_{CE} =$	350	V
$V_{GE} =$	±15	V
$R_{g(on)} =$	16	Ω
$R_{g(off)} =$	16	Ω

figure 6. IGBT

Typical switching times as a function of gate resistor

$$t = f(R_g)$$

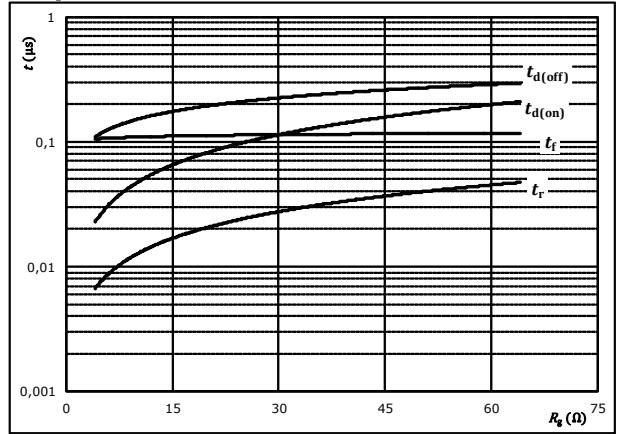

With an inductive load at

$T_j =$	150	°C
$V_{CE} =$	350	V
$V_{GE} =$	±15	V
$I_C =$	20	A

figure 7. FWD

Typical reverse recovery time as a function of collector current

$$t_{rr} = f(I_C)$$

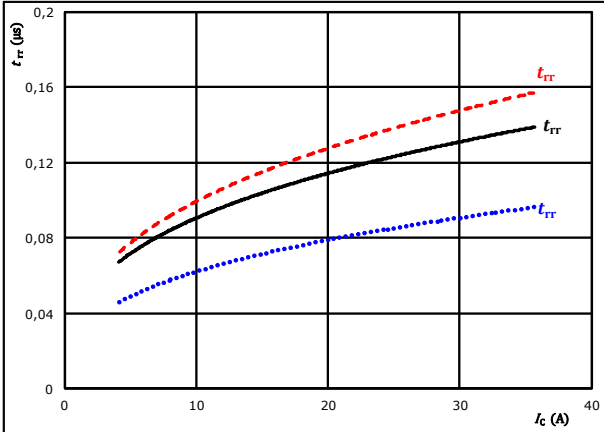

At	$V_{CE} =$	350	V	$T_j:$	25 °C
	$V_{GE} =$	±15	V		125 °C	————
	$R_{g(on)} =$	16	Ω		150 °C	- - - -

figure 8. FWD

Typical reverse recovery time as a function of IGBT turn on gate resistor

$$t_{rr} = f(R_{g(on)})$$

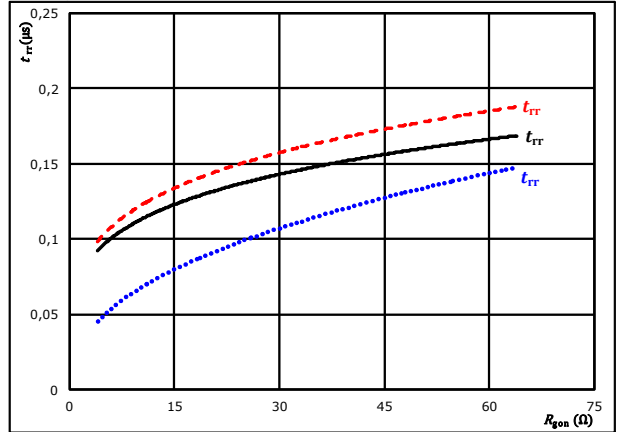

At	$V_{CE} =$	350	V	$T_j:$	25 °C
	$V_{GE} =$	±15	V		125 °C	————
	$I_C =$	20	A		150 °C	- - - -



Vincotech

Boost Switching Characteristics

figure 9. FWD

Typical recovered charge as a function of collector current

$$Q_r = f(I_c)$$

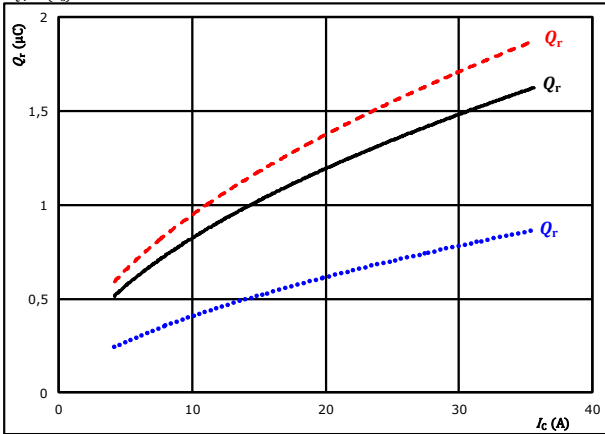

At $V_{CE} = 350$ V $T_j: 25$ °C
 $V_{GE} = \pm 15$ V $T_j: 125$ °C ———
 $R_{gon} = 16$ Ω $T_j: 150$ °C - - - - -

figure 10. FWD

Typical recovered charge as a function of IGBT turn on gate resistor

$$Q_r = f(R_{gon})$$

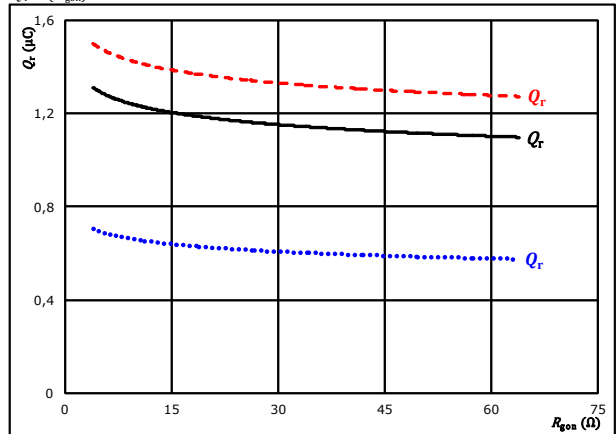

At $V_{CE} = 350$ V $T_j: 25$ °C
 $V_{GE} = \pm 15$ V $T_j: 125$ °C ———
 $I_c = 20$ A $T_j: 150$ °C - - - - -

figure 11. FWD

Typical peak reverse recovery current current as a function of collector current

$$I_{RM} = f(I_c)$$

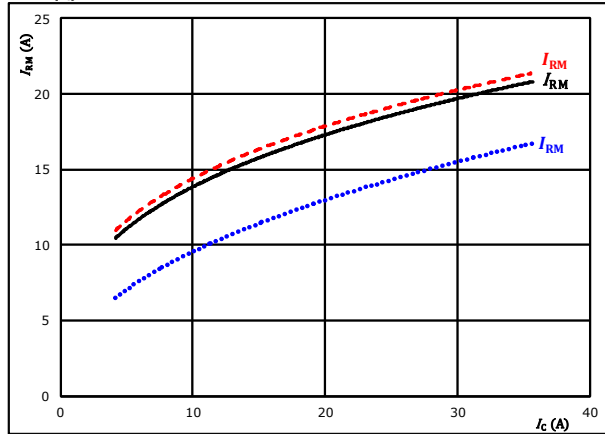

At $V_{CE} = 350$ V $T_j: 25$ °C
 $V_{GE} = \pm 15$ V $T_j: 125$ °C ———
 $R_{gon} = 16$ Ω $T_j: 150$ °C - - - - -

figure 12. FWD

Typical peak reverse recovery current as a function of IGBT turn on gate resistor

$$I_{RM} = f(R_{gon})$$

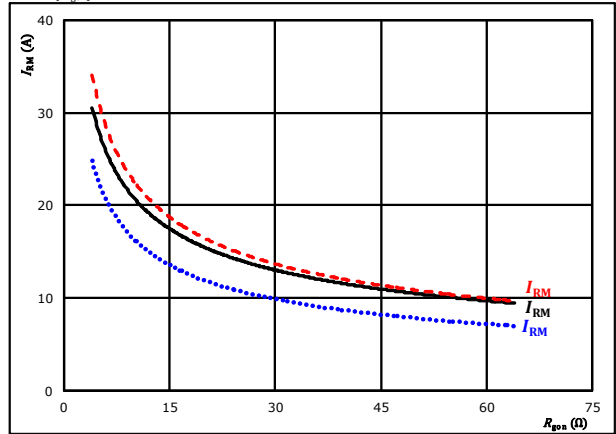

At $V_{CE} = 350$ V $T_j: 25$ °C
 $V_{GE} = \pm 15$ V $T_j: 125$ °C ———
 $I_c = 20$ A $T_j: 150$ °C - - - - -



Vincotech

Boost Switching Characteristics

figure 13. FWD

Typical rate of fall of forward and reverse recovery current as a function of collector current
 $di_f/dt, di_{rr}/dt = f(I_C)$

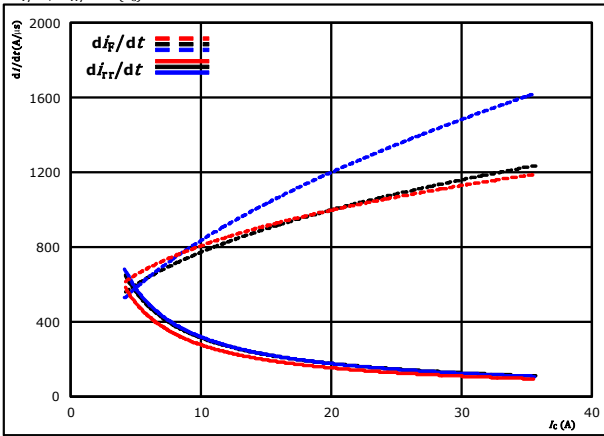

At $V_{CE} = 350$ V $T_j = 25$ °C (dotted)
 $V_{GE} = \pm 15$ V $T_j = 125$ °C (solid)
 $R_{gpn} = 16$ Ω $T_j = 150$ °C (dashed)

figure 14. FWD

Typical rate of fall of forward and reverse recovery current as a function of IGBT turn on gate resistor
 $di_f/dt, di_{rr}/dt = f(R_{gpn})$

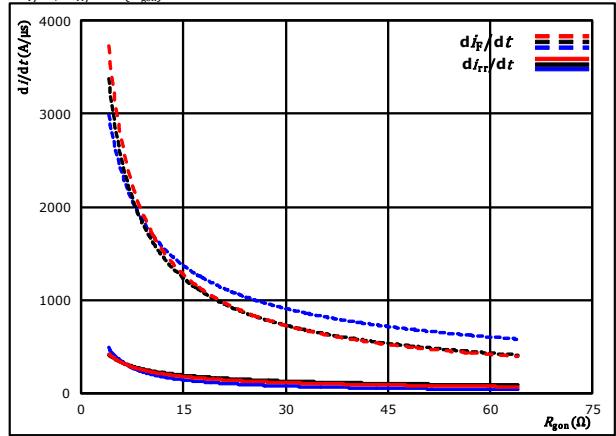

At $V_{CE} = 350$ V $T_j = 25$ °C (dotted)
 $V_{GE} = \pm 15$ V $T_j = 125$ °C (solid)
 $I_C = 20$ A $T_j = 150$ °C (dashed)

figure 15. IGBT

Reverse bias safe operating area
 $I_C = f(V_{CB})$

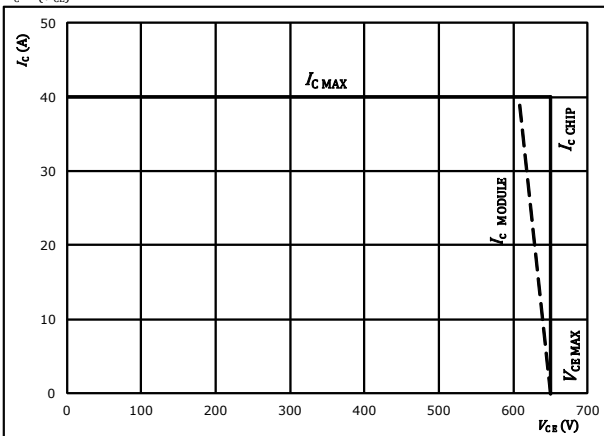

At $T_j = 175$ °C
 $R_{gpn} = 16$ Ω
 $R_{goff} = 16$ Ω



Vincotech

Boost Switching Definitions

General conditions		
T_j	=	125 °C
R_{gon}	=	16 Ω
R_{goff}	=	16 Ω

figure 1. IGBT

Turn-off Switching Waveforms & definition of t_{doff} , t_{Eoff} (t_{Eoff} = integrating time for E_{off})

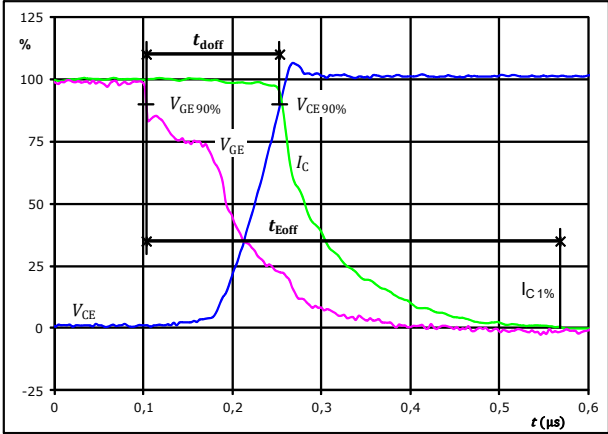

$V_{CE}(0\%) =$	-15	V
$V_{GE}(100\%) =$	15	V
$V_C(100\%) =$	350	V
$I_C(100\%) =$	20	A
$t_{doff} =$	0,150	μs
$t_{Eoff} =$	0,465	μs

figure 2. IGBT

Turn-on Switching Waveforms & definition of t_{don} , t_{Eon} (t_{Eon} = integrating time for E_{on})

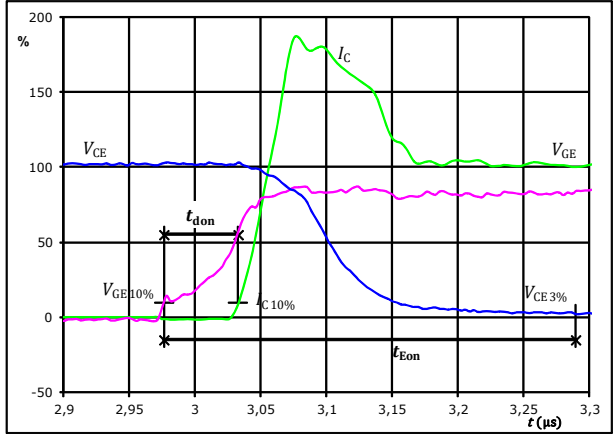

$V_{CE}(0\%) =$	-15	V
$V_{GE}(100\%) =$	15	V
$V_C(100\%) =$	350	V
$I_C(100\%) =$	20	A
$t_{don} =$	0,061	μs
$t_{Eon} =$	0,313	μs

figure 3. IGBT

Turn-off Switching Waveforms & definition of t_f

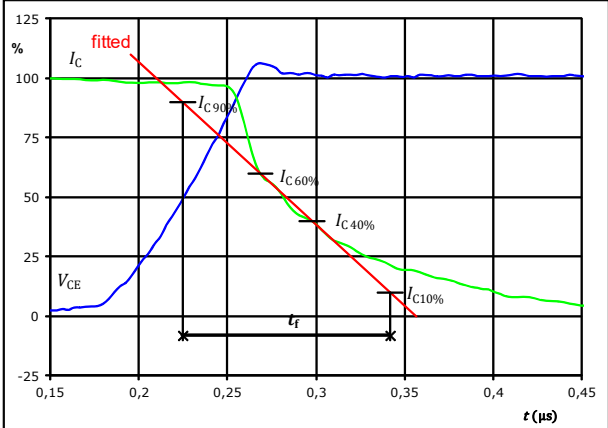

$V_C(100\%) =$	350	V
$I_C(100\%) =$	20	A
$t_f =$	0,105	μs

figure 4. IGBT

Turn-on Switching Waveforms & definition of t_r

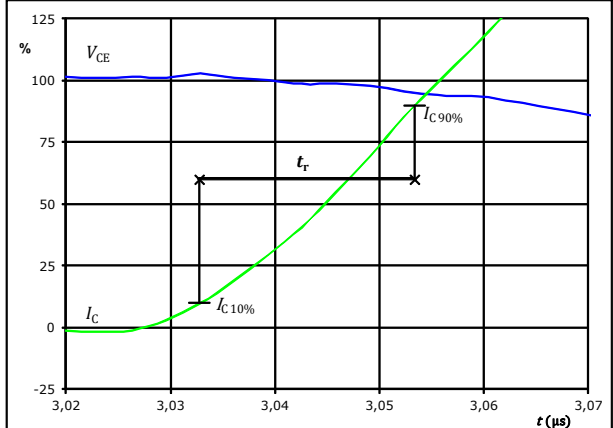

$V_C(100\%) =$	350	V
$I_C(100\%) =$	20	A
$t_r =$	0,021	μs



Vincotech

Boost Switching Characteristics

figure 5. IGBT

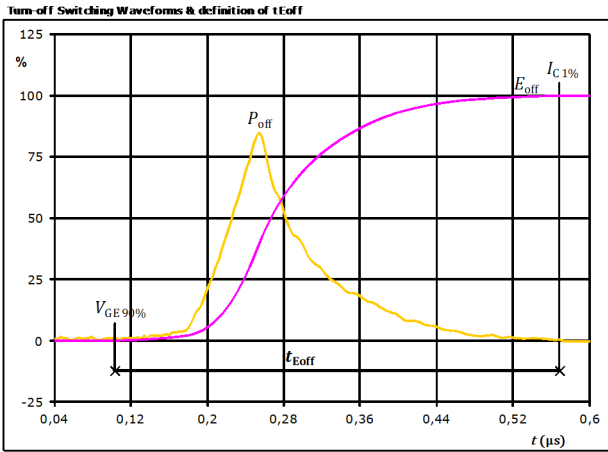

$P_{off}(100\%) = 7,03$ kW
 $E_{off}(100\%) = 0,61$ mJ
 $t_{Eoff} = 0,47$ μs

figure 6. IGBT

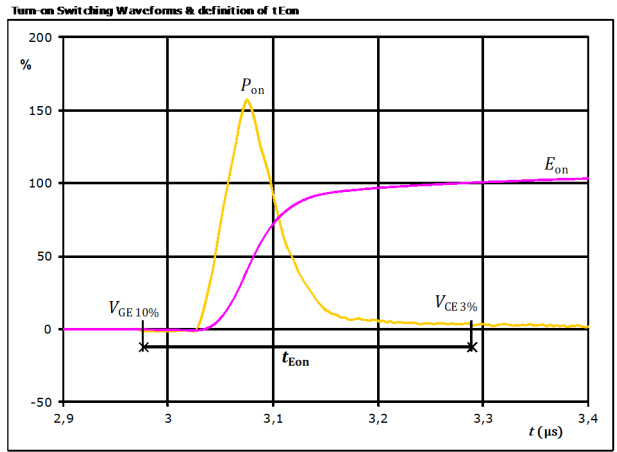

$P_{on}(100\%) = 7,03$ kW
 $E_{on}(100\%) = 0,71$ mJ
 $t_{Eon} = 0,31$ μs

figure 7. FWD

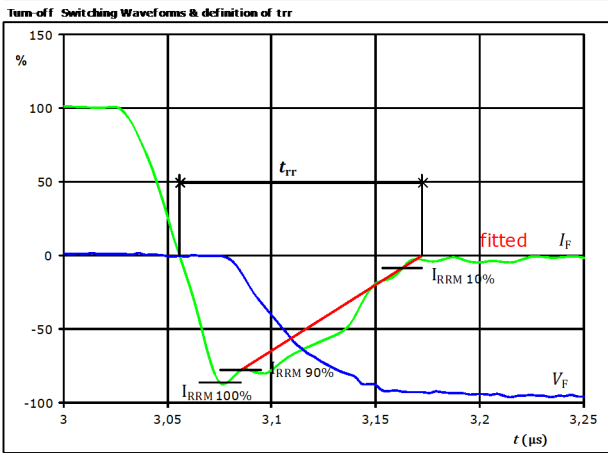

$V_F(100\%) = 350$ V
 $I_F(100\%) = 20$ A
 $I_{RRM}(100\%) = -17$ A
 $t_{rr} = 0,114$ μs



Vincotech

Boost Switching Characteristics

figure 8. FWD

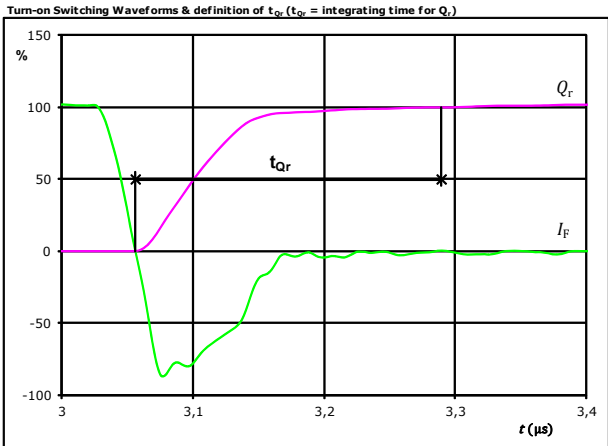

I_F (100%) =	20	A
Q_r (100%) =	1,20	μC
t_{Qr} =	0,23	μs

figure 9. FWD

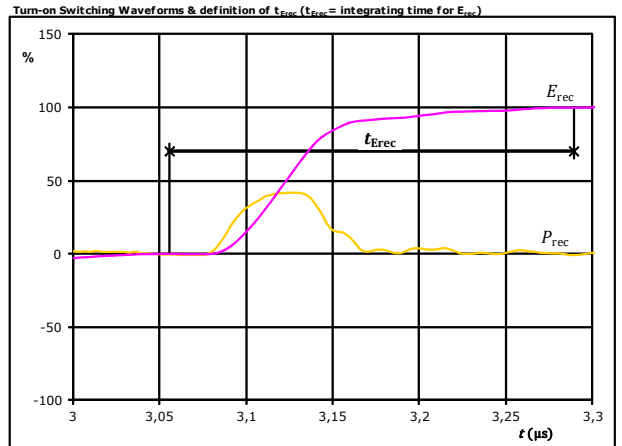

P_{rec} (100%) =	7,03	kW
E_{rec} (100%) =	0,20	mJ
t_{Erec} =	0,23	μs



Vincotech

Input Boost Switching Characteristics

figure 1. IGBT

Typical switching energy losses as a function of collector current

$$E = f(I_c)$$

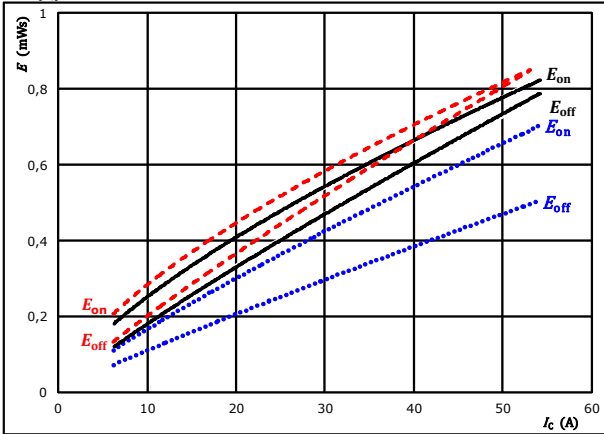

With an inductive load at
 $V_{CE} = 350$ V
 $V_{GE} = \pm 15$ V
 $R_{g\text{on}} = 16$ Ω
 $R_{g\text{off}} = 16$ Ω

T_j : 25 °C (dotted blue)
 125 °C (solid black)
 150 °C (dashed red)

figure 2. IGBT

Typical switching energy losses as a function of gate resistor

$$E = f(R_g)$$

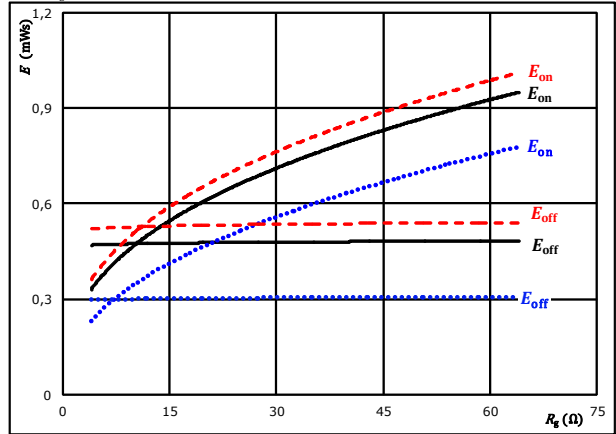

With an inductive load at
 $V_{CE} = 350$ V
 $V_{GE} = \pm 15$ V
 $I_c = 30$ A

T_j : 25 °C (dotted blue)
 125 °C (solid black)
 150 °C (dashed red)

figure 3. FWD

Typical reverse recovered energy loss as a function of collector current

$$E_{rec} = f(I_c)$$

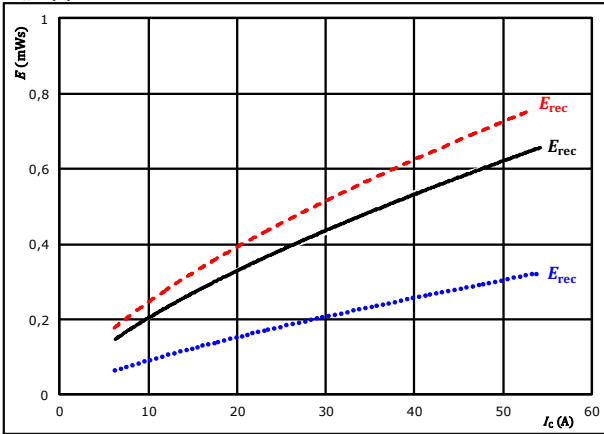

With an inductive load at
 $V_{CE} = 350$ V
 $V_{GE} = \pm 15$ V
 $R_{g\text{on}} = 16$ Ω

T_j : 25 °C (dotted blue)
 125 °C (solid black)
 150 °C (dashed red)

figure 4. FWD

Typical reverse recovered energy loss as a function of gate resistor

$$E_{rec} = f(R_g)$$

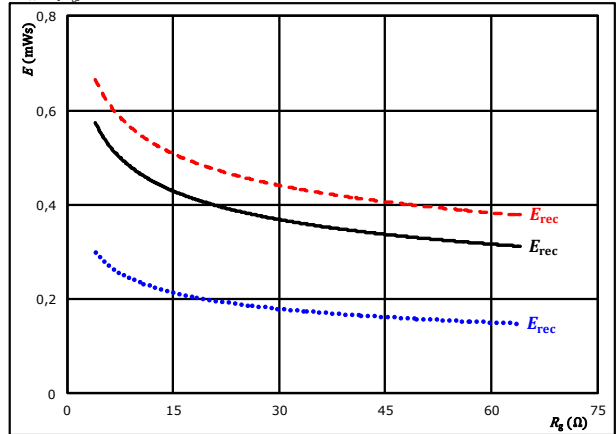

With an inductive load at
 $V_{CE} = 350$ V
 $V_{GE} = \pm 15$ V
 $I_c = 30$ A

T_j : 25 °C (dotted blue)
 125 °C (solid black)
 150 °C (dashed red)



Vincotech

Input Boost Switching Characteristics

figure 5. IGBT

Typical switching times as a function of collector current

$$t = f(I_C)$$

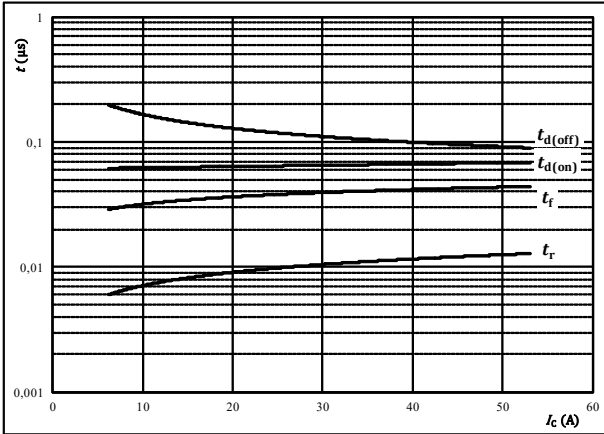

With an inductive load at

$T_j =$	150	°C
$V_{CE} =$	350	V
$V_{GE} =$	±15	V
$R_{gon} =$	16	Ω
$R_{goff} =$	16	Ω

figure 6. IGBT

Typical switching times as a function of gate resistor

$$t = f(R_g)$$

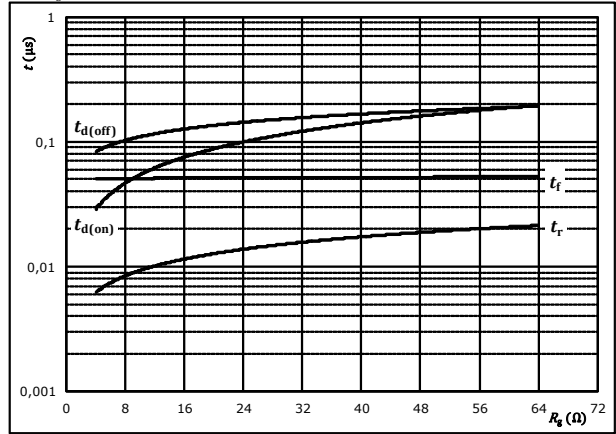

With an inductive load at

$T_j =$	150	°C
$V_{CE} =$	350	V
$V_{GE} =$	±15	V
$I_C =$	30	A

figure 7. FWD

Typical reverse recovery time as a function of collector current

$$t_{rr} = f(I_C)$$

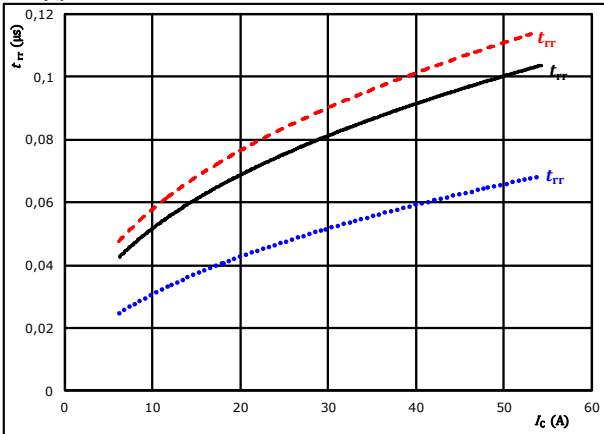

At	$V_{CE} =$	350	V	$T_j:$	25 °C
	$V_{GE} =$	±15	V		125 °C	————
	$R_{gon} =$	16	Ω		150 °C	- - - -

figure 8. FWD

Typical reverse recovery time as a function of IGBT turn on gate resistor

$$t_{rr} = f(R_{gon})$$

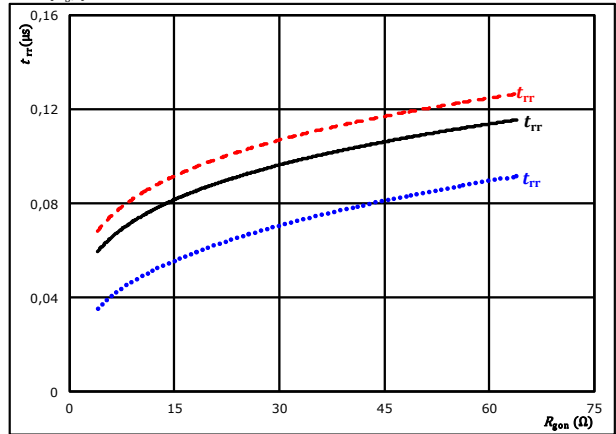

At	$V_{CE} =$	350	V	$T_j:$	25 °C
	$V_{GE} =$	±15	V		125 °C	————
	$I_C =$	30	A		150 °C	- - - -



Vincotech

Input Boost Switching Characteristics

figure 9. FWD

Typical recovered charge as a function of collector current

$$Q_r = f(I_c)$$

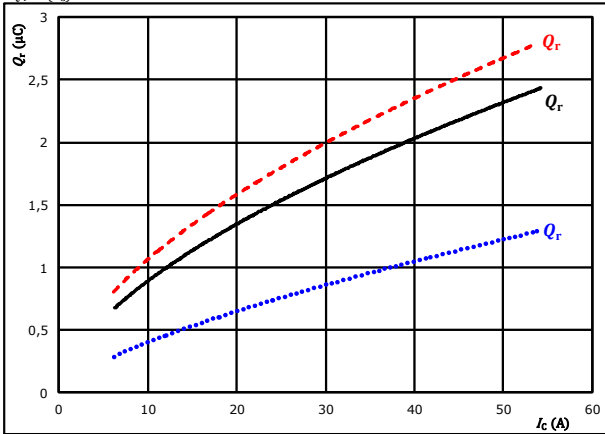

At $V_{CE} = 350$ V
 $V_{GE} = \pm 15$ V
 $R_{gon} = 16$ Ω
 $T_j: 25$ °C (dotted blue)
 125 °C (solid black)
 150 °C (dashed red)

figure 10. FWD

Typical recovered charge as a function of IGBT turn on gate resistor

$$Q_r = f(R_{gon})$$

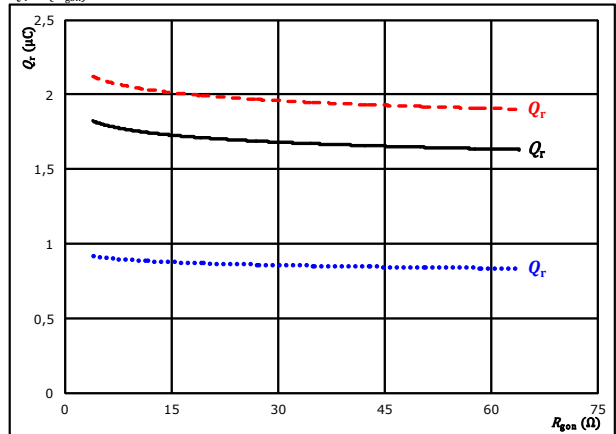

At $V_{CE} = 350$ V
 $V_{GE} = \pm 15$ V
 $I_c = 30$ A
 $T_j: 25$ °C (dotted blue)
 125 °C (solid black)
 150 °C (dashed red)

figure 11. FWD

Typical peak reverse recovery current as a function of collector current

$$I_{RM} = f(I_c)$$

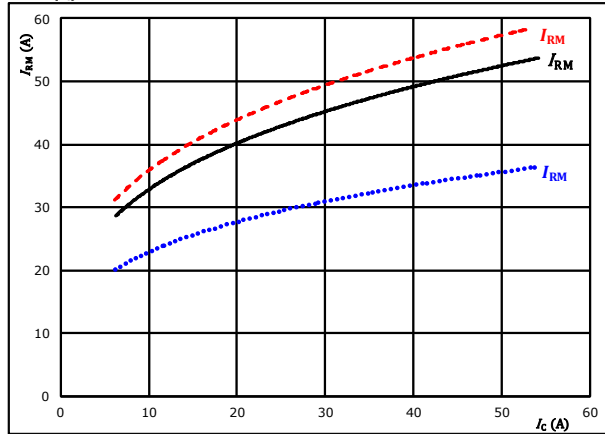

At $V_{CE} = 350$ V
 $V_{GE} = \pm 15$ V
 $R_{gon} = 16$ Ω
 $T_j: 25$ °C (dotted blue)
 125 °C (solid black)
 150 °C (dashed red)

figure 12. FWD

Typical peak reverse recovery current as a function of IGBT turn on gate resistor

$$I_{RM} = f(R_{gon})$$

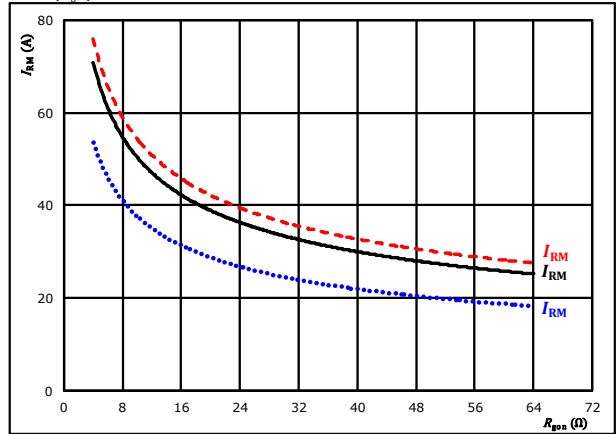

At $V_{CE} = 350$ V
 $V_{GE} = \pm 15$ V
 $I_c = 30$ A
 $T_j: 25$ °C (dotted blue)
 125 °C (solid black)
 150 °C (dashed red)



Vincotech

Input Boost Switching Characteristics

figure 13. FWD

Typical rate of fall of forward and reverse recovery current as a function of collector current
 $di_f/dt, di_{rr}/dt = f(I_c)$

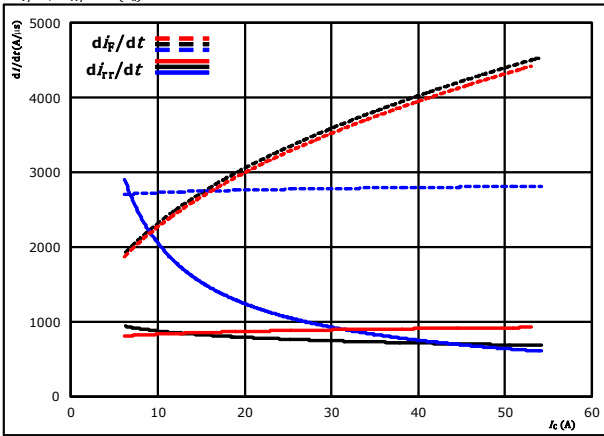

At $V_{CE} = 350$ V $T_j = 25$ °C (dotted blue)
 $V_{GE} = \pm 15$ V $T_j = 125$ °C (solid black)
 $R_{gpn} = 16$ Ω $T_j = 150$ °C (dashed red)

figure 14. FWD

Typical rate of fall of forward and reverse recovery current as a function of IGBT turn on gate resistor
 $di_f/dt, di_{rr}/dt = f(R_{gpn})$

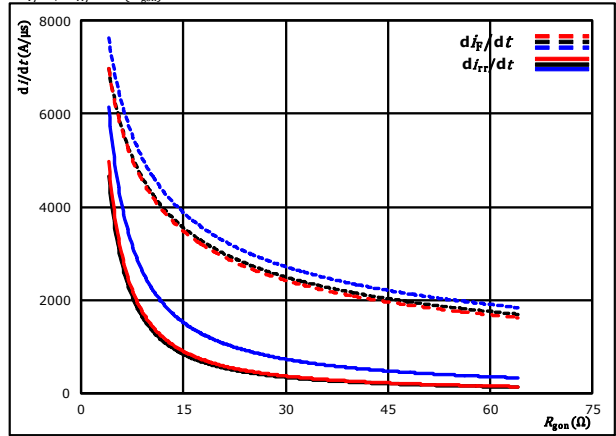

At $V_{CE} = 350$ V $T_j = 25$ °C (dotted blue)
 $V_{GE} = \pm 15$ V $T_j = 125$ °C (solid black)
 $I_c = 30$ A $T_j = 150$ °C (dashed red)

figure 15. IGBT

Reverse bias safe operating area
 $I_c = f(V_{CB})$

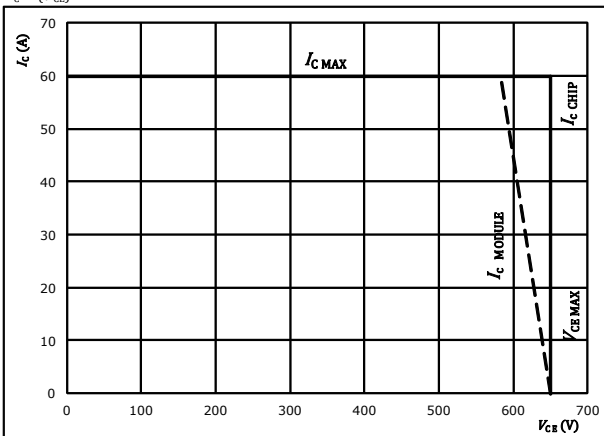

At $T_j = 175$ °C
 $R_{gpn} = 16$ Ω
 $R_{goff} = 16$ Ω



Vincotech

Input Boost Switching Definitions

General conditions

T_j	=	125 °C
R_{gon}	=	16 Ω
R_{goff}	=	16 Ω

figure 1. IGBT

Turn-off Switching Waveforms & definition of t_{doff} , t_{Eoff} (t_{Eoff} = integrating time for Eoff)

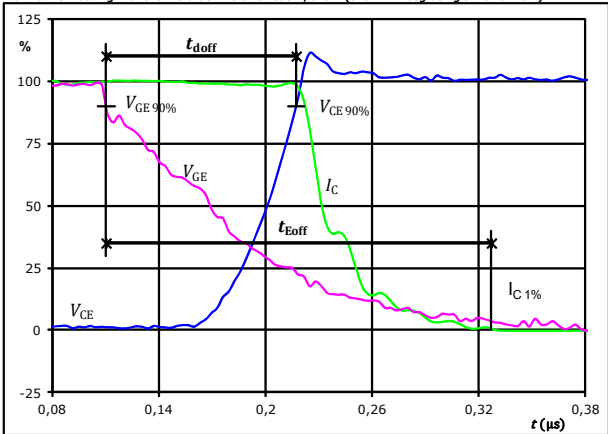

$V_{CE}(0\%) =$	-15	V
$V_{GE}(100\%) =$	15	V
$V_C(100\%) =$	350	V
$I_C(100\%) =$	30	A
$t_{doff} =$	0,106	μs
$t_{Eoff} =$	0,217	μs

figure 2. IGBT

Turn-on Switching Waveforms & definition of t_{don} , t_{Eon} (t_{Eon} = integrating time for Eon)

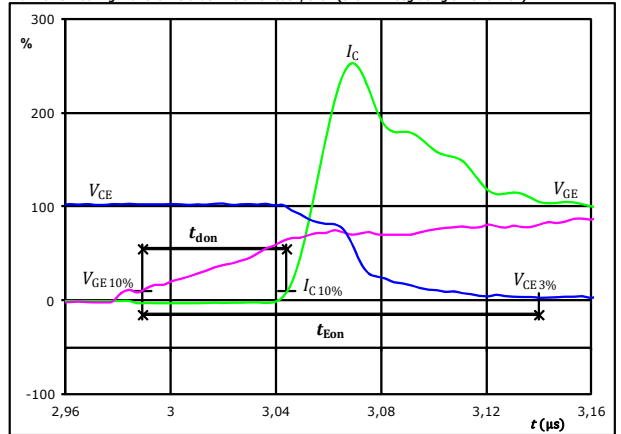

$V_{CE}(0\%) =$	-15	V
$V_{GE}(100\%) =$	15	V
$V_C(100\%) =$	350	V
$I_C(100\%) =$	30	A
$t_{don} =$	0,066	μs
$t_{Eon} =$	0,151	μs

figure 3. IGBT

Turn-off Switching Waveforms & definition of t_f

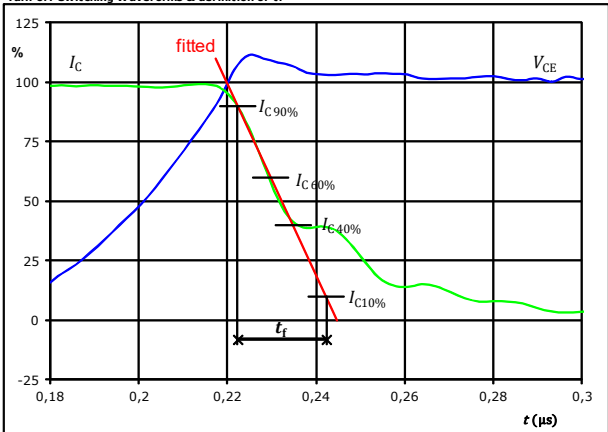

$V_C(100\%) =$	350	V
$I_C(100\%) =$	30	A
$t_f =$	0,033	μs

figure 4. IGBT

Turn-on Switching Waveforms & definition of t_r

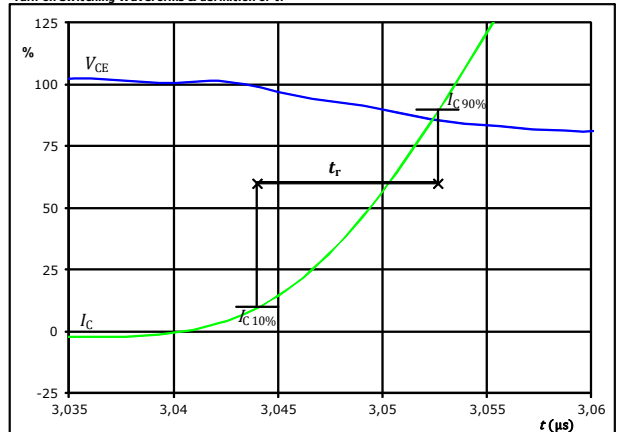

$V_C(100\%) =$	350	V
$I_C(100\%) =$	30	A
$t_r =$	0,009	μs



Vincotech

Input Boost Switching Characteristics

figure 5. IGBT

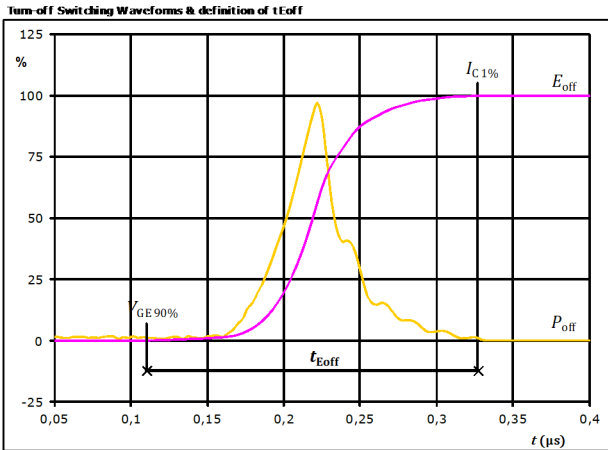

$P_{\text{off}}(100\%) = 10,59$ kW
 $E_{\text{off}}(100\%) = 0,48$ mJ
 $t_{\text{Eoff}} = 0,22$ µs

figure 6. IGBT

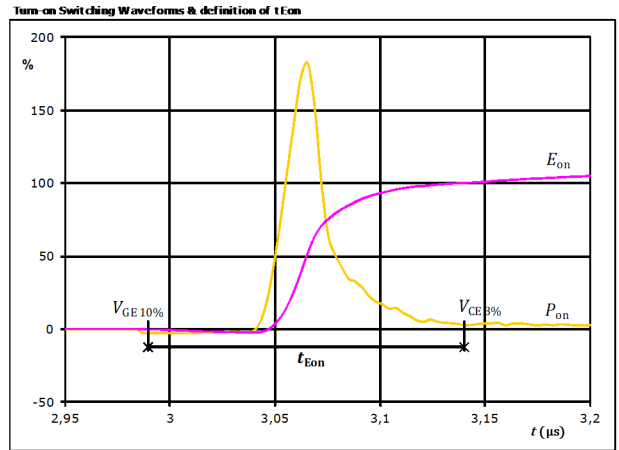

$P_{\text{on}}(100\%) = 10,59$ kW
 $E_{\text{on}}(100\%) = 0,54$ mJ
 $t_{\text{Eon}} = 0,15$ µs

figure 7. FWD

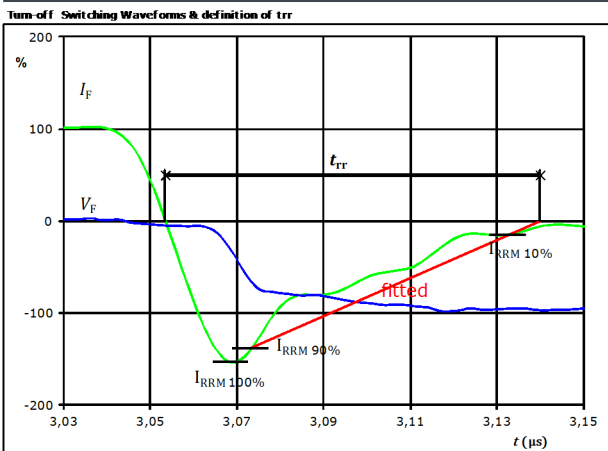

$V_{\text{F}}(100\%) = 350$ V
 $I_{\text{F}}(100\%) = 30$ A
 $I_{\text{RRM}}(100\%) = -44$ A
 $t_{\text{rr}} = 0,079$ µs



Vincotech

Input Boost Switching Characteristics

figure 8. FWD

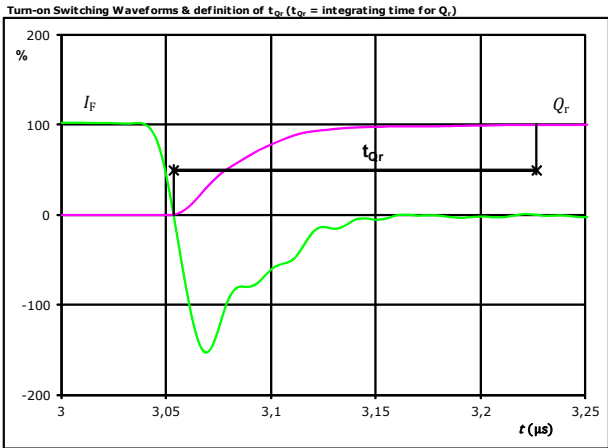

I_F (100%) = 30 A
 Q_r (100%) = 1,71 μC
 t_{Qr} = 0,17 μs

figure 9. FWD

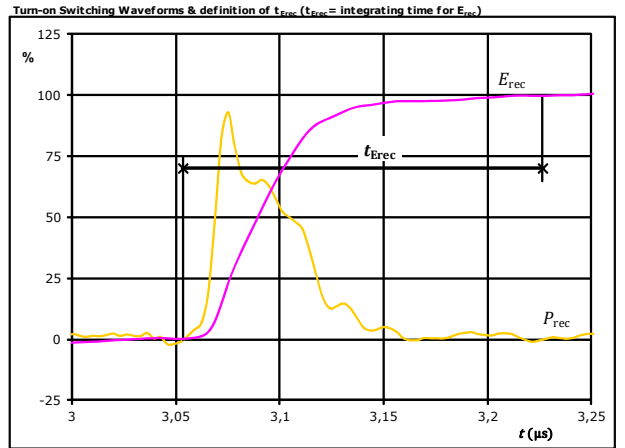

P_{rec} (100%) = 10,59 kW
 E_{rec} (100%) = 0,43 mJ
 t_{Erec} = 0,17 μs



Vincotech

Ordering Code & Marking								
Version			Ordering Code					
without thermal paste 12mm 2clips housing with Solder pins			10-FZ07BVA030S5-LD45E08					
with thermal paste 12mm 2 clips housing with Solder pins			10-FZ07BVA030S5-LD45E08-/3/					
without thermal paste 12mm housing without clips with Pressfit pins			10-PC07BVA030S5-LD45E06Y					
with thermal paste 12mm housing without clips with Pressfit pins			10-PC07BVA030S5-LD45E06Y-/3/					
NN-NNNNNNNNNNNN TTTTWW WWYY UL VIN LLLL SSSS			Text	Name	Date code	UL & VIN	Lot	Serial
				NN-NNNNNNNNNNNN-TTTTWW	WWYY	UL VIN	LLLL	SSSS
			Datamatrix	Type&Ver	Lot number	Serial	Date code	
			TTTTTWW	LLLL	SSSS	WWYY		

Pin table			
Pin	X	Y	Function
1	28,7	0	G13
2	25,9	0	S13
3	23,1	0	DC-2
4	17,6	0	DC+
5	12,1	0	S14
6	9,3	0	G14
7	2,8	0	G25
8	0	0	S25
9	0	5,05	DC-Boost
10	0	10,55	DC+Boost
11	0	16,15	DC+In
12	0	22,6	Boost+
13	9,3	22,6	G12
14	12,1	22,6	S12
15	17,6	22,6	DC+
16	23,1	22,6	DC-1
17	25,9	22,6	S11
18	28,7	22,6	G11
19	Not assembled		
20	33,6	14,55	G21
21	33,6	8,05	G22
22	Not assembled		
23	33,6	17,35	Ph1
24	30,8	14,55	S21
25	33,6	5,25	Ph2
26	30,8	8,05	S22
27	17,6	14,1	A20
28	11	8,5	Therm1
29	10	11,5	Therm2
30	Not assembled		

Tolerance of pinpositions: ±0.5mm at the end of pins
 Dimension of coordinate axis is only offset without tolerance

Outline

Technical drawing showing side and top views of the component. Dimensions include a width of 16.8mm, a height of 16.3 ± 0.5mm, and a pin diameter of φ 1 ± 0.05mm. The top view shows 30 pins numbered 1 through 30, with a coordinate system (X, Y) and a total width of 113mm. A note indicates the center of the press-fit pinhead and refers to the handling instruction for connection parameters.



Vincotech

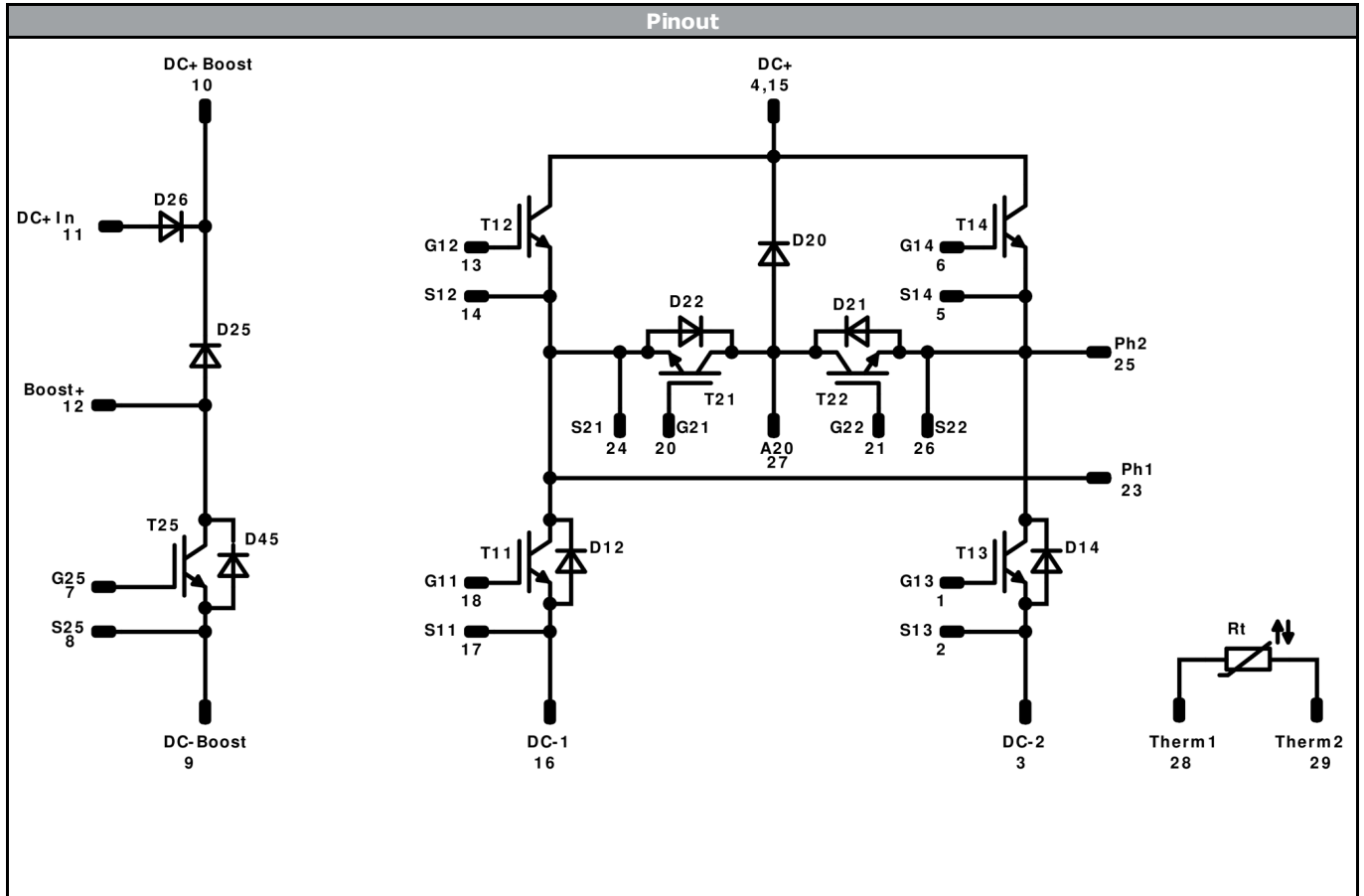

Identification					
ID	Component	Voltage	Current	Function	Comment
T11, T13, T12, T14	IGBT	650 V	30 A	Low Buck Switch / High Buck Switch	
D21, D22	FWD	650 V	20 A	Buck Diode	
T21, T22	IGBT	650 V	20 A	Boost Switch	
D20, D12, D14	FWD	650 V	20 A	High Boost Diode / Low Boost Diode	
T25	IGBT	650 V	30 A	Input Boost Switch	
D25	FWD	650 V	30 A	Input Boost Diode	
D45	FWD	650 V	10 A	Input Boost Sw. Protection Diode	
D26	Rectifier	1600 V	35 A	ByPass Diode	
Rt	NTC			Thermistor	



Vincotech

Packaging instruction			
Standard packaging quantity (SPQ) 135	>SPQ	Standard	<SPQ Sample

Handling instruction
Handling instructions for <i>flow 0</i> packages see vincotech.com website.

Package data
Package data for <i>flow 0</i> packages see vincotech.com website.

UL recognition and file number
This device is certified according to UL 1557 standard, UL file number E192116. For more information see vincotech.com website. 

Document No.:	Date:	Modification:	Pages
10-xx07BVA030S5-LD45E0xX-D2-14	18 Jun. 2019	Add new subtype with housing without clips and Pressfit pin	1,44

DISCLAIMER

The information, specifications, procedures, methods and recommendations herein (together "information") are presented by Vincotech to reader in good faith, are believed to be accurate and reliable, but may well be incomplete and/or not applicable to all conditions or situations that may exist or occur. Vincotech reserves the right to make any changes without further notice to any products to improve reliability, function or design. No representation, guarantee or warranty is made to reader as to the accuracy, reliability or completeness of said information or that the application or use of any of the same will avoid hazards, accidents, losses, damages or injury of any kind to persons or property or that the same will not infringe third parties rights or give desired results. It is reader's sole responsibility to test and determine the suitability of the information and the product for reader's intended use.

LIFE SUPPORT POLICY

Vincotech products are not authorised for use as critical components in life support devices or systems without the express written approval of Vincotech.

As used herein:

1. Life support devices or systems are devices or systems which, (a) are intended for surgical implant into the body, or (b) support or sustain life, or (c) whose failure to perform when properly used in accordance with instructions for use provided in labelling can be reasonably expected to result in significant injury to the user.
2. A critical component is any component of a life support device or system whose failure to perform can be reasonably expected to cause the failure of the life support device or system, or to affect its safety or effectiveness.

单击下面可查看定价，库存，交付和生命周期等信息

[>>Vincotech\(威科\)](#)