

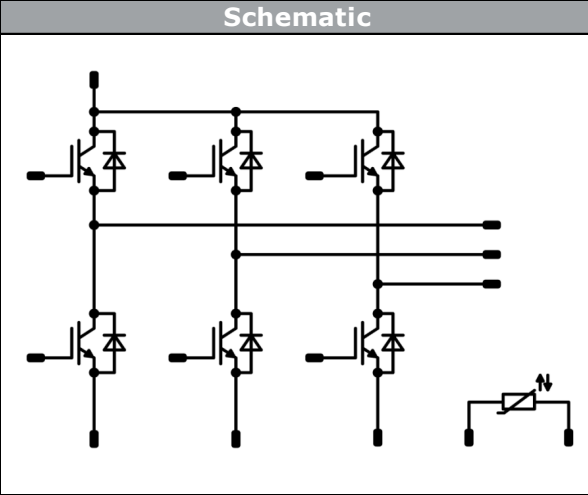

Vincotech

<i>flow</i> PACK 0B	600 V / 30 A
<div style="background-color: #eee; padding: 2px; margin-bottom: 5px;">Features</div> <ul style="list-style-type: none"> IGBT3 (600 V) technology Open emitter topology New ultra-compact housing Single-screw heat sink mounting 	<div style="background-color: #eee; padding: 2px; margin-bottom: 5px;">flow 0B housing</div> 
<div style="background-color: #eee; padding: 2px; margin-bottom: 5px;">Target applications</div> <ul style="list-style-type: none"> Embedded drives Industrial drives 	<div style="background-color: #eee; padding: 2px; margin-bottom: 5px;">Schematic</div> 
<div style="background-color: #eee; padding: 2px; margin-bottom: 5px;">Types</div> <ul style="list-style-type: none"> 10-0B066PA030SB-M996F09 10-ZB066PA030SB-M996F08 	

Maximum Ratings

$T_j = 25\text{ °C}$, unless otherwise specified

Parameter	Symbol	Condition	Value	Unit
Inverter Switch				
Collector-emitter voltage	V_{CES}		600	V
Collector current	I_C	$T_j = T_{jmax}$ $T_s = 80\text{ °C}$	34	A
Repetitive peak collector current	I_{CRM}	t_p limited by T_{jmax}	90	A
Turn off safe operating area		$T_j \leq 150\text{ °C}$, $V_{CE} \leq 1200\text{ V}$	90	A
Total power dissipation	P_{tot}	$T_j = T_{jmax}$ $T_s = 80\text{ °C}$	68	W
Gate-emitter voltage	V_{GES}		± 20	V
Short circuit ratings	t_{SC}	$T_j \leq 150\text{ °C}$	6	μs
	V_{CC}	$V_{GE} = 15\text{ V}$	360	V
Maximum junction temperature	T_{jmax}		175	°C



Maximum Ratings

$T_j = 25\text{ °C}$, unless otherwise specified

Parameter	Symbol	Condition	Value	Unit
Inverter Diode				
Peak repetitive reverse voltage	V_{RRM}		600	V
Continuous (direct) forward current	I_F	$T_j = T_{jmax}$ $T_s = 80\text{ °C}$	32	A
Total power dissipation	P_{tot}	$T_j = T_{jmax}$ $T_s = 80\text{ °C}$	53	W
Maximum junction temperature	T_{jmax}		175	°C

Module Properties

Thermal Properties

Storage temperature	T_{stg}		-40...+125	°C
Operation temperature under switching condition	T_{jop}		-40...($T_{jmax} - 25$)	°C

Isolation Properties

Isolation voltage	V_{isol}	DC Test Voltage $t_p = 2\text{ s}$	4000	V
Creepage distance			min. 12,7	mm
Clearance			min. 12,7	mm
Comparative Tracking Index	CTI		> 200	



Characteristic Values

Parameter	Symbol	Conditions					Value			Unit
		V_{GS} [V]	V_{GE} [V]	V_{DS} [V]	I_D [A]	T_j [°C]	Min	Typ	Max	

Inverter Switch

Static

Parameter	Symbol	Conditions	V_{GS} [V]	V_{GE} [V]	V_{DS} [V]	I_D [A]	T_j [°C]	Min	Typ	Max	Unit
Gate-emitter threshold voltage	$V_{GE(th)}$	$V_{GE} = V_{CE}$				0,00043	25	5	5,8	6,5	V
Collector-emitter saturation voltage	V_{CEsat}		15			30	25 125	1,1	1,51 1,71	1,9	V
Collector-emitter cut-off current	I_{CES}		0	600			25			1,6	μA
Gate-emitter leakage current	I_{GES}		20	0			25			300	nA
Internal gate resistance	r_g								none		Ω
Input capacitance	C_{ies}								1630		pF
Output capacitance	C_{oes}	$f = 1$ MHz	0	25		25			108		
Reverse transfer capacitance	C_{res}								50		
Gate charge	Q_g		15	400	30		25		167		nC

Thermal

Parameter	Symbol	Conditions	V_{GS} [V]	V_{GE} [V]	V_{DS} [V]	I_D [A]	T_j [°C]	Min	Typ	Max	Unit
Thermal resistance junction to sink	$R_{th(j-s)}$	$\lambda_{paste} = 1$ W/mK (P12)							1,41		K/W

Dynamic

Parameter	Symbol	Conditions	V_{GS} [V]	V_{GE} [V]	V_{DS} [V]	I_D [A]	T_j [°C]	Min	Typ	Max	Unit
Turn-on delay time	$t_{d(on)}$	$R_{goff} = 16$ Ω $R_{gon} = 16$ Ω	±15		300	30	25 150		106 104		ns
Rise time	t_r								14 20		
Turn-off delay time	$t_{d(off)}$								146 171		
Fall time	t_f								92 112		
Turn-on energy (per pulse)	E_{on}	$Q_{rFWD} = 1,3$ μC $Q_{rFWD} = 2,7$ μC					25 150		0,475 0,665		mWs
Turn-off energy (per pulse)	E_{off}					25 150		0,675 0,913			



Characteristic Values

Parameter	Symbol	Conditions					Value			Unit
		V_{GE} [V]	V_{CE} [V]	I_C [A]	T_j [°C]	Min	Typ	Max		

Inverter Diode

Static

Parameter	Symbol	V_{GS} [V]	V_{DS} [V]	I_D [A]	T_j [°C]	Min	Typ	Max	Unit
Forward voltage	V_F			30	25 125		1,65 1,62	1,95	V
Reverse leakage current	I_R		600		25			27	μA

Thermal

Parameter	Symbol	Conditions	Value	Unit
Thermal resistance junction to sink	$R_{th(j-s)}$	$\lambda_{paste} = 1$ W/mK (P12)	1,80	K/W

Dynamic

Parameter	Symbol	di/dt	I_C	I_F	T_j [°C]	Min	Typ	Max	Unit		
Peak recovery current	I_{RRM}	± 15	300	30	25		27		A		
Reverse recovery time	t_{rr}				150		34		146 253		ns
Recovered charge	Q_r				25		1,338		2,654		μC
Reverse recovered energy	E_{rec}				150		0,290 0,568				mWs
Peak rate of fall of recovery current	$(di_{rr}/dt)_{max}$				25		1752		815		A/μs

Thermistor

Parameter	Symbol	Conditions	T_j [°C]	Min	Typ	Max	Unit
Rated resistance	R		25		21,5		kΩ
Deviation of R_{100}	$\Delta_{R/R}$	$R_{100} = 1486 \Omega$	100	-4,5		+4,5	%
Power dissipation	P		25		210		mW
Power dissipation constant			25		3,5		mW/K
B-value	$B_{(25/50)}$		25		3884		K
B-value	$B_{(25/100)}$		25		3964		K
Vincotech NTC Reference						F	



Inverter Switch Characteristics

figure 1. IGBT

Typical output characteristics

$I_C = f(V_{CE})$

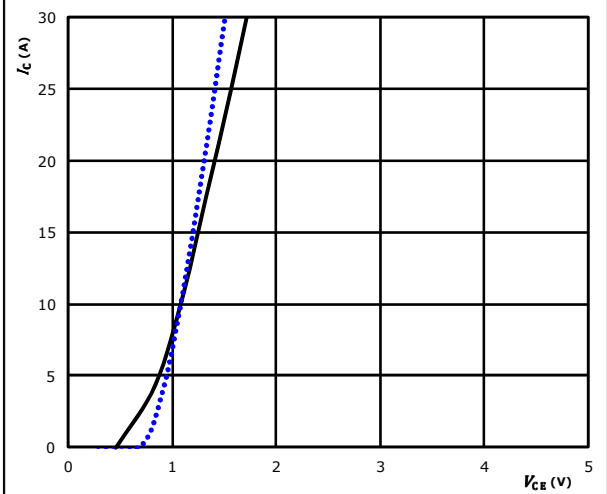

$t_p = 250 \mu s$ $T_j: 25 \text{ } ^\circ C$ (dotted blue line)
 $V_{GE} = 15 \text{ V}$ $125 \text{ } ^\circ C$ (solid black line)

figure 2. IGBT

Typical output characteristics

$I_C = f(V_{CE})$

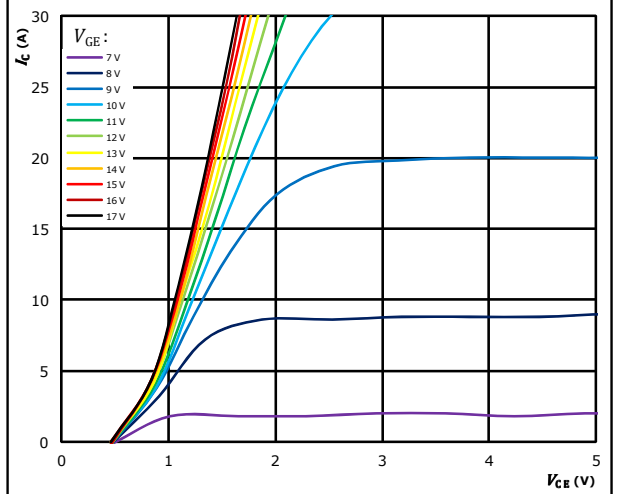

$t_p = 250 \mu s$
 $T_j = 125 \text{ } ^\circ C$
 V_{GE} from 7 V to 17 V in steps of 1 V

figure 3. IGBT

Typical transfer characteristics

$I_C = f(V_{GE})$

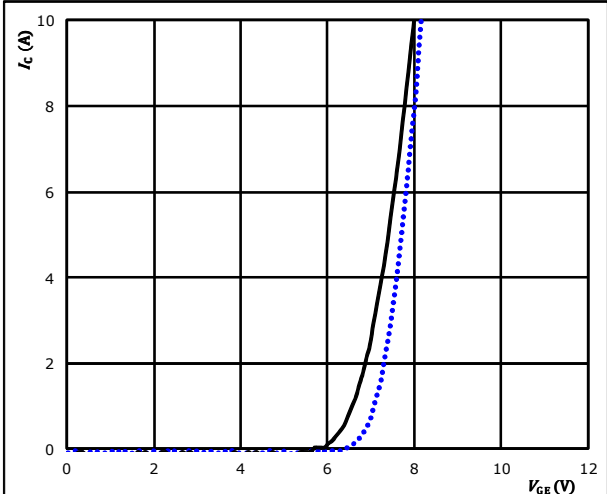

$t_p = 100 \mu s$ $T_j: 25 \text{ } ^\circ C$ (dotted blue line)
 $V_{CE} = 10 \text{ V}$ $125 \text{ } ^\circ C$ (solid black line)

figure 4. IGBT

Transient thermal impedance as function of pulse duration

$Z_{th(j-s)} = f(t_p)$

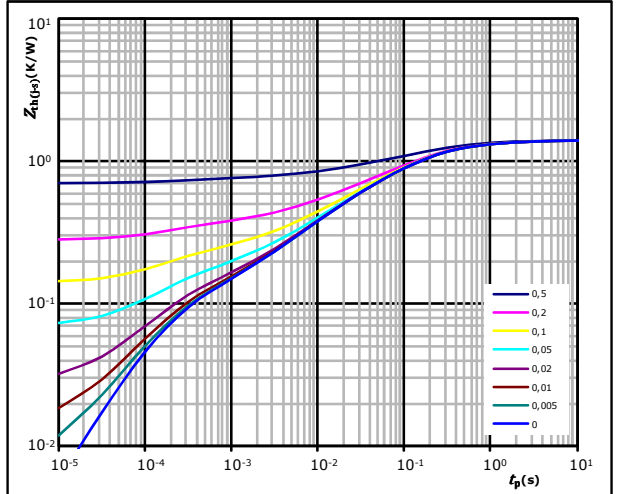

$D = t_p / T$
 $R_{th(j-s)} = 1,41 \text{ K/W}$
 IGBT thermal model values

R (K/W)	τ (s)
3,67E-02	9,82E+00
1,46E-01	1,04E+00
5,44E-01	1,78E-01
3,36E-01	4,31E-02
2,08E-01	8,55E-03
6,31E-02	9,19E-04
7,45E-02	1,51E-04



Inverter Switch Characteristics

figure 5. IGBT

Gate voltage vs gate charge

$$V_{GE} = f(Q_G)$$

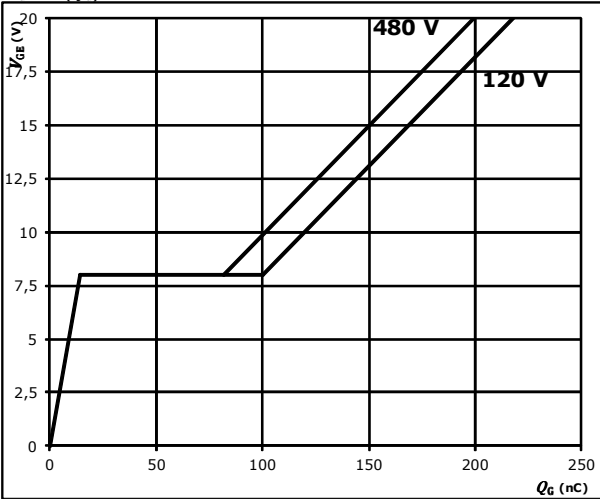

$I_C = 30$ A

figure 6. IGBT

Safe operating area

$$I_C = f(V_{CE})$$

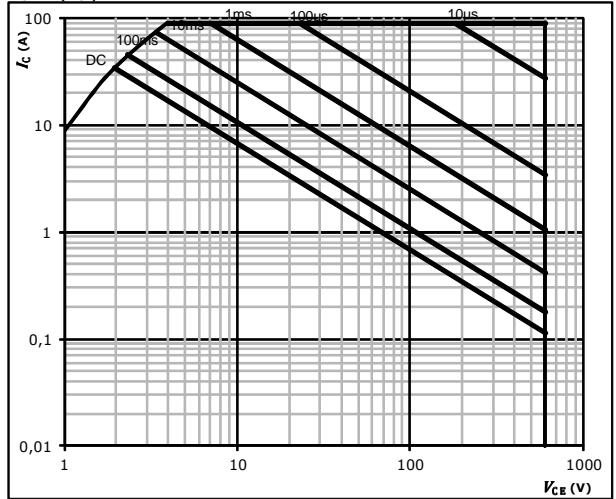

$D =$ single pulse
 $T_s = 80$ °C
 $V_{GE} = \pm 15$ V
 $T_j = T_{jmax}$ °C

figure 7. IGBT

Short circuit duration as a function of V_{GE}

$$t_{pSC} = f(V_{GE})$$

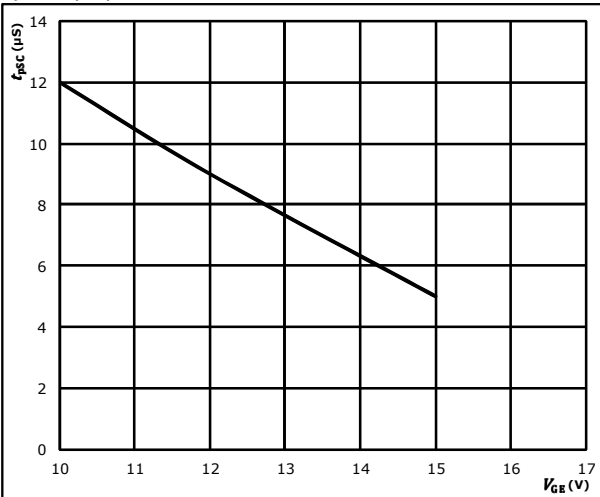

$V_{CE} = 400$ V
 $T_j \leq 150$ °C

figure 8. IGBT

Typical short circuit current as a function of V_{GE}

$$I_{SC} = f(V_{GE})$$

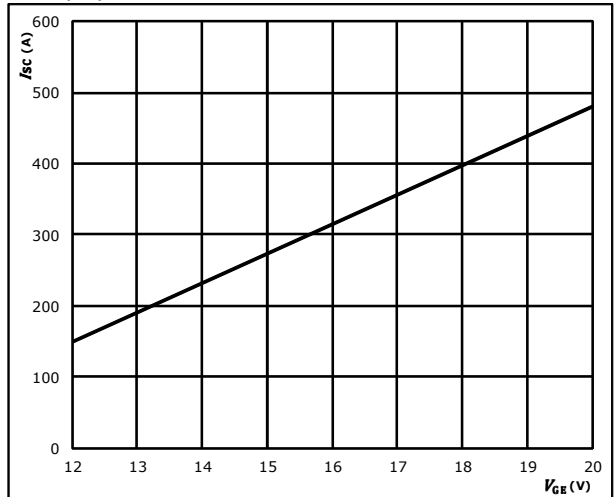

$V_{CE} \leq 400$ V
 $T_j \leq 150$ °C



Inverter Diode Characteristics

figure 1. FWD

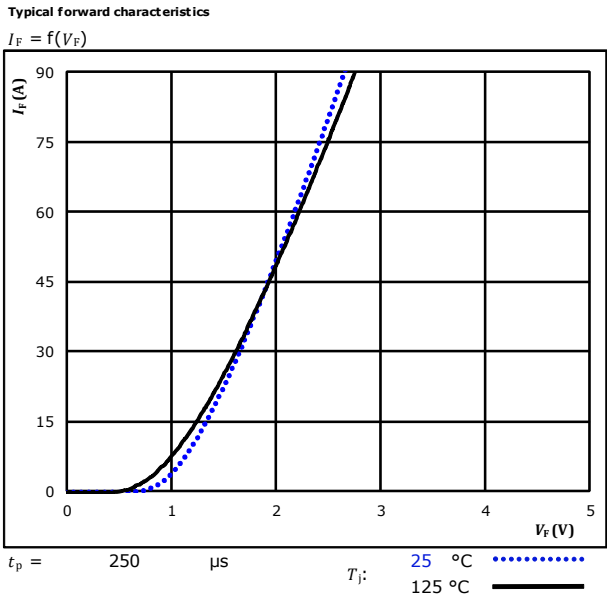
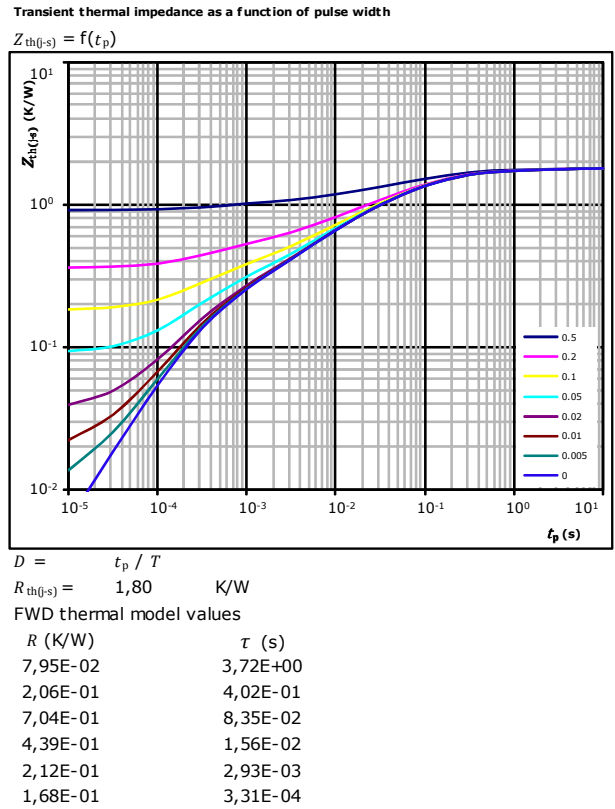
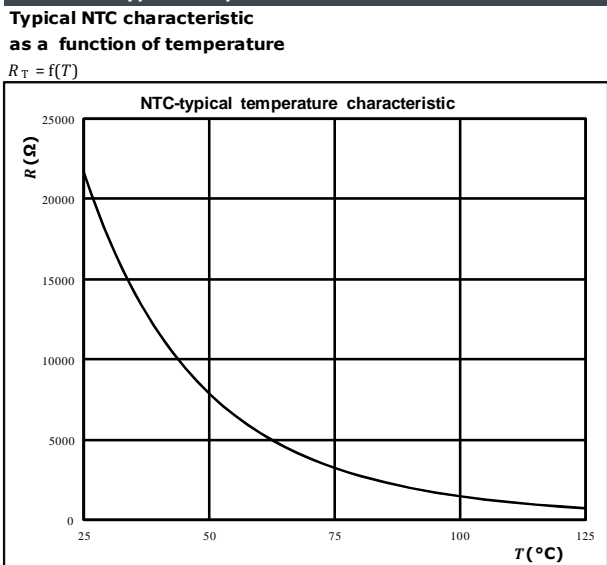

figure 2. FWD



Thermistor Characteristics

Thermistor typical temperature characteristic





Switching Characteristics

figure 1. IGBT

Typical switching energy losses as a function of collector current

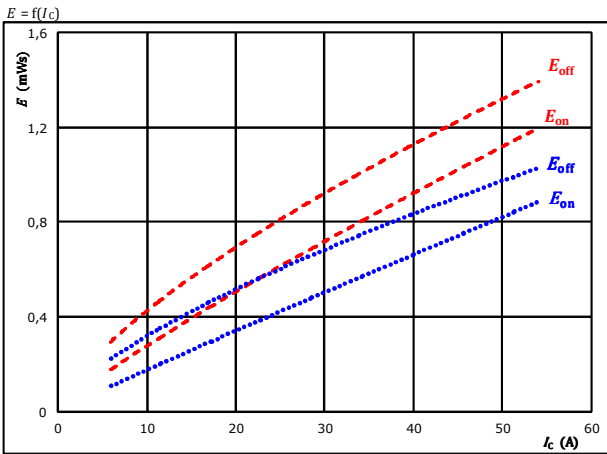

With an inductive load at
 $V_{CE} = 300$ V
 $V_{GE} = \pm 15$ V
 $R_{gon} = 16$ Ω
 $R_{goff} = 16$ Ω

T_j : 25 °C (blue dotted), 150 °C (red dashed)

figure 2. IGBT

Typical switching energy losses as a function of gate resistor

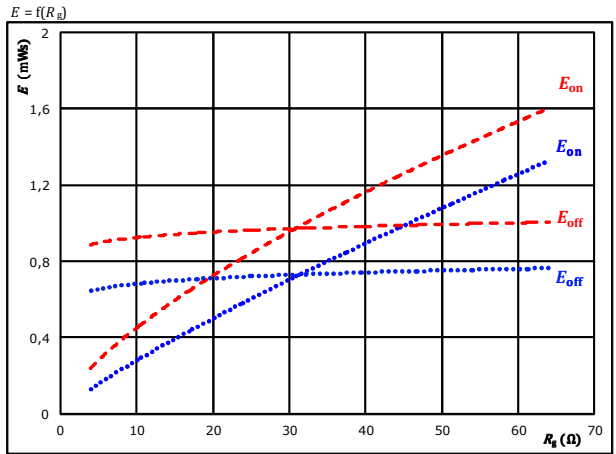

With an inductive load at
 $V_{CE} = 300$ V
 $V_{GE} = \pm 15$ V
 $I_C = 30$ A

T_j : 25 °C (blue dotted), 150 °C (red dashed)

figure 3. FWD

Typical reverse recovered energy loss as a function of collector current

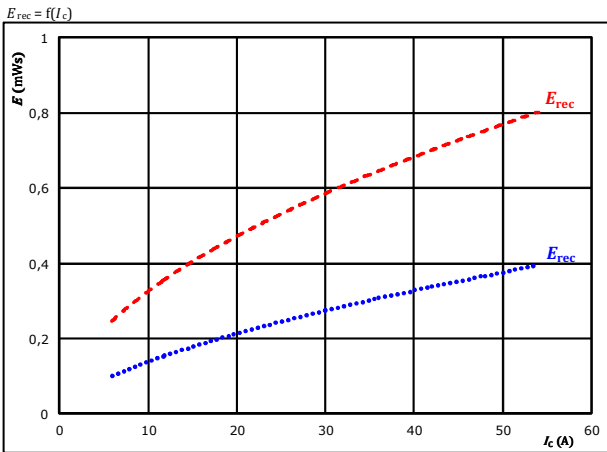

With an inductive load at
 $V_{CE} = 300$ V
 $V_{GE} = \pm 15$ V
 $R_{gon} = 16$ Ω

T_j : 25 °C (blue dotted), 150 °C (red dashed)

figure 4. FWD

Typical reverse recovered energy loss as a function of gate resistor

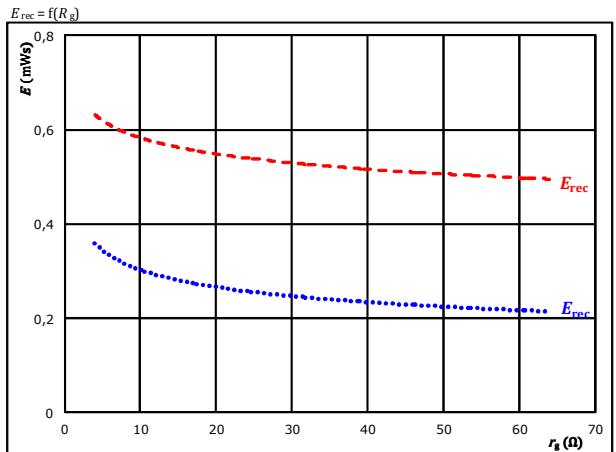

With an inductive load at
 $V_{CE} = 300$ V
 $V_{GE} = \pm 15$ V
 $I_C = 30$ A

T_j : 25 °C (blue dotted), 150 °C (red dashed)



Switching Characteristics

figure 5. IGBT

Typical switching times as a function of collector current

$$t = f(I_C)$$

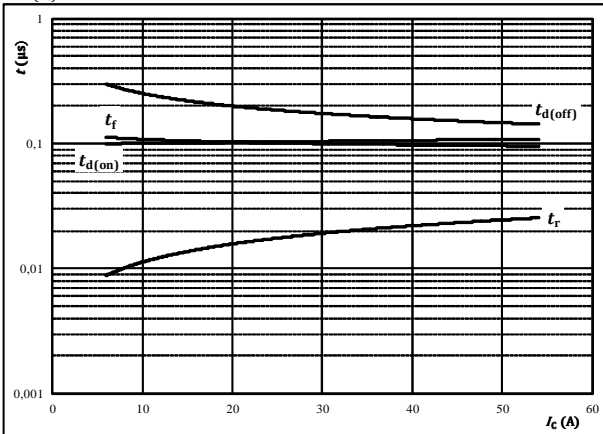

With an inductive load at

$T_j =$	150	°C
$V_{CE} =$	300	V
$V_{GE} =$	±15	V
$R_{gon} =$	16	Ω
$R_{goff} =$	16	Ω

figure 6. IGBT

Typical switching times as a function of gate resistor

$$t = f(R_g)$$

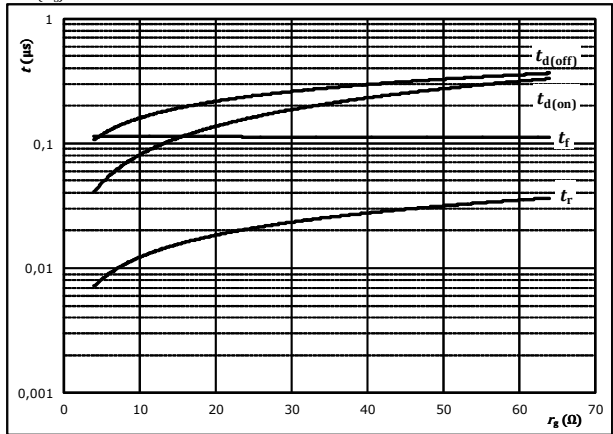

With an inductive load at

$T_j =$	150	°C
$V_{CE} =$	300	V
$V_{GE} =$	±15	V
$I_C =$	30	A

figure 7. FWD

Typical reverse recovery time as a function of collector current

$$t_{rr} = f(I_C)$$

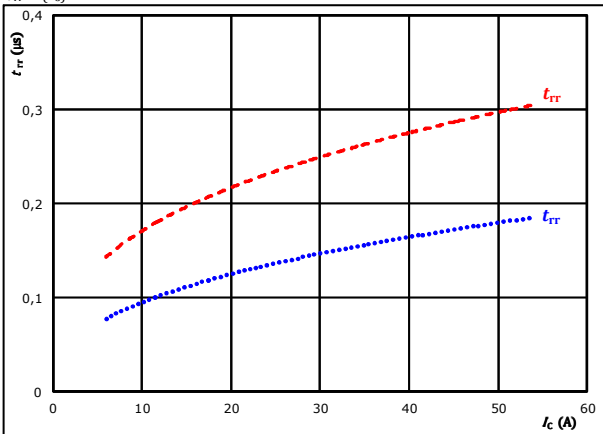

At	$V_{CE} =$	300	V	$T_j =$	25 °C
	$V_{GE} =$	±15	V		150 °C	-----
	$R_{gon} =$	16	Ω			

figure 8. FWD

Typical reverse recovery time as a function of IGBT turn on gate resistor

$$t_{rr} = f(R_{gon})$$

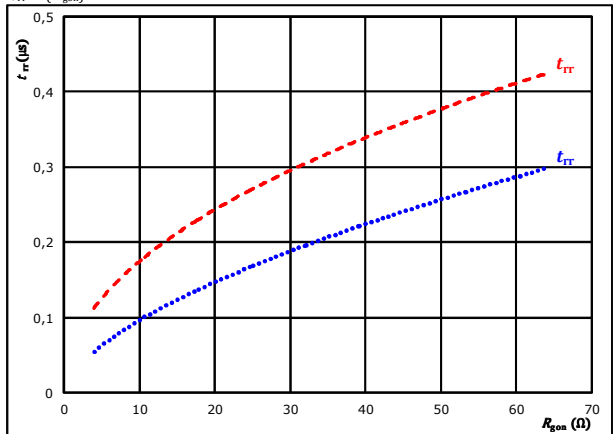

At	$V_{CE} =$	300	V	$T_j =$	25 °C
	$V_{GE} =$	±15	V		150 °C	-----
	$I_C =$	30	A			



Switching Characteristics

figure 9. FWD

Typical recovered charge as a function of collector current

$$Q_r = f(I_c)$$

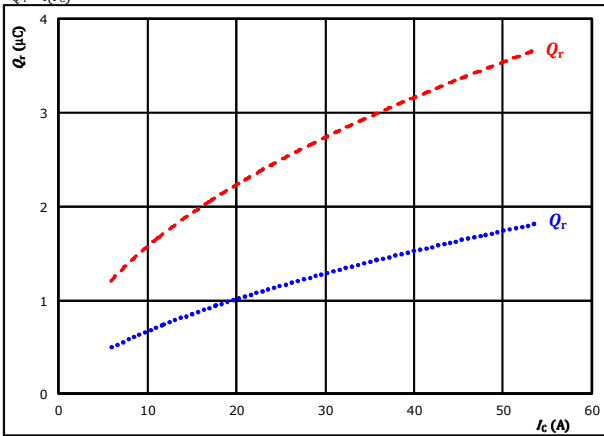

At $V_{CE} = 300$ V
 $V_{GE} = \pm 15$ V
 $R_{gpn} = 16$ Ω
 $T_j = 25$ °C (blue dotted line)
 $T_j = 150$ °C (red dashed line)

figure 10. FWD

Typical recovered charge as a function of IGBT turn on gate resistor

$$Q_r = f(R_{gpn})$$

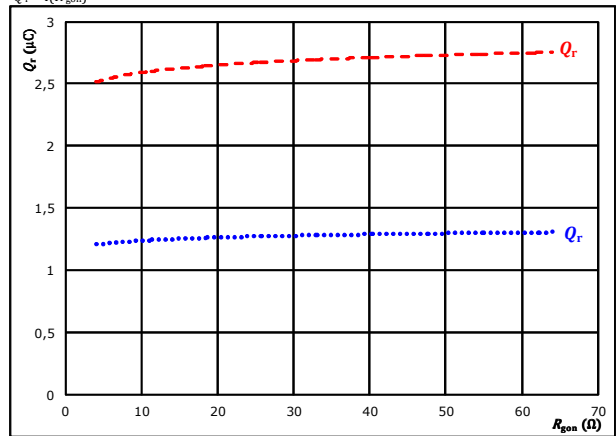

At $V_{CE} = 300$ V
 $V_{GE} = \pm 15$ V
 $I_c = 30$ A
 $T_j = 25$ °C (blue dotted line)
 $T_j = 150$ °C (red dashed line)

figure 11. FWD

Typical peak reverse recovery current as a function of collector current

$$I_{RM} = f(I_c)$$

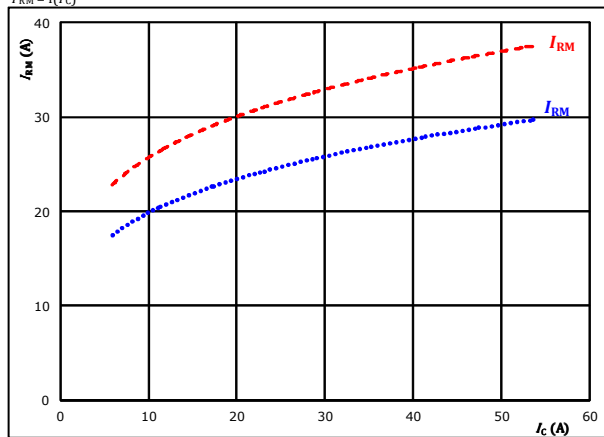

At $V_{CE} = 300$ V
 $V_{GE} = \pm 15$ V
 $R_{gpn} = 16$ Ω
 $T_j = 25$ °C (blue dotted line)
 $T_j = 150$ °C (red dashed line)

figure 12. FWD

Typical peak reverse recovery current as a function of IGBT turn on gate resistor

$$I_{RM} = f(R_{gpn})$$

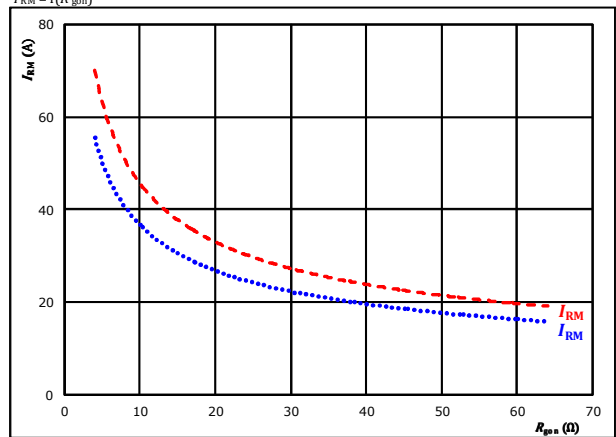

At $V_{CE} = 300$ V
 $V_{GE} = \pm 15$ V
 $I_c = 30$ A
 $T_j = 25$ °C (blue dotted line)
 $T_j = 150$ °C (red dashed line)



Switching Characteristics

figure 13. FWD

Typical rate of fall of forward and reverse recovery current as a function of collector current
 $di_f/dt, di_{rr}/dt = f(I_c)$

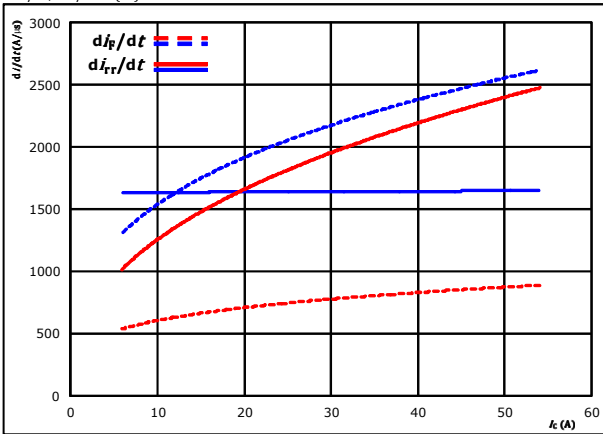

At $V_{CE} = 300$ V $T_j = 25$ °C
 $V_{GE} = \pm 15$ V $T_j = 150$ °C - - - - -
 $R_{gon} = 16$ Ω

figure 14. FWD

Typical rate of fall of forward and reverse recovery current as a function of IGBT turn on gate resistor
 $di_f/dt, di_{rr}/dt = f(R_{g})$

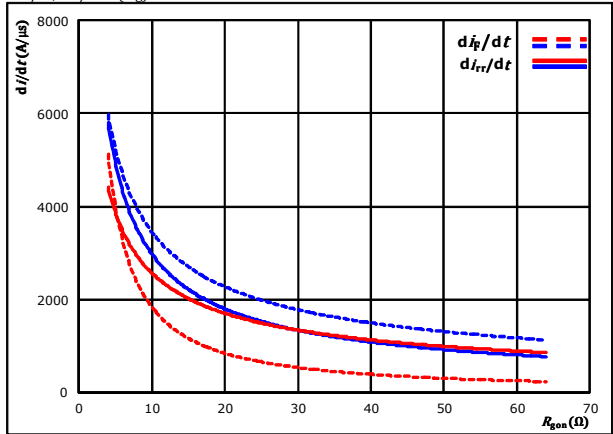

At $V_{CE} = 300$ V $T_j = 25$ °C
 $V_{GE} = \pm 15$ V $T_j = 150$ °C - - - - -
 $I_c = 30$ A

figure 15. IGBT

Reverse bias safe operating area
 $I_c = f(V_{ce})$

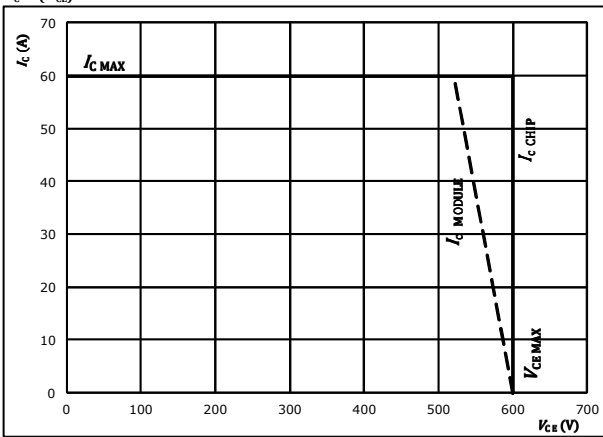

At $T_j = 175$ °C
 $R_{gon} = 16$ Ω
 $R_{goff} = 16$ Ω



Switching Characteristics

General conditions

T_j	=	150 °C
R_{gon}	=	16 Ω
R_{goff}	=	16 Ω

figure 1. IGBT

Turn-off Switching Waveforms & definition of t_{doff} , t_{Eoff} (t_{Eoff} = integrating time for E_{off})

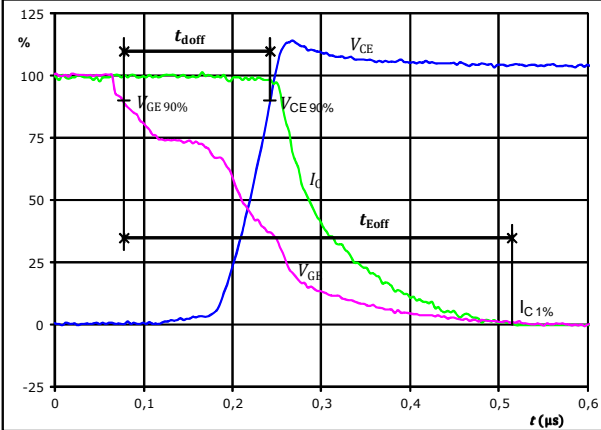

$V_{GE}(0\%)$	=	-15	V
$V_{GE}(100\%)$	=	15	V
$V_C(100\%)$	=	300	V
$I_C(100\%)$	=	30	A
t_{doff}	=	0,171	μs
t_{Eoff}	=	0,437	μs

figure 3. IGBT

Turn-off Switching Waveforms & definition of t_f

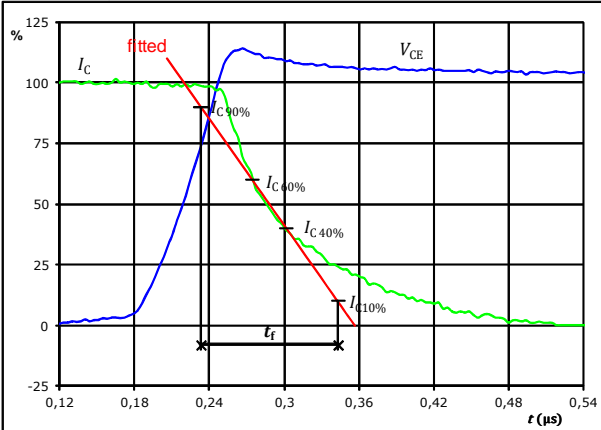

$V_C(100\%)$	=	300	V
$I_C(100\%)$	=	30	A
t_f	=	0,112	μs

figure 2. IGBT

Turn-on Switching Waveforms & definition of t_{don} , t_{Eon} (t_{Eon} = integrating time for E_{on})

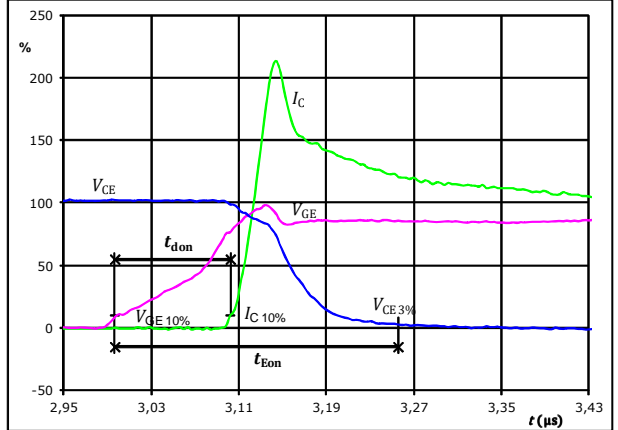

$V_{GE}(0\%)$	=	-15	V
$V_{GE}(100\%)$	=	15	V
$V_C(100\%)$	=	300	V
$I_C(100\%)$	=	30	A
t_{don}	=	0,104	μs
t_{Eon}	=	0,259	μs

figure 4. IGBT

Turn-on Switching Waveforms & definition of t_r

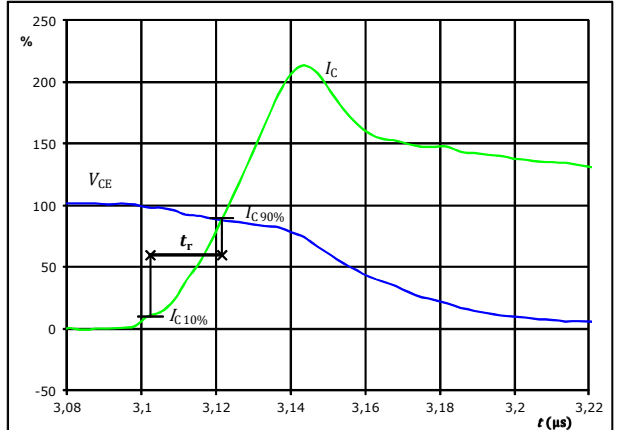

$V_C(100\%)$	=	300	V
$I_C(100\%)$	=	30	A
t_r	=	0,020	μs



Vincotech

Switching Characteristics

figure 5. IGBT

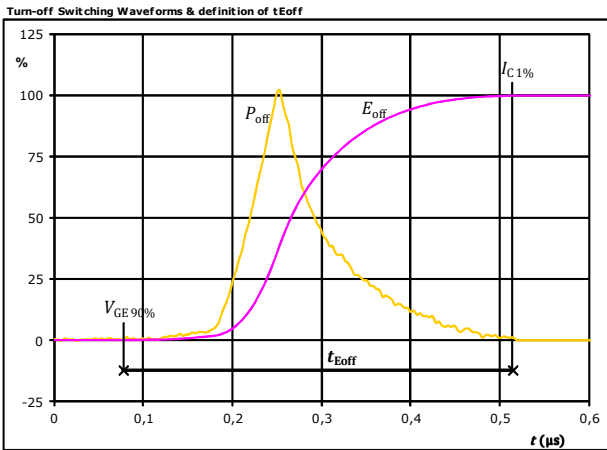

$P_{off}(100\%) = 9,01$ kW
 $E_{off}(100\%) = 0,91$ mJ
 $t_{Eoff} = 0,44$ μs

figure 6. IGBT

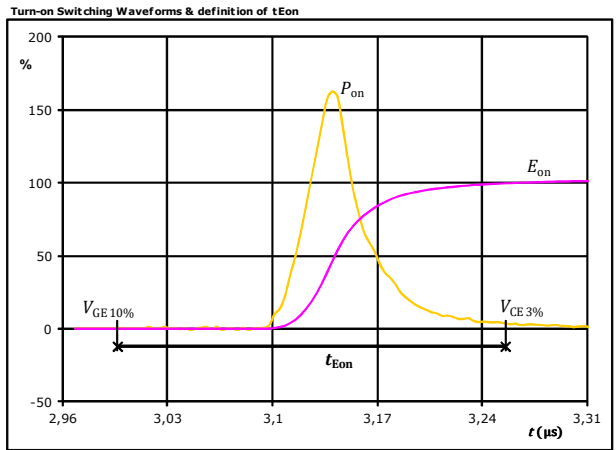

$P_{on}(100\%) = 9,01$ kW
 $E_{on}(100\%) = 0,67$ mJ
 $t_{Eon} = 0,26$ μs

figure 7. FWD

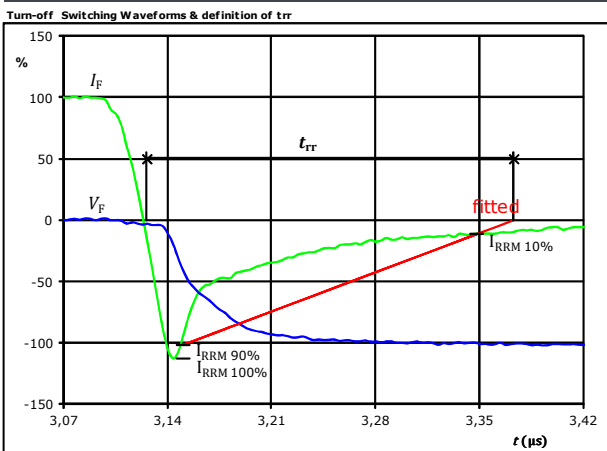

$V_F(100\%) = 300$ V
 $I_F(100\%) = 30$ A
 $I_{RRM}(100\%) = -34$ A
 $t_{rr} = 0,253$ μs



Vincotech

10-0B066PA030SB-M996F09
10-ZB066PA030SB-M996F08
 datasheet

Switching Characteristics

figure 8. FWD

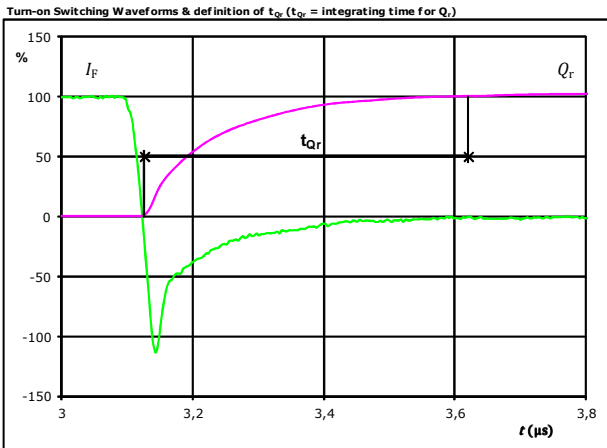

I_F (100%) =	30	A
Q_r (100%) =	2,65	μC
t_{Qr} =	0,49	μs

figure 9. FWD

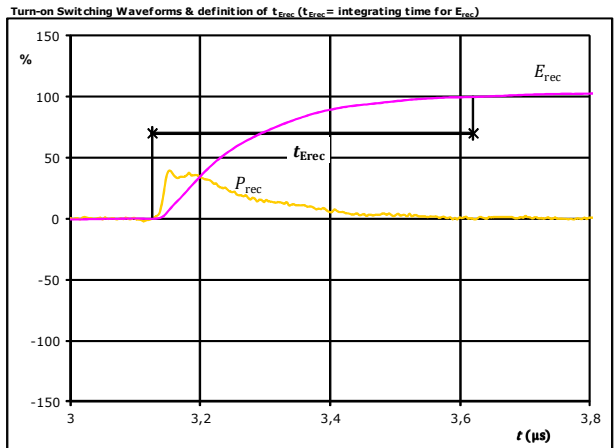

P_{rec} (100%) =	9,01	kW
E_{rec} (100%) =	0,57	mJ
t_{Erec} =	0,49	μs



Ordering Code & Marking						
Version				Ordering Code		
without thermal paste 17mm housing with solder pins				10-0B066PA030SB-M996F09		
without thermal paste 12mm housing with solder pins				10-ZB066PA030SB-M996F08		
						
Text	Name		Date code	UL & VIN	Lot	Serial
	NN-NNNNNNNNNNNNNN-TTTTTW		WWYY	UL VIN	LLLLL	SSSS
Datamatrix	Type&Ver	Lot number	Serial	Date code		
	TTTTTTTV	LLLLL	SSSS	WWYY		

Pin table [mm]			
Pin	X	Y	Function
1	27,8	0	G6
2	24,9	0	E6
3	19,1	0	G5
4	16,2	0	E5
5	11,6	0	NTC2
6	7,6	0	NTC1
7	2,9	0	E4
8	0	0	G4
9	0	13,7	U
10	2,9	13,7	G1
11	8,8	13,7	DC+
12	14,6	13,7	V
13	17,5	13,7	G2
14	24,9	13,7	G3
15	27,8	13,7	W

17 mm housing

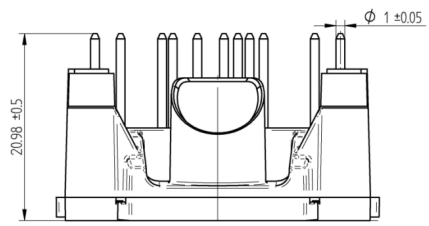

12 mm housing

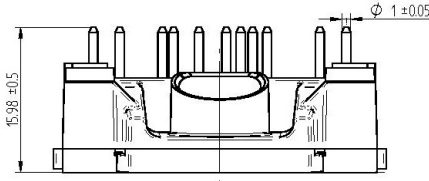

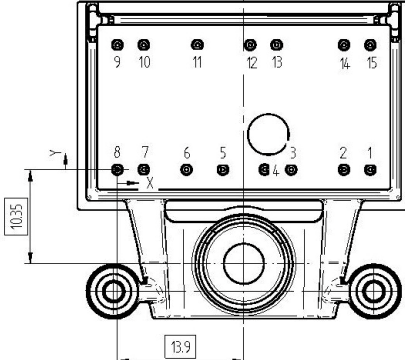

Tolerance of pinpositions: ±0,5mm at the end of pins.
 Dimension of coordinate axis is only offset without tolerance
 PCB cutouts and holes see in handling instruction document



Vincotech

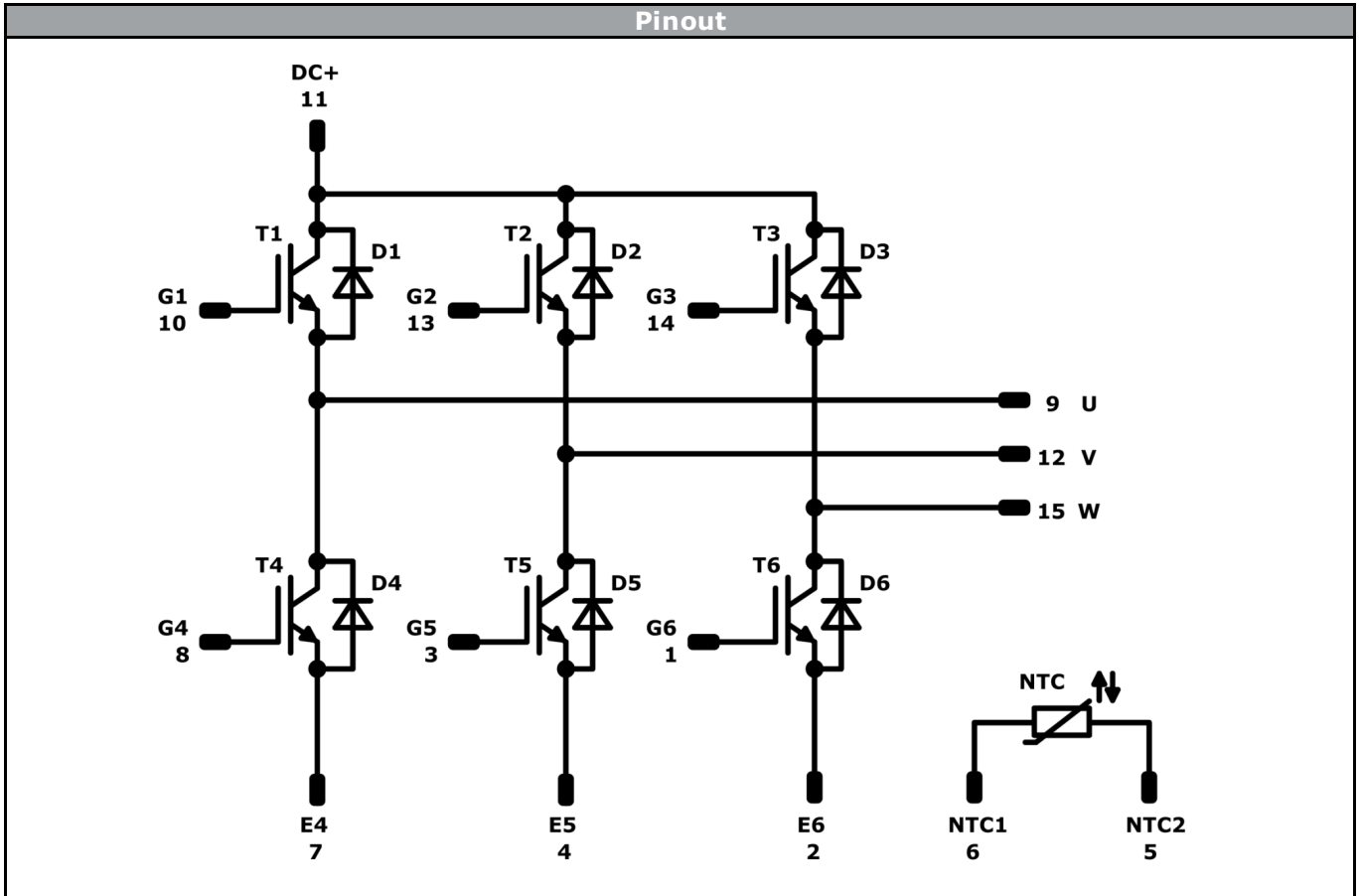

Identification					
ID	Component	Voltage	Current	Function	Comment
T1-T6	IGBT	600 V	30 A	Inverter Switch	
D1-D6	FWD	600 V	30 A	Inverter Diode	
NTC	NTC			Thermistor	



Vincotech

Packaging instruction			
Standard packaging quantity (SPQ) 160	>SPQ	Standard	<SPQ Sample

Handling instruction
Handling instructions for <i>flow0</i> B packages see vincotech.com website.

Package data
Package data for <i>flow0</i> B packages see vincotech.com website.

UL recognition and file number
This device is certified according to UL 1557 standard, UL file number E192116. For more information see vincotech.com website. 

Document No.:	Date:	Modification:	Pages
10-xB066PA030SB-M996F0x-D4-14	10 Jan. 2018	Added 12 mm housing version	1 , 15

DISCLAIMER

The information, specifications, procedures, methods and recommendations herein (together "information") are presented by Vincotech to reader in good faith, are believed to be accurate and reliable, but may well be incomplete and/or not applicable to all conditions or situations that may exist or occur. Vincotech reserves the right to make any changes without further notice to any products to improve reliability, function or design. No representation, guarantee or warranty is made to reader as to the accuracy, reliability or completeness of said information or that the application or use of any of the same will avoid hazards, accidents, losses, damages or injury of any kind to persons or property or that the same will not infringe third parties rights or give desired results. It is reader's sole responsibility to test and determine the suitability of the information and the product for reader's intended use.

LIFE SUPPORT POLICY

Vincotech products are not authorised for use as critical components in life support devices or systems without the express written approval of Vincotech.

As used herein:

1. Life support devices or systems are devices or systems which, (a) are intended for surgical implant into the body, or (b) support or sustain life, or (c) whose failure to perform when properly used in accordance with instructions for use provided in labelling can be reasonably expected to result in significant injury to the user.
2. A critical component is any component of a life support device or system whose failure to perform can be reasonably expected to cause the failure of the life support device or system, or to affect its safety or effectiveness.

单击下面可查看定价，库存，交付和生命周期等信息

[>>Vincotech\(威科\)](#)