

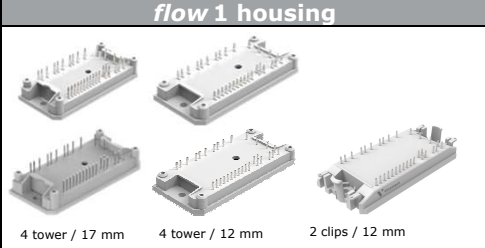
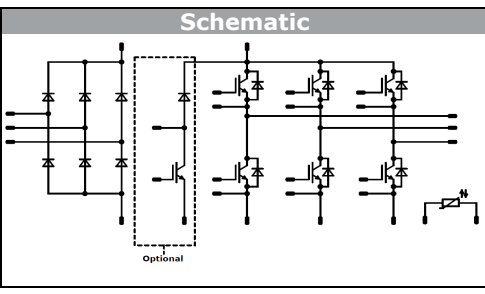

<i>flow</i> PIM 1	600 V / 30 A
<div style="border: 1px solid black; padding: 5px; margin-bottom: 10px;"> <p style="text-align: center; background-color: #ccc; margin: 0;">Features</p> <ul style="list-style-type: none"> Three-phase rectifier, optional BRC, Inverter, NTC Very compact housing, easy to route Trenchstop™ IGBT3 for low saturation losses </div> <div style="border: 1px solid black; padding: 5px; margin-bottom: 10px;"> <p style="text-align: center; background-color: #ccc; margin: 0;">Target Applications</p> <ul style="list-style-type: none"> Industrial drives Embedded drives </div> <div style="border: 1px solid black; padding: 5px;"> <p style="text-align: center; background-color: #ccc; margin: 0;">Types</p> <ul style="list-style-type: none"> V23990-P585-A20-PM V23990-P585-A20Y-PM V23990-P585-A208-PM V23990-P585-A208Y-PM V23990-P585-C20-PM V23990-P585-C20Y-PM 10-TY06PMA030SA-P585A206 </div>	<div style="border: 1px solid black; padding: 5px; margin-bottom: 10px;"> <p style="text-align: center; background-color: #ccc; margin: 0;">flow 1 housing</p>  <p style="font-size: small; text-align: center;">4 tower / 17 mm 4 tower / 12 mm 2 clips / 12 mm</p> </div> <div style="border: 1px solid black; padding: 5px;"> <p style="text-align: center; background-color: #ccc; margin: 0;">Schematic</p>  <p style="font-size: x-small; text-align: center;">Optional</p> </div>

Maximum Ratings

$T_j = 25\text{ °C}$, unless otherwise specified

Parameter	Symbol	Condition	Value	Unit
Rectifier Diode				
Repetitive peak reverse voltage	V_{RRM}		1600	V
DC forward current	I_{FAV}	$T_j = T_{jmax}$ $T_s = 80\text{ °C}$	33	A
Surge (non-repetitive) forward current	I_{FSM}	$t_p = 10\text{ ms}$	250	A
I2t-value	I^2t	50 Hz half sine wave	310	A ² s
Power dissipation	P_{tot}	$T_j = T_{jmax}$ $T_s = 80\text{ °C}$	37	W
Maximum Junction Temperature	T_{jmax}		150	°C
Inverter Switch				
Collector-emitter breakdown voltage	V_{CE}		600	V
DC collector current	I_C		30	A
Repetitive peak collector current	I_{CRM}	t_p limited by T_{jmax}	90	A
Turn off safe operating area		$V_{CE} \leq 1200V, T_j \leq T_{op\ max}$	90	A
Power dissipation	P_{tot}	$T_j = T_{jmax}$ $T_s = 80\text{ °C}$	55	W
Gate-emitter peak voltage	V_{GE}		±20	V
Short circuit ratings	t_{SC} V_{CC}	$T_j \leq 150\text{ °C}$ $V_{GE} = 15\text{ V}$	6 360	µs V
Maximum Junction Temperature	T_{jmax}		175	°C



Vincotech

Maximum Ratings

 $T_j = 25\text{ °C}$, unless otherwise specified

Parameter	Symbol	Condition	Value	Unit
Inverter Diode				
Peak Repetitive Reverse Voltage	V_{RRM}		600	V
DC forward current	I_F	$T_j = T_{jmax}$ $T_s = 80\text{ °C}$	25	A
Repetitive peak forward current	I_{FRM}	t_p limited by T_{jmax}	60	A
Power dissipation	P_{tot}	$T_j = T_{jmax}$ $T_s = 80\text{ °C}$	46	W
Maximum Junction Temperature	T_{jmax}		175	°C

Brake Switch

Collector-emitter breakdown voltage	V_{CE}		600	V
DC collector current	I_C		20	A
Repetitive peak collector current	I_{CRM}	t_p limited by T_{jmax}	60	A
Turn off safe operating area		$V_{CE} \leq 1200V, T_j \leq T_{op\ max}$	65	A
Power dissipation	P_{tot}	$T_j = T_{jmax}$ $T_s = 80\text{ °C}$	45	W
Gate-emitter peak voltage	V_{GE}		± 20	V
Short circuit ratings	t_{SC} V_{CC}	$T_j \leq 150\text{ °C}$ $V_{GE} = 15\text{ V}$	6 360	μs V
Maximum Junction Temperature	T_{jmax}		175	°C

Brake Diode

Peak Repetitive Reverse Voltage	V_{RRM}		600	V
DC forward current	I_F	$T_j = T_{jmax}$ $T_s = 80\text{ °C}$	14	A
Repetitive peak forward current	I_{FRM}	t_p limited by T_{jmax}	40	A
Power dissipation	P_{tot}	$T_j = T_{jmax}$ $T_s = 80\text{ °C}$	20	W
Maximum Junction Temperature	T_{jmax}		175	°C

Thermal Properties

Storage temperature	T_{stg}		-40...+125	°C
Operation temperature under switching condition	T_{op}		-40...+($T_{jmax} - 25$)	°C

Isolation Properties

Isolation voltage	V_{is}	$t = 2\text{ s}$ DC Test Voltage	4000	V
Creepage distance			min 12,7	mm
Clearance		12 mm housing solder pin / press-fit pin	7,91 / 7,96	mm
		17 mm housing	min 12,7	mm
Comparative Tracking Index	CTI		>200	



Characteristic Values

Parameter	Symbol	Conditions					Value			Unit			
		V_{GE} [V]	V_{GS} [V]	V_r [V]	V_{CE} [V]	V_{DS} [V]	I_C [A]	I_F [A]	I_D [A]		T_j [°C]	Min	Typ
Rectifier Diode													
Forward voltage	V_F					30	25 125			0,8	1,16 1,13	1,6	V
Threshold voltage (for power loss calc. only)	V_{to}					30	25 125				0,90 0,78		V
Slope resistance (for power loss calc. only)	r_t					30	25 125				8 11		mΩ
Reverse current	I_r			1500				150				2	mA
Thermal resistance junction to sink	$R_{th(j-s)}$	$\lambda_{paste} = 0,8$ W/mK (P12)									1,89		K/W
Thermal resistance junction to sink	$R_{th(j-s)}$	$\lambda_{paste} = 3,4$ W/mK (PSX)									1,17		K/W
Inverter Switch													
Gate emitter threshold voltage	$V_{GE(th)}$	$V_{CE} = V_{GE}$				0,00043	25			4,1	4,9	5,7	V
Collector-emitter saturation voltage	V_{CESat}		15			30	25 125			1,1	1,70 1,77	1,9	V
Collector-emitter cut-off current incl. Diode	I_{CES}		0	600			25 125				0,04 1		mA
Gate-emitter leakage current	I_{GES}		20	0			25					300	nA
Integrated Gate resistor	R_{gint}										none		Ω
Turn-on delay time	$t_{d(on)}$						25 125				93 93,5		ns
Rise time	t_r						25 125				15 17,5		
Turn-off delay time	$t_{d(off)}$						25 125				141 159,5		
Fall time	t_f						25 125				67,1 86,7		
Turn-on energy loss	E_{on}						25 125				0,42 0,63		mWs
Turn-off energy loss	E_{off}						25 125				0,59 0,80		
Input capacitance	C_{ies}										1630		pF
Output capacitance	C_{oss}	$f = 1$ MHz	0	25			25				108		
Reverse transfer capacitance	C_{rss}										50		
Gate charge	Q_G		15	480	30	25					167		nC
Thermal resistance junction to sink	$R_{th(j-s)}$	$\lambda_{paste} = 0,8$ W/mK (P12)									1,6		K/W
Thermal resistance junction to sink	$R_{th(j-s)}$	$\lambda_{paste} = 3,4$ W/mK (PSX)									1,37		K/W



Characteristic Values

Parameter	Symbol	Conditions					Value			Unit				
		V_{GE} [V]	V_{GS} [V]	V_r [V]	V_{CE} [V]	V_{DS} [V]	I_C [A]	I_F [A]	I_D [A]		T_j [°C]	Min	Typ	Max
Inverter Diode														
Diode forward voltage	V_F					30	25 125				1,25	1,75 1,70	1,95	V
Peak reverse recovery current	I_{RRM}						25 125					29 34		A
Reverse recovery time	t_{rr}						25 125					35 183		ns
Reverse recovered charge	Q_{rr}	$R_{gon} = 16 \Omega$	-15	300		30	25 125					1,20 2,16		μ C
Peak rate of fall of recovery current	$(di_{rr}/dt)_{max}$						25 125					2200 1576		A/ μ s
Reverse recovered energy	E_{rec}						25 125					0,23 0,45		mWs
Thermal resistance junction to sink	$R_{th(j-s)}$	$\lambda_{paste} = 0,8$ W/mK (P12)										2,07		K/W
Thermal resistance junction to sink	$R_{th(j-s)}$	$\lambda_{paste} = 3,4$ W/mK (PSX)										1,81		K/W
Brake Switch														
Gate emitter threshold voltage	$V_{GE(th)}$	$V_{CE} = V_{CE}$				0,00029	25				5	5,8	6,5	V
Collector-emitter saturation voltage	V_{CEsat}		15			20	25 125			1,1	1,55 1,75	1,9		V
Collector-emitter cut-off incl diode	I_{CES}		0	600			25 125					0,04 1		mA
Gate-emitter leakage current	I_{GES}		20	0			25						300	nA
Integrated Gate resistor	R_{gint}										none			Ω
Turn-on delay time	$t_{d(on)}$						25 125					126 128		ns
Rise time	t_r						25 125					18 21		
Turn-off delay time	$t_{d(off)}$	$R_{goff} = 32 \Omega$ $R_{gon} = 32 \Omega$	± 15	300		20	25 125					161 179		
Fall time	t_f						25 125					105 114		
Turn-on energy loss	E_{on}						25 125					0,44 0,59		mWs
Turn-off energy loss	E_{off}						25 125					0,49 0,63		
Input capacitance	C_{ies}											1100		pF
Output capacitance	C_{oss}	$f = 1$ MHz	0	25		20	25					71		
Reverse transfer capacitance	C_{rss}											32		
Gate charge	Q_G		15	480		20	25					120		nC
Thermal resistance junction to sink	$R_{th(j-s)}$	$\lambda_{paste} = 0,8$ W/mK (P12)										2,12		K/W
Thermal resistance junction to sink	$R_{th(j-s)}$	$\lambda_{paste} = 3,4$ W/mK (PSX)										1,83		K/W



Characteristic Values

Parameter	Symbol	Conditions					Value			Unit			
		V_{GE} [V]	V_{GS} [V]	V_r [V]	V_{CE} [V]	V_{DS} [V]	I_C [A]	I_F [A]	I_D [A]		T_j [°C]	Min	Typ
Brake Diode													
Diode forward voltage	V_F					20	25	125		1,25	1,43	1,95	V
Reverse leakage current	I_r			600			25					27	μA
Peak reverse recovery current	I_{RRM}						25				10		A
Reverse recovery time	t_{rr}	$R_{gon} = 32 \Omega$	-15	300	20		25				11		ns
Reverse recovered charge	Q_{rr}						$R_{gon} = 32 \Omega$	25			125		
Peak rate of fall of recovery current	$(di_{rr}/dt)_{max}$						25				1247		A/μs
Reverse recovery energy	E_{rec}						125				443		mWs
Thermal resistance junction to sink	$R_{th(j-s)}$										0,051		K/W
Thermal resistance junction to sink	$R_{th(j-s)}$										0,100		K/W
Thermistor													
Rated resistance	R						25				22000		Ω
Deviation of R_{100}	$\Delta_{R/R}$						100		-5			5	%
Power dissipation	P						25				200		mW
Power dissipation constant							25				2		mW/K
B-value	$B_{(25/50)}$	Tol. ±3%					25				3950		K
B-value	$B_{(25/100)}$						25				3996		K
Vincotech NTC Reference							25					B	



Output Inverter

figure 1. IGBT

Typical output characteristics

$I_C = f(V_{CE})$

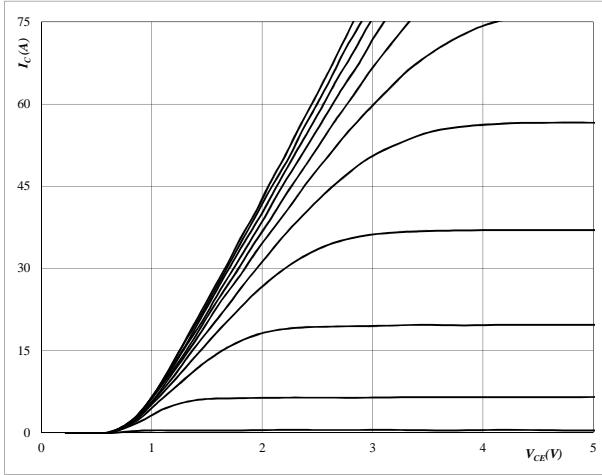

At
 $t_p = 250 \mu s$
 $T_j = 25 \text{ } ^\circ C$
 V_{GE} from 7 V to 17 V in steps of 1 V

figure 2. IGBT

Typical output characteristics

$I_C = f(V_{CE})$

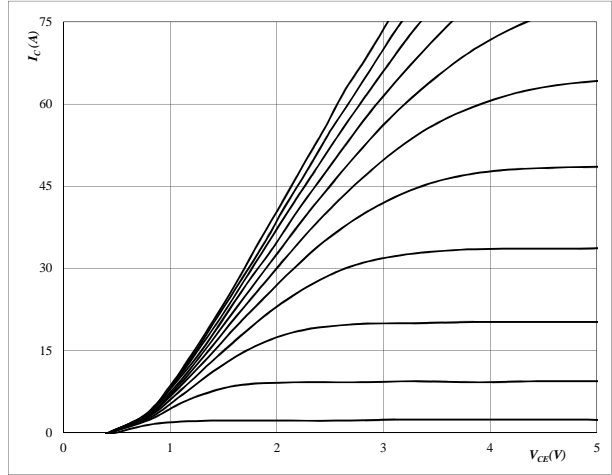

At
 $t_p = 250 \mu s$
 $T_j = 125 \text{ } ^\circ C$
 V_{GE} from 7 V to 17 V in steps of 1 V

figure 3. IGBT

Typical transfer characteristics

$I_C = f(V_{GE})$

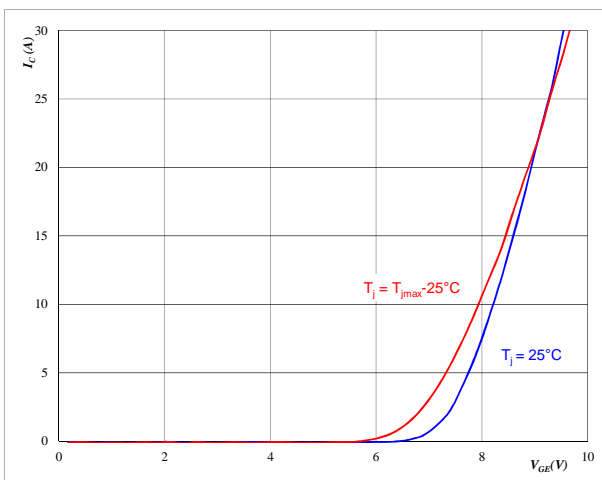

At
 $t_p = 250 \mu s$
 $V_{CE} = 10 V$

figure 4. FWD

Typical diode forward current as a function of forward voltage

$I_F = f(V_F)$

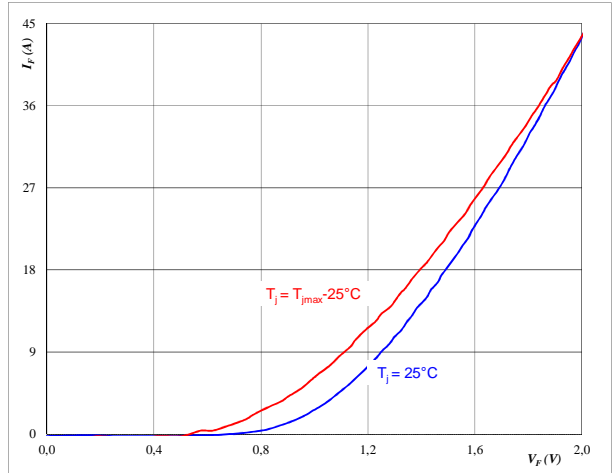

At
 $t_p = 250 \mu s$



Output Inverter

figure 5. IGBT

Typical switching energy losses as a function of collector current

$$E = f(I_C)$$

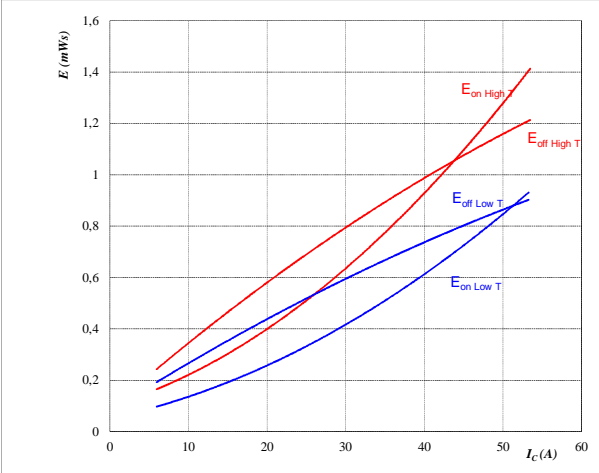

With an inductive load at

$T_j =$	25/125	°C
$V_{CE} =$	300	V
$V_{GE} =$	±15	V
$R_{gon} =$	16	Ω
$R_{goff} =$	16	Ω

figure 6. IGBT

Typical switching energy losses as a function of gate resistor

$$E = f(R_G)$$

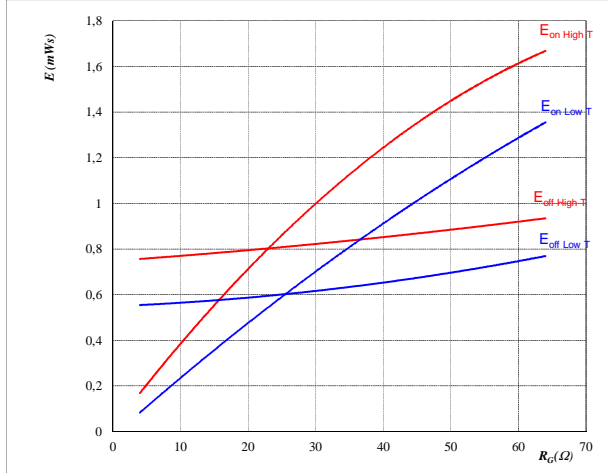

With an inductive load at

$T_j =$	25/125	°C
$V_{CE} =$	300	V
$V_{GE} =$	±15	V
$I_C =$	30	A

figure 7. FWD

Typical reverse recovery energy loss as a function of collector current

$$E_{rec} = f(I_C)$$

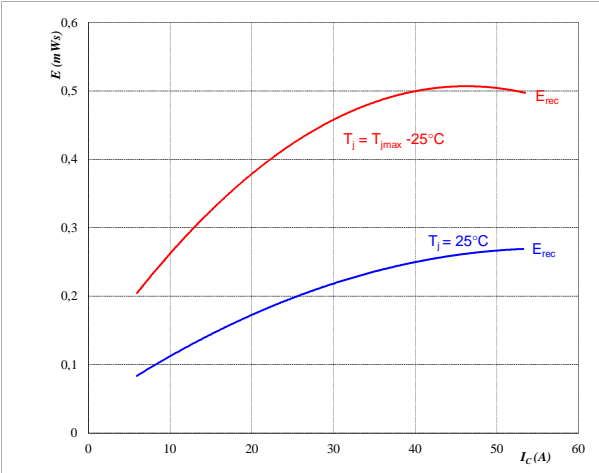

With an inductive load at

$T_j =$	25/125	°C
$V_{CE} =$	300	V
$V_{GE} =$	±15	V
$R_{gon} =$	16	Ω

figure 8. FWD

Typical reverse recovery energy loss as a function of gate resistor

$$E_{rec} = f(R_G)$$

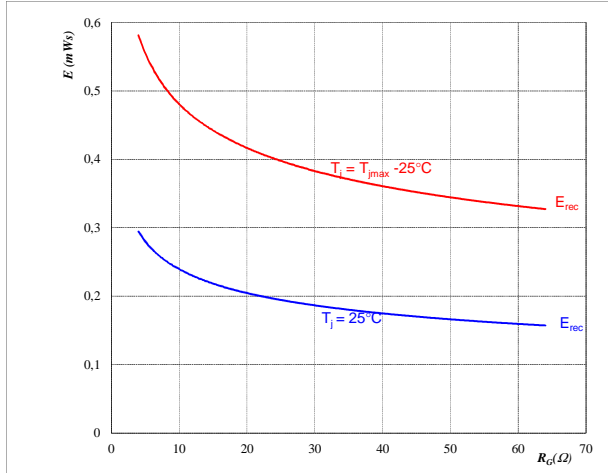

With an inductive load at

$T_j =$	25/125	°C
$V_{CE} =$	300	V
$V_{GE} =$	±15	V
$I_C =$	30	A



Output Inverter

figure 9. IGBT

Typical switching times as a function of collector current

$$t = f(I_C)$$

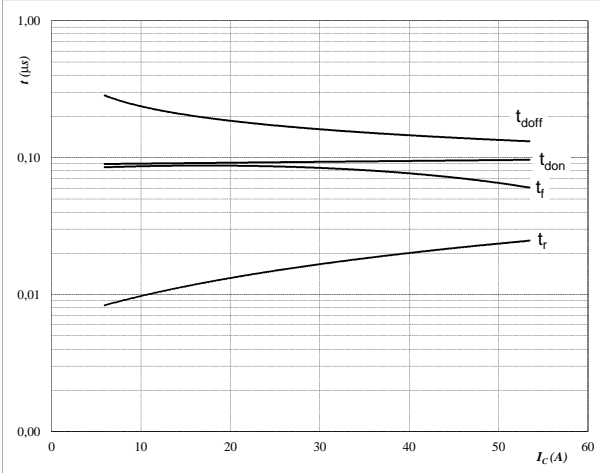

With an inductive load at

$T_j =$	125	°C
$V_{CE} =$	300	V
$V_{GE} =$	±15	V
$R_{gon} =$	16	Ω
$R_{goff} =$	16	Ω

figure 10. IGBT

Typical switching times as a function of gate resistor

$$t = f(R_G)$$

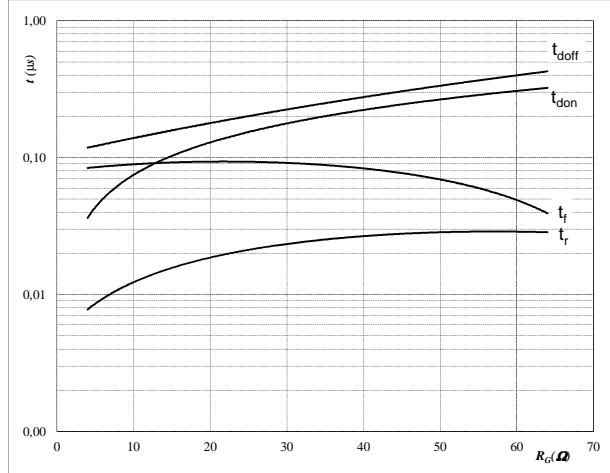

With an inductive load at

$T_j =$	125	°C
$V_{CE} =$	300	V
$V_{GE} =$	±15	V
$I_C =$	30	A

figure 11. FWD

Typical reverse recovery time as a function of collector current

$$t_{rr} = f(I_C)$$

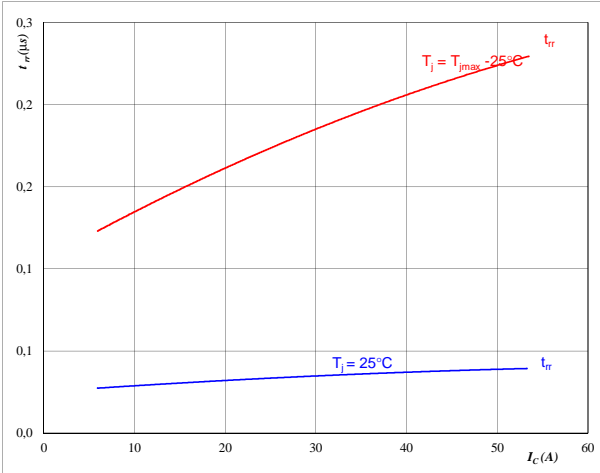

At

$T_j =$	25/125	°C
$V_{CE} =$	300	V
$V_{GE} =$	±15	V
$R_{gon} =$	16	Ω

figure 12. FWD

Typical reverse recovery time as a function of IGBT turn on gate resistor

$$t_{rr} = f(R_{gon})$$

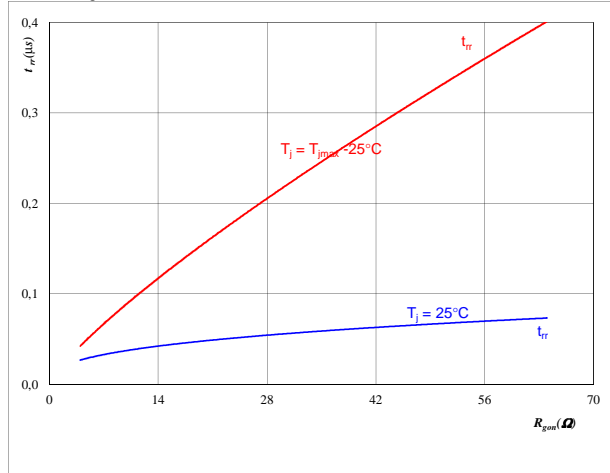

At

$T_j =$	25/125	°C
$V_R =$	300	V
$I_F =$	30	A
$V_{GE} =$	±15	V



Output Inverter

figure 13. FWD

Typical reverse recovery charge as a function of collector current

$$Q_{rr} = f(I_c)$$

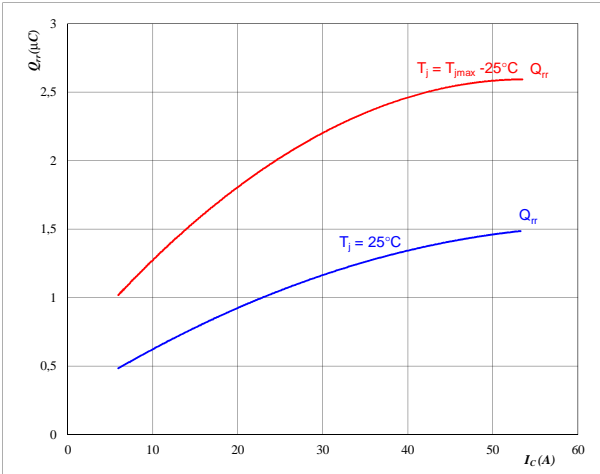

At
 $T_j = 25/125 \text{ } ^\circ\text{C}$
 $V_{CE} = 300 \text{ V}$
 $V_{GE} = \pm 15 \text{ V}$
 $R_{gon} = 16 \text{ } \Omega$

figure 14. FWD

Typical reverse recovery charge as a function of IGBT turn on gate resistor

$$Q_{rr} = f(R_{gon})$$

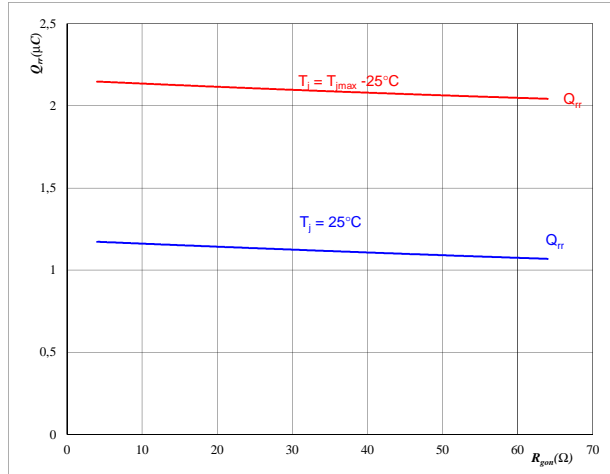

At
 $T_j = 25/125 \text{ } ^\circ\text{C}$
 $V_R = 300 \text{ V}$
 $I_F = 30 \text{ A}$
 $V_{GE} = \pm 15 \text{ V}$

figure 15. FWD

Typical reverse recovery current as a function of collector current

$$I_{RRM} = f(I_c)$$

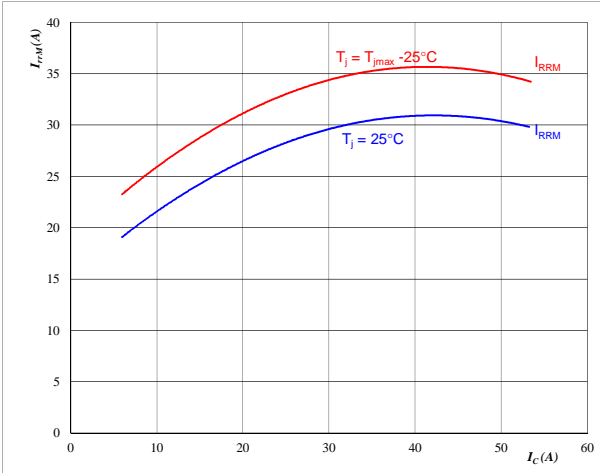

At
 $T_j = 25/125 \text{ } ^\circ\text{C}$
 $V_{CE} = 300 \text{ V}$
 $V_{GE} = \pm 15 \text{ V}$
 $R_{gon} = 16 \text{ } \Omega$

figure 16. FWD

Typical reverse recovery current as a function of IGBT turn on gate resistor

$$I_{RRM} = f(R_{gon})$$

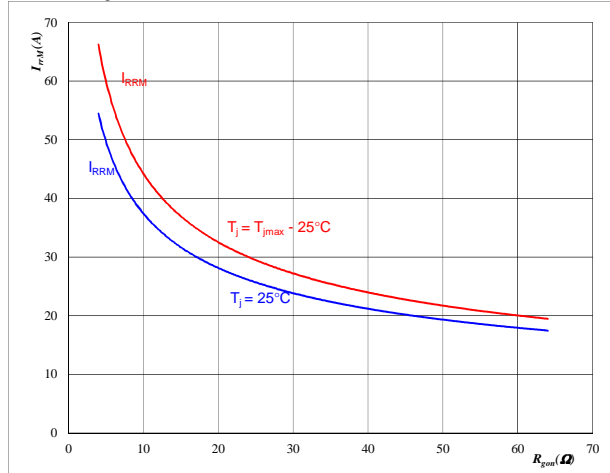

At
 $T_j = 25/125 \text{ } ^\circ\text{C}$
 $V_R = 300 \text{ V}$
 $I_F = 30 \text{ A}$
 $V_{GE} = \pm 15 \text{ V}$



Output Inverter

figure 17. FWD

Typical rate of fall of forward and reverse recovery current as a function of collector current

$$dI_o/dt, dI_{rec}/dt = f(I_c)$$

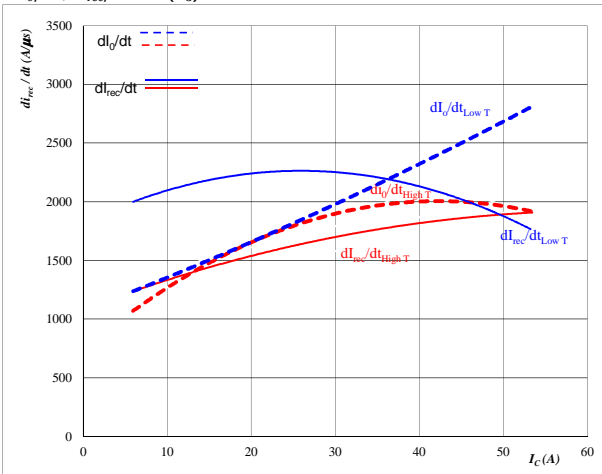

At
 $T_j = 25/125 \text{ } ^\circ\text{C}$
 $V_{CE} = 300 \text{ V}$
 $V_{GE} = \pm 15 \text{ V}$
 $R_{gon} = 16 \text{ } \Omega$

figure 18. FWD

Typical rate of fall of forward and reverse recovery current as a function of IGBT turn on gate resistor

$$dI_o/dt, dI_{rec}/dt = f(R_{gon})$$

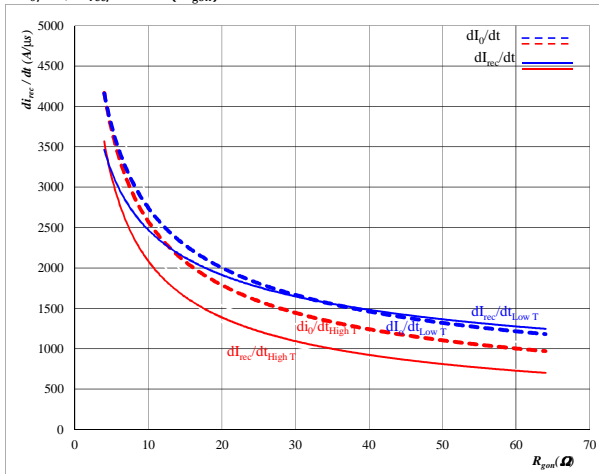

At
 $T_j = 25/125 \text{ } ^\circ\text{C}$
 $V_R = 300 \text{ V}$
 $I_F = 30 \text{ A}$
 $V_{GE} = \pm 15 \text{ V}$

figure 19. IGBT

IGBT transient thermal impedance as a function of pulse width

$$Z_{th(j-s)} = f(t_p)$$

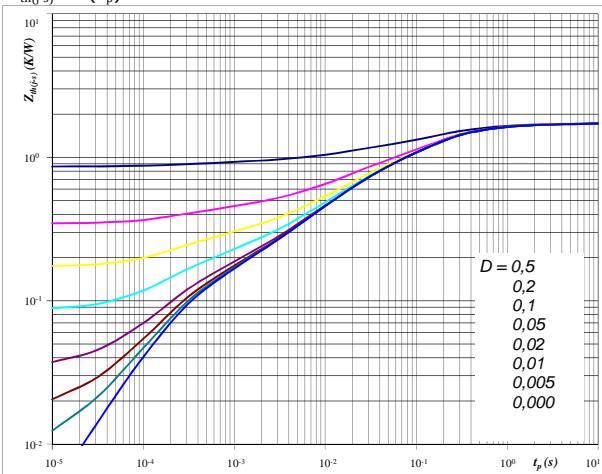

At
 $D = t_p / T$ Phase change material
 $R_{th(j-s)} = 1,60 \text{ K/W}$ $R_{th(j-s)} = 1,37 \text{ K/W}$

IGBT thermal model values		Phase change material	
R (K/W)	Tau (s)	R (K/W)	Tau (s)
7,97E-02	2,79E+00	8,08E-02	1,65E+00
3,32E-01	3,84E-01	1,77E-01	2,46E-01
6,25E-01	1,06E-01	7,50E-01	6,44E-02
3,61E-01	1,55E-02	1,99E-01	1,77E-02
1,04E-01	2,61E-03	9,61E-02	4,57E-03
9,94E-02	2,47E-04	7,05E-02	6,56E-04

figure 20. FWD

FWD transient thermal impedance as a function of pulse width

$$Z_{th(j-s)} = f(t_p)$$

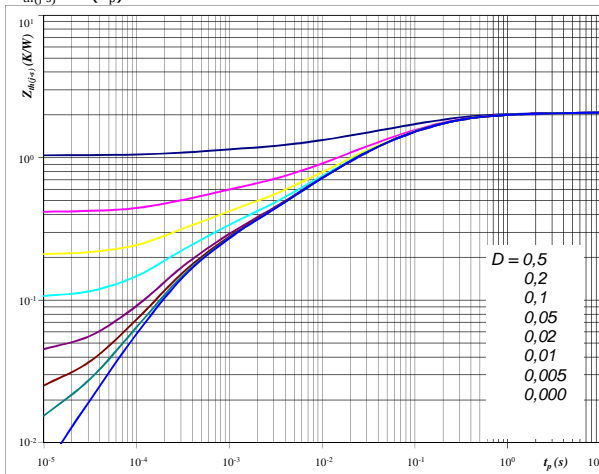

At
 $D = t_p / T$ Phase change material
 $R_{th(j-s)} = 2,07 \text{ K/W}$ $R_{th(j-s)} = 1,81 \text{ K/W}$

FWD thermal model values		Phase change material	
R (K/W)	Tau (s)	R (K/W)	Tau (s)
9,03E-02	2,69E+00	8,32E-02	4,59E+00
3,61E-01	3,13E-01	2,00E-01	4,81E-01
7,18E-01	7,88E-02	7,57E-01	9,25E-02
5,19E-01	1,60E-02	4,20E-01	1,80E-02
2,11E-01	2,84E-03	2,12E-01	3,31E-03
1,77E-01	3,27E-04	1,39E-01	3,46E-04



Output Inverter

figure 21. IGBT

Power dissipation as a function of heatsink temperature

$P_{tot} = f(T_s)$

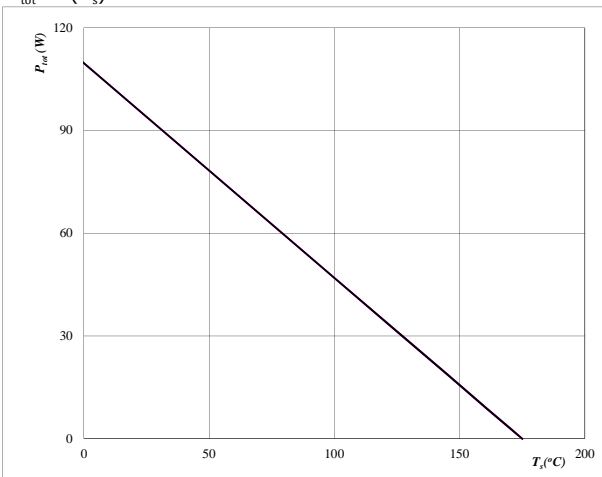

At
T_j = 175 °C

figure 22. IGBT

Collector current as a function of heatsink temperature

$I_C = f(T_s)$

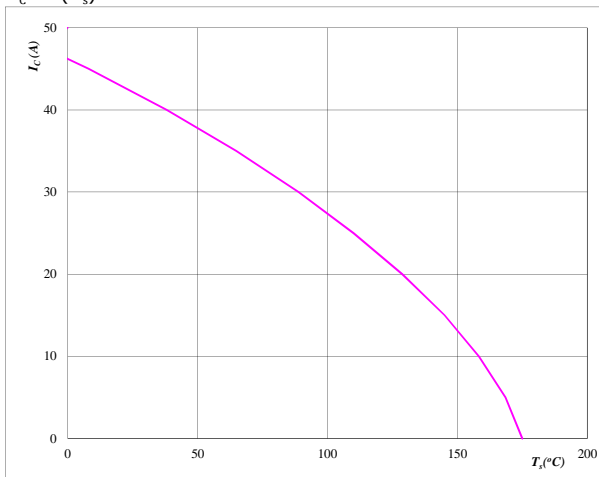

At
T_j = 175 °C
V_{GE} = 15 V

figure 23. FWD

Power dissipation as a function of heatsink temperature

$P_{tot} = f(T_s)$

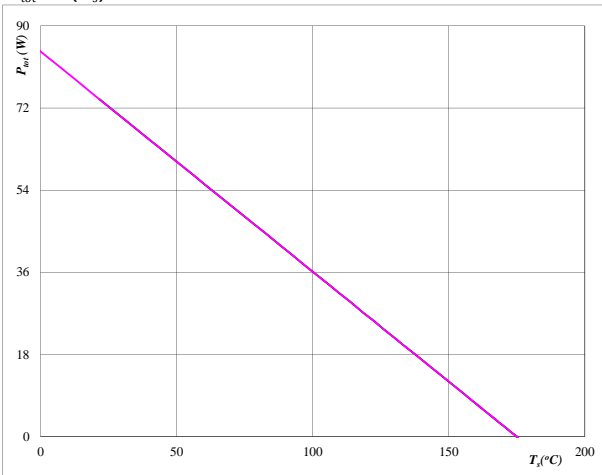

At
T_j = 175 °C

figure 24. FWD

Forward current as a function of heatsink temperature

$I_F = f(T_s)$

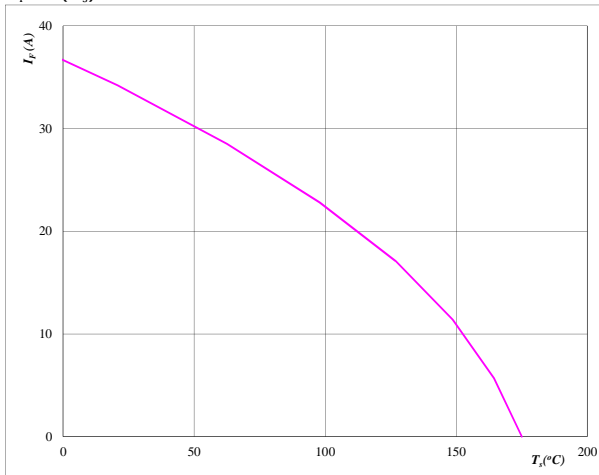

At
T_j = 175 °C



Output Inverter

figure 25. IGBT

Safe operating area as a function of collector-emitter voltage

$I_C = f(V_{CE})$

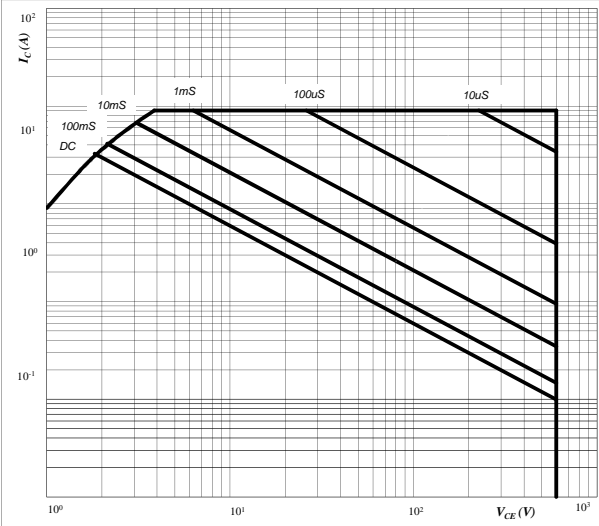

At
 $D =$ single pulse
 $T_s =$ 80 °C
 $V_{GE} =$ ±15 V
 $T_j = T_{jmax}$

figure 26. IGBT

Gate voltage vs Gate charge

$V_{GE} = f(Q_g)$

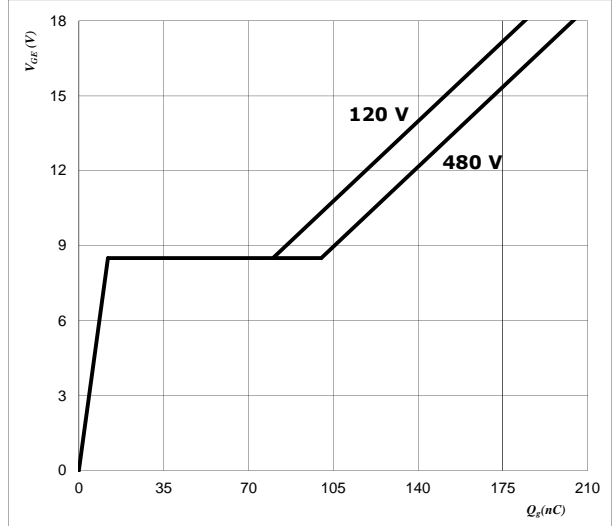

At
 $I_C =$ 30 A

figure 27. IGBT

Short circuit withstand time as a function of gate-emitter voltage

$t_{sc} = f(V_{GE})$

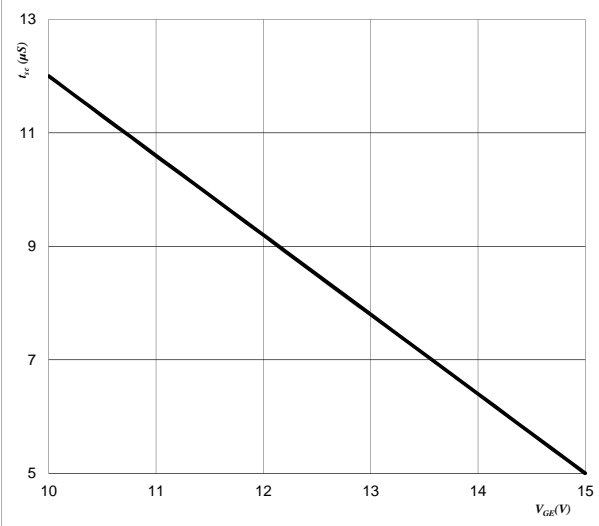

At
 $V_{CE} =$ 600 V
 $T_j \leq$ 175 °C

figure 28. IGBT

Typical short circuit collector current as a function of gate-emitter voltage

$I_{C(sc)} = f(V_{GE})$

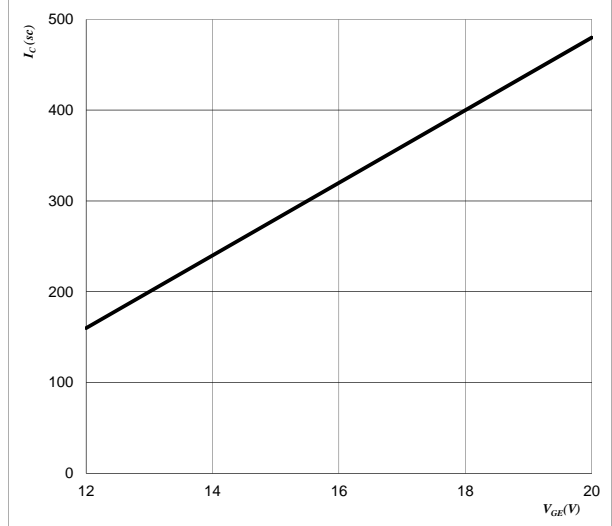

At
 $V_{CE} \leq$ 600 V
 $T_j =$ 175 °C



Output Inverter

figure 29. IGBT
Reverse bias safe operating area

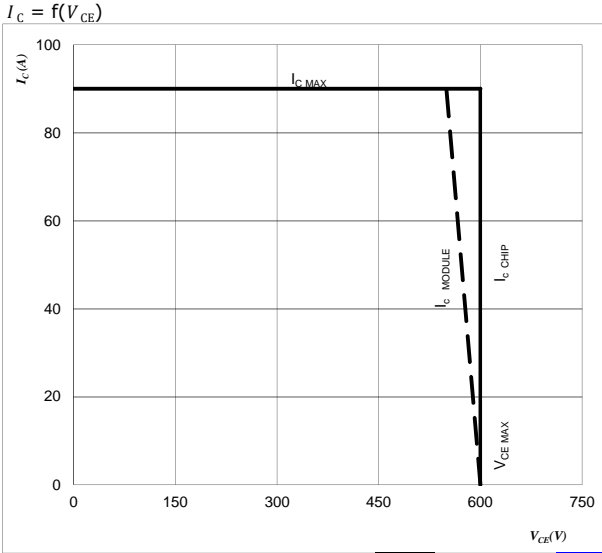

At
 $T_j = T_{j,max} - 25 \text{ } ^\circ\text{C}$



Brake

figure 1. IGBT

Typical output characteristics

$I_C = f(V_{CE})$

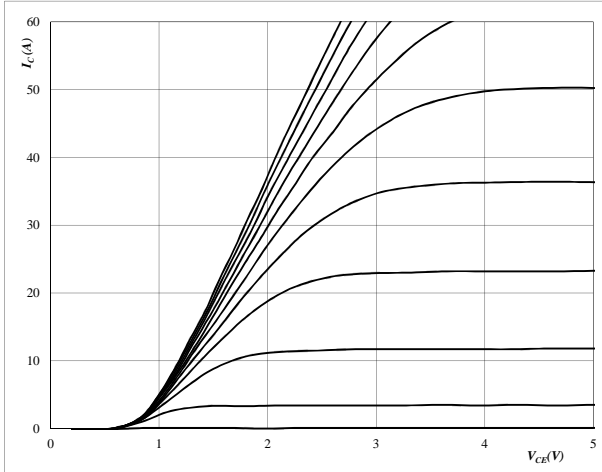

At

$t_p = 250 \mu s$
 $T_j = 25 \text{ } ^\circ C$
 V_{GE} from 7 V to 17 V in steps of 1 V

figure 2. IGBT

Typical output characteristics

$I_C = f(V_{CE})$

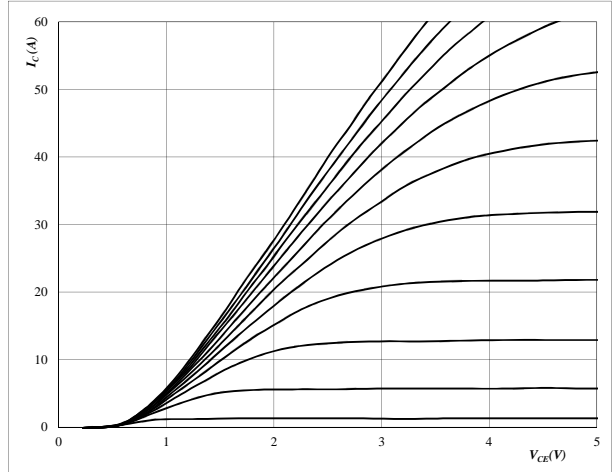

At

$t_p = 250 \mu s$
 $T_j = 125 \text{ } ^\circ C$
 V_{GE} from 7 V to 17 V in steps of 1 V

figure 3. IGBT

Typical transfer characteristics

$I_C = f(V_{GE})$

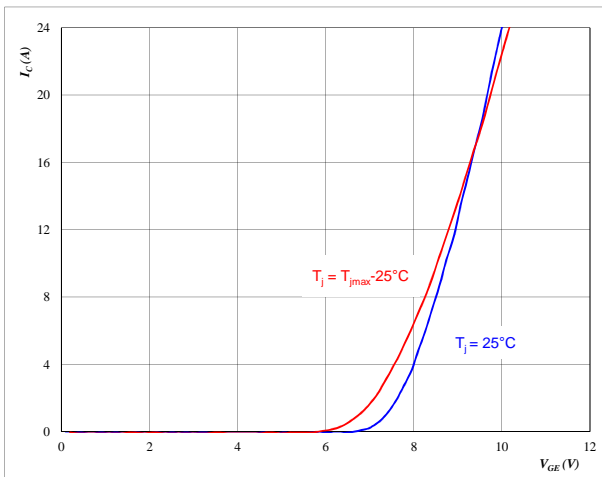

At

$t_p = 250 \mu s$
 $V_{CE} = 10 V$

figure 4. FWD

Typical diode forward current as a function of forward voltage

$I_F = f(V_F)$

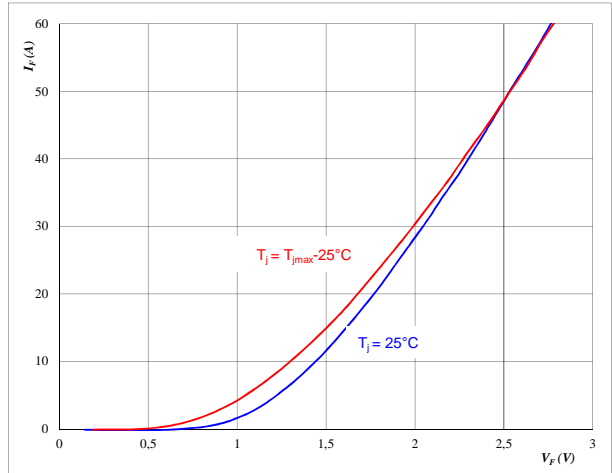

At

$t_p = 250 \mu s$



Brake

figure 5. IGBT

Typical switching energy losses as a function of collector current

$E = f(I_C)$

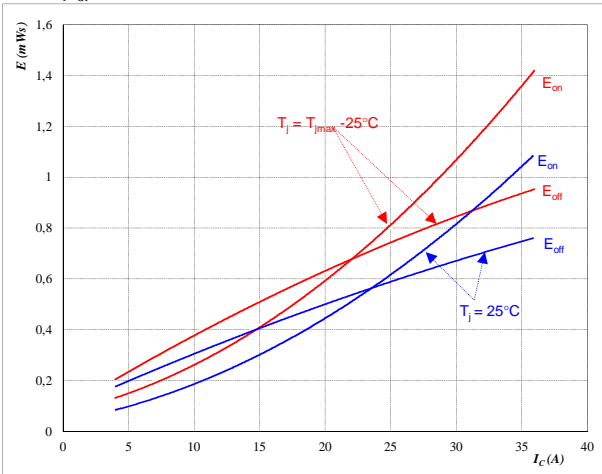

With an inductive load at

- $T_j = 25/125 \text{ } ^\circ\text{C}$
- $V_{CE} = 300 \text{ V}$
- $V_{GE} = \pm 15 \text{ V}$
- $R_{gon} = 32 \text{ } \Omega$
- $R_{goff} = 32 \text{ } \Omega$

figure 6. IGBT

Typical switching energy losses as a function of gate resistor

$E = f(R_G)$

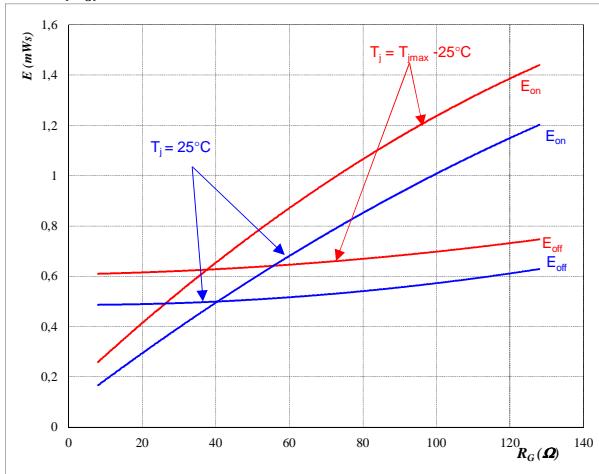

With an inductive load at

- $T_j = 25/125 \text{ } ^\circ\text{C}$
- $V_{CE} = 300 \text{ V}$
- $V_{GE} = \pm 15 \text{ V}$
- $I_C = 20 \text{ A}$

figure 7. FWD

Typical reverse recovery energy loss as a function of collector current

$E_{rec} = f(I_C)$

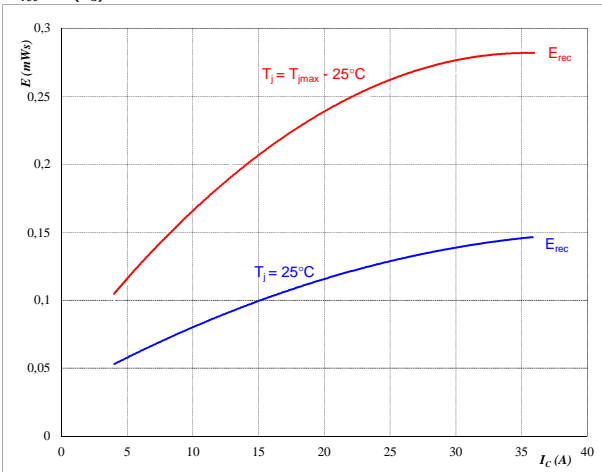

With an inductive load at

- $T_j = 25/125 \text{ } ^\circ\text{C}$
- $V_{CE} = 300 \text{ V}$
- $V_{GE} = \pm 15 \text{ V}$
- $R_{gon} = 32 \text{ } \Omega$

figure 8. FWD

Typical reverse recovery energy loss as a function of gate resistor

$E_{rec} = f(R_G)$

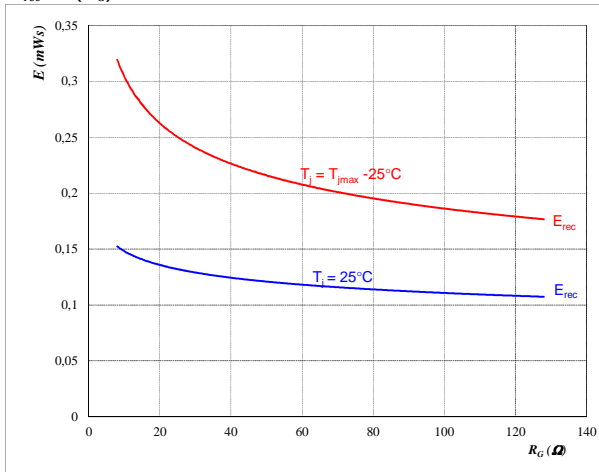

With an inductive load at

- $T_j = 25/125 \text{ } ^\circ\text{C}$
- $V_{CE} = 300 \text{ V}$
- $V_{GE} = \pm 15 \text{ V}$
- $I_C = 20 \text{ A}$



Brake

figure 9. IGBT

Typical switching times as a function of collector current
 $t = f(I_c)$

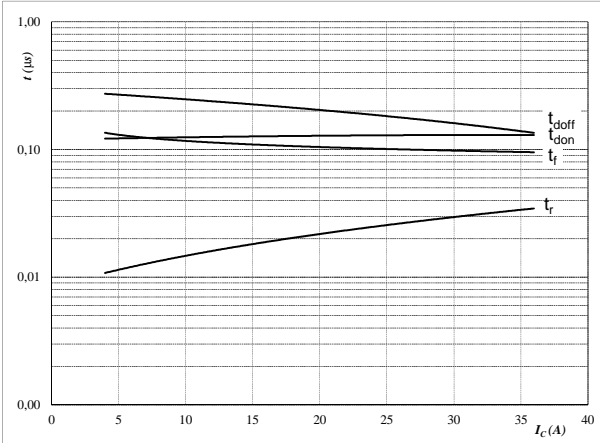

With an inductive load at
 $T_j = 125 \text{ } ^\circ\text{C}$
 $V_{CE} = 300 \text{ V}$
 $V_{GE} = \pm 15 \text{ V}$
 $R_{gon} = 32 \text{ } \Omega$
 $R_{goff} = 32 \text{ } \Omega$

figure 10. IGBT

Typical switching times as a function of gate resistor
 $t = f(R_g)$

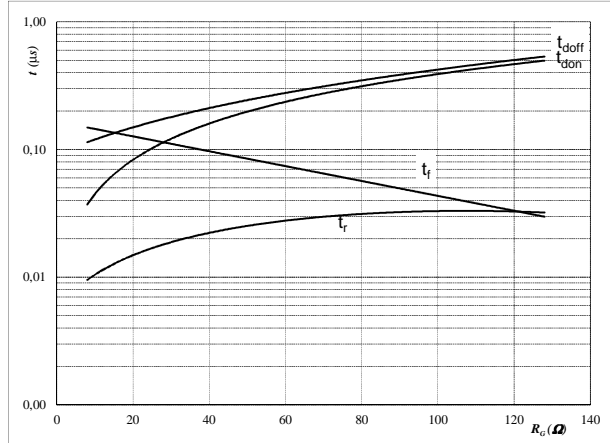

With an inductive load at
 $T_j = 125 \text{ } ^\circ\text{C}$
 $V_{CE} = 300 \text{ V}$
 $V_{GE} = \pm 15 \text{ V}$
 $I_c = 20 \text{ A}$

figure 11. IGBT

IGBT transient thermal impedance as a function of pulse width
 $Z_{th(j-s)} = f(t_p)$

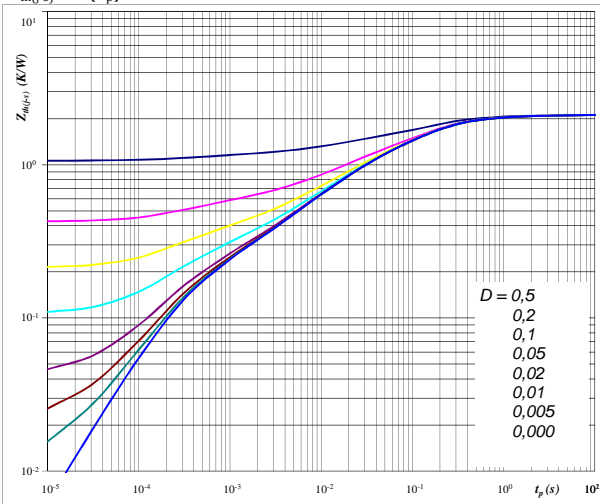

At $D = t_p / T$
 Thermal grease $R_{th(j-s)} = 2,12 \text{ K/W}$
 Phase change material $R_{th(j-s)} = 1,83 \text{ K/W}$

figure 12. FWD

FWD transient thermal impedance as a function of pulse width
 $Z_{th(j-s)} = f(t_p)$

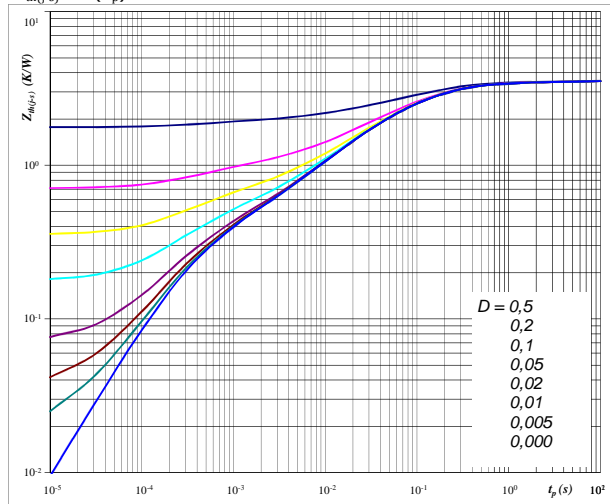

At $D = t_p / T$
 Thermal grease $R_{th(j-s)} = 3,53 \text{ K/W}$
 Phase change material $R_{th(j-s)} = 3,07 \text{ K/W}$



Brake

figure 13. IGBT

Power dissipation as a function of heatsink temperature

$$P_{tot} = f(T_s)$$

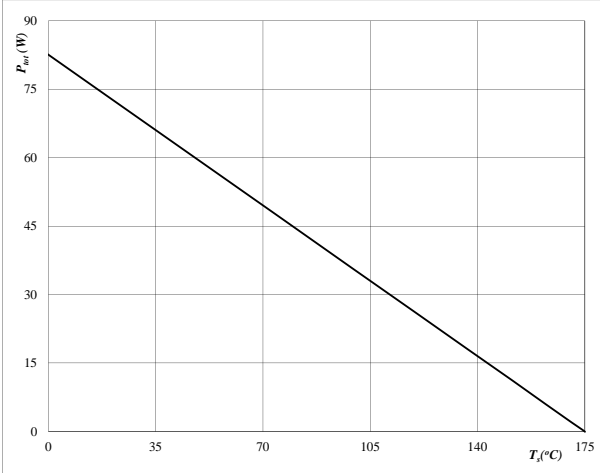

At
T_j = 175 °C

figure 14. IGBT

Collector current as a function of heatsink temperature

$$I_C = f(T_s)$$

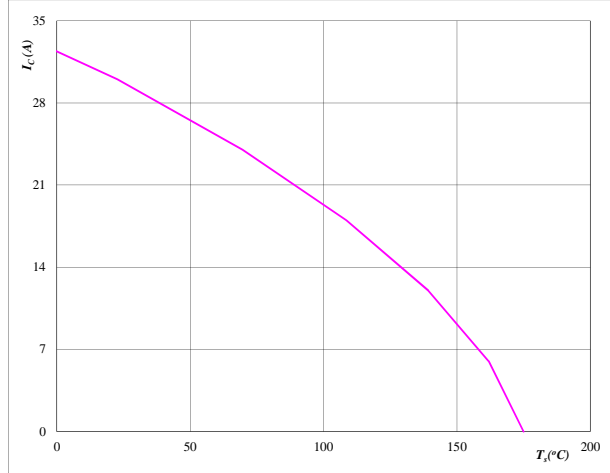

At
T_j = 175 °C
V_{GE} = 15 V

figure 15. FWD

Power dissipation as a function of heatsink temperature

$$P_{tot} = f(T_s)$$

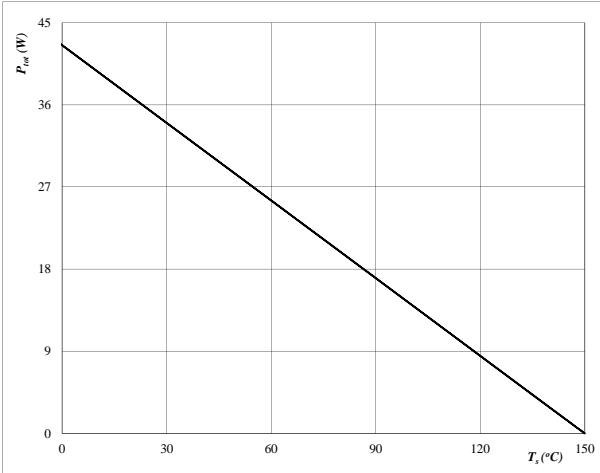

At
T_j = 150 °C

figure 16. FWD

Forward current as a function of heatsink temperature

$$I_F = f(T_s)$$

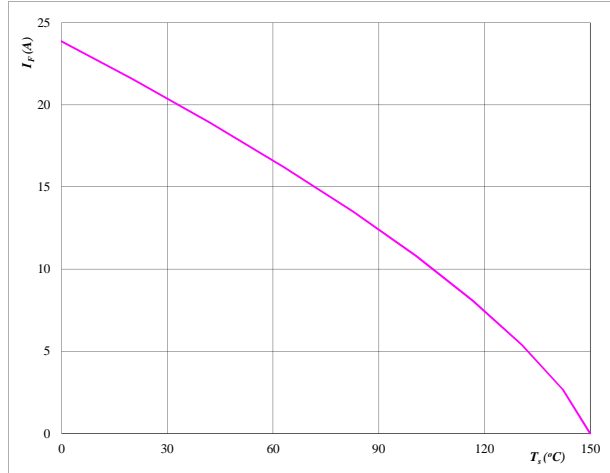

At
T_j = 150 °C



Input Rectifier Bridge

figure 1. Rectifier Diode

Typical diode forward current as a function of forward voltage

$I_F = f(V_F)$

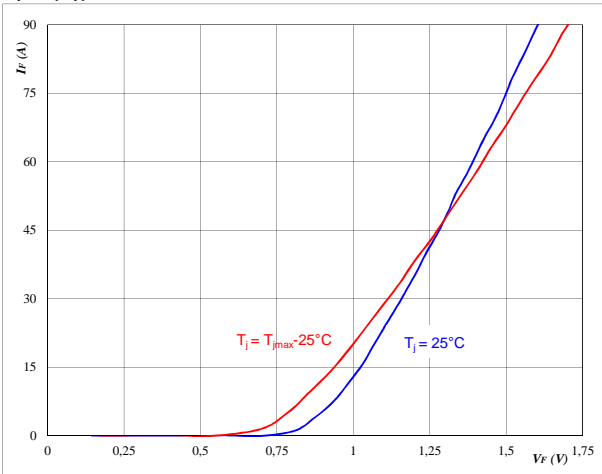

At
 $t_p = 250 \mu s$

figure 2. Rectifier Diode

Diode transient thermal impedance as a function of pulse width

$Z_{th(j-s)} = f(t_p)$

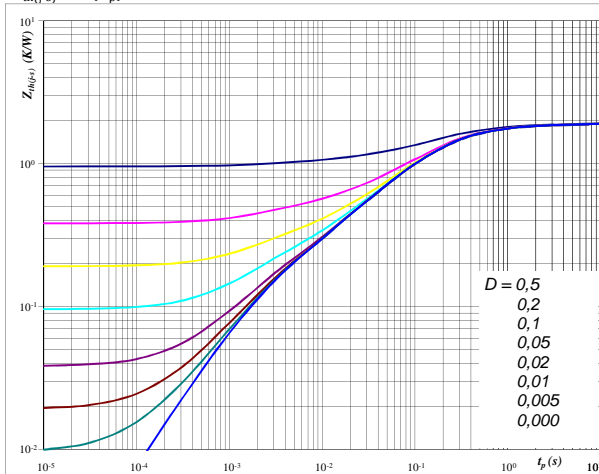

At
 $D = t_p / T$
Thermal grease
 $R_{th(j-s)} = 1,89 \text{ K/W}$
Phase change material
 $R_{th(j-s)} = 1,62 \text{ K/W}$

figure 3. Rectifier Diode

Power dissipation as a function of heatsink temperature

$P_{tot} = f(T_s)$

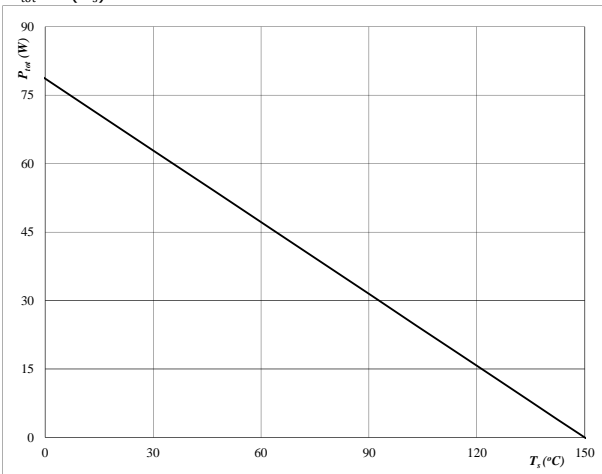

At
 $T_j = 150 \text{ °C}$

figure 4. Rectifier Diode

Forward current as a function of heatsink temperature

$I_F = f(T_s)$

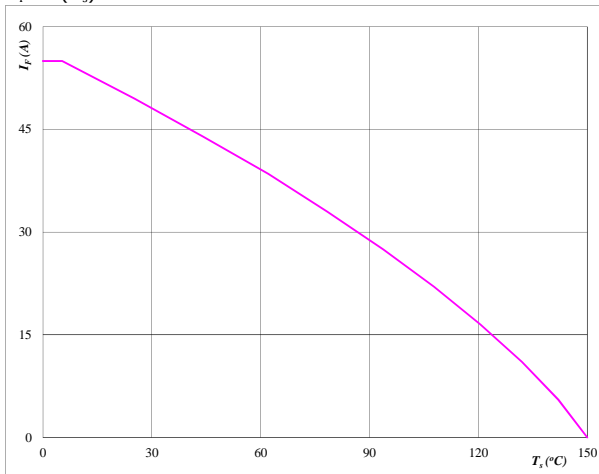

At
 $T_j = 150 \text{ °C}$



Thermistor

figure 1. Thermistor

Typical NTC characteristic as a function of temperature

$$R_T = f(T)$$

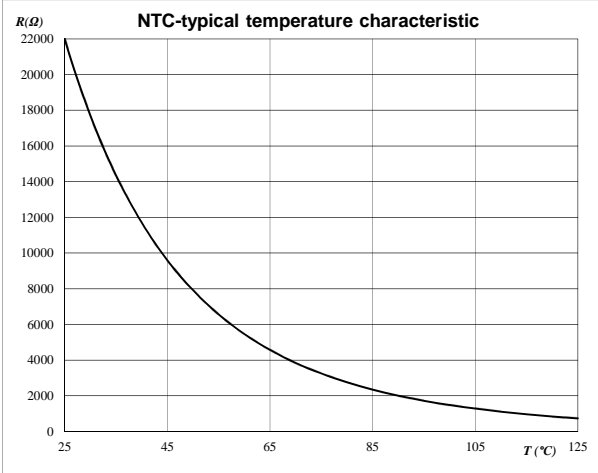

figure 2. Thermistor

Typical NTC resistance values

$$R(T) = R_{25} \cdot e^{\left(B_{25/100} \left(\frac{1}{T} - \frac{1}{T_{25}} \right) \right)} \quad [\Omega]$$

T [°C]	R _{nom} [Ω]	R _{min} [Ω]	R _{max} [Ω]	ΔR/R [±%]
-55	2089434,5	1506495,4	2672373,6	27,9
0	71804,2	59724,4	83884	16,8
10	43780,4	37094,4	50466,5	15,3
20	27484,6	23684,6	31284,7	13,8
25	22000	19109,3	24890,7	13,1
30	17723,3	15512,2	19934,4	12,5
60	5467,9	4980,6	5955,1	8,9
70	3848,6	3546	4151,1	7,9
80	2757,7	2568,2	2947,1	6,9
90	2008,9	1889,7	2128,2	5,9
100	1486,1	1411,8	1560,4	5
150	400,2	364,8	435,7	8,8



Switching Definitions Output Inverter

General conditions

T_j	=	125 °C
R_{gon}	=	4Ω
R_{goff}	=	4Ω

figure 1. IGBT

Turn-off Switching Waveforms & definition of t_{doff} , t_{Eoff}
(t_{Eoff} = integrating time for E_{off})

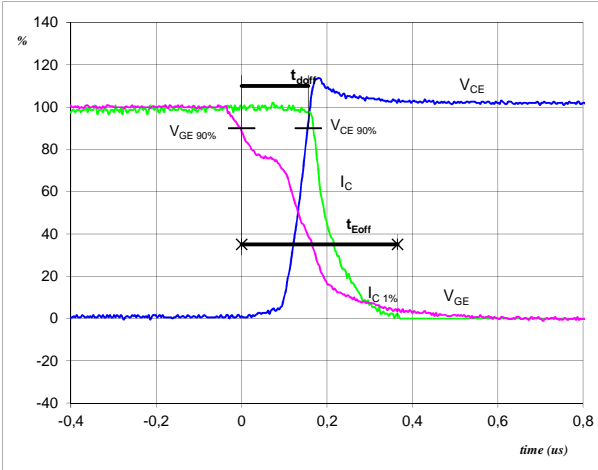

V_{GE} (0%) =	-15	V
V_{GE} (100%) =	15	V
V_C (100%) =	300	V
I_C (100%) =	30	A
t_{doff} =	0,16	μs
t_{Eoff} =	0,37	μs

figure 2. IGBT

Turn-on Switching Waveforms & definition of t_{don} , t_{Eon}
(t_{Eon} = integrating time for E_{on})

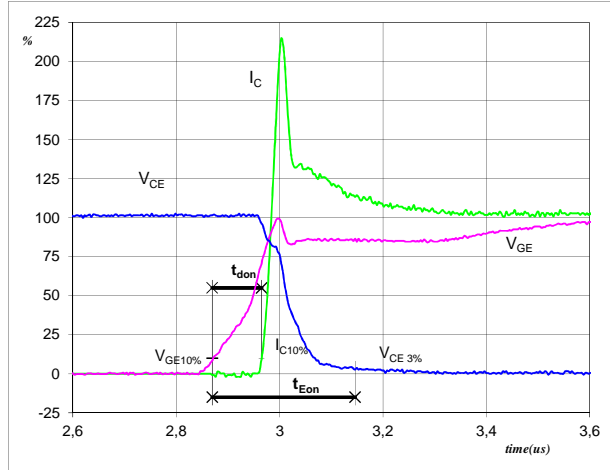

V_{GE} (0%) =	-15	V
V_{GE} (100%) =	15	V
V_C (100%) =	300	V
I_C (100%) =	30	A
t_{don} =	0,09	μs
t_{Eon} =	0,28	μs

figure 3. IGBT

Turn-off Switching Waveforms & definition of t_f

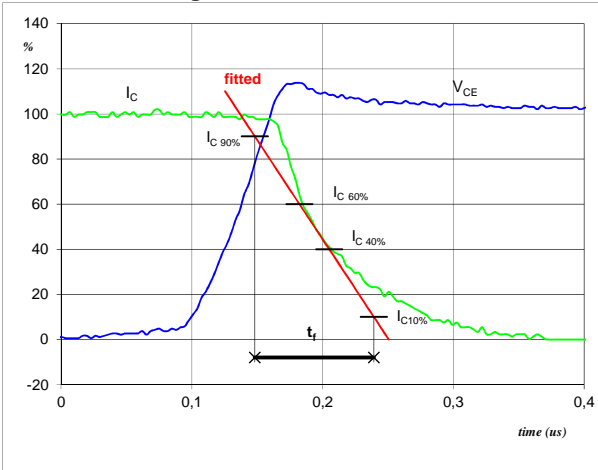

V_C (100%) =	300	V
I_C (100%) =	30	A
t_f =	0,09	μs

figure 4. IGBT

Turn-on Switching Waveforms & definition of t_r

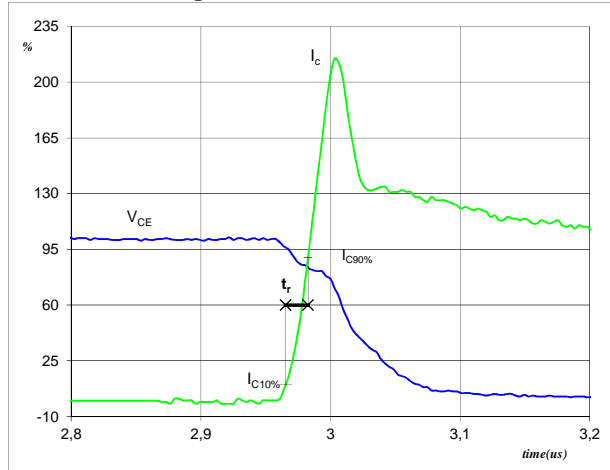

V_C (100%) =	300	V
I_C (100%) =	30	A
t_r =	0,02	μs



Switching Definitions Output Inverter

figure 5. IGBT

Turn-off Switching Waveforms & definition of t_{Eoff}

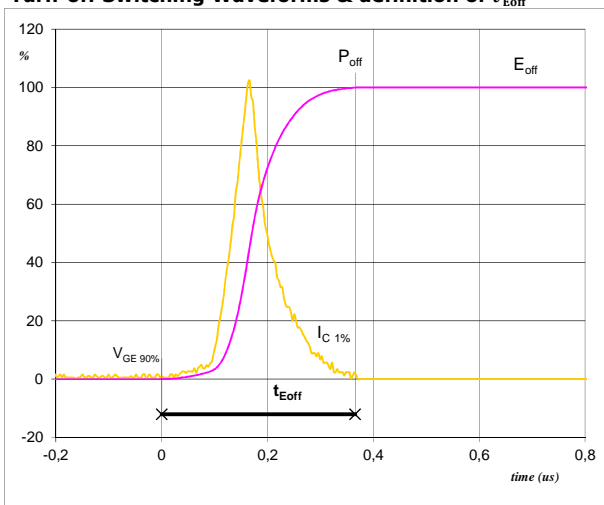

$P_{off} (100\%) = 8,95 \text{ kW}$
 $E_{off} (100\%) = 0,80 \text{ mJ}$
 $t_{Eoff} = 0,37 \text{ } \mu\text{s}$

figure 6. IGBT

Turn-on Switching Waveforms & definition of t_{Eon}

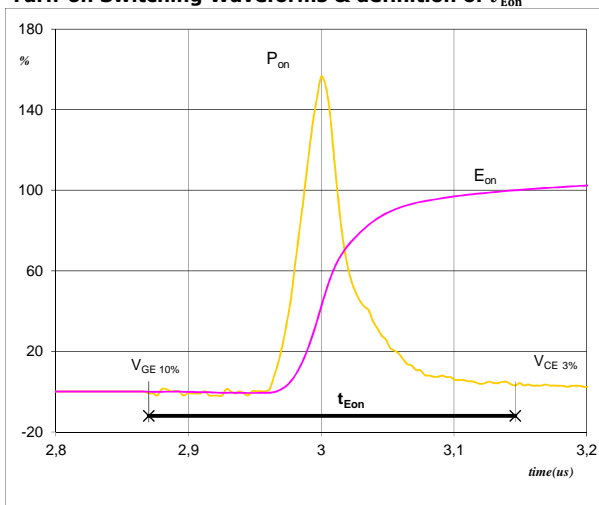

$P_{on} (100\%) = 8,95 \text{ kW}$
 $E_{on} (100\%) = 0,63 \text{ mJ}$
 $t_{Eon} = 0,28 \text{ } \mu\text{s}$

figure 7. IGBT

Turn-off Switching Waveforms & definition of t_{rr}

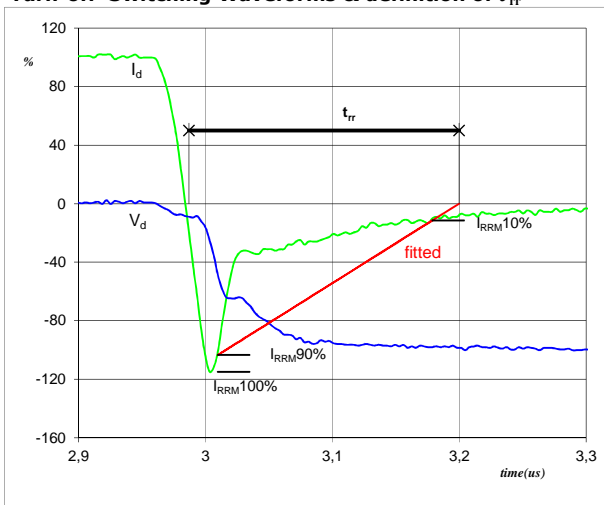

$V_d (100\%) = 300 \text{ V}$
 $I_d (100\%) = 30 \text{ A}$
 $I_{RRM} (100\%) = 34 \text{ A}$
 $t_{rr} = 0,18 \text{ } \mu\text{s}$



Switching Definitions Output Inverter

figure 8. FWD

Turn-on Switching Waveforms & definition of t_{Qrr}
(t_{Qrr} = integrating time for Q_{rr})

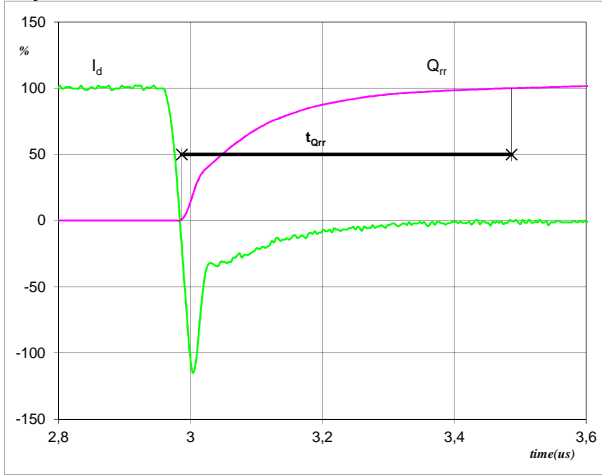

I_d (100%) =	30	A
Q_{rr} (100%) =	2,16	μC
t_{Qrr} =	0,50	μs

figure 9. FWD

Turn-on Switching Waveforms & definition of t_{Erec}
(t_{Erec} = integrating time for E_{rec})

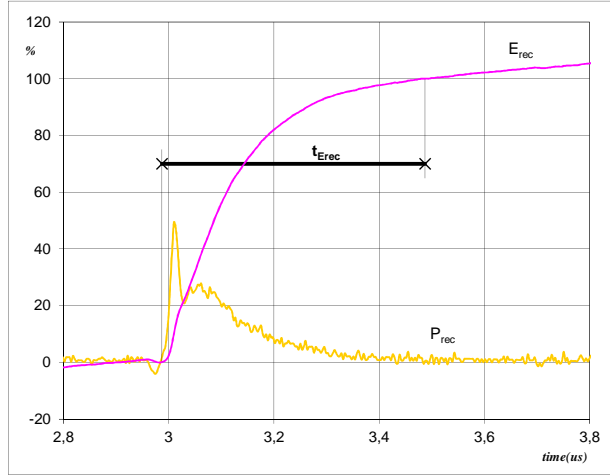

P_{rec} (100%) =	8,95	kW
E_{rec} (100%) =	0,45	mJ
t_{Erec} =	0,50	μs



Ordering Code & Marking

Version	Ordering Code
without thermal paste 17 mm housing with solder pins	V23990-P585-A20-PM
without thermal paste 17 mm housing with pressfit pins	V23990-P585-A20Y-PM
without thermal paste 12 mm housing with solder pins	V23990-P585-A208-PM
without thermal paste 12 mm housing with pressfit pins	V23990-P585-A208Y-PM
without thermal paste 12 mm 2 clips housing with solder pins	10-TY06PMA030SA-P585A206
without thermal paste 17 mm housing with solder pins	V23990-P585-C20-PM
without thermal paste 17 mm housing with pressfit pins	V23990-P585-C20Y-PM
with thermal paste 17 mm housing with solder pins	V23990-P585-A20-/3/-PM
with thermal paste 17 mm housing with pressfit pins	V23990-P585-A20Y-/3/-PM
with thermal paste 12 mm housing with solder pins	V23990-P585-A208-/3/-PM
with thermal paste 12 mm housing with pressfit pins	V23990-P585-A208Y-/3/-PM
with thermal paste 12 mm 2 clips housing with solder pins	10-TY06PMA030SA-P585A206
with thermal paste 17 mm housing with solder pins	V23990-P585-C20-/3/-PM
with thermal paste 17 mm housing with pressfit pins	V23990-P585-C20Y-/3/-PM

		Text	VIN	Date code	Name&Ver	UL	Lot	Serial
			VIN	WWYY	NNNNNVV	UL	LLLLL	SSSS
		Datamatrix	Type&Ver	Lot number	Serial	Date code		
			TTTTTIVV	LLLLL	SSSS	WWYY		

Outline

Pin table				module	whitout pins
Pin	X	Y	Function	P585-C20	1, 31, 32
1	52,6	0	BrG	P585-C20Y	1, 31, 32
2	47,7	0	DC-		
3	44,8	0	DC-		
4	37,8	0	DC+	12 mm solder pin	
5	37,8	2,8	DC+		
6	35	0	Inv+		
7	35	2,8	Inv+		
8	28	0	R1	12 mm press-fit pin	
9	25,2	0	R2		
10	22,4	0	N6		
11	19,6	0	G6		
12	16,8	0	S6		
13	14	0	N4	17 mm solder pin	
14	11,2	0	G4		
15	8,4	0	S4		
16	5,6	0	N2		
17	2,8	0	G2		
18	0	0	S2		
19	0	28,5	U	17 mm press-fit pin	
20	2,8	28,5	G1		
21	7,5	28,5	S1		
22	14,5	28,5	V		
23	17,3	28,5	G3		
24	22	28,5	S3		
25	29	28,5	W		
26	31,8	28,5	G5		
27	36,5	28,5	S5	12mm solder pin / 2 clips	
28	43,5	28,5	L1		
29	52,6	25	L2		
30	52,6	16,9	L3		
31	52,6	8,6	BrC		
32	52,6	2,8	BrE		

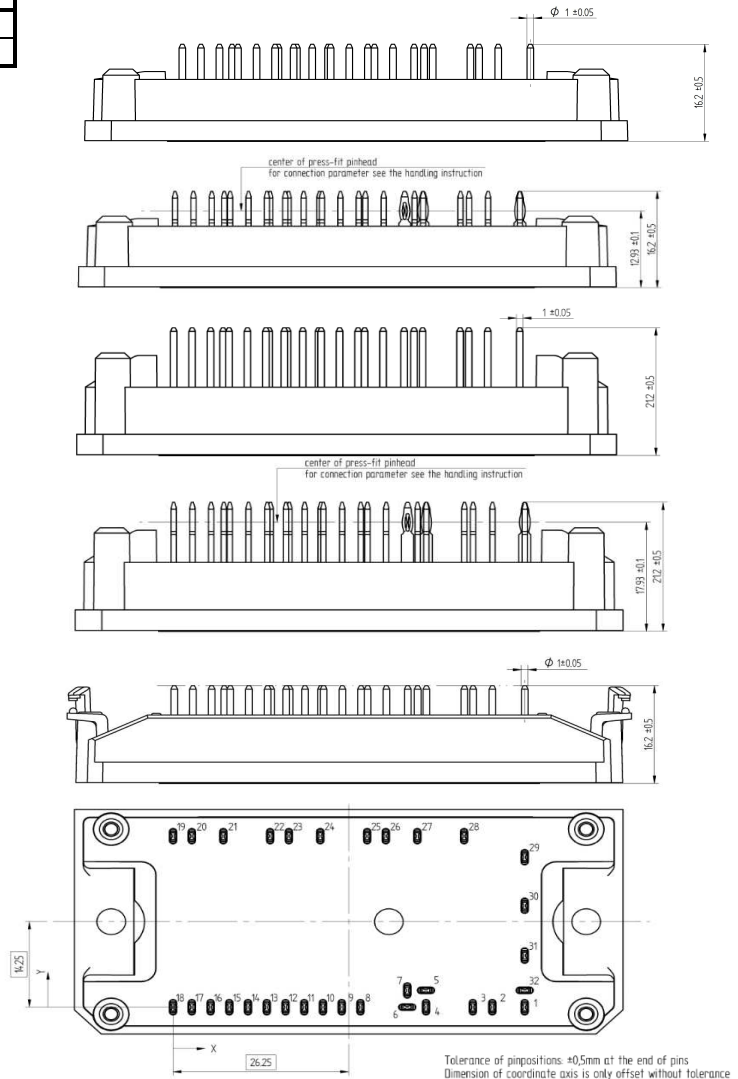

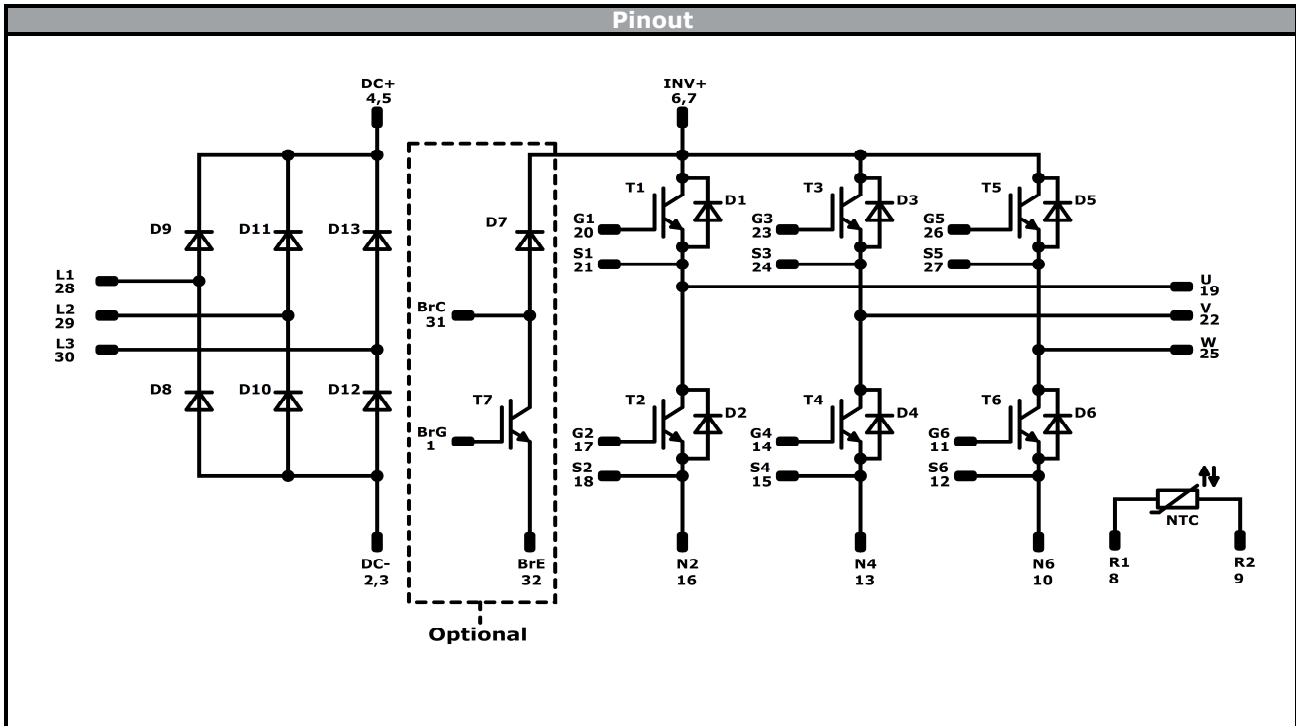

Identification					
ID	Component	Voltage	Current	Function	Comment
T1,T2,T3,T4,T5,T6	IGBT	1200 V	30 A	Inverter Switch	
D1,D2,D3,D4,D5,D6	FWD	1200 V	30 A	Inverter Diode	
T7	IGBT	1200 V	20 A	Brake Switch	
D7	FWD	1200 V	20 A	Brake Diode	
D8,D9,D10,D11,D12,D13	Rectifier	1600 V	35 A	Rectifier Diode	
NTC	NTC			Thermistor	



Packaging instruction			
Standard packaging quantity (SPQ)	100	>SPQ Standard	<SPQ Sample

Handling instruction
Handling instructions for <i>flow</i> 1 packages see vincotech.com website.

Package data
Package data for <i>flow</i> 1 packages see vincotech.com website.

UL recognition and file number
This device is certified according to UL 1557 standard, UL file number E192116. For more information see vincotech.com website. 

Document No.:	Date:	Modification:	Pages
V23990-P585-x2x-D6-14	29 Nov. 2019	2 clips type added	1, 23

DISCLAIMER
 The information, specifications, procedures, methods and recommendations herein (together "information") are presented by Vincotech to reader in good faith, are believed to be accurate and reliable, but may well be incomplete and/or not applicable to all conditions or situations that may exist or occur. Vincotech reserves the right to make any changes without further notice to any products to improve reliability, function or design. No representation, guarantee or warranty is made to reader as to the accuracy, reliability or completeness of said information or that the application or use of any of the same will avoid hazards, accidents, losses, damages or injury of any kind to persons or property or that the same will not infringe third parties rights or give desired results. It is reader's sole responsibility to test and determine the suitability of the information and the product for reader's intended use.

LIFE SUPPORT POLICY
 Vincotech products are not authorised for use as critical components in life support devices or systems without the express written approval of Vincotech.

As used herein:

1. Life support devices or systems are devices or systems which, (a) are intended for surgical implant into the body, or (b) support or sustain life, or (c) whose failure to perform when properly used in accordance with instructions for use provided in labelling can be reasonably expected to result in significant injury to the user.
2. A critical component is any component of a life support device or system whose failure to perform can be reasonably expected to cause the failure of the life support device or system, or to affect its safety or effectiveness.

单击下面可查看定价，库存，交付和生命周期等信息

[>>Vincotech\(威科\)](#)