

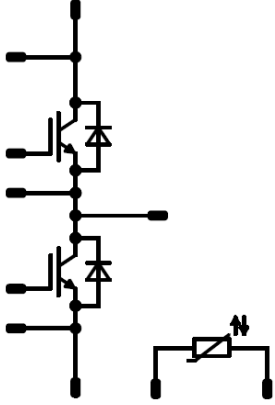

VINcoDUAL E3	1200 V / 600 A
<div style="background-color: #f0f0f0; padding: 2px; margin-bottom: 5px;">Features</div> <ul style="list-style-type: none"> IGBT M7 technology with low V_{CEsat} and improved EMC behavior New SoLid Cover Technology for higher reliability Industry standard housing Press-fit pin and pre-applied phase-change Thermal Interface Material available 	<div style="background-color: #f0f0f0; padding: 2px; margin-bottom: 5px;">VINco E3 housing</div> 
<div style="background-color: #f0f0f0; padding: 2px; margin-bottom: 5px;">Target applications</div> <ul style="list-style-type: none"> Industrial Drives Power Supply UPS 	<div style="background-color: #f0f0f0; padding: 2px; margin-bottom: 5px;">Schematic</div> 
<div style="background-color: #f0f0f0; padding: 2px; margin-bottom: 5px;">Types</div> <ul style="list-style-type: none"> A0-VS122PA600M7-L759F70 A0-VP122PA600M7-L759F70T 	

Maximum Ratings

$T_j = 25\text{ °C}$, unless otherwise specified

Parameter	Symbol	Condition	Value	Unit
Half-Bridge Switch				
Collector-emitter voltage	V_{CES}		1200	V
Collector current	I_C	$T_j = T_{jmax}$ $T_s = 80\text{ °C}$	538	A
Repetitive peak collector current	I_{CRM}	t_p limited by T_{jmax}	1200	A
Total power dissipation	P_{tot}	$T_j = T_{jmax}$ $T_s = 80\text{ °C}$	954	W
Gate-emitter voltage	V_{GES}		±20	V
Short circuit ratings	t_{SC}	$V_{GE} = 15\text{ V}$ $V_{CE} = 800\text{ V}$ $T_j = 150\text{ °C}$	9,5	µs
Maximum junction temperature	T_{jmax}		175	°C



Maximum Ratings

$T_j = 25\text{ °C}$, unless otherwise specified

Parameter	Symbol	Condition	Value	Unit
Half-Bridge Diode				
Peak repetitive reverse voltage	V_{RRM}		1200	V
Continuous (direct) forward current	I_F	$T_j = T_{jmax}$ $T_s = 80\text{ °C}$	437	A
Repetitive peak forward current	I_{FRM}		1200	A
Total power dissipation	P_{tot}	$T_j = T_{jmax}$ $T_s = 80\text{ °C}$	713	W
Maximum junction temperature	T_{jmax}		175	°C

Module Properties

Thermal Properties

Storage temperature	T_{stg}		-40...+125	°C
Operation temperature under switching condition	T_{iop}		-40...($T_{jmax} - 25$)	°C

Isolation Properties

Isolation voltage	V_{isol}	DC Test Voltage* $t_p = 2\text{ s}$	4000	V
		AC Voltage $t_p = 1\text{ min}$	2500	V
Creepage distance			18,1	mm
Clearance			16,2	mm
Comparative Tracking Index	CTI		> 200	

* 100 % tested in production



Characteristic Values

Parameter	Symbol	Conditions					Value			Unit
		V_{GS} [V]	V_{GE} [V]	V_{DS} [V]	I_C [A]	T_j [°C]	Min	Typ	Max	

Half-Bridge Switch

Static

Parameter	Symbol	$V_{GE} = V_{CE}$	V_{GS} [V]	V_{CE} [V]	I_C [A]	T_j [°C]	Min	Typ	Max	Unit
Gate-emitter threshold voltage	$V_{GE(th)}$				0,06	25	5,4	6	6,6	V
Collector-emitter saturation voltage	V_{CEsat}		15		600	25 125 150		1,51 1,71 1,78	2,15	V
Collector-emitter cut-off current*	I_{CES}		0	1200		25			960	μA
Gate-emitter leakage current	I_{GES}		20	0		25			1500	nA
Internal gate resistance	r_g							0,67		Ω
Input capacitance	C_{ies}							111000		pF
Output capacitance	C_{oes}		0	10		25		3300		
Reverse transfer capacitance	C_{res}							1260		
Gate charge	Q_g		15	600	600	25		3600		nC

Thermal

Parameter	Symbol	Material	Min	Typ	Max	Unit
Thermal resistance junction to sink	$R_{th(j-s)}$	phase-change material $\lambda = 3,4$ W/mK				0,10 K/W

Dynamic

Parameter	Symbol	$R_{goff} = 1 \Omega$ $R_{gon} = 1 \Omega$	V_{GS} [V]	V_{CE} [V]	I_C [A]	T_j [°C]	Min	Typ	Max	Unit
Turn-on delay time	$t_{d(on)}$		±15	600	626	25		445		ns
Rise time	t_r					125		461		
Turn-off delay time	$t_{d(off)}$					150		465		
Fall time	t_f					25		68		
Turn-on energy (per pulse)	E_{on}					25		47,602		mWs
Turn-off energy (per pulse)	E_{off}					125		71,722		
						150		79,251		
						25		45,175		
						125		53,576		
						150		60,131		

* including parallel device's leakage current



Vincotech

A0-VS122PA600M7-L759F70
A0-VP122PA600M7-L759F70T
 datasheet

Characteristic Values

Parameter	Symbol	Conditions					Value			Unit
		V_{GE} [V]	V_{CE} [V]	I_C [A]	T_j [°C]	Min	Typ	Max		

Half-Bridge Diode

Static

Parameter	Symbol	V_{GE} [V]	V_{CE} [V]	I_C [A]	T_j [°C]	Min	Typ	Max	Unit
Forward voltage	V_F			600	25 125 150		1,67 1,82 1,83	2,2	V
Reverse leakage current	I_R		1200		25			360	μA

Thermal

Parameter	Symbol	Conditions	Value	Unit
Thermal resistance junction to sink	$R_{th(j-s)}$	phase-change material $\lambda = 3,4$ W/mK	0,13	K/W

Dynamic

Parameter	Symbol	dI/dt	V_{CE}	I_C	T_j	Value	Unit	
Peak recovery current	I_{RRM}				25 125 150	450 476 468	A	
Reverse recovery time	t_{rr}				25 125 150	219 420 466	ns	
Recovered charge	Q_r	$dI/dt = 10500$ A/μs $dI/dt = 8700$ A/μs $dI/dt = 7117$ A/μs	±15	600	626	25 125 150	49,944 85,482 91,410	μC
Reverse recovered energy	E_{rec}				25 125 150	18,159 31,436 33,102	mWs	
Peak rate of fall of recovery current	$(di_r/dt)_{max}$				25 125 150	5046 3591 3605	A/μs	

Thermistor

Parameter	Symbol	Conditions	Value	Unit
Rated resistance	R		25	kΩ
Deviation of R_{100}	$\Delta_{R/R}$	$R_{100} = 493 \Omega$	100	%
Power dissipation	P		25	mW
Power dissipation constant			25	mW/K
B-value	$B_{(25/50)}$	Tol. ±2 %	25	K
B-value	$B_{(25/100)}$	Tol. ±2 %	25	K
Vincotech NTC Reference				K



Half-Bridge Switch Characteristics

figure 1. IGBT

Typical output characteristics

$$I_C = f(V_{CE})$$

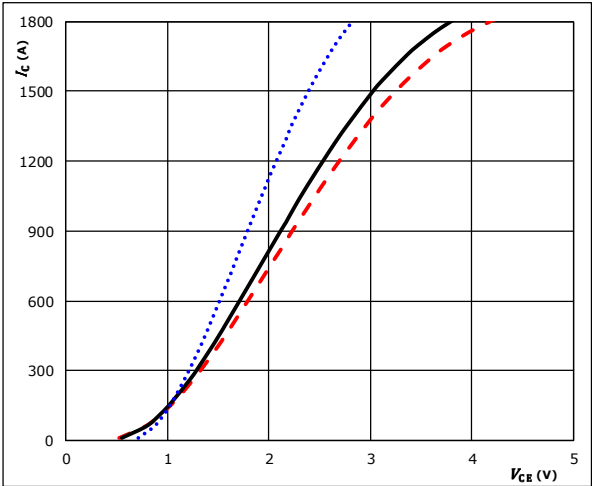

$t_p = 250 \mu s$
 $V_{GE} = 15 V$
 $T_j: 25 \text{ } ^\circ C$ (dotted blue)
 $125 \text{ } ^\circ C$ (solid black)
 $150 \text{ } ^\circ C$ (dashed red)

figure 2. IGBT

Typical output characteristics

$$I_C = f(V_{CE})$$

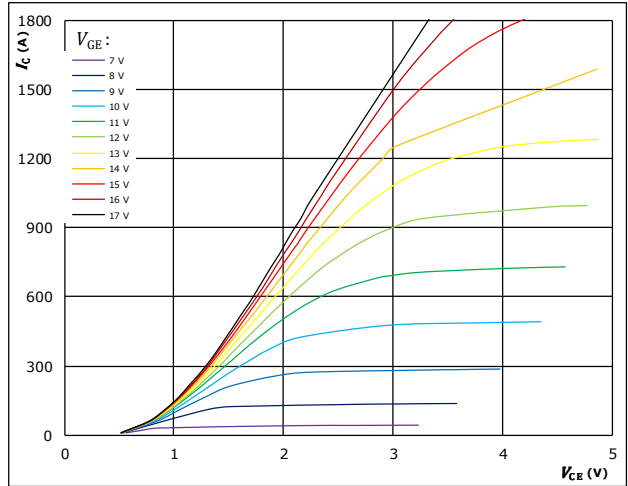

$t_p = 250 \mu s$
 $T_j = 125 \text{ } ^\circ C$
 V_{GE} from 7 V to 17 V in steps of 1 V

figure 3. IGBT

Typical transfer characteristics

$$I_C = f(V_{GE})$$

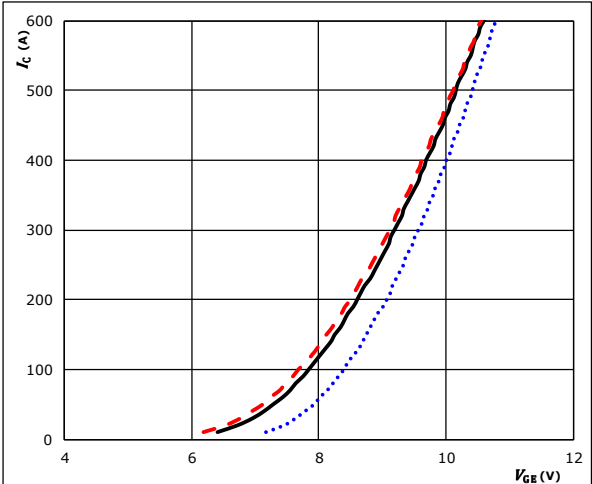

$t_p = 250 \mu s$
 $V_{CE} = 0 V$
 $T_j: 25 \text{ } ^\circ C$ (dotted blue)
 $125 \text{ } ^\circ C$ (solid black)
 $150 \text{ } ^\circ C$ (dashed red)

figure 4. IGBT

Transient thermal impedance as function of pulse duration

$$Z_{th(j-s)} = f(t_p)$$

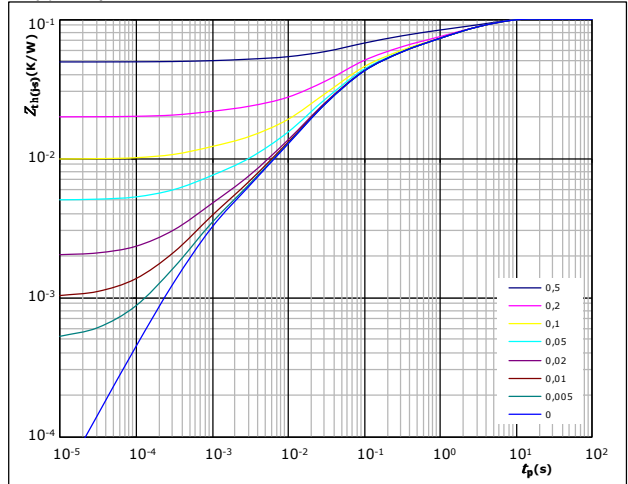

$D = t_p / T$
 $R_{th(j-s)} = 0,10 \text{ K/W}$
 IGBT thermal model values

R (K/W)	τ (s)
3,79E-02	2,69E+00
2,16E-02	3,12E-01
3,06E-02	5,64E-02
6,56E-03	1,08E-02
2,84E-03	8,43E-04



Vincotech

Half-Bridge Switch Characteristics

figure 5. IGBT

Gate voltage vs gate charge

$$V_{GE} = f(Q_G)$$

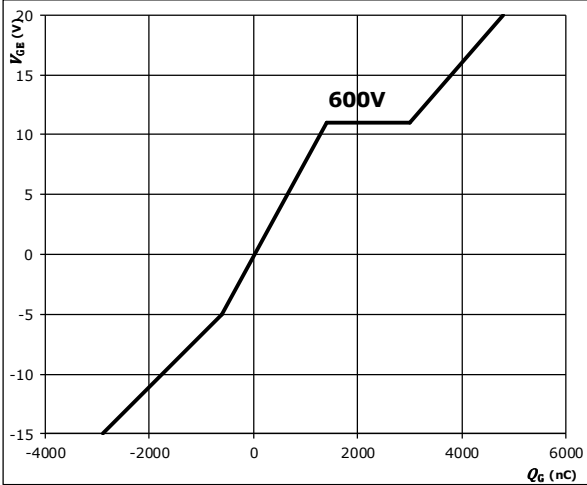

$I_C = 600$ A
 $V_{GE} = \pm 15$ V
 $V_{CC} = 600$ V

figure 6. IGBT

Safe operating area

$$I_C = f(V_{CE})$$

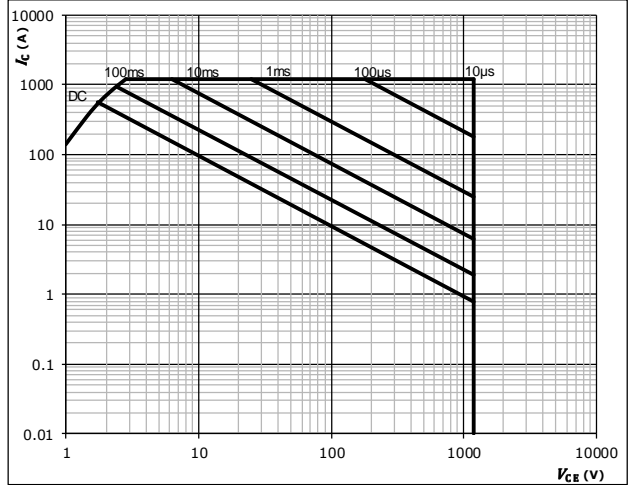

$D =$ single pulse
 $T_s = 80$ °C
 $V_{GE} = \pm 15$ V
 $T_j = T_{jmax}$



Half-Bridge Diode Characteristics

figure 1. FWD

Typical forward characteristics

$$I_F = f(V_F)$$

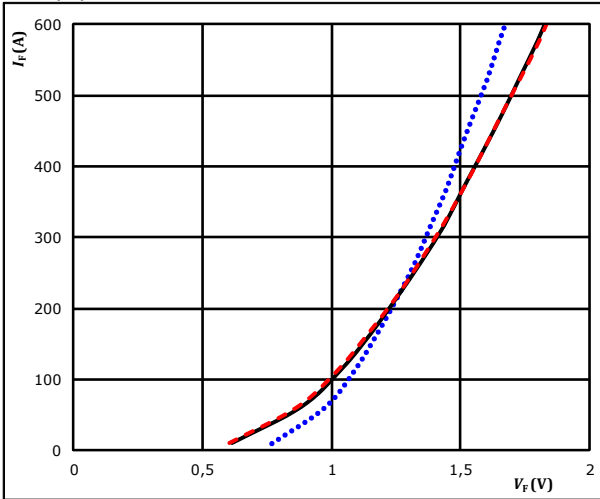

$t_p = 250 \mu s$
 T_j : 25 °C (dotted blue), 125 °C (solid black), 150 °C (dashed red)

figure 2. FWD

Transient thermal impedance as a function of pulse width

$$Z_{th(j-s)} = f(t_p)$$

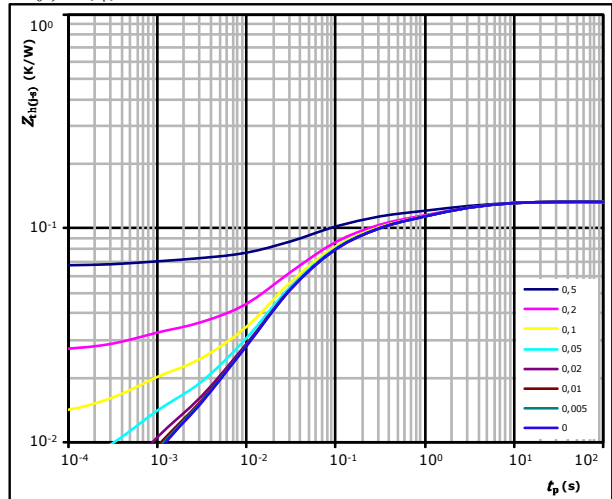

$D = t_p / T$
 $R_{th(j-s)} = 0,13 \text{ K/W}$
 FWD thermal model values

R (K/W)	τ (s)
1,42E-02	4,56E+00
2,24E-02	9,51E-01
3,79E-02	1,30E-01
4,42E-02	3,01E-02
6,69E-03	8,14E-03
7,87E-03	6,10E-04

Thermistor Characteristics

figure 1. Thermistor

Typical NTC characteristic as a function of temperature

$$R = f(T)$$

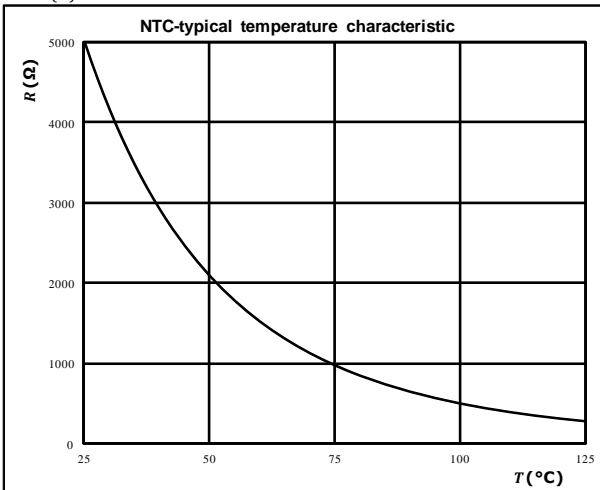



Half-Bridge Switching Characteristics

figure 1. IGBT
 Typical switching energy losses as a function of collector current

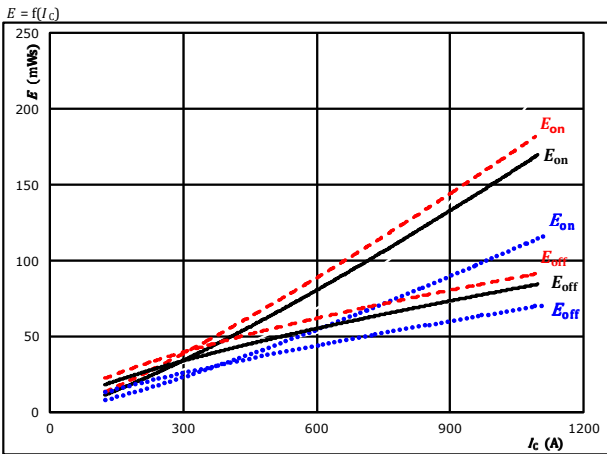

With an inductive load at
 $V_{CE} = 600$ V
 $V_{GE} = \pm 15$ V
 $R_{gon} = 1$ Ω
 $R_{goff} = 1$ Ω

T_j : 25 °C (dotted blue), 125 °C (solid black), 150 °C (dashed red)

figure 2. IGBT
 Typical switching energy losses as a function of gate resistor

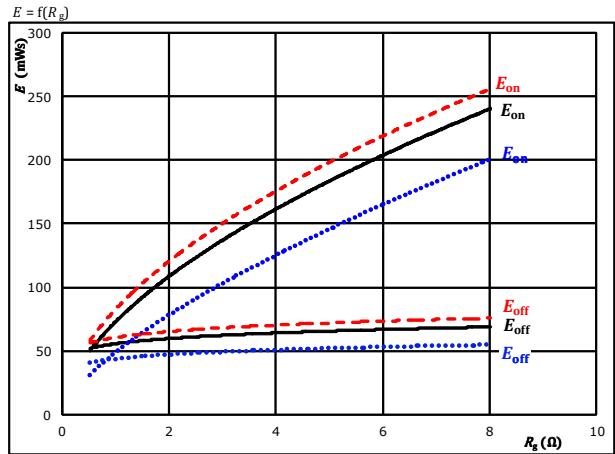

With an inductive load at
 $V_{CE} = 600$ V
 $V_{GE} = \pm 15$ V
 $I_C = 626$ A

T_j : 25 °C (dotted blue), 125 °C (solid black), 150 °C (dashed red)

figure 3. FWD
 Typical reverse recovered energy loss as a function of collector current

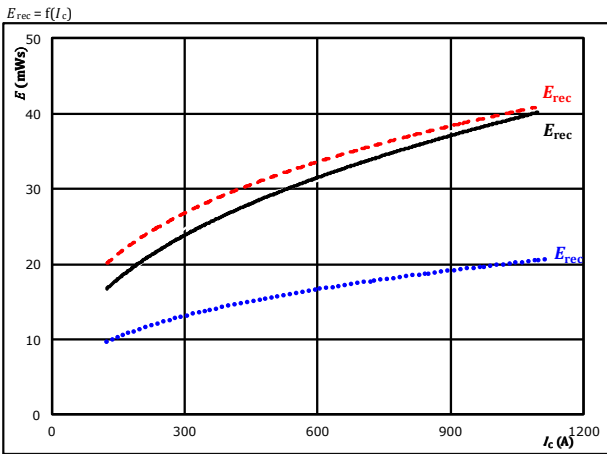

With an inductive load at
 $V_{CE} = 600$ V
 $V_{GE} = \pm 15$ V
 $R_{gon} = 1$ Ω

T_j : 25 °C (dotted blue), 125 °C (solid black), 150 °C (dashed red)

figure 4. FWD
 Typical reverse recovered energy loss as a function of gate resistor

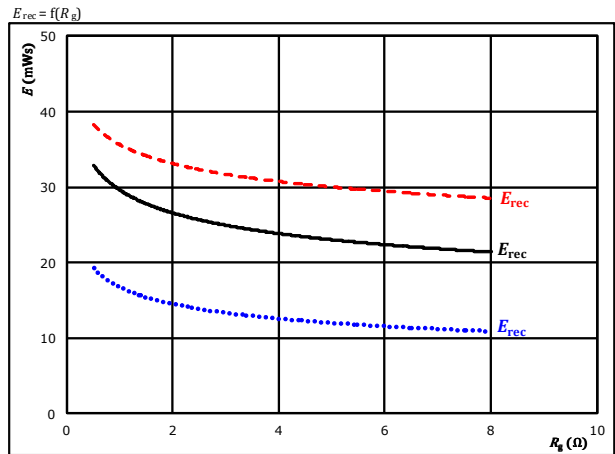

With an inductive load at
 $V_{CE} = 600$ V
 $V_{GE} = \pm 15$ V
 $I_C = 626$ A

T_j : 25 °C (dotted blue), 125 °C (solid black), 150 °C (dashed red)



Vincotech

Half-Bridge Switching Characteristics

figure 5. IGBT

Typical switching times as a function of collector current

$$t = f(I_C)$$

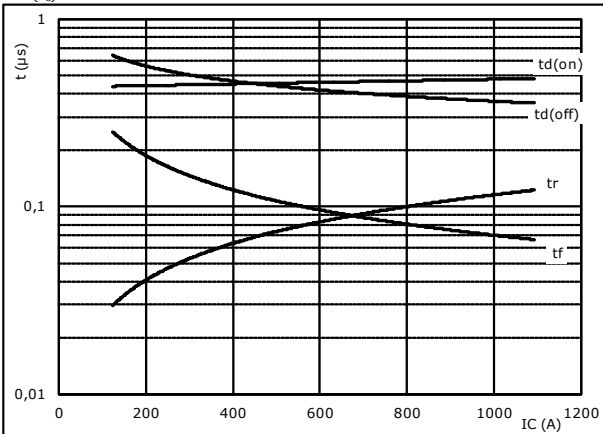

With an inductive load at

$T_j =$	150	°C
$V_{CE} =$	600	V
$V_{GE} =$	±15	V
$R_{gon} =$	1	Ω
$R_{goff} =$	1	Ω

figure 6. IGBT

Typical switching times as a function of gate resistor

$$t = f(R_g)$$

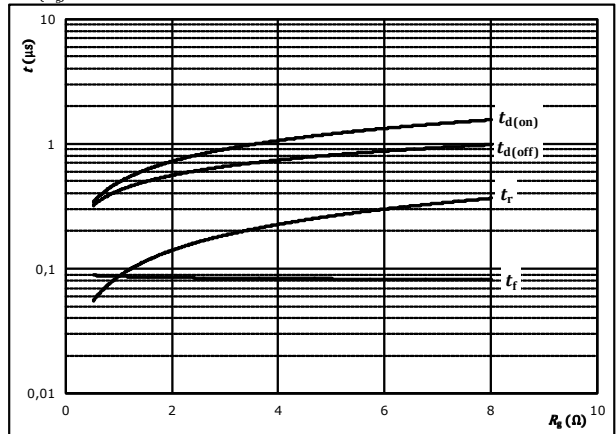

With an inductive load at

$T_j =$	150	°C
$V_{CE} =$	600	V
$V_{GE} =$	±15	V
$I_C =$	626	A

figure 7. FWD

Typical reverse recovery time as a function of collector current

$$t_{rr} = f(I_C)$$

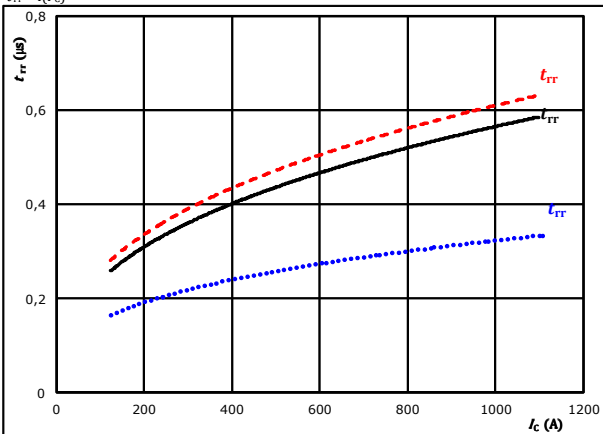

At	$V_{CE} =$	600	V	$T_j:$	25 °C
	$V_{GE} =$	±15	V		125 °C	————
	$R_{gon} =$	1	Ω		150 °C	-----

figure 8. FWD

Typical reverse recovery time as a function of IGBT turn on gate resistor

$$t_{rr} = f(R_{gon})$$

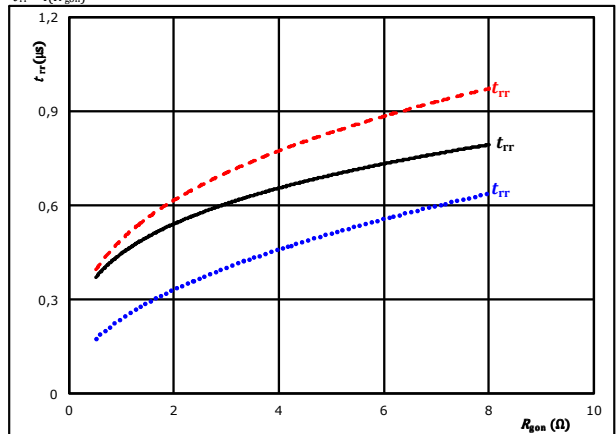

At	$V_{CE} =$	600	V	$T_j:$	25 °C
	$V_{GE} =$	±15	V		125 °C	————
	$I_C =$	626	A		150 °C	-----



Half-Bridge Switching Characteristics

figure 9. FWD

Typical recovered charge as a function of collector current

$$Q_r = f(I_c)$$

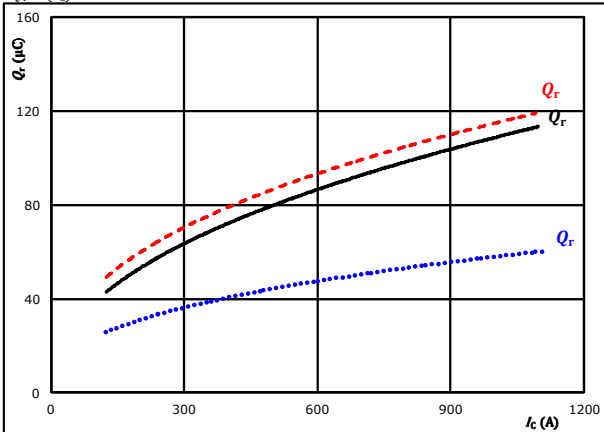

At $V_{CE} = 600$ V
 $V_{GE} = \pm 15$ V
 $R_{gpn} = 1$ Ω
 $T_j: 25$ °C (dotted blue)
 125 °C (solid black)
 150 °C (dashed red)

figure 10. FWD

Typical recovered charge as a function of IGBT turn on gate resistor

$$Q_r = f(R_{gpn})$$

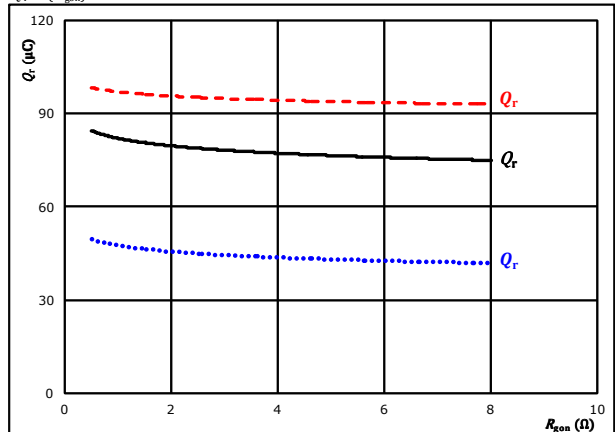

At $V_{CE} = 600$ V
 $V_{GE} = \pm 15$ V
 $I_c = 626$ A
 $T_j: 25$ °C (dotted blue)
 125 °C (solid black)
 150 °C (dashed red)

figure 11. FWD

Typical peak reverse recovery current as a function of collector current

$$I_{RM} = f(I_c)$$

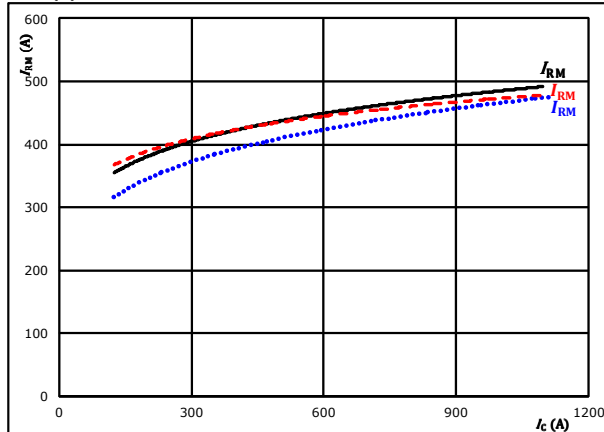

At $V_{CE} = 600$ V
 $V_{GE} = \pm 15$ V
 $R_{gpn} = 1$ Ω
 $T_j: 25$ °C (dotted blue)
 125 °C (solid black)
 150 °C (dashed red)

figure 12. FWD

Typical peak reverse recovery current as a function of IGBT turn on gate resistor

$$I_{RM} = f(R_{gpn})$$

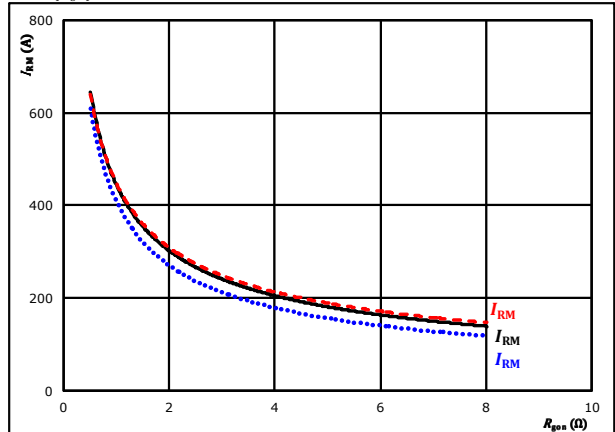

At $V_{CE} = 600$ V
 $V_{GE} = \pm 15$ V
 $I_c = 626$ A
 $T_j: 25$ °C (dotted blue)
 125 °C (solid black)
 150 °C (dashed red)



Vincotech

Half-Bridge Switching Characteristics

figure 13. FWD

Typical rate of fall of forward and reverse recovery current as a function of collector current
 $di_f/dt, di_{rr}/dt = f(I_c)$

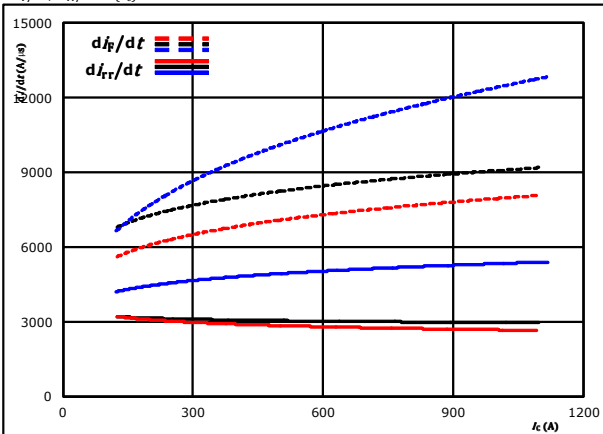

At $V_{CE} = 600$ V $T_j = 25$ °C (blue dotted line)
 $V_{GE} = \pm 15$ V $T_j = 125$ °C (black solid line)
 $R_{gpn} = 1$ Ω $T_j = 150$ °C (red dashed line)

figure 14. FWD

Typical rate of fall of forward and reverse recovery current as a function of IGBT turn on gate resistor
 $di_f/dt, di_{rr}/dt = f(R_{gon})$

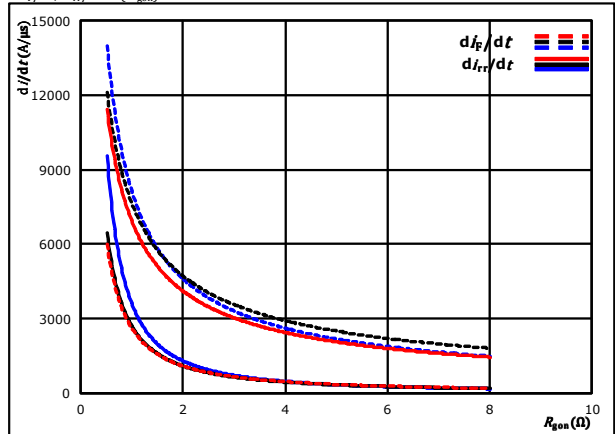

At $V_{CE} = 600$ V $T_j = 25$ °C (blue dotted line)
 $V_{GE} = \pm 15$ V $T_j = 125$ °C (black solid line)
 $I_c = 626$ A $T_j = 150$ °C (red dashed line)

figure 15. IGBT

Reverse bias safe operating area

$I_c = f(V_{CE})$

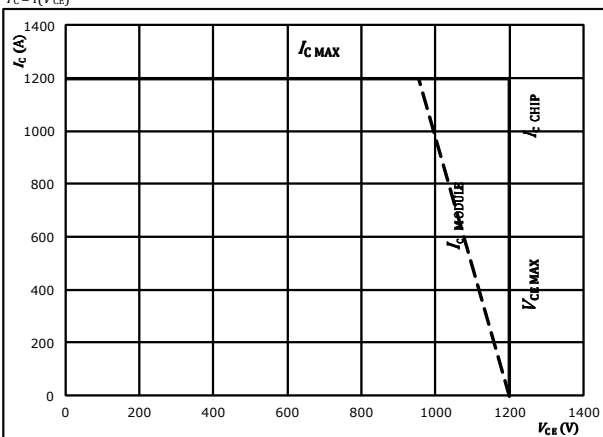

At $T_j = 175$ °C
 $R_{gpn} = 1$ Ω
 $R_{goff} = 1$ Ω



Vincotech

Half-Bridge Switching Characteristics

General conditions

T_j	=	125 °C
R_{gon}	=	1 Ω
R_{goff}	=	1 Ω

figure 1. IGBT

Turn-off Switching Waveforms & definition of t_{doff} , t_{Eoff} (t_{Eoff} = integrating time for Eoff)

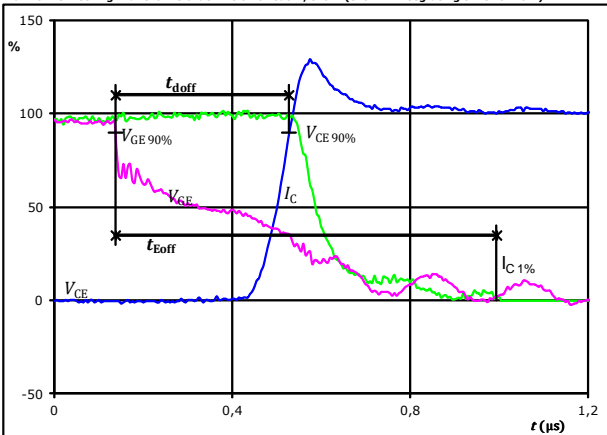

$V_{GE}(0\%) =$	-15	V
$V_{GE}(100\%) =$	15	V
$V_C(100\%) =$	600	V
$I_C(100\%) =$	617	A
$t_{doff} =$	0,393	μs
$t_{Eoff} =$	0,858	μs

figure 2. IGBT

Turn-on Switching Waveforms & definition of t_{don} , t_{Eon} (t_{Eon} = integrating time for Eon)

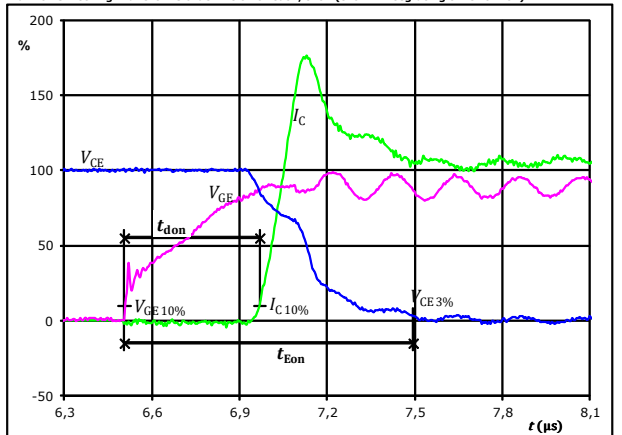

$V_{GE}(0\%) =$	-15	V
$V_{GE}(100\%) =$	15	V
$V_C(100\%) =$	600	V
$I_C(100\%) =$	617	A
$t_{don} =$	0,461	μs
$t_{Eon} =$	0,989	μs

figure 3. IGBT

Turn-off Switching Waveforms & definition of t_f

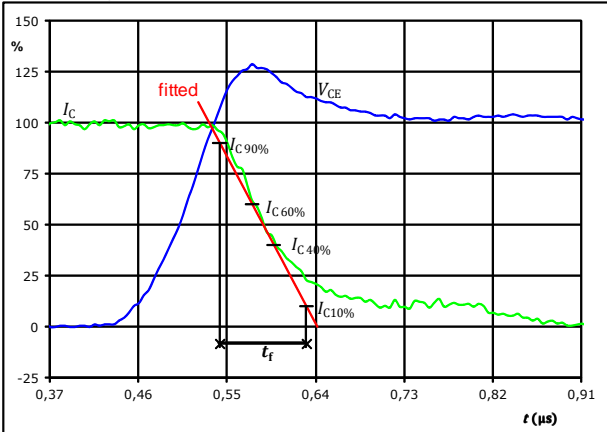

$V_C(100\%) =$	600	V
$I_C(100\%) =$	617	A
$t_f =$	0,082	μs

figure 4. IGBT

Turn-on Switching Waveforms & definition of t_r

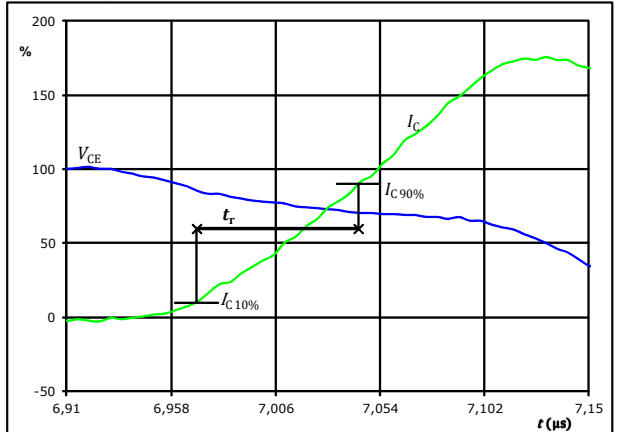

$V_C(100\%) =$	600	V
$I_C(100\%) =$	617	A
$t_r =$	0,074	μs



Vincotech

Half-Bridge Switching Characteristics

figure 5. IGBT

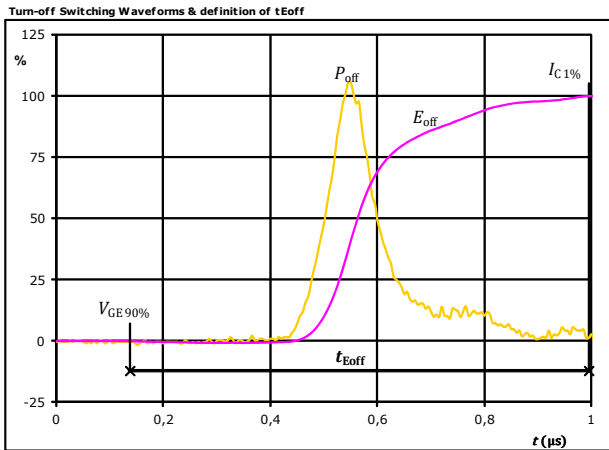

$P_{off}(100\%) = 370,46$ kW
 $E_{off}(100\%) = 53,58$ mJ
 $t_{Eoff} = 0,86$ µs

figure 6. IGBT

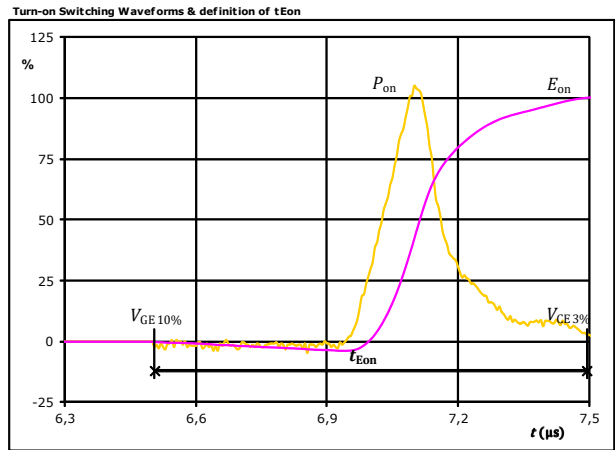

$P_{on}(100\%) = 370,46$ kW
 $E_{on}(100\%) = 71,72$ mJ
 $t_{Eon} = 0,99$ µs

figure 7. FWD

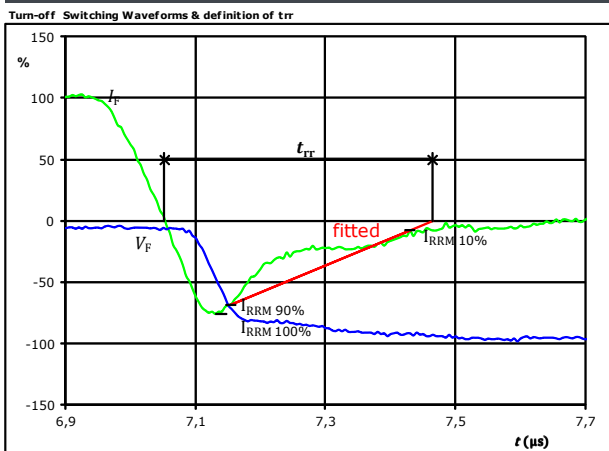

$V_F(100\%) = 600$ V
 $I_F(100\%) = 617$ A
 $I_{RRM}(100\%) = -476$ A
 $t_{rr} = 0,420$ µs



Vincotech

A0-VS122PA600M7-L759F70
A0-VP122PA600M7-L759F70T
 datasheet

Half-Bridge Switching Characteristics

figure 8. FWD

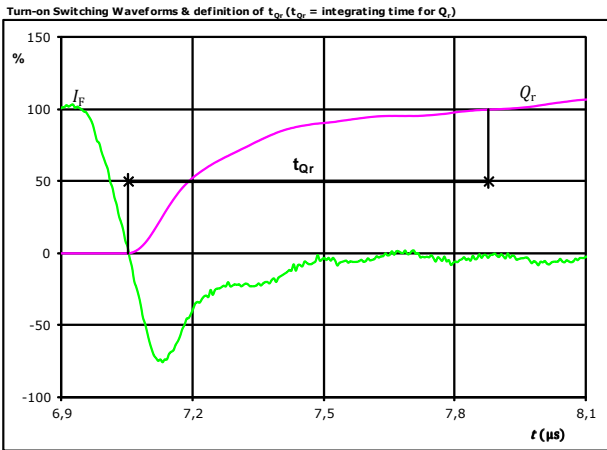

I_F (100%) =	617	A
Q_r (100%) =	85,50	μC
t_{Qr} =	0,82	μs

figure 9. FWD

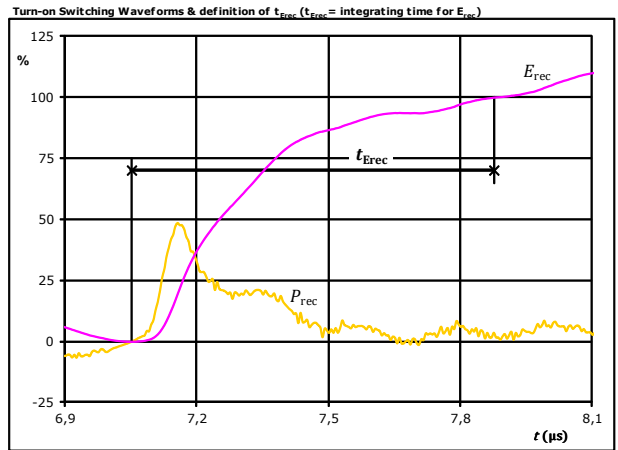

P_{rec} (100%) =	370,46	kW
E_{rec} (100%) =	31,45	mJ
t_{Erec} =	0,82	μs



A0-VS122PA600M7-L759F70
A0-VP122PA600M7-L759F70T
 datasheet

Vincotech

Ordering Code & Marking							
Version			Ordering Code				
without thermal paste 17 mm housing with solder pins			A0-VS122PA600M7-L759F70				
with thermal paste 17 mm housing with solder pins			A0-VS122PA600M7-L759F70- /3/				
without thermal paste 17 mm housing with Press-fit pins			A0-VP122PA600M7-L759F70T				
with thermal paste 17 mm housing with Press-fit pins			A0-VP122PA600M7-L759F70T- /3/				
NN-NNNNNNNNNNNN-TTTTTWW VIN WWYY LLLLL SSSS		Text	Name	Date code	UL & VIN	Lot	Serial
			NN-NNNNNNNNNNNN-TTTTTWW TTTTTTWW LLLLL SSSS	WWYY	UL VIN	LLLLL	SSSS
			Datamatrix	Type&Ver	Lot number	Serial	Date code
			TTTTTWW	LLLLL	SSSS	WWYY	

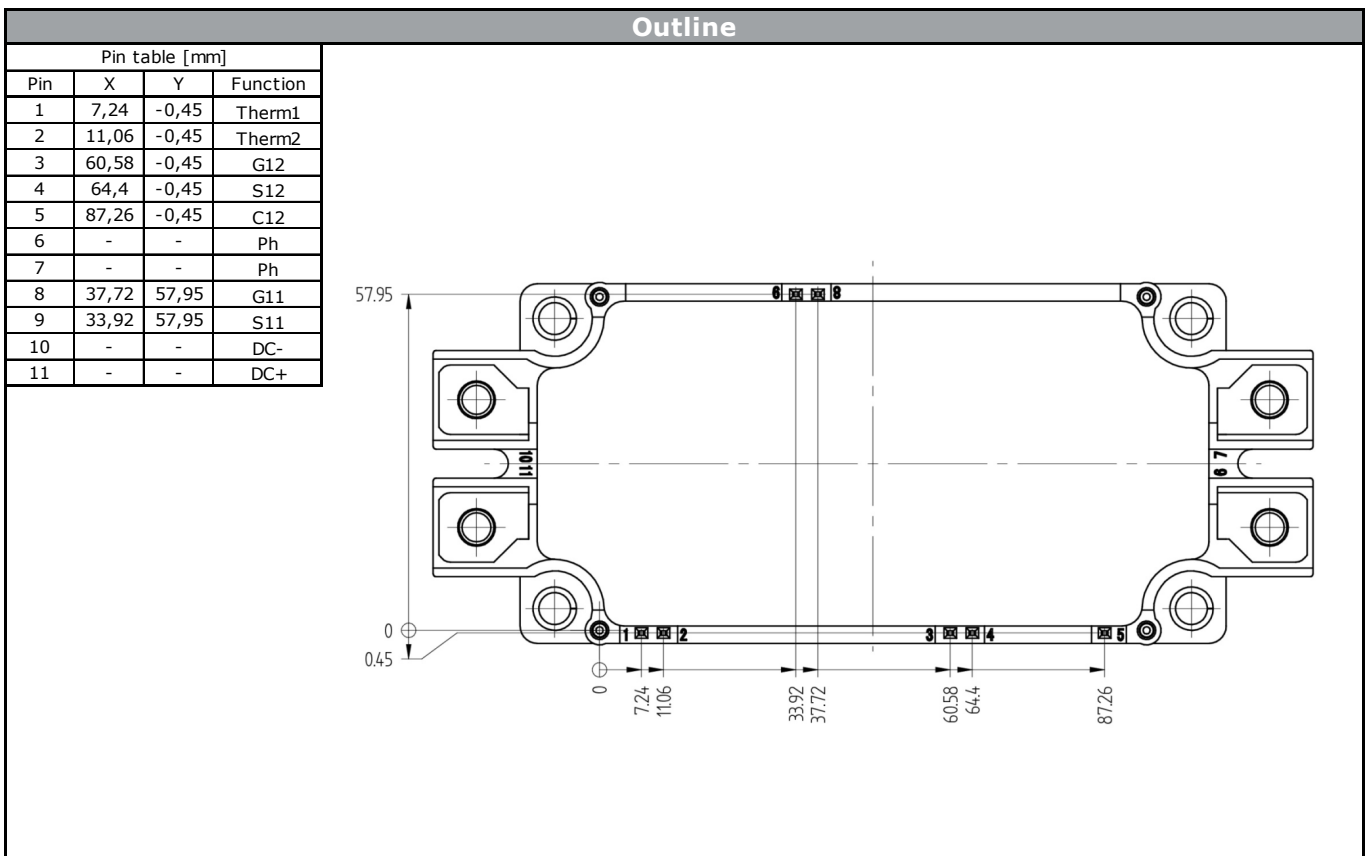



Vincotech

A0-VS122PA600M7-L759F70
A0-VP122PA600M7-L759F70T
 datasheet

Pinout

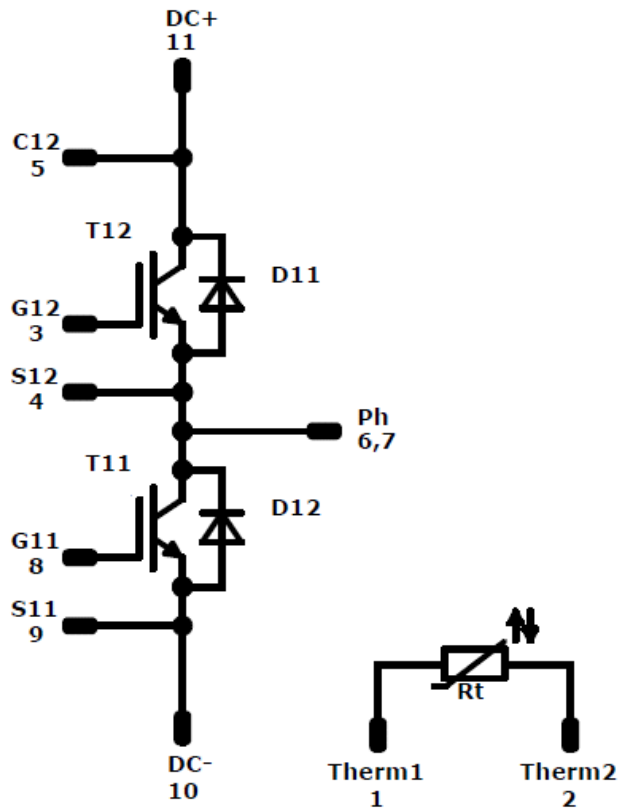

Identification

ID	Component	Voltage	Current	Function	Comment
T11,T12	IGBT	1200 V	600 A	Half-Bridge Switch	
D11,D12	FWD	1200 V	600 A	Half-Bridge Diode	
Rt	NTC			Thermistor	



Vincotech

A0-VS122PA600M7-L759F70
A0-VP122PA600M7-L759F70T
datasheet

Packaging instruction			
Standard packaging quantity (SPQ) 24	>SPQ	Standard	<SPQ Sample

Handling instruction
Handling instructions for VINco E3 packages see vincotech.com website.

Package data
Package data for VINco E3 packages see vincotech.com website.

UL recognition and file number
This device is certified according to UL 1557 standard, UL file number E192116. For more information see vincotech.com website. 

Document No.:	Date:	Modification:	Pages
A0-Vx122PA600M7-L759F70x-D5-14	24 Sep. 2019	Change of Zth curves Short circuit ratings added	1, 5 1, 6

DISCLAIMER

The information, specifications, procedures, methods and recommendations herein (together "information") are presented by Vincotech to reader in good faith, are believed to be accurate and reliable, but may well be incomplete and/or not applicable to all conditions or situations that may exist or occur. Vincotech reserves the right to make any changes without further notice to any products to improve reliability, function or design. No representation, guarantee or warranty is made to reader as to the accuracy, reliability or completeness of said information or that the application or use of any of the same will avoid hazards, accidents, losses, damages or injury of any kind to persons or property or that the same will not infringe third parties rights or give desired results. It is reader's sole responsibility to test and determine the suitability of the information and the product for reader's intended use.

LIFE SUPPORT POLICY

Vincotech products are not authorised for use as critical components in life support devices or systems without the express written approval of Vincotech.

As used herein:

1. Life support devices or systems are devices or systems which, (a) are intended for surgical implant into the body, or (b) support or sustain life, or (c) whose failure to perform when properly used in accordance with instructions for use provided in labelling can be reasonably expected to result in significant injury to the user.
2. A critical component is any component of a life support device or system whose failure to perform can be reasonably expected to cause the failure of the life support device or system, or to affect its safety or effectiveness.

单击下面可查看定价，库存，交付和生命周期等信息

[>>Vincotech\(威科\)](#)