



<i>flow</i> PIM 1	1200 V / 35 A
<div style="border: 1px solid black; padding: 5px; margin-bottom: 5px;"> <p style="text-align: center; margin: 0;"><b>Features</b></p> <ul style="list-style-type: none"> <li>Three-phase rectifier, optional BRC, Inverter, NTC</li> <li>Very compact housing, easy to route</li> <li>IGBT4 / EmCon4 technology for low saturation losses and improved EMC behaviour</li> </ul> </div> <div style="border: 1px solid black; padding: 5px; margin-bottom: 5px;"> <p style="text-align: center; margin: 0;"><b>Target Applications</b></p> <ul style="list-style-type: none"> <li>Industrial drives</li> <li>Embedded drives</li> </ul> </div> <div style="border: 1px solid black; padding: 5px;"> <p style="text-align: center; margin: 0;"><b>Types</b></p> <ul style="list-style-type: none"> <li>V23990-P580-A41-PM</li> <li>V23990-P580-A41Y-PM</li> <li>V23990-P580-A418-PM</li> <li>V23990-P580-A418Y-PM</li> <li>V23990-P580-C41-PM</li> <li>V23990-P580-C41Y-PM</li> <li>V23990-P580-C418-PM</li> </ul> </div>	<div style="border: 1px solid black; padding: 5px; margin-bottom: 5px;"> <p style="text-align: center; margin: 0;"><i>flow</i> 1 housing</p> <p style="margin: 0;">17 mm housing Press-fit pin / Solder pin</p> <p style="margin: 0;">12 mm housing Press-fit pin / Solder pin</p> </div> <div style="border: 1px solid black; padding: 5px;"> <p style="text-align: center; margin: 0;"><b>Schematic</b></p> </div>

## Maximum Ratings

$T_j = 25\text{ °C}$ , unless otherwise specified

Parameter	Symbol	Condition	Value	Unit
<b>Rectifier Diode</b>				
Repetitive peak reverse voltage	$V_{RRM}$		1600	V
DC forward current	$I_{FAV}$		35	A
Surge (non-repetitive) forward current	$I_{FSM}$	$t_p = 10\text{ ms}$	280	A
$I^2t$ -value	$I^2t$	50Hz half sine wave	390	A <sup>2</sup> s
Power dissipation	$P_{tot}$	$T_j = T_{jmax}$ $T_s = 80\text{ °C}$	56	W
Maximum Junction Temperature	$T_{jmax}$		150	°C
<b>Inverter Switch</b>				
Collector-emitter breakdown voltage	$V_{CE}$		1200	V
DC collector current	$I_C$		35	A
Repetitive peak collector current	$I_{CRM}$	$t_p$ limited by $T_{jmax}$	105	A
Turn off safe operating area		$V_{CE} \leq 1200\text{ V}$ , $T_j \leq T_{op\ max}$	105	A
Power dissipation	$P_{tot}$	$T_j = T_{jmax}$ $T_s = 80\text{ °C}$	114	W
Gate-emitter peak voltage	$V_{GE}$		±20	V
Short circuit ratings	$t_{SC}$ $V_{CC}$	$T_j \leq 150\text{ °C}$ $V_{GE} = 15\text{ V}$	10 800	µs V
Maximum Junction Temperature	$T_{jmax}$		175	°C

**Maximum Ratings** $T_j = 25\text{ °C}$ , unless otherwise specified

Parameter	Symbol	Condition	Value	Unit
-----------	--------	-----------	-------	------

**Inverter Diode**

Peak Repetitive Reverse Voltage	$V_{RRM}$		1200	V
DC forward current	$I_F$		35	A
Repetitive peak forward current	$I_{FRM}$	$t_p$ limited by $T_{jmax}$	70	A
Power dissipation	$P_{tot}$	$T_j = T_{jmax}$ $T_s = 80\text{ °C}$	80	W
Maximum Junction Temperature	$T_{jmax}$		175	°C

**Brake Switch**

Collector-emitter breakdown voltage	$V_{CE}$		1200	V
DC collector current	$I_C$		25	A
Repetitive peak collector current	$I_{CRM}$	$t_p$ limited by $T_{jmax}$	75	A
Turn off safe operating area		$V_{CE} \leq 1200V, T_j \leq T_{op\ max}$	50	A
Power dissipation	$P_{tot}$	$T_j = T_{jmax}$ $T_s = 80\text{ °C}$	94	W
Gate-emitter peak voltage	$V_{GE}$		$\pm 20$	V
Short circuit ratings	$t_{SC}$ $V_{CC}$	$T_j \leq 150\text{ °C}$ $V_{GE} = 15\text{ V}$	10 800	$\mu s$ V
Maximum Junction Temperature	$T_{jmax}$		175	°C

**Brake Diode**

Peak Repetitive Reverse Voltage	$V_{RRM}$		1200	V
DC forward current	$I_F$		10	A
Repetitive peak forward current	$I_{FRM}$	$t_p$ limited by $T_{jmax}$	20	A
Power dissipation	$P_{tot}$	$T_j = T_{jmax}$ $T_s = 80\text{ °C}$	46	W
Maximum Junction Temperature	$T_{jmax}$		175	°C

**Thermal Properties**

Storage temperature	$T_{stg}$		-40...+125	°C
Operation temperature under switching condition	$T_{op}$		-40...+( $T_{jmax} - 25$ )	°C

**Isolation Properties**

Isolation voltage	$V_{is}$	$t = 2\text{ s}$ DC Voltage*	6000	V
		$t = 1\text{ min}$ AC Voltage	2500	V
Creepage distance			min 12,7	mm
Clearance		12 mm housing solder pin / press-fit pin	7,91 / 7,96	mm
		17 mm housing	min 12,7	mm
Comparative tracking index	CTI		>200	

\* 100 % tested in production



### Characteristic Values

Parameter	Symbol	Conditions					Value			Unit	
		$V_{GE}$ [V]	$V_{GS}$ [V]	$V_r$ [V]	$V_{CE}$ [V]	$V_{DS}$ [V]	$I_C$ [A]	$I_F$ [A]	$I_D$ [A]		$T_j$ [°C]

#### Rectifier Diode

Forward voltage	$V_F$					30	25 125	0,8	1,16 1,13	1,6	V
Threshold voltage (for power loss calc. only)	$V_{to}$						25 125		0,90 0,78		V
Slope resistance (for power loss calc. only)	$r_t$						25 125		8 11		mΩ
Reverse current	$I_r$			1600			25 150			0,02 2	mA
Thermal resistance junction to sink	$R_{th(j-s)}$	$\lambda_{paste} = 3,4$ W/mK (PSX)							1,25		K/W

#### Inverter Switch

Gate emitter threshold voltage	$V_{GE(th)}$	$V_{CE} = V_{GE}$				0,0012	25	5	5,8	6,5	V
Collector-emitter saturation voltage	$V_{CEsat}$		15			35	25 125	1,6	1,95 2,39	2,3	V
Collector-emitter cut-off current incl. Diode	$I_{CES}$		0	1200			25			0,5	mA
Gate-emitter leakage current	$I_{GES}$		20	0			25			300	nA
Integrated Gate resistor	$R_{gint}$								none		Ω
Turn-on delay time	$t_{d(on)}$	$R_{gon} = 16$ Ω $R_{goff} = 16$ Ω	±15	600	35		25		92		ns
Rise time	$t_r$						125		92		
Turn-off delay time	$t_{d(off)}$						25		18		
Fall time	$t_f$						125		23		
Turn-on energy loss	$E_{on}$						25		213		
Turn-off energy loss	$E_{off}$	125	274								
Input capacitance	$C_{ies}$	$f = 1$ MHz	0	25		25			1950		pF
Output capacitance	$C_{oss}$								155		
Reverse transfer capacitance	$C_{rss}$								115		
Thermal resistance junction to sink	$R_{th(j-s)}$	$\lambda_{paste} = 3,4$ W/mK (PSX)							0,83		K/W

#### Inverter Diode

Diode forward voltage	$V_F$					35	25 125	1	1,83 1,80	2,2	V
Peak reverse recovery current	$I_{RRM}$	$R_{gon} = 16$ Ω	±15	600	35		25		69		A
Reverse recovery time	$t_{rr}$						125		79		
Reverse recovered charge	$Q_{rr}$						25		150		
Peak rate of fall of recovery current	$(di_{rr}/dt)_{max}$						125		277		
Reverse recovered energy	$E_{rec}$						25		3,93		
Thermal resistance junction to sink	$R_{th(j-s)}$	$\lambda_{paste} = 3,4$ W/mK (PSX)							1,19		K/W



### Characteristic Values

Parameter	Symbol	Conditions					Value			Unit	
		$V_{GE}$ [V]	$V_{GS}$ [V]	$V_r$ [V]	$V_{CE}$ [V]	$V_{DS}$ [V]	$I_C$ [A]	$I_F$ [A]	$I_D$ [A]		$T_j$ [°C]

#### Brake Switch

Gate emitter threshold voltage	$V_{GE(th)}$	$V_{CE} = V_{GE}$				0,00085	25		5	5,8	6,5	V
Collector-emitter saturation voltage	$V_{CE(sat)}$		15			25	25 125		1,6	1,86 2,31	2,2	V
Collector-emitter cut-off incl diode	$I_{CES}$		0	1200			25				0,005	mA
Gate-emitter leakage current	$I_{GES}$		20	0			25				200	nA
Integrated Gate resistor	$R_{gint}$									none		Ω
Turn-on delay time	$t_{d(on)}$						25 125			127 129		ns
Rise time	$t_r$						25 125			36 42		
Turn-off delay time	$t_{d(off)}$	$R_{goff} = 32 \Omega$ $R_{gon} = 32 \Omega$	15	600	25		25 125			232 276		
Fall time	$t_f$						25 125			74 112		
Turn-on energy loss	$E_{on}$						25 125			1,81 2,42		mWs
Turn-off energy loss	$E_{off}$						25 125			1,37 2,19		
Input capacitance	$C_{ies}$									1430		pF
Output capacitance	$C_{oss}$	$f = 1 \text{ MHz}$	0	25		25				115		
Reverse transfer capacitance	$C_{rss}$									85		
Gate charge	$Q_G$		15	960	25	25				120		nC
Thermal resistance junction to sink	$R_{th(j-s)}$	$\lambda_{paste} = 3,4 \text{ W/mK (PSX)}$								1,01		K/W

#### Brake Diode

Diode forward voltage	$V_F$					10	25 125		1,35	1,85 1,76	2,05	V
Reverse leakage current	$I_r$			1200			25				2,7	μA
Peak reverse recovery current	$I_{RRM}$						25 125			10 12		A
Reverse recovery time	$t_{rr}$						25 125			396 624		ns
Reverse recovered charge	$Q_{rr}$	$R_{gon} = 32 \Omega$	15	600	25		25 125			1,55 3,03		μC
Peak rate of fall of recovery current	$(di_{rr}/dt)_{max}$						25 125			36 32		A/μs
Reverse recovery energy	$E_{rec}$						25 125			0,63 1,30		mWs
Thermal resistance junction to sink	$R_{th(j-s)}$	$\lambda_{paste} = 3,4 \text{ W/mK (PSX)}$								2,07		K/W

#### Thermistor

Rated resistance	$R$						25			22000		Ω
Deviation of $R_{100}$	$\Delta_{R/R}$						25		-5		5	%
Power dissipation	$P$						25			200		mW
Power dissipation constant							25			2		mW/K
B-value	$B_{(25/50)}$	Tol. ±3%					25			3950		K
B-value	$B_{(25/100)}$						25			3996		K
Vincotech NTC Reference											B	



### Inverter Characteristics

**figure 1. IGBT**

**Typical output characteristics**

$I_C = f(V_{CE})$

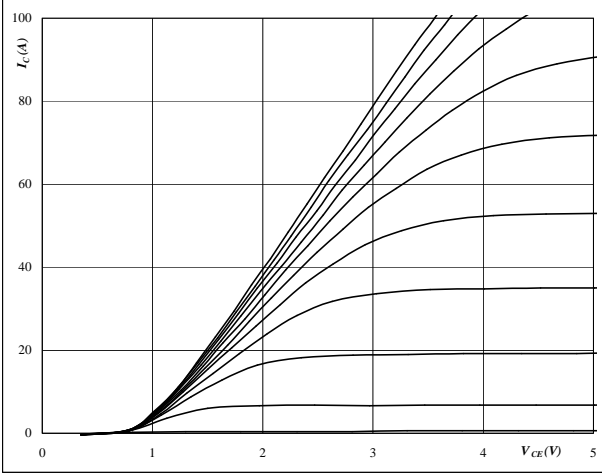

**At**  
 $t_p = 250 \mu s$   
 $T_j = 25 \text{ }^\circ C$   
 $V_{GE}$  from 7 V to 17 V in steps of 1 V

**figure 2. IGBT**

**Typical output characteristics**

$I_C = f(V_{CE})$

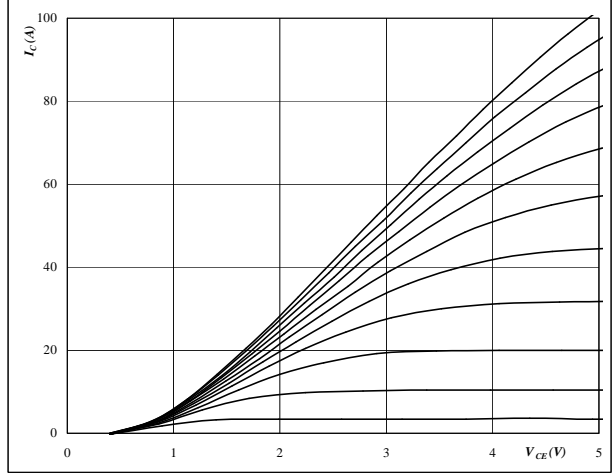

**At**  
 $t_p = 250 \mu s$   
 $T_j = 150 \text{ }^\circ C$   
 $V_{GE}$  from 7 V to 17 V in steps of 1 V

**figure 3. IGBT**

**Typical transfer characteristics**

$I_C = f(V_{GE})$

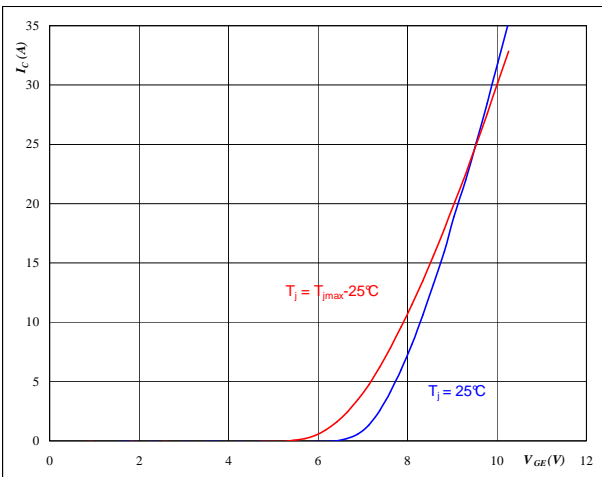

**At**  
 $t_p = 250 \mu s$   
 $V_{CE} = 10 V$

**figure 4. FWD**

**Typical diode forward current as a function of forward voltage**

$I_F = f(V_F)$

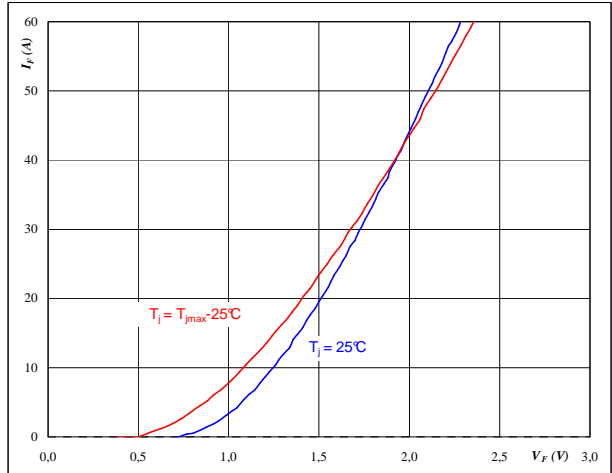

**At**  
 $t_p = 250 \mu s$



# Inverter Characteristics

**figure 5.** IGBT

**Typical switching energy losses as a function of collector current**

$E = f(I_c)$

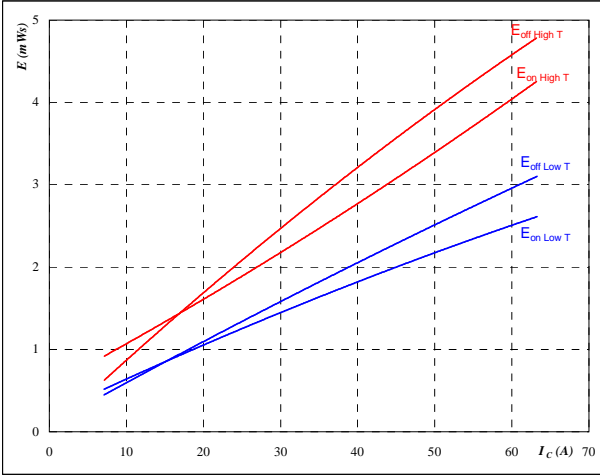

With an inductive load at

- $T_j = 25/150$  °C
- $V_{CE} = 600$  V
- $V_{GE} = \pm 15$  V
- $R_{gon} = 16$  Ω
- $R_{goff} = 16$  Ω

**figure 6.** IGBT

**Typical switching energy losses as a function of gate resistor**

$E = f(R_g)$

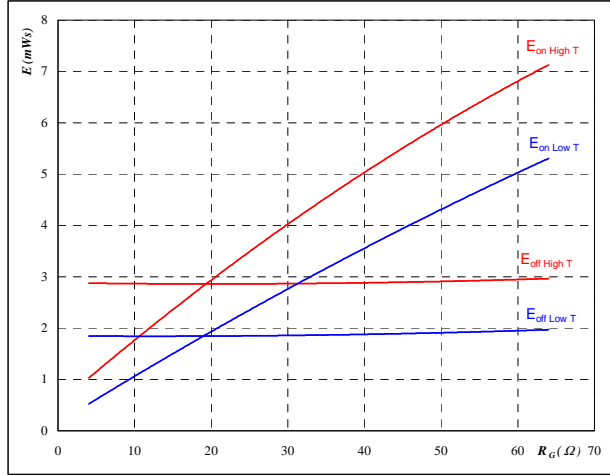

With an inductive load at

- $T_j = 25/150$  °C
- $V_{CE} = 600$  V
- $V_{GE} = \pm 15$  V
- $I_c = 35$  A

**figure 7.** FWD

**Typical reverse recovery energy loss as a function of collector current**

$E_{rec} = f(I_c)$

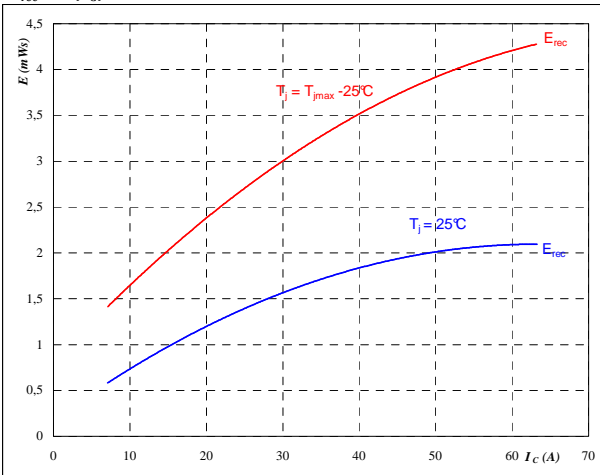

With an inductive load at

- $T_j = 25/150$  °C
- $V_{CE} = 600$  V
- $V_{GE} = \pm 15$  V
- $R_{gon} = 16$  Ω

**figure 8.** FWD

**Typical reverse recovery energy loss as a function of gate resistor**

$E_{rec} = f(R_g)$

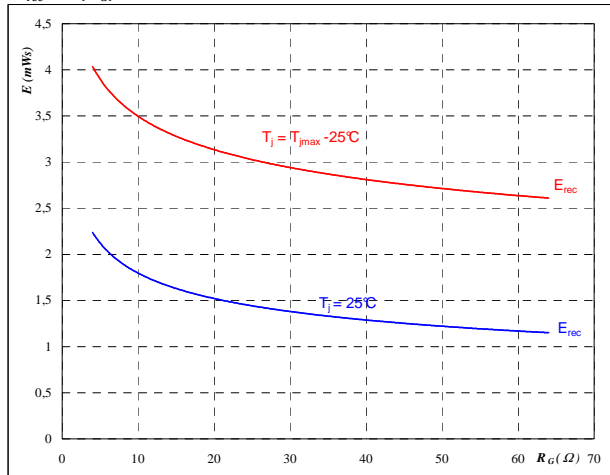

With an inductive load at

- $T_j = 25/150$  °C
- $V_{CE} = 600$  V
- $V_{GE} = \pm 15$  V
- $I_c = 35$  A



### Inverter Characteristics

**figure 9. IGBT**

**Typical switching times as a function of collector current**  
 $t = f(I_C)$

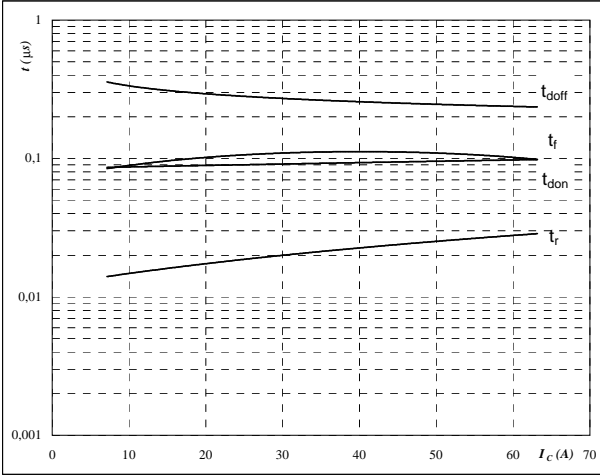

With an inductive load at  
 $T_j = 150 \text{ } ^\circ\text{C}$   
 $V_{CE} = 600 \text{ V}$   
 $V_{GE} = \pm 15 \text{ V}$   
 $R_{gon} = 16 \text{ } \Omega$   
 $R_{goff} = 16 \text{ } \Omega$

**figure 10. IGBT**

**Typical switching times as a function of gate resistor**  
 $t = f(R_G)$

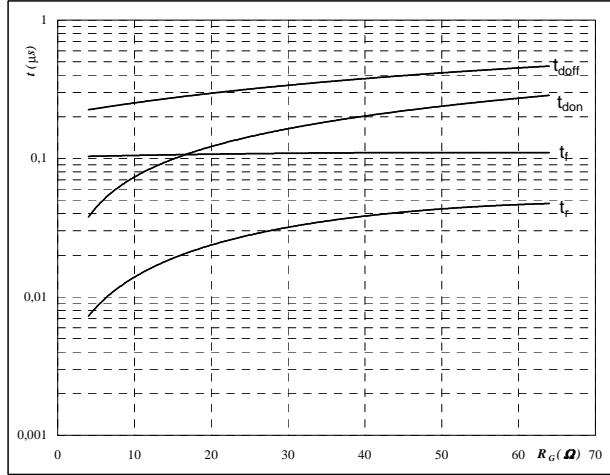

With an inductive load at  
 $T_j = 150 \text{ } ^\circ\text{C}$   
 $V_{CE} = 600 \text{ V}$   
 $V_{GE} = \pm 15 \text{ V}$   
 $I_C = 35 \text{ A}$

**figure 11. FWD**

**Typical reverse recovery time as a function of collector current**  
 $t_{rr} = f(I_C)$

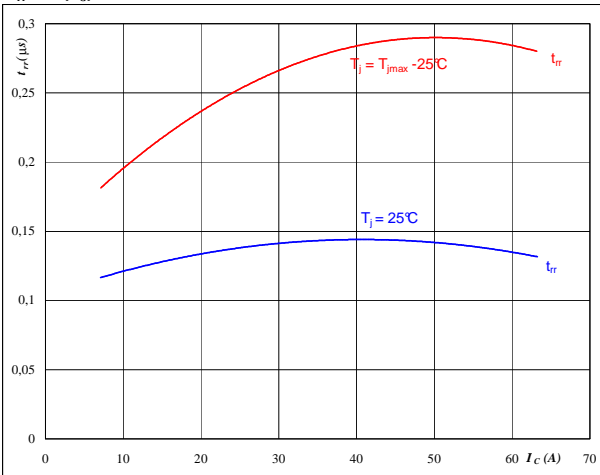

**At**  
 $T_j = 25/150 \text{ } ^\circ\text{C}$   
 $V_{CE} = 600 \text{ V}$   
 $V_{GE} = \pm 15 \text{ V}$   
 $R_{gon} = 16 \text{ } \Omega$

**figure 12. FWD**

**Typical reverse recovery time as a function of IGBT turn on gate resistor**  
 $t_{rr} = f(R_{gon})$

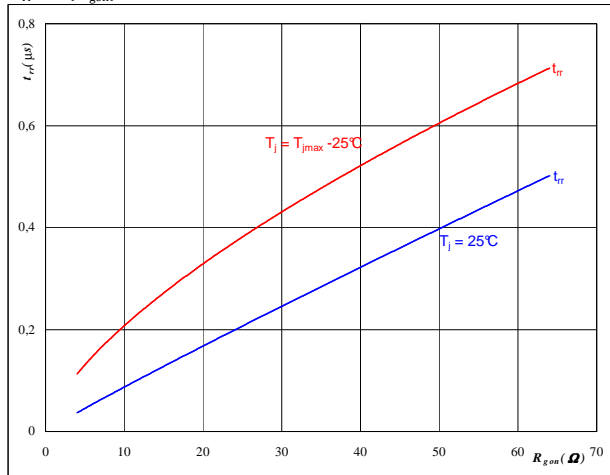

**At**  
 $T_j = 25/150 \text{ } ^\circ\text{C}$   
 $V_R = 600 \text{ V}$   
 $I_F = 35 \text{ A}$   
 $V_{GE} = \pm 15 \text{ V}$



### Inverter Characteristics

figure 13. FWD

Typical reverse recovery charge as a function of collector current

$Q_{rr} = f(I_C)$

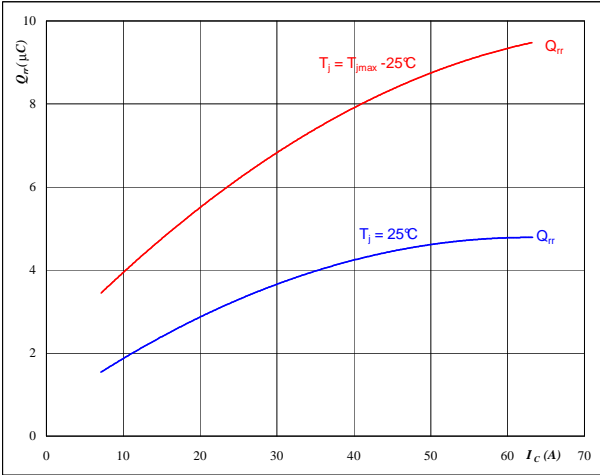

**At**  
 $T_j = 25/150$  °C  
 $V_{CE} = 600$  V  
 $V_{GE} = \pm 15$  V  
 $R_{gon} = 16$  Ω

figure 14. FWD

Typical reverse recovery charge as a function of IGBT turn on gate resistor

$Q_{rr} = f(R_{gon})$

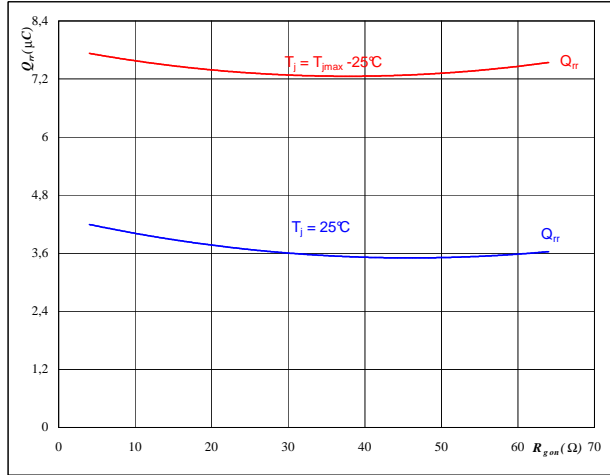

**At**  
 $T_j = 25/150$  °C  
 $V_R = 600$  V  
 $I_F = 35$  A  
 $V_{GE} = \pm 15$  V

figure 15. FWD

Typical reverse recovery current as a function of collector current

$I_{RRM} = f(I_C)$

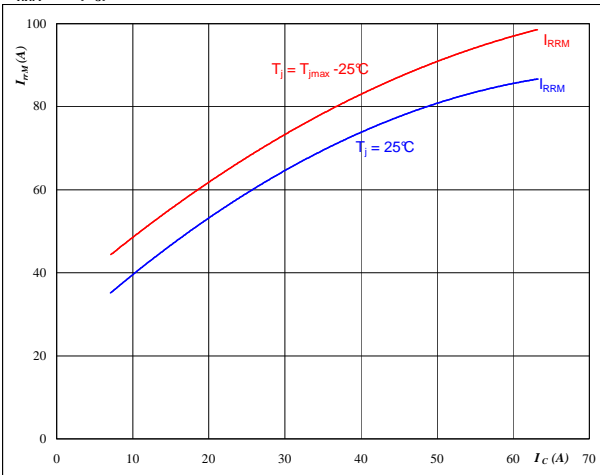

**At**  
 $T_j = 25/150$  °C  
 $V_{CE} = 600$  V  
 $V_{GE} = \pm 15$  V  
 $R_{gon} = 16$  Ω

figure 16. FWD

Typical reverse recovery current as a function of IGBT turn on gate resistor

$I_{RRM} = f(R_{gon})$

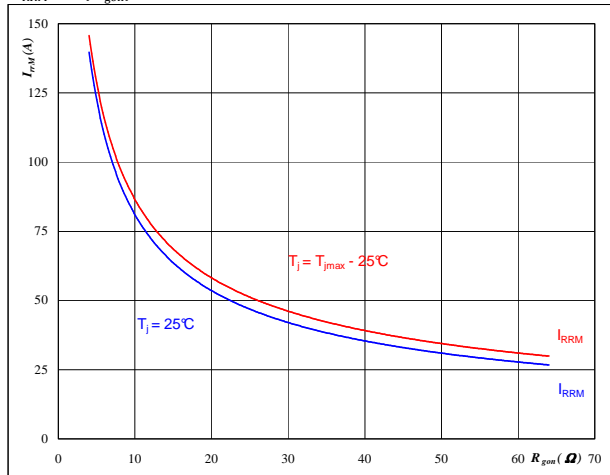

**At**  
 $T_j = 25/150$  °C  
 $V_R = 600$  V  
 $I_F = 35$  A  
 $V_{GE} = \pm 15$  V





# Inverter Characteristics

**figure 17.** FWD

**Typical rate of fall of forward and reverse recovery current as a function of collector current**

$$dI_o/dt, dI_{rec}/dt = f(I_c)$$

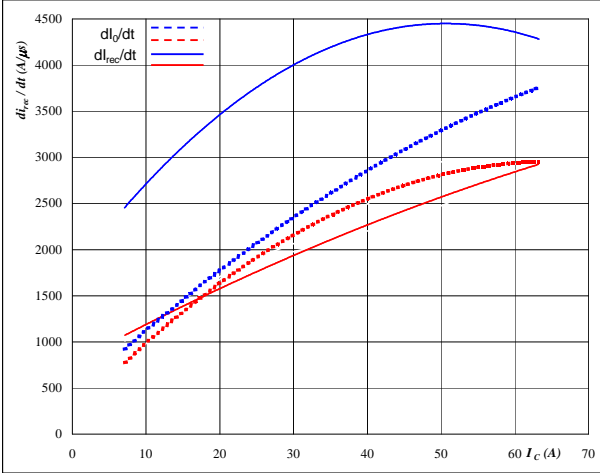

**At**  
 $T_j = 25/150$  °C  
 $V_{CE} = 600$  V  
 $V_{GE} = \pm 15$  V  
 $R_{gon} = 16$  Ω

**figure 18.** FWD

**Typical rate of fall of forward and reverse recovery current as a function of IGBT turn on gate resistor**

$$dI_o/dt, dI_{rec}/dt = f(R_{gon})$$

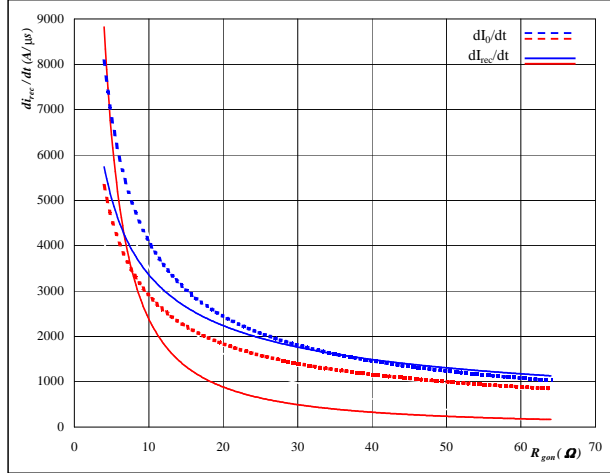

**At**  
 $T_j = 25/150$  °C  
 $V_R = 600$  V  
 $I_F = 35$  A  
 $V_{GE} = \pm 15$  V

**figure 19.** IGBT

**IGBT transient thermal impedance as a function of pulse width**

$$Z_{th(j-s)} = f(t_p)$$

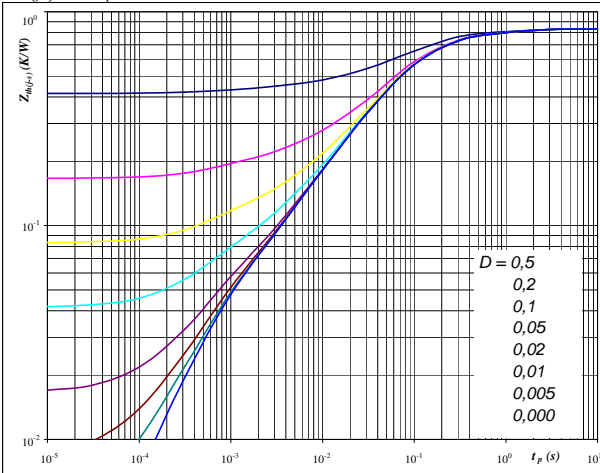

**At**  
 $D = t_p / T$   
 $R_{th(j-s)} = 0,83$  K/W

IGBT thermal model values

R (K/W)	Tau (s)
1,05E-01	8,25E-01
3,41E-01	1,19E-01
2,63E-01	4,37E-02
8,23E-02	7,94E-03
3,86E-02	7,50E-04

**figure 20.** FWD

**FWD transient thermal impedance as a function of pulse width**

$$Z_{th(j-s)} = f(t_p)$$

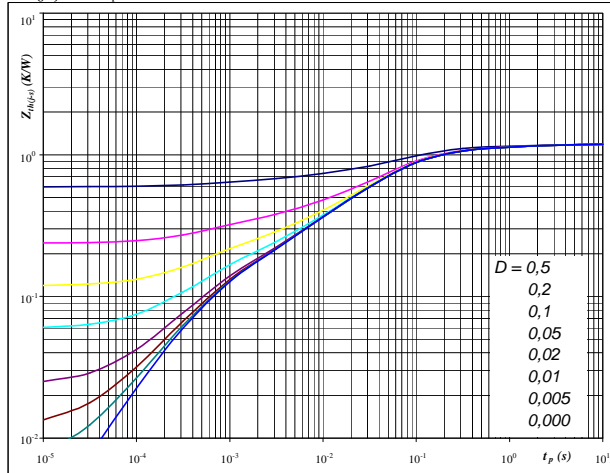

**At**  
 $D = t_p / T$   
 $R_{th(j-s)} = 1,19$  K/W

FWD thermal model values

R (K/W)	Tau (s)
6,30E-02	2,93E+00
1,30E-01	4,06E-01
5,50E-01	7,36E-02
2,26E-01	2,16E-02
1,15E-01	4,46E-03
9,49E-02	5,82E-04
8,50E-03	2,11E-04



### Inverter Characteristics

**figure 21.** IGBT

**Power dissipation as a function of heatsink temperature**

$P_{tot} = f(T_s)$

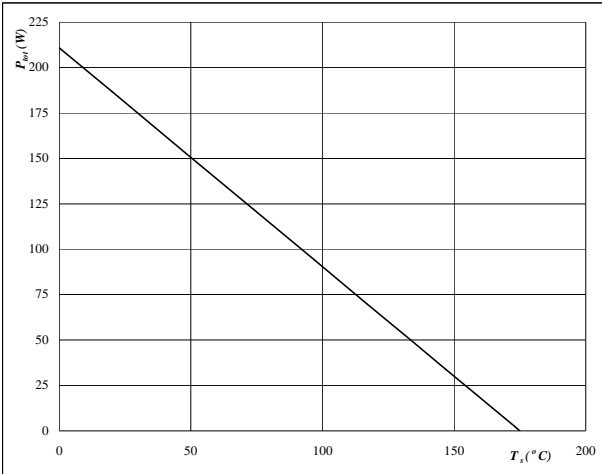

**At**  
T<sub>j</sub> = 175 °C

**figure 22.** IGBT

**Collector current as a function of heatsink temperature**

$I_c = f(T_s)$

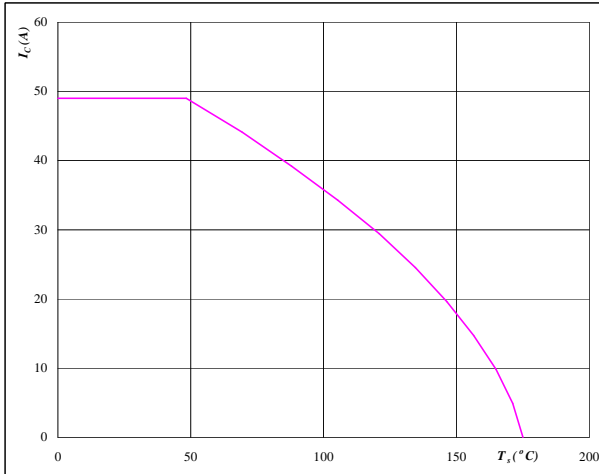

**At**  
T<sub>j</sub> = 175 °C  
V<sub>GE</sub> = 15 V

**figure 23.** FWD

**Power dissipation as a function of heatsink temperature**

$P_{tot} = f(T_s)$

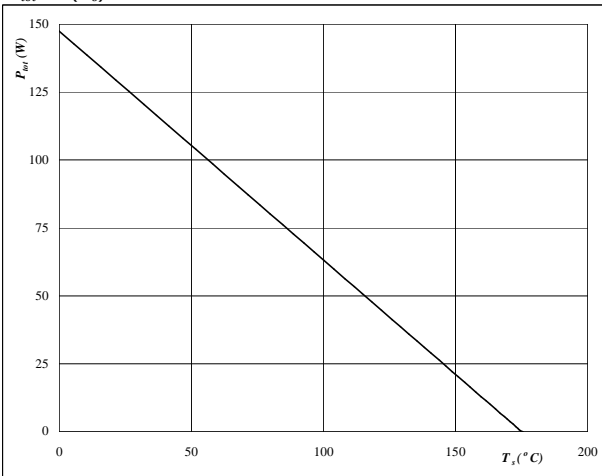

**At**  
T<sub>j</sub> = 175 °C

**figure 24.** FWD

**Forward current as a function of heatsink temperature**

$I_F = f(T_s)$

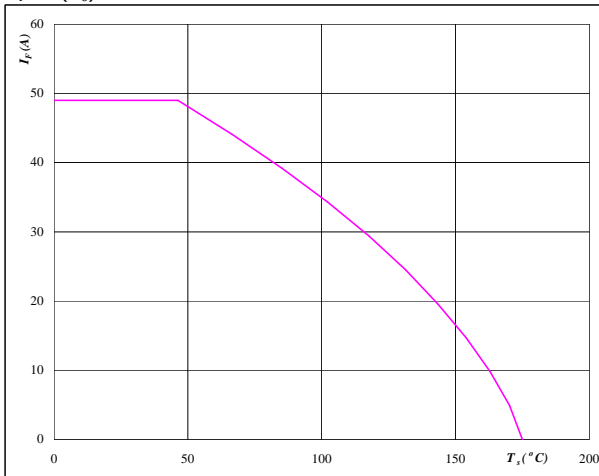

**At**  
T<sub>j</sub> = 175 °C



### Inverter Characteristics

**figure 25.** IGBT

**Safe operating area as a function of collector-emitter voltage**

$I_C = f(V_{CE})$

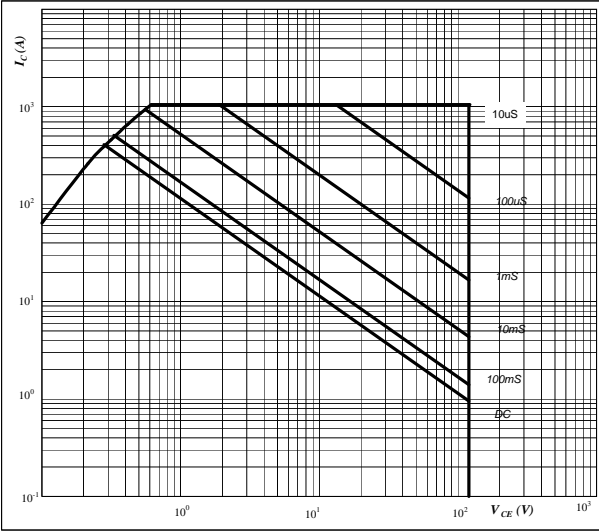

**At**  
 $D =$  single pulse  
 $T_s =$  80 °C  
 $V_{GE} =$  ±15 V  
 $T_j = T_{jmax}$

**figure 26.** IGBT

**Gate voltage vs Gate charge**

$V_{GE} = f(Q_G)$

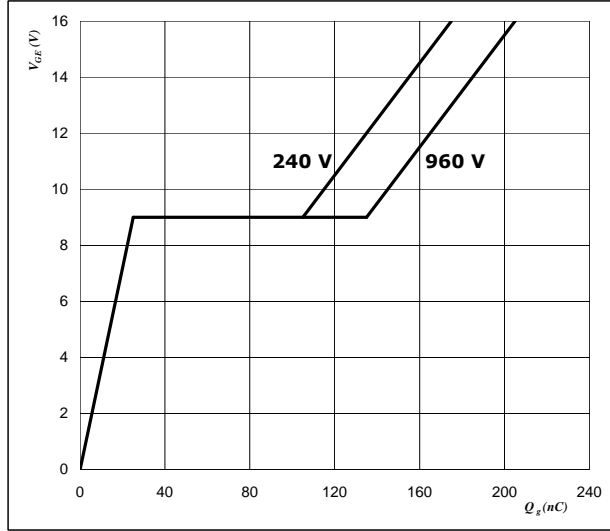

**At**  
 $I_C =$  35 A

**figure 27.** IGBT

**Short circuit withstand time as a function of gate-emitter voltage**

$t_{sc} = f(V_{GE})$

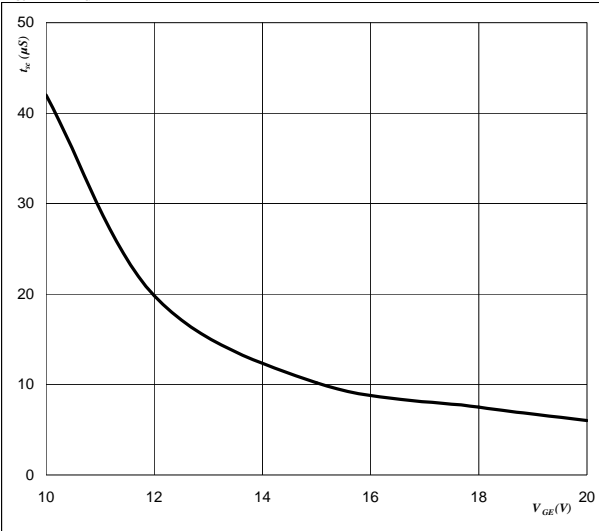

**At**  
 $V_{CE} =$  1200 V  
 $T_j \leq$  175 °C

**figure 28.** IGBT

**Typical short circuit collector current as a function of gate-emitter voltage**

$I_{C(sc)} = f(V_{GE})$

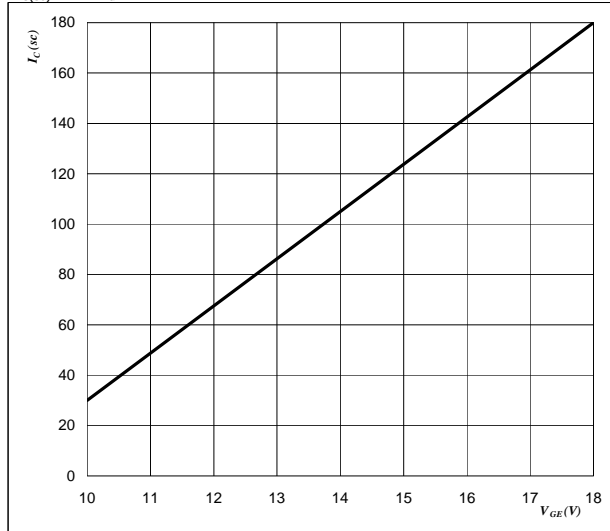

**At**  
 $V_{CE} \leq$  1200 V  
 $T_j =$  175 °C



# Inverter Characteristics

**figure 29.** IGBT  
**Reverse bias safe operating area**

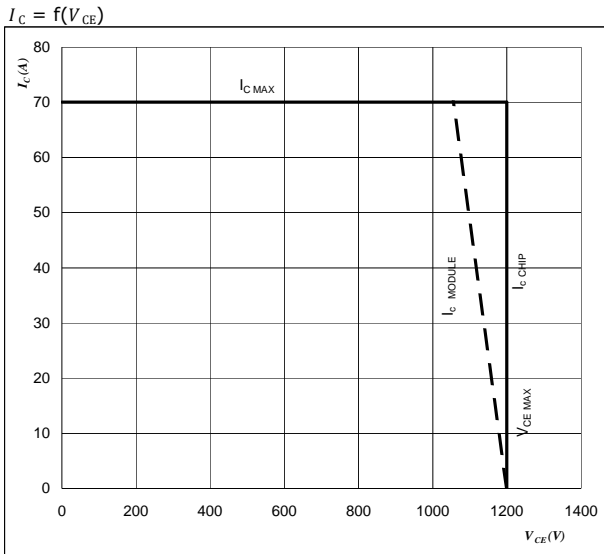

**At**  
 $T_j = T_{j\text{max}} - 25 \text{ } ^\circ\text{C}$



### Brake Characteristics

**figure 1.** IGBT

**Typical output characteristics**

$I_C = f(V_{CE})$

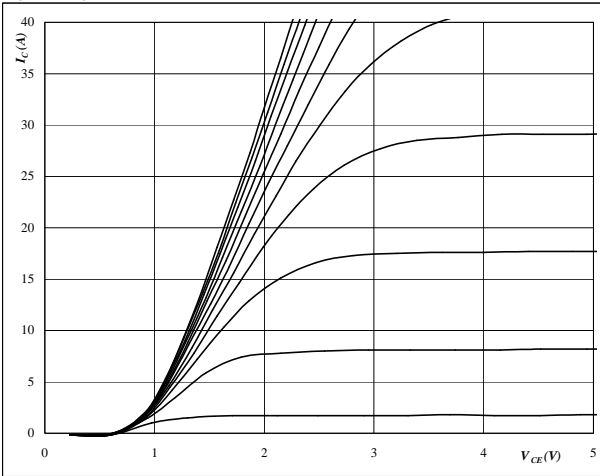

**At**

$t_p = 250 \mu s$   
 $T_j = 25 \text{ }^\circ C$   
 $V_{GE}$  from 7 V to 17 V in steps of 1 V

**figure 2.** IGBT

**Typical output characteristics**

$I_C = f(V_{CE})$

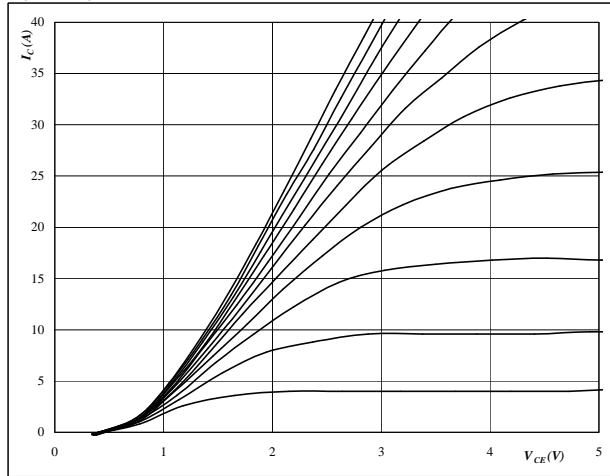

**At**

$t_p = 250 \mu s$   
 $T_j = 150 \text{ }^\circ C$   
 $V_{GE}$  from 7 V to 17 V in steps of 1 V

**figure 3.** IGBT

**Typical transfer characteristics**

$I_C = f(V_{GE})$

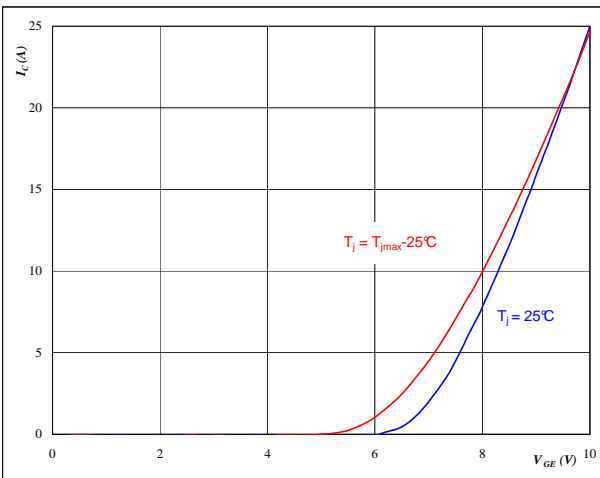

**At**

$t_p = 250 \mu s$   
 $V_{CE} = 10 V$

**figure 4.** FWD

**Typical diode forward current as a function of forward voltage**

$I_F = f(V_F)$

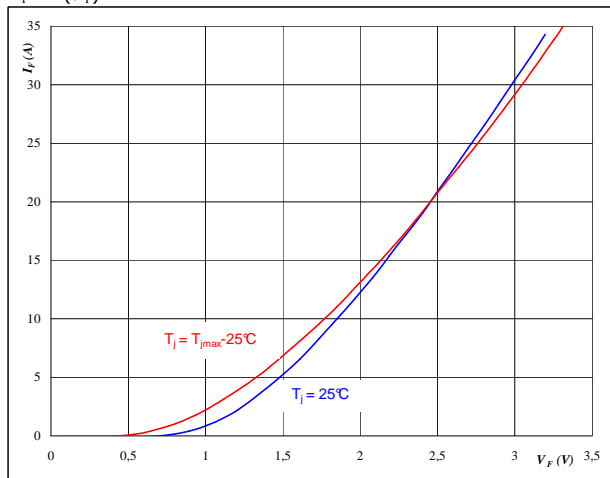

**At**

$t_p = 250 \mu s$



### Brake Characteristics

**figure 5. IGBT**

**Typical switching energy losses as a function of collector current**

$E = f(I_C)$

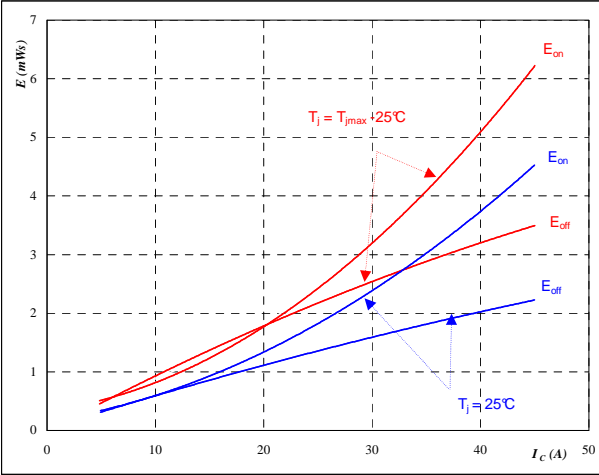

With an inductive load at  
 $T_j = 25/150$  °C  
 $V_{CE} = 600$  V  
 $V_{GE} = \pm 15$  V  
 $R_{gon} = 32$  Ω  
 $R_{goff} = 32$  Ω

**figure 6. IGBT**

**Typical switching energy losses as a function of gate resistor**

$E = f(R_G)$

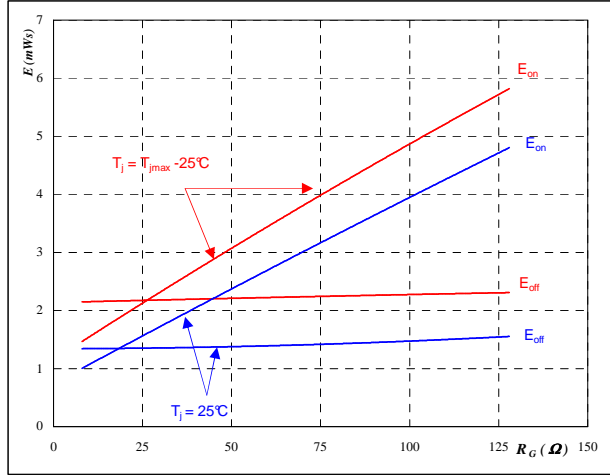

With an inductive load at  
 $T_j = 25/150$  °C  
 $V_{CE} = 600$  V  
 $V_{GE} = \pm 15$  V  
 $I_C = 25$  A

**figure 7. FWD**

**Typical reverse recovery energy loss as a function of collector current**

$E_{rec} = f(I_C)$

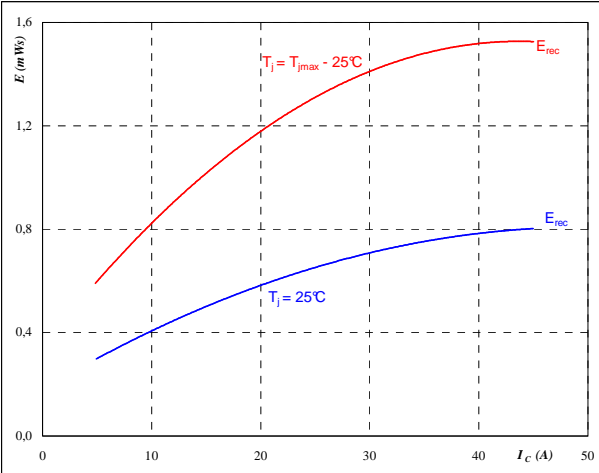

With an inductive load at  
 $T_j = 25/150$  °C  
 $V_{CE} = 600$  V  
 $V_{GE} = \pm 15$  V  
 $R_{gon} = 32$  Ω

**figure 8. FWD**

**Typical reverse recovery energy loss as a function of gate resistor**

$E_{rec} = f(R_G)$

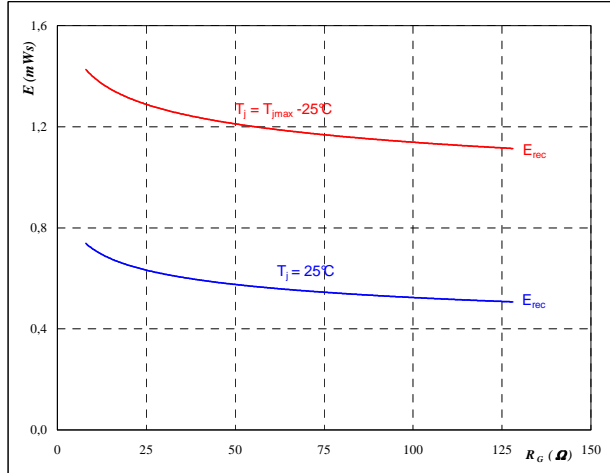

With an inductive load at  
 $T_j = 25/150$  °C  
 $V_{CE} = 600$  V  
 $V_{GE} = \pm 15$  V  
 $I_C = 25$  A



### Brake Characteristics

**figure 9. IGBT**

**Typical switching times as a function of collector current**  
 $t = f(I_c)$

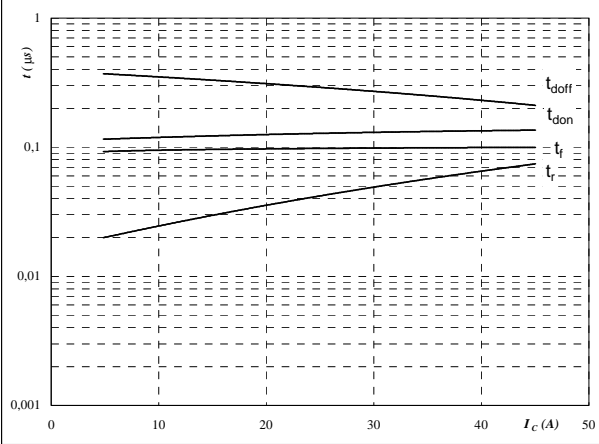

With an inductive load at  
 $T_j = 25/150$  °C  
 $V_{CE} = 600$  V  
 $V_{GE} = \pm 15$  V  
 $R_{gon} = 32$  Ω  
 $R_{goff} = 32$  Ω

**figure 10. IGBT**

**Typical switching times as a function of gate resistor**  
 $t = f(R_g)$

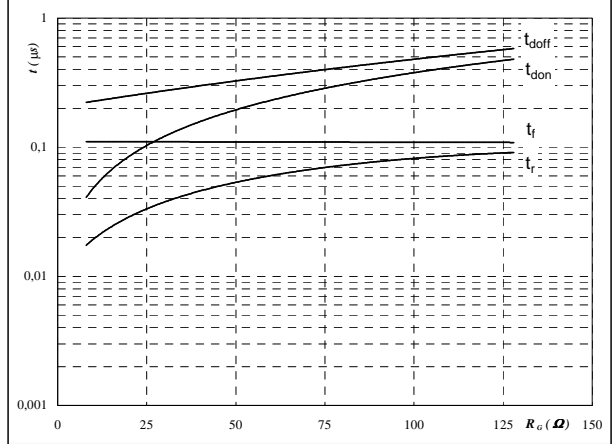

With an inductive load at  
 $T_j = 25/150$  °C  
 $V_{CE} = 600$  V  
 $V_{GE} = \pm 15$  V  
 $I_c = 25$  A

**figure 11. IGBT**

**IGBT transient thermal impedance as a function of pulse width**  
 $Z_{th(j-s)} = f(t_p)$

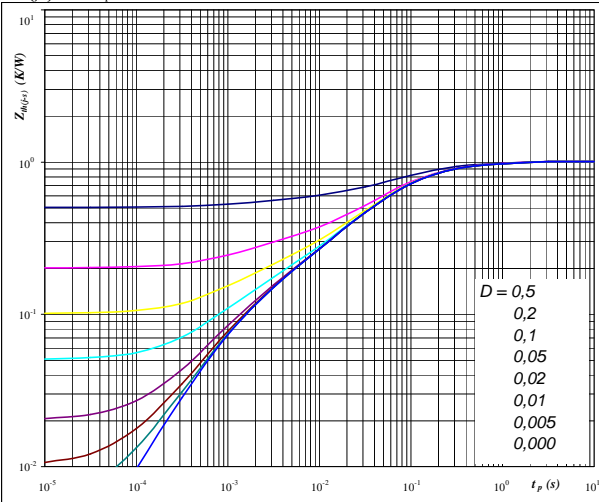

**At**  $D = t_p / T$   
 $R_{th(j-s)} = 1,01$  K/W  
**IGBT thermal model values**

R (K/W)	Tau (s)
8,44E-02	1,03E+00
2,46E-01	1,79E-01
4,48E-01	5,38E-02
1,38E-01	1,04E-02
5,48E-02	1,66E-03
3,85E-02	8,73E-04

**figure 12. FWD**

**FWD transient thermal impedance as a function of pulse width**  
 $Z_{th(j-s)} = f(t_p)$

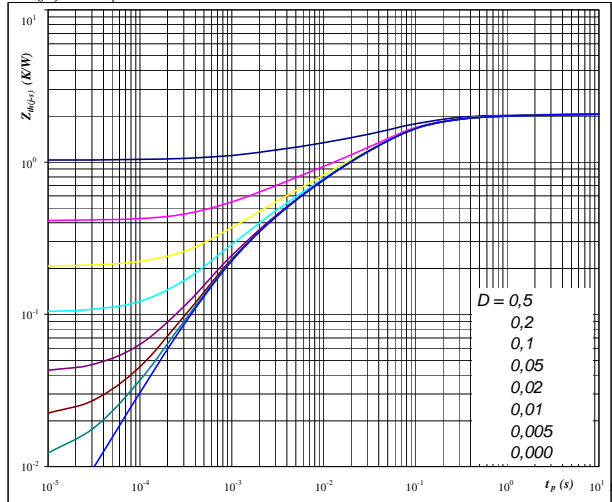

**At**  $D = t_p / T$   
 $R_{th(j-s)} = 2,07$  K/W  
**FWD thermal model values**

R (K/W)	Tau (s)
5,09E-02	4,26E+00
1,55E-01	5,03E-01
7,75E-01	7,89E-02
5,33E-01	2,68E-02
3,54E-01	5,03E-03
1,97E-01	9,09E-04



### Brake Characteristics

**figure 13.** IGBT

**Power dissipation as a function of heatsink temperature**

$$P_{tot} = f(T_s)$$

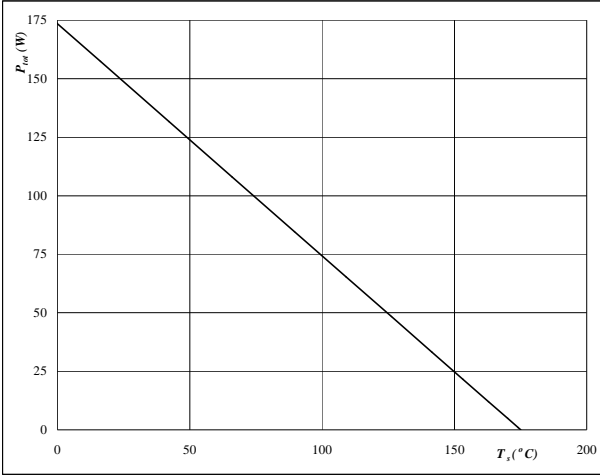

**At**  
T<sub>j</sub> = 175 °C

**figure 14.** IGBT

**Collector current as a function of heatsink temperature**

$$I_c = f(T_s)$$

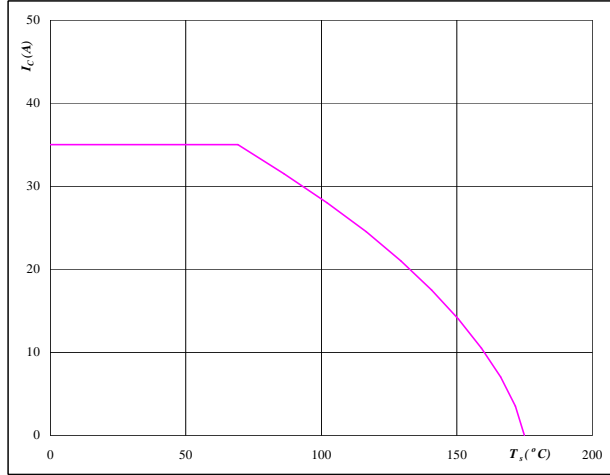

**At**  
T<sub>j</sub> = 175 °C  
V<sub>GE</sub> = 15 V

**figure 15.** FWD

**Power dissipation as a function of heatsink temperature**

$$P_{tot} = f(T_s)$$

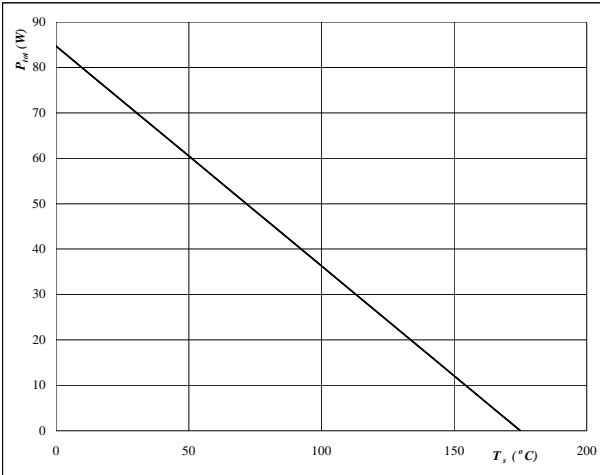

**At**  
T<sub>j</sub> = 175 °C

**figure 16.** FWD

**Forward current as a function of heatsink temperature**

$$I_F = f(T_s)$$

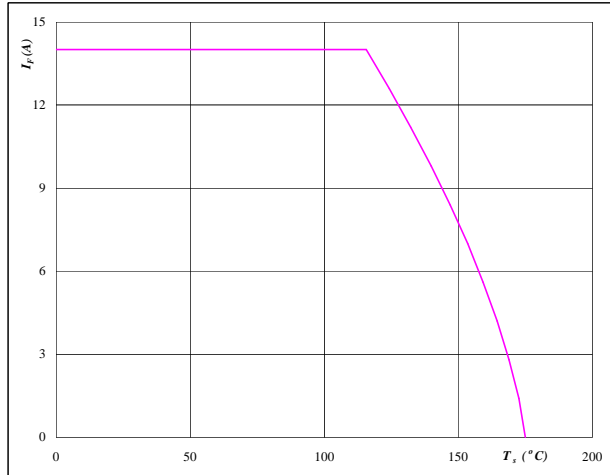

**At**  
T<sub>j</sub> = 175 °C





# Rectifier Diode

**figure 1. Rectifier Diode**

**Typical diode forward current as a function of forward voltage**

$I_F = f(V_F)$

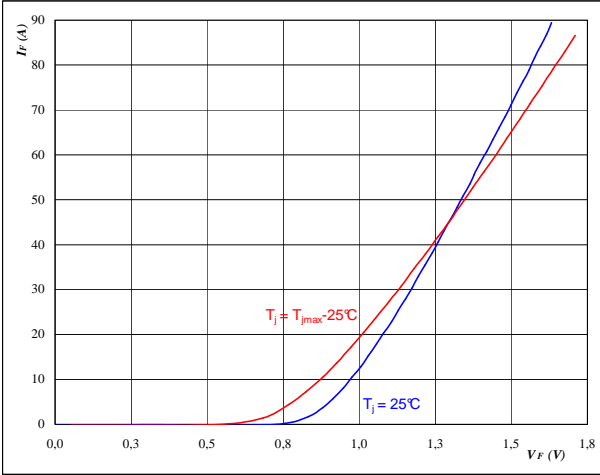

**At**  
 $t_p = 250 \mu s$

**figure 2. Rectifier Diode**

**Diode transient thermal impedance as a function of pulse width**

$Z_{th(f-s)} = f(t_p)$

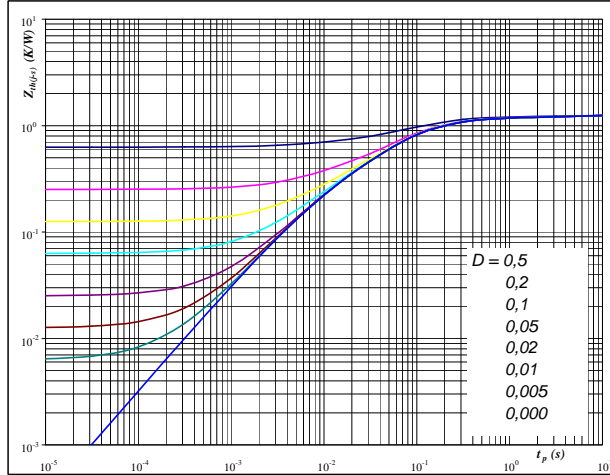

**At**  
 $R_{th(f-s)} = 1,25 \text{ K/W}$   
 Diode thermal model values

R (K/W)	Tau (s)
8,00E-02	5,22E+00
1,56E-01	4,18E-01
6,95E-01	8,82E-02
2,23E-01	3,07E-02
9,97E-02	5,99E-03

**figure 3. Rectifier Diode**

**Power dissipation as a function of heatsink temperature**

$P_{tot} = f(T_s)$

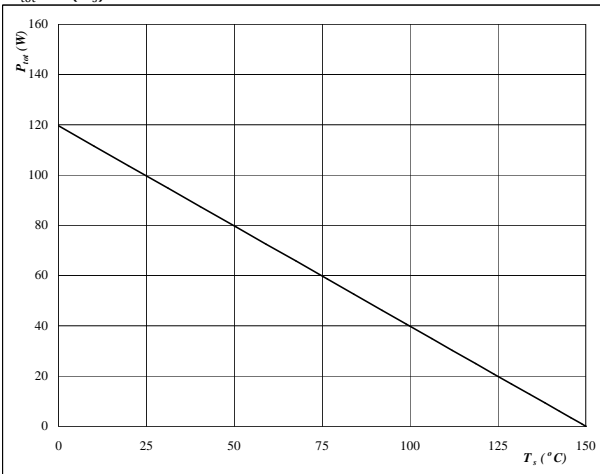

**At**  
 $T_j = 150 \text{ }^\circ\text{C}$

**figure 4. Rectifier Diode**

**Forward current as a function of heatsink temperature**

$I_F = f(T_s)$

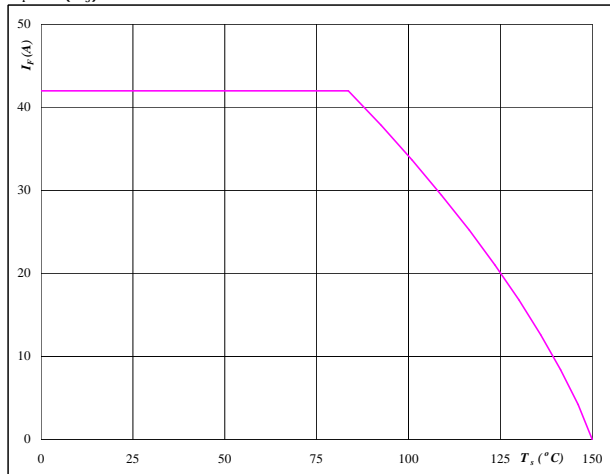

**At**  
 $T_j = 150 \text{ }^\circ\text{C}$



# Thermistor

**figure 1. Thermistor**

**Typical NTC characteristic  
as a function of temperature**

$$R = f(T)$$

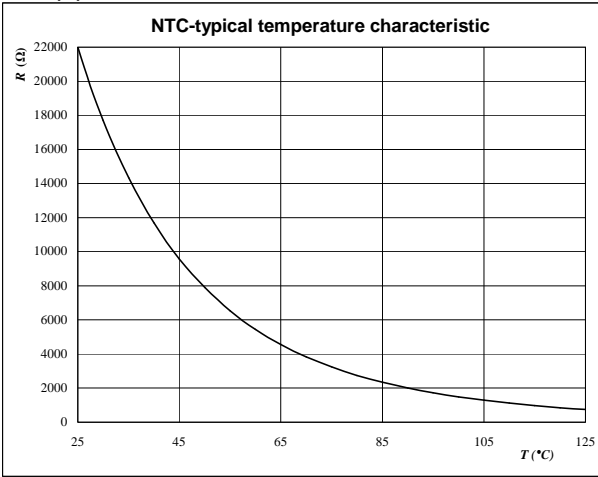



## Switching Definitions Inverter

### General conditions

$T_j$	=	150 °C
$R_{gon}$	=	16 Ω
$R_{goff}$	=	16 Ω

**figure 1.** IGBT

**Turn-off Switching Waveforms & definition of  $t_{doff}$ ,  $t_{Eoff}$**   
( $t_{Eoff}$  = integrating time for  $E_{off}$ )

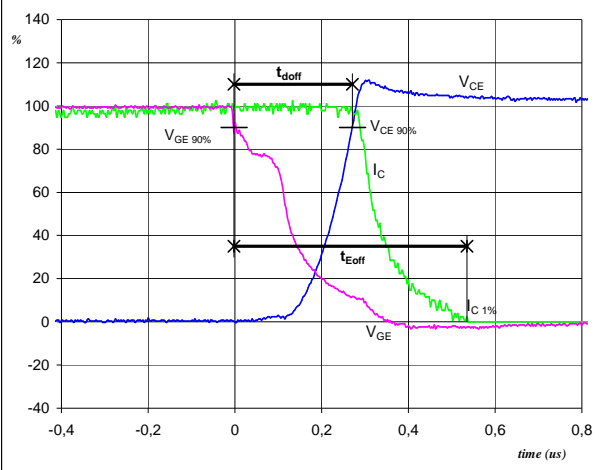

$V_{GE}$ (0%) =	-15	V
$V_{GE}$ (100%) =	15	V
$V_C$ (100%) =	600	V
$I_C$ (100%) =	35	A
$t_{doff}$ =	0,27	μs
$t_{Eoff}$ =	0,54	μs

**figure 2.** IGBT

**Turn-on Switching Waveforms & definition of  $t_{don}$ ,  $t_{Eon}$**   
( $t_{Eon}$  = integrating time for  $E_{on}$ )

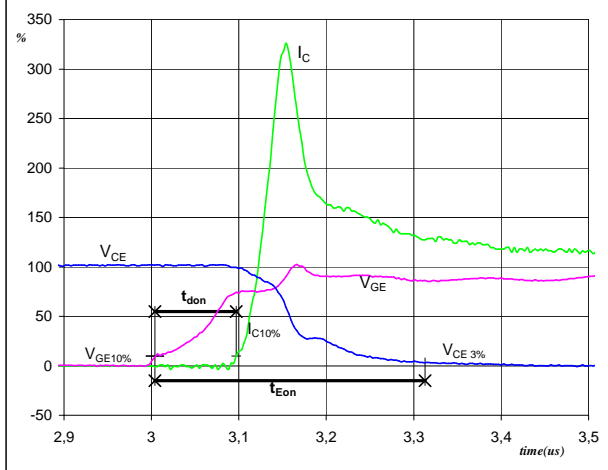

$V_{GE}$ (0%) =	-15	V
$V_{GE}$ (100%) =	15	V
$V_C$ (100%) =	600	V
$I_C$ (100%) =	35	A
$t_{don}$ =	0,09	μs
$t_{Eon}$ =	0,31	μs

**figure 3.** IGBT

**Turn-off Switching Waveforms & definition of  $t_f$**

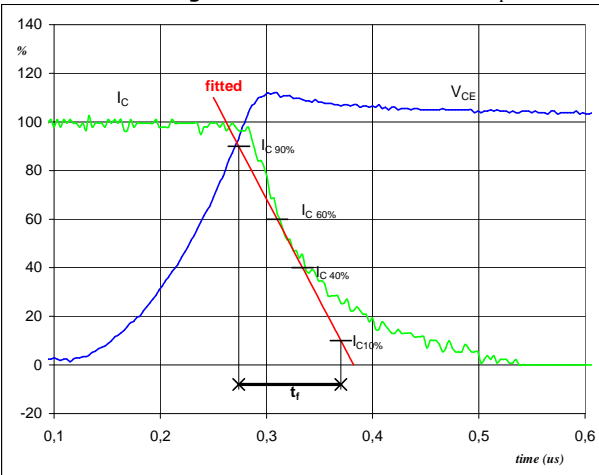

$V_C$ (100%) =	600	V
$I_C$ (100%) =	35	A
$t_f$ =	0,11	μs

**figure 4.** IGBT

**Turn-on Switching Waveforms & definition of  $t_r$**

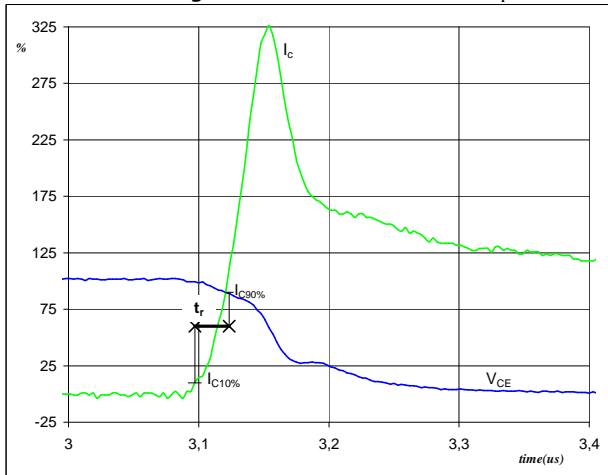

$V_C$ (100%) =	600	V
$I_C$ (100%) =	35	A
$t_r$ =	0,02	μs



## Switching Definitions Inverter

**figure 5.** IGBT

**Turn-off Switching Waveforms & definition of  $t_{Eoff}$**

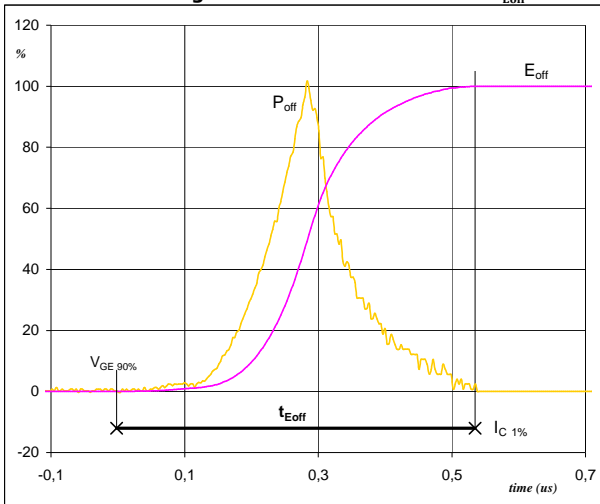

$P_{off} (100\%) = 21,01 \text{ kW}$   
 $E_{off} (100\%) = 2,82 \text{ mJ}$   
 $t_{Eoff} = 0,54 \text{ }\mu\text{s}$

**figure 6.** IGBT

**Turn-on Switching Waveforms & definition of  $t_{Eon}$**

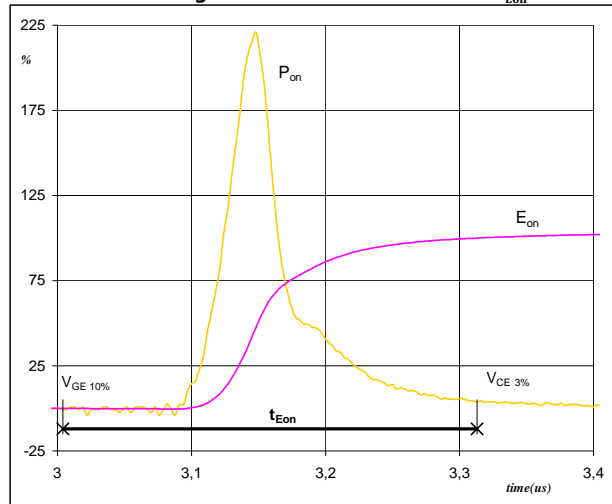

$P_{on} (100\%) = 21,01 \text{ kW}$   
 $E_{on} (100\%) = 2,49 \text{ mJ}$   
 $t_{Eon} = 0,31 \text{ }\mu\text{s}$

**figure 7.** IGBT

**Turn-off Switching Waveforms & definition of  $t_{rr}$**

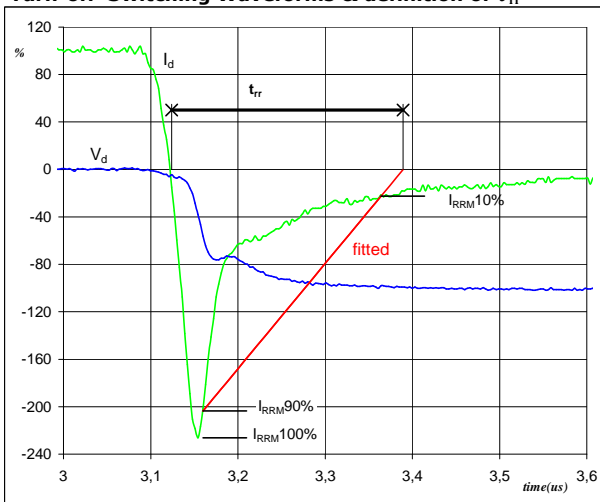

$V_d (100\%) = 600 \text{ V}$   
 $I_d (100\%) = 35 \text{ A}$   
 $I_{RRM} (100\%) = -79 \text{ A}$   
 $t_{rr} = 0,28 \text{ }\mu\text{s}$



### Switching Definitions Inverter

**figure 8.** FWD

**Turn-on Switching Waveforms & definition of  $t_{Qrr}$**   
( $t_{Qrr}$  = integrating time for  $Q_{rr}$ )

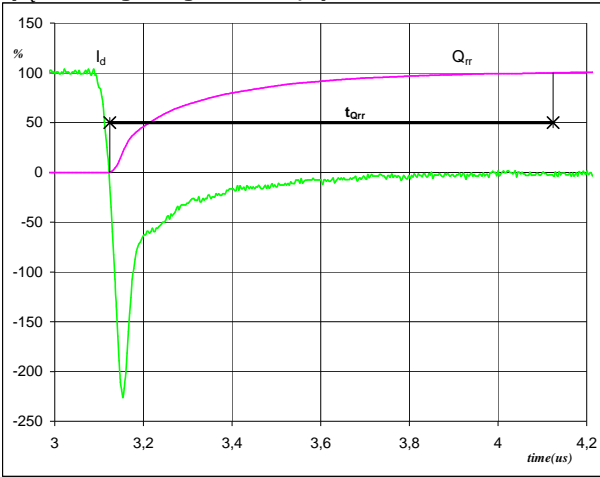

$I_d$ (100%) =	35	A
$Q_{rr}$ (100%) =	7,47	$\mu\text{C}$
$t_{Qrr}$ =	1,00	$\mu\text{s}$

**figure 9.** FWD

**Turn-on Switching Waveforms & definition of  $t_{Erec}$**   
( $t_{Erec}$  = integrating time for  $E_{rec}$ )

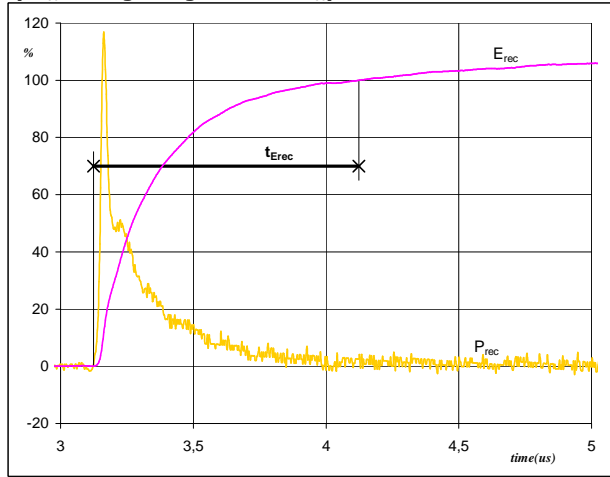

$P_{rec}$ (100%) =	21,01	kW
$E_{rec}$ (100%) =	3,31	mJ
$t_{Erec}$ =	1,00	$\mu\text{s}$



## Ordering Code and Marking - Outline - Pinout

Version		Ordering Code					
without thermal paste 17mm housing solder pins		V23990-P580-A41-PM					
with thermal paste 17mm housing solder pins		V23990-P580-A41-/3/-PM					
without thermal paste 17mm housing press-fit pins		V23990-P580-A41Y-PM					
with thermal paste 17mm housing press-fit pins		V23990-P580-A41Y-/3/-PM					
without thermal paste 12mm housing solder pins		V23990-P580-A418-PM					
with thermal paste 12mm housing solder pins		V23990-P580-A418-/3/-PM					
without thermal paste 12mm housing press-fit pins		V23990-P580-A418Y-PM					
with thermal paste 12mm housing press-fit pins		V23990-P580-A418Y-/3/-PM					
without thermal paste 17mm housing solder pins without brake		V23990-P580-C41-PM					
with thermal paste 17mm housing solder pins without brake		V23990-P580-C41-/3/-PM					
without thermal paste 17mm housing press-fit pins without brake		V23990-P580-C41Y-PM					
with thermal paste 17mm housing press-fit pins without brake		V23990-P580-C41Y-/3/-PM					
without thermal paste 12mm housing press-fit pins without brake		V23990-P580-C418Y-PM					
with thermal paste 12mm housing press-fit pins without brake		V23990-P580-C418Y-/3/-PM					

  

	<b>Text</b>	<b>VIN</b>	<b>Date code</b>	<b>Name&amp;Ver</b>	<b>UL</b>	<b>Lot</b>	<b>Serial</b>
		VIN	WWYY	NNNNNNVV	UL	LLLLL	SSSS
	<b>Datamatrix</b>	<b>Type&amp;Ver</b>		<b>Lot number</b>	<b>Serial</b>	<b>Date code</b>	
		TTTTTIV		LLLLL	SSSS	WWYY	

Pin table				module	whitout pins	Outline
Pin	X	Y	Function	P589-C41	1, 31, 32	
1	52,55	0	BrG	P589-C418	1, 31, 32	
2	47,7	0	DC-			
3	44,8	0	DC-	12 mm solder pin		
4	37,8	0	DC+			
5	37,8	2,8	DC+			
6	35	0	Inv+			
7	35	2,8	Inv+			
8	28	0	R1	12 mm press-fit pin		
9	25,2	0	R2			
10	22,4	0	N6			
11	19,6	0	G6			
12	16,8	0	S6			
13	14	0	N4	17 mm solder pin		
14	11,2	0	G4			
15	8,4	0	S4			
16	5,6	0	N2			
17	2,8	0	G2			
18	0	0	S2	17 mm press-fit pin		
19	0	28,5	U			
20	2,8	28,5	G1			
21	7,5	28,5	S1			
22	14,5	28,5	V			
23	17,3	28,5	G3			
24	22	28,5	S3			
25	29	28,5	W			
26	31,8	28,5	G5			
27	36,5	28,5	S5			
28	43,5	28,5	L1			
29	52,55	25	L2			
30	52,55	16,9	L3			
31	52,55	8,6	BrC			
32	52,55	2,8	BrE			



Vincotech

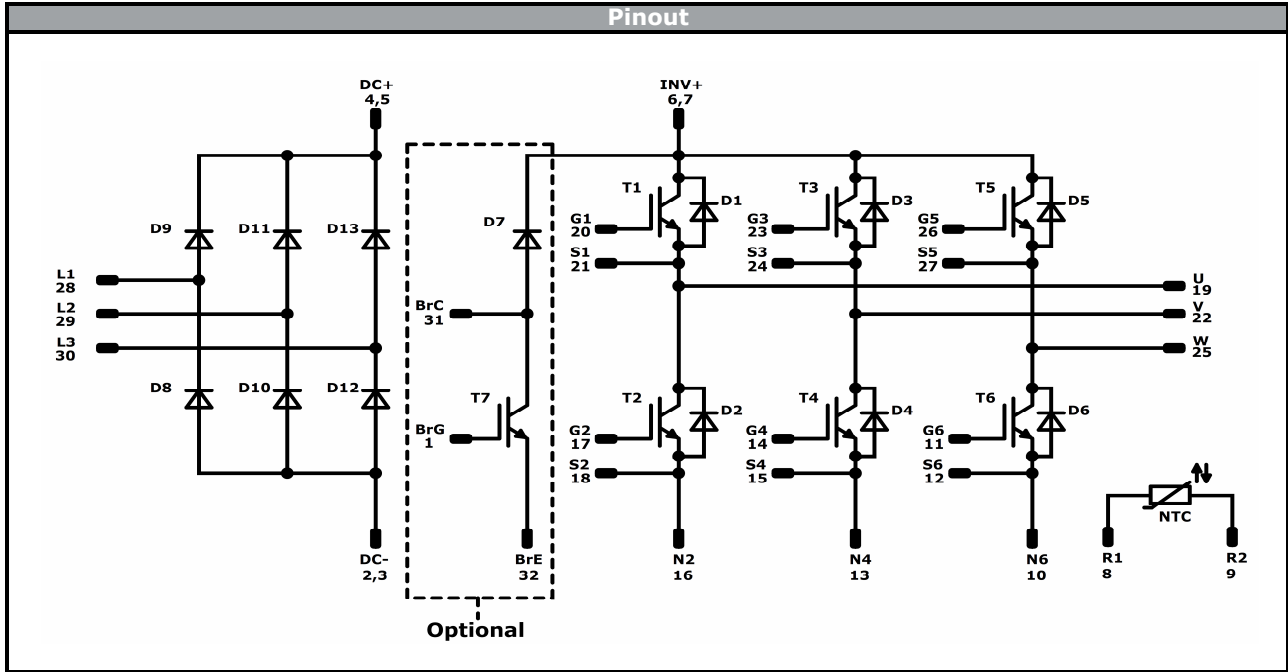

Identification					
ID	Component	Voltage	Current	Function	Comment
T1,T2,T3,T4,T5,T6	IGBT	1200 V	35 A	Inverter Switch	
D1,D2,D3,D4,D5,D6	FWD	1200 V	35 A	Inverter Diode	
T7	IGBT	1200 V	25 A	Brake Switch	
D7	FWD	1200 V	10 A	Brake Diode	
D8,D9,D10,D11,D12,D13	Rectifier	1600 V	35 A	Rectifier Diode	
NTC	NTC			Thermistor	



Packaging instruction			
Standard packaging quantity (SPQ)	<b>100</b>	>SPQ	Standard
		<SPQ	Sample

Handling instruction
Handling instructions for <i>flow</i> 1 packages see vincotech.com website.

Package data
Package data for <i>flow</i> 1 packages see vincotech.com website.

UL recognition and file number
This device is certified according to UL 1557 standard, UL file number E192116. For more information see vincotech.com website. 

Document No.:	Date:	Modification:	Pages
V23990-P580-x4x-D9-14	18 Dec. 2018	Isolation Voltage updated	2

**DISCLAIMER**

The information, specifications, procedures, methods and recommendations herein (together "information") are presented by Vincotech to reader in good faith, are believed to be accurate and reliable, but may well be incomplete and/or not applicable to all conditions or situations that may exist or occur. Vincotech reserves the right to make any changes without further notice to any products to improve reliability, function or design. No representation, guarantee or warranty is made to reader as to the accuracy, reliability or completeness of said information or that the application or use of any of the same will avoid hazards, accidents, losses, damages or injury of any kind to persons or property or that the same will not infringe third parties rights or give desired results. It is reader's sole responsibility to test and determine the suitability of the information and the product for reader's intended use.

**LIFE SUPPORT POLICY**

Vincotech products are not authorised for use as critical components in life support devices or systems without the express written approval of Vincotech.

As used herein:

1. Life support devices or systems are devices or systems which, (a) are intended for surgical implant into the body, or (b) support or sustain life, or (c) whose failure to perform when properly used in accordance with instructions for use provided in labelling can be reasonably expected to result in significant injury to the user.
2. A critical component is any component of a life support device or system whose failure to perform can be reasonably expected to cause the failure of the life support device or system, or to affect its safety or effectiveness.



单击下面可查看定价，库存，交付和生命周期等信息

[>>Vincotech\(威科\)](#)