

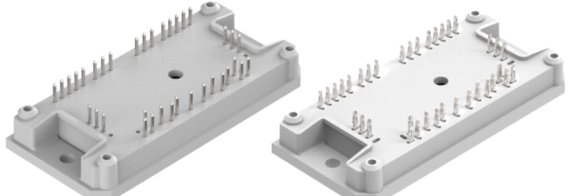
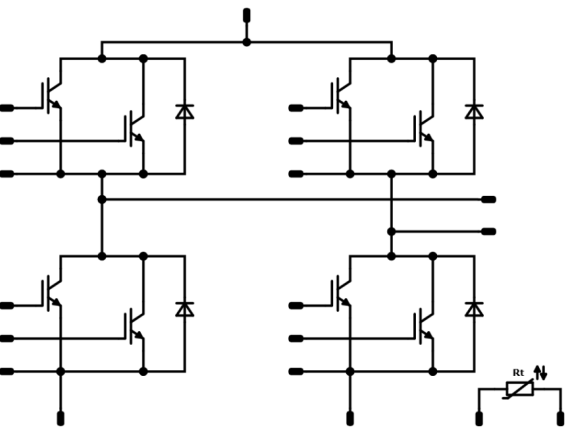

Vincotech

fastPACK 1 H	1200 V / 80 A
<div style="background-color: #eee; padding: 5px; margin-bottom: 5px;">Features</div> <ul style="list-style-type: none"> High speed IGBT Fast, soft reverse Diode Open emitter topology Integrated thermistor 	<div style="background-color: #eee; padding: 5px; margin-bottom: 5px;">flow 1 12 mm housing</div> <div style="text-align: center;">  </div> <div style="display: flex; justify-content: space-around; font-size: small;"> Solder Pins Press-fit Pins </div>
<div style="background-color: #eee; padding: 5px; margin-bottom: 5px;">Target applications</div> <ul style="list-style-type: none"> Charger SMPS Solar Welding ESS 	<div style="background-color: #eee; padding: 5px; margin-bottom: 5px;">Schematic</div> 
<div style="background-color: #eee; padding: 5px; margin-bottom: 5px;">Types</div> <ul style="list-style-type: none"> 10-FY124PA080SH-L589F48 10-PY124PA080SH-L589F48Y 	

Maximum Ratings

$T_j = 25\text{ }^\circ\text{C}$, unless otherwise specified

Parameter	Symbol	Condition	Value	Unit
H-Bridge Switch				
Collector-emitter voltage	V_{CES}		1200	V
Collector current	I_C	$T_j = T_{jmax}$ $T_s = 80\text{ }^\circ\text{C}$	71	A
Repetitive peak collector current	I_{CRM}	t_p limited by T_{jmax}	240	A
Total power dissipation	P_{tot}	$T_j = T_{jmax}$ $T_s = 80\text{ }^\circ\text{C}$	166	W
Gate-emitter voltage	V_{GEs}		± 20	V
Short circuit ratings	t_{SC}	$T_j \leq 150\text{ }^\circ\text{C}$	10	μs
	V_{CC}	$V_{GE} = 15\text{ V}$	800	V
Maximum Junction Temperature	T_{jmax}		175	$^\circ\text{C}$



Vincotech

Maximum Ratings

$T_j = 25\text{ °C}$, unless otherwise specified

Parameter	Symbol	Condition	Value	Unit
H-Bridge Diode				
Peak Repetitive Reverse Voltage	V_{RRM}		1200	V
Continuous (direct) forward current	I_F	$T_j = T_{jmax}$ $T_s = 80\text{ °C}$	46	A
Surge (non-repetitive) forward current	I_{FSM}	50 Hz Single Half Sine Wave $t_p = 10\text{ ms}$ $T_j = 150\text{ °C}$	270	A
Surge current capability	I_{2t}		365	A ² s
Total power dissipation	P_{tot}	$T_j = T_{jmax}$ $T_s = 80\text{ °C}$	98	W
Maximum Junction Temperature	T_{jmax}		175	°C

Module Properties

Thermal Properties

Storage temperature	T_{stg}		-40...+125	°C
Operation temperature under switching condition	T_{jop}		-40...(T _{jmax} - 25)	°C

Isolation Properties

Isolation voltage	V_{isol}	DC Test Voltage* $t_p = 2\text{ s}$	6000	V
		AC Voltage $t_p = 1\text{ min}$	2500	mm
Creepage distance			min. 12,7	mm
Clearance		with solder pins / with press-fit pins	8,1 / 7,92	mm
Comparative Tracking Index	CTI		> 200	

*100 % tested in production



Characteristic Values

Parameter	Symbol	Conditions					Value			Unit
		V_{GS} [V]	V_{GE} [V]	V_{DS} [V]	I_D [A]	T_j [°C]	Min	Typ	Max	

H-Bridge Switch

Static

Parameter	Symbol	$V_{GE} = V_{CE}$	V_{GS} [V]	V_{CE} [V]	I_C [A]	T_j [°C]	Min	Typ	Max	Unit
Gate-emitter threshold voltage	$V_{GE(th)}$				0,003	25	5,3	5,8	6,3	V
Collector-emitter saturation voltage	V_{CEsat}		15		80	25 125 150	1,78	1,99 2,33 2,41	2,42	V
Collector-emitter cut-off current	I_{CES}		0	1200		25			10	μA
Gate-emitter leakage current	I_{GES}		20	0		25			240	nA
Internal gate resistance	r_g							none		Ω
Input capacitance	C_{ies}							4660		pF
Output capacitance	C_{oes}	$f = 1\text{MHz}$	0	25		25		300		
Reverse transfer capacitance	C_{res}							260		
Gate charge	Q_g		15	960	80	25		370		nC

Thermal

Parameter	Symbol	Material	λ [W/mK]	Min	Typ	Max	Unit
Thermal resistance junction to sink	$R_{th(j-s)}$	phase-change material	3,4				K/W

Dynamic

Parameter	Symbol	$R_{goff} = 4\ \Omega$ $R_{gon} = 4\ \Omega$	V_{GS} [V]	V_{CE} [V]	I_D [A]	T_j [°C]	Min	Typ	Max	Unit
Turn-on delay time	$t_{d(on)}$					25 125 150		72 73 73		ns
Rise time	t_r					25 125 150		11 13 13		
Turn-off delay time	$t_{d(off)}$					25 125 150		179 233 248		
Fall time	t_f					25 125 150		35 78 93		
Turn-on energy (per pulse)	E_{on}	$Q_{tFWD} = 6,4\ \mu\text{C}$ $Q_{tFWD} = 10,7\ \mu\text{C}$ $Q_{tFWD} = 12,7\ \mu\text{C}$				25 125 150		1,705 2,633 3,049		mWs
Turn-off energy (per pulse)	E_{off}					25 125 150		3,358 5,377 5,997		



Characteristic Values

Parameter	Symbol	Conditions					Value			Unit
		V_{GS} [V]	V_{GE} [V]	V_{DS} [V]	I_D [A]	T_j [°C]	Min	Typ	Max	

H-Bridge Diode

Static

Forward voltage	V_F				50	25 150		2,19 2,21	2,54	V
Reverse leakage current	I_r			1200		25 150			60 8800	μA

Thermal

Thermal resistance junction to sink	$R_{th(j-s)}$	phase-change material $\lambda = 3,4$ W/mK						0,97		K/W
-------------------------------------	---------------	---	--	--	--	--	--	------	--	-----

Dynamic

Peak recovery current	I_{RRM}					25 125 150		165 194 204		A
Reverse recovery time	t_{rr}					25 125 150		35 101 123		ns
Recovered charge	Q_r	$di/dt = 10206$ A/μs $di/dt = 7449$ A/μs $di/dt = 7007$ A/μs	±15	600	80	25 125 150		6,382 10,712 12,685		μC
Reverse recovered energy	E_{rec}					25 125 150		3,059 5,172 6,086		mWs
Peak rate of fall of recovery current	$(di_{rf}/dt)_{max}$					25 125 150		8909 8599 9104		A/μs

Thermistor

Rated resistance	R					25		22		kΩ
Deviation of R_{100}	$\Delta_{R/R}$	$R_{100} = 1484$ Ω				100	-5		5	%
Power dissipation	P					25		5		mW
Power dissipation constant						25		1,5		mW/K
B-value	$B_{(25/50)}$	Tol. ±1 %				25		3962		K
B-value	$B_{(25/100)}$	Tol. ±1 %				25		4000		K
Vincotech NTC Reference									I	



Vincotech

H-Bridge Switch Characteristics

Typical output characteristics IGBT

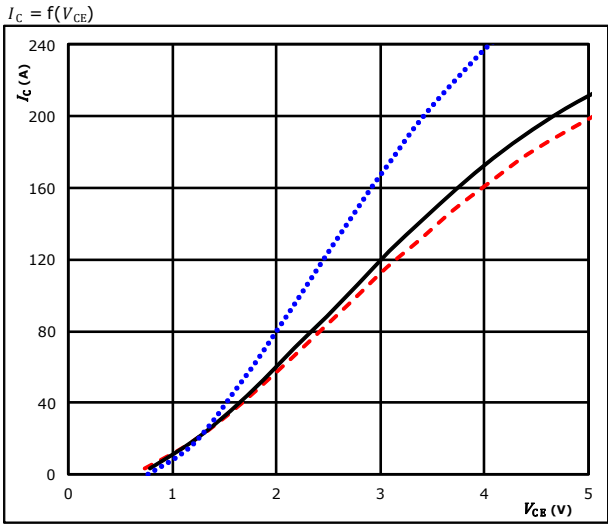

Typical output characteristics IGBT

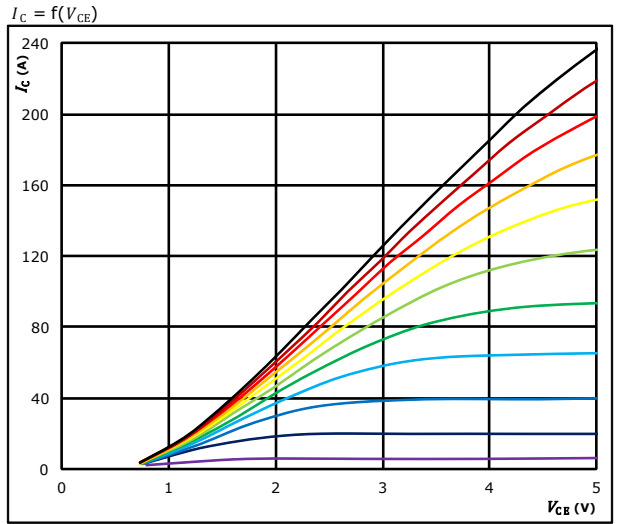

Typical transfer characteristics IGBT

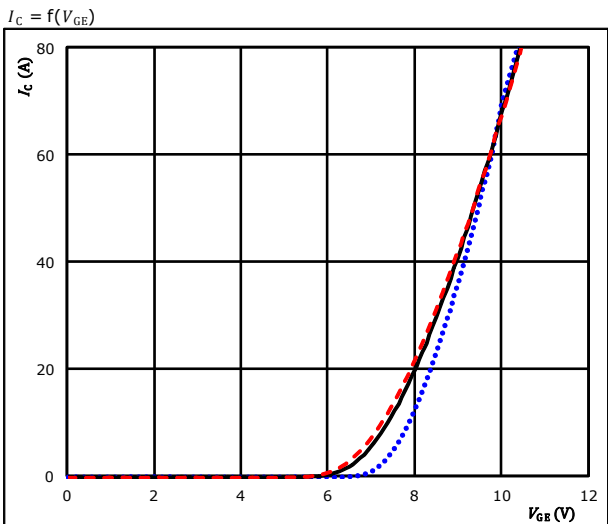

Transient Thermal Impedance as function of Pulse duration IGBT

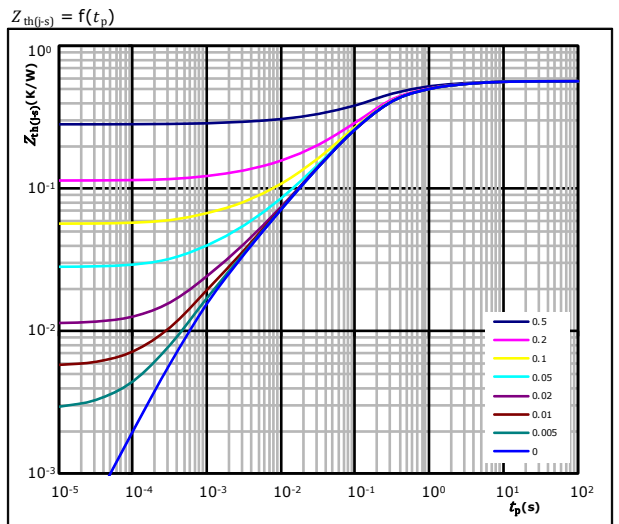

$D = t_p / T$
 $R_{th(j-s)} = 0,57 \text{ K/W}$

IGBT thermal model values

R (K/W)	τ (s)
3,82E-02	4,84E+00
1,01E-01	9,05E-01
3,13E-01	1,69E-01
7,11E-02	3,95E-02
3,50E-02	8,21E-03
1,29E-02	9,97E-04



Vincotech

10-FY124PA080SH-L589F48
10-PY124PA080SH-L589F48Y
 datasheet

H-Bridge Switch Characteristics

Gate voltage vs Gate charge IGBT

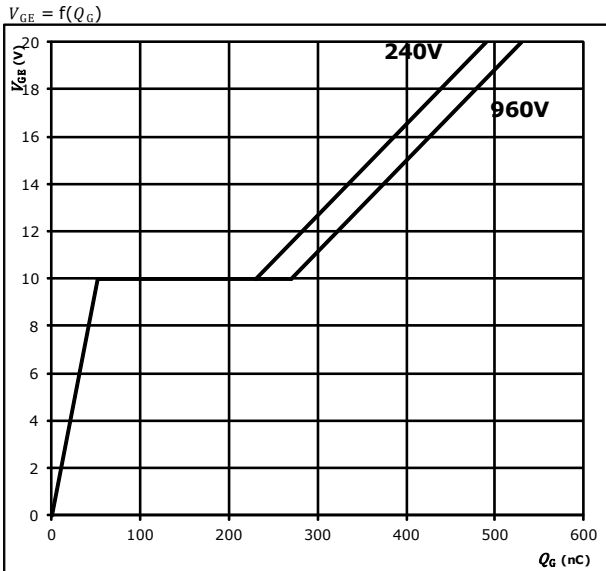

At
 $I_C = 80 \text{ A}$

Safe operating area IGBT

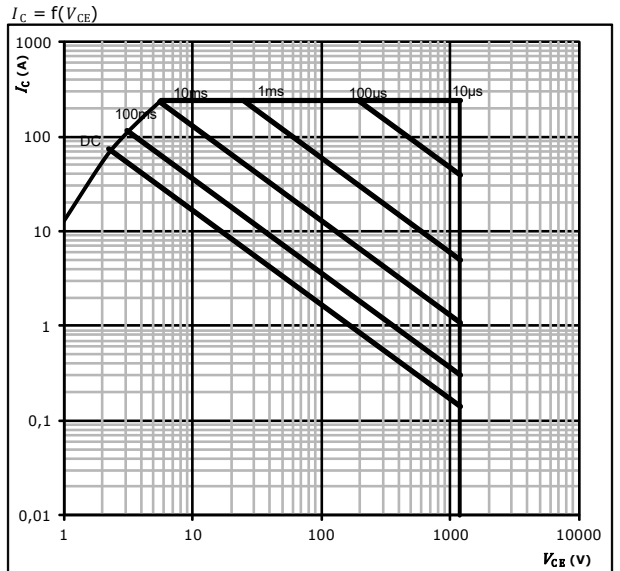

At
 $D = \text{single pulse}$
 $T_s = 80 \text{ }^\circ\text{C}$
 $V_{GE} = \pm 15 \text{ V}$
 $T_j = T_{jmax} \text{ }^\circ\text{C}$

Short circuit duration as a function of V_{GE} IGBT

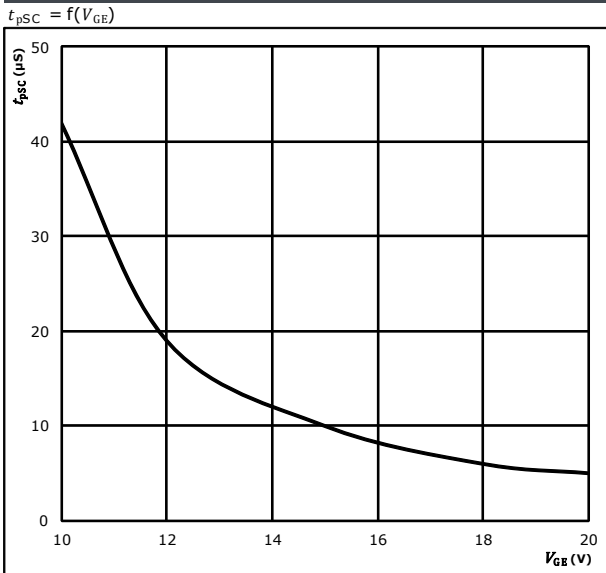

At
 $V_{CE} = 600 \text{ V}$
 $T_j \leq 150 \text{ }^\circ\text{C}$

Typical short circuit current as a function of V_{GE} IGBT

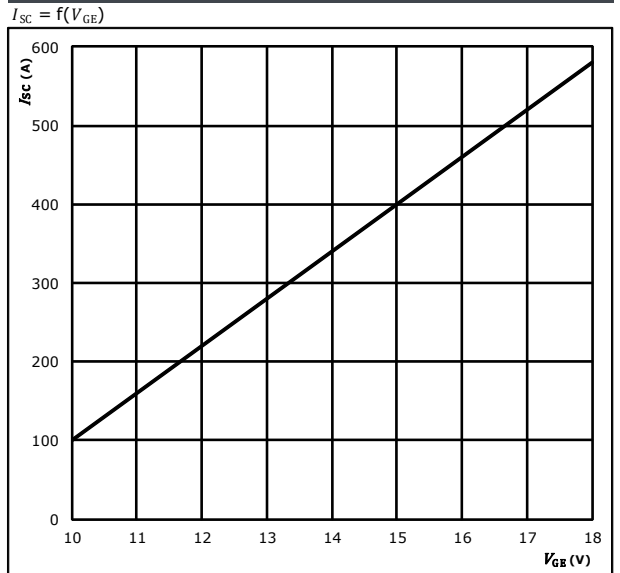

At
 $V_{CE} \leq 600 \text{ V}$
 $T_j \leq 25 \text{ }^\circ\text{C}$



Vincotech

H-Bridge Diode Characteristics

figure 1. FWD
Typical forward characteristics

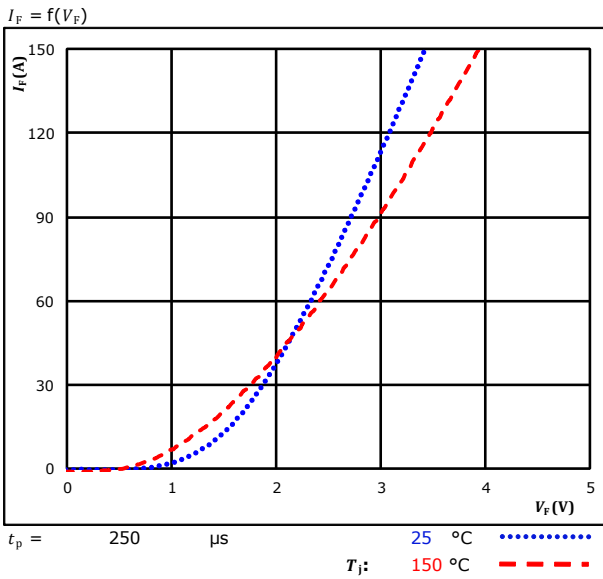
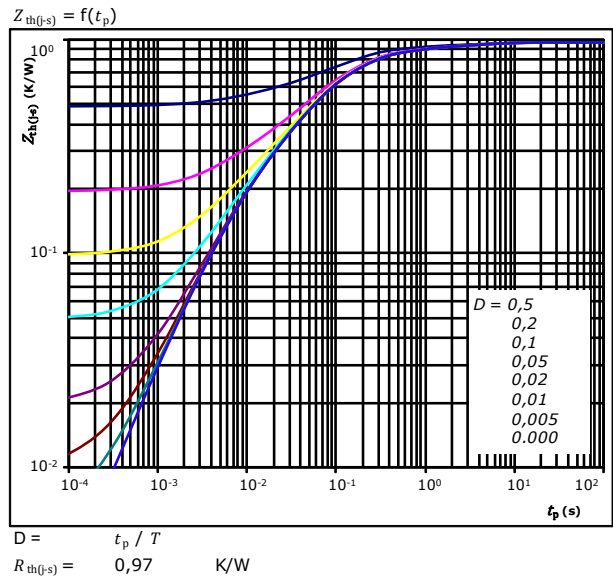

figure 2. FWD
Transient thermal impedance as a function of pulse width



FWD thermal model values

R (K/W)	τ (s)
6,6890E-02	3,8680E+00
1,4690E-01	4,6800E-01
4,9550E-01	9,1220E-02
1,7380E-01	2,2610E-02
8,7450E-02	5,0060E-03



Thermistor Characteristics

figure 1. Thermistor

**Typical NTC characteristic
as a function of temperature**

$$R = f(T)$$

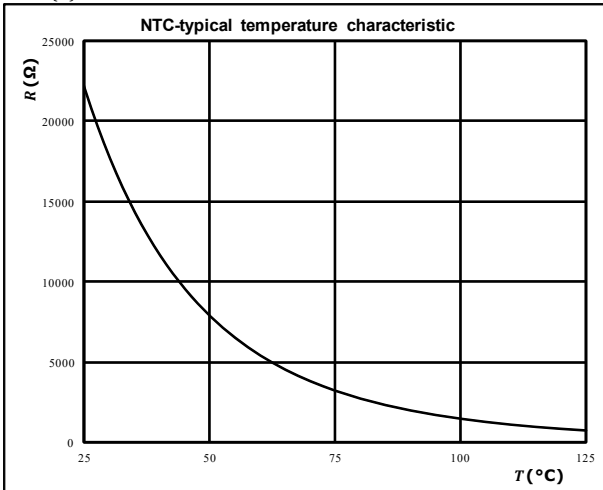



Vincotech

H-Bridge Switching Characteristics

figure 1. IGBT

Typical switching energy losses as a function of collector current

$$E = f(I_c)$$

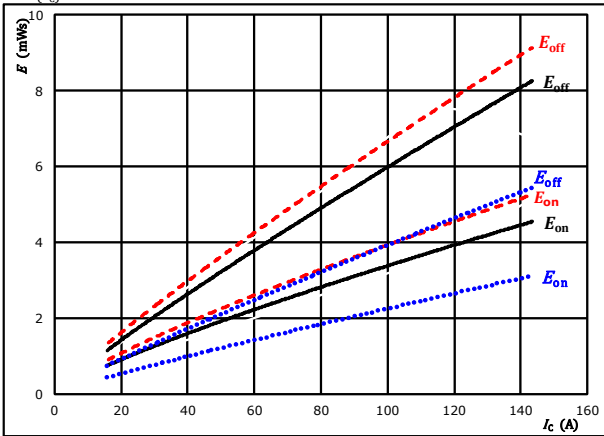

With an inductive load at

$V_{CE} = 600$ V
 $V_{GE} = \pm 15$ V
 $R_{g\text{on}} = 4$ Ω
 $R_{g\text{off}} = 4$ Ω

T_j : 25 °C (dotted)
 125 °C (solid)
 150 °C (dashed)

figure 2. IGBT

Typical switching energy losses as a function of gate resistor

$$E = f(R_g)$$

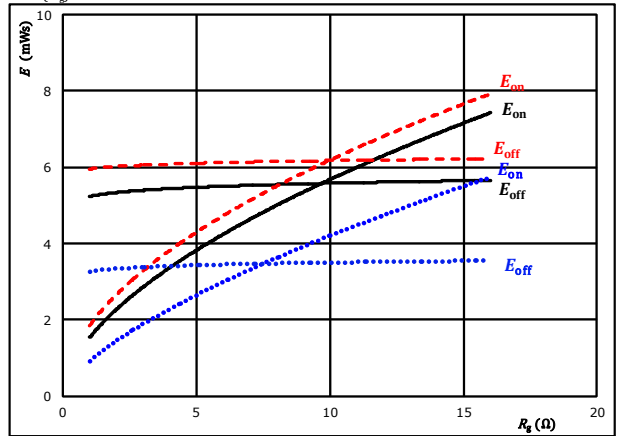

With an inductive load at

$V_{CE} = 600$ V
 $V_{GE} = \pm 15$ V
 $I_c = 80$ A

T_j : 25 °C (dotted)
 125 °C (solid)
 150 °C (dashed)

figure 3. FWD

Typical reverse recovered energy loss as a function of collector current

$$E_{rec} = f(I_c)$$

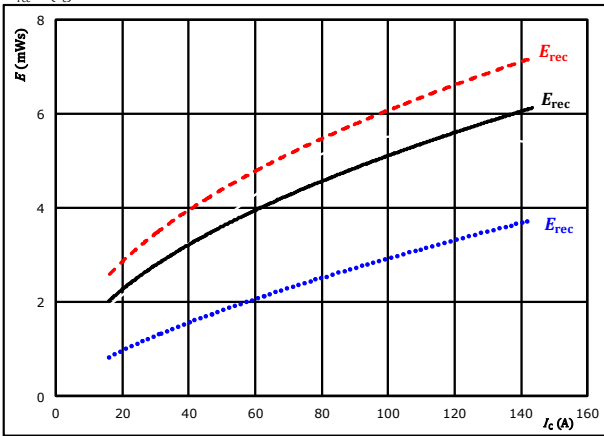

With an inductive load at

$V_{CE} = 600$ V
 $V_{GE} = \pm 15$ V
 $R_{g\text{on}} = 4$ Ω

T_j : 25 °C (dotted)
 125 °C (solid)
 150 °C (dashed)

figure 4. FWD

Typical reverse recovered energy loss as a function of gate resistor

$$E_{rec} = f(R_g)$$

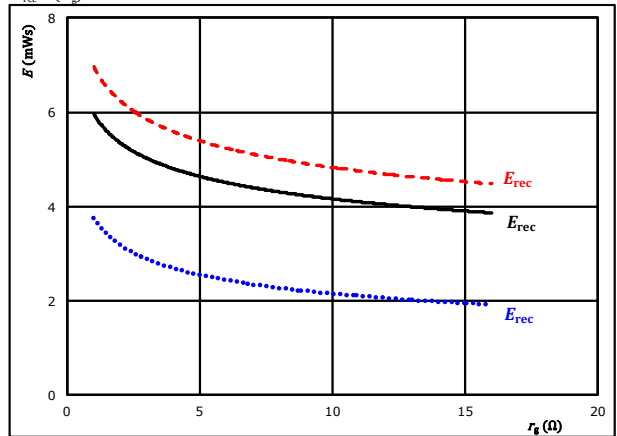

With an inductive load at

$V_{CE} = 600$ V
 $V_{GE} = \pm 15$ V
 $I_c = 80$ A

T_j : 25 °C (dotted)
 125 °C (solid)
 150 °C (dashed)



Vincotech

H-Bridge Switching Characteristics

figure 5. IGBT

Typical switching times as a function of collector current

$$t = f(I_C)$$

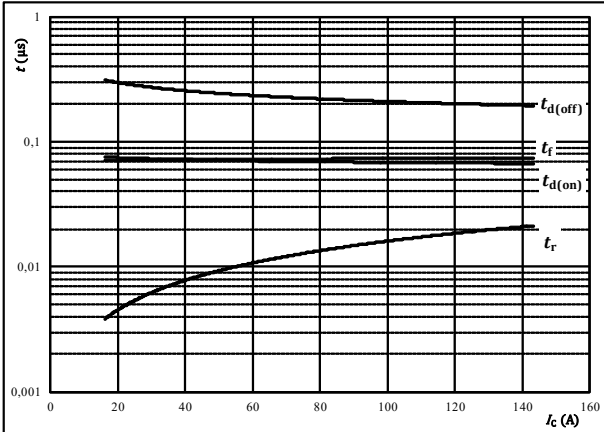

With an inductive load at

$T_j =$	150	°C
$V_{CE} =$	600	V
$V_{GE} =$	±15	V
$R_{gon} =$	4	Ω
$R_{goff} =$	4	Ω

figure 6. IGBT

Typical switching times as a function of gate resistor

$$t = f(R_g)$$

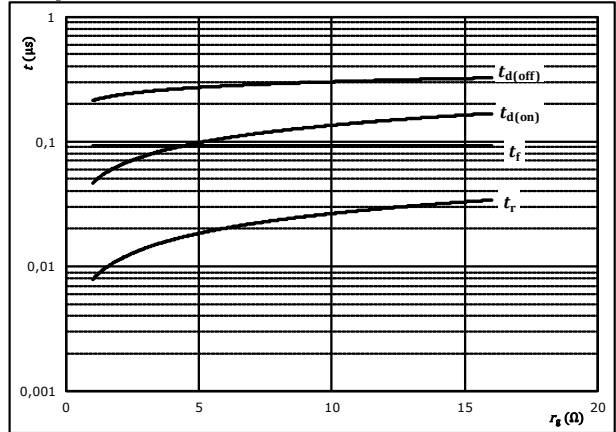

With an inductive load at

$T_j =$	150	°C
$V_{CE} =$	600	V
$V_{GE} =$	±15	V
$I_C =$	80	A

figure 7. FWD

Typical reverse recovery time as a function of collector current

$$t_{rr} = f(I_C)$$

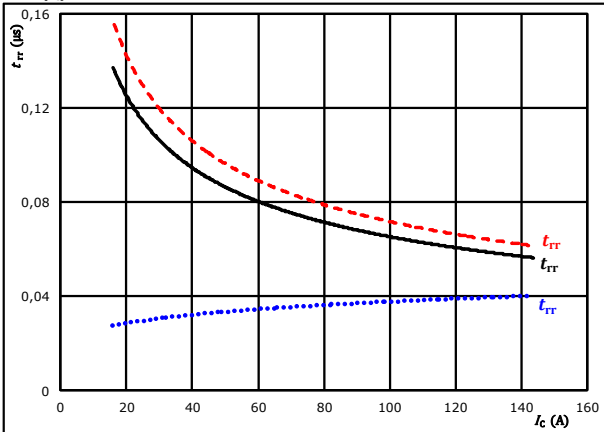

At	$V_{CE} =$	600	V	$T_j:$	25 °C
	$V_{GE} =$	±15	V		125 °C	————
	$R_{gon} =$	4	Ω		150 °C	-----

figure 8. FWD

Typical reverse recovery time as a function of IGBT turn on gate resistor

$$t_{rr} = f(R_{gon})$$

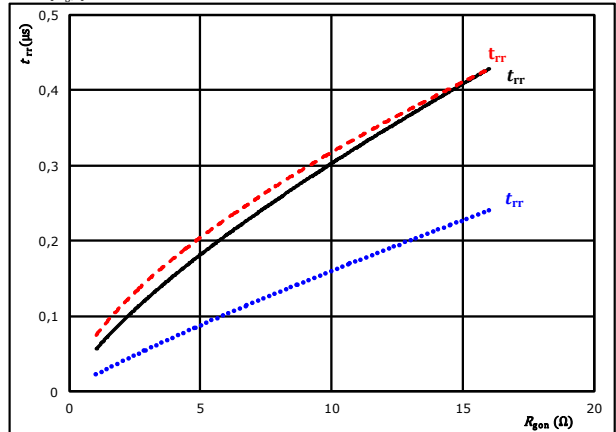

At	$V_{CE} =$	600	V	$T_j:$	25 °C
	$V_{GE} =$	±15	V		125 °C	————
	$I_C =$	80	A		150 °C	-----



H-Bridge Switching Characteristics

figure 9. FWD

Typical recovered charge as a function of collector current

$$Q_r = f(I_c)$$

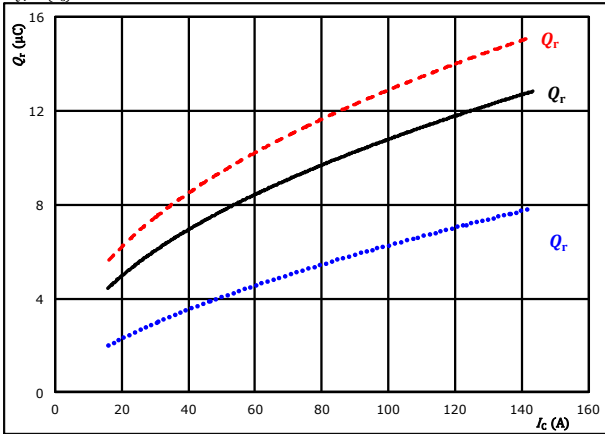

At $V_{CE} = 600$ V $T_j: 25$ °C (dotted blue)
 $V_{GE} = \pm 15$ V $T_j: 125$ °C (solid black)
 $R_{gpn} = 4$ Ω $T_j: 150$ °C (dashed red)

figure 10. FWD

Typical recovered charge as a function of IGBT turn on gate resistor

$$Q_r = f(R_{gpn})$$

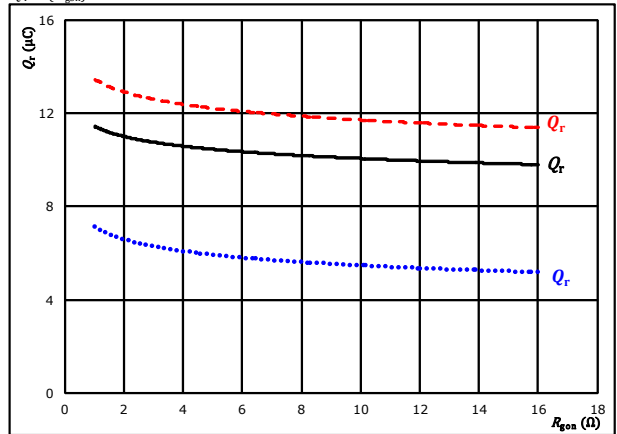

At $V_{CE} = 600$ V $T_j: 25$ °C (dotted blue)
 $V_{GE} = \pm 15$ V $T_j: 125$ °C (solid black)
 $I_c = 80$ A $T_j: 150$ °C (dashed red)

figure 11. FWD

Typical peak reverse recovery current current as a function of collector current

$$I_{RM} = f(I_c)$$

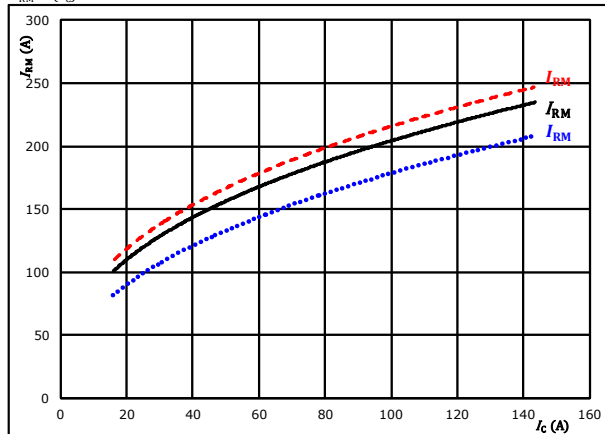

At $V_{CE} = 600$ V $T_j: 25$ °C (dotted blue)
 $V_{GE} = \pm 15$ V $T_j: 125$ °C (solid black)
 $R_{gpn} = 4$ Ω $T_j: 150$ °C (dashed red)

figure 12. FWD

Typical peak reverse recovery current as a function of IGBT turn on gate resistor

$$I_{RM} = f(R_{gpn})$$

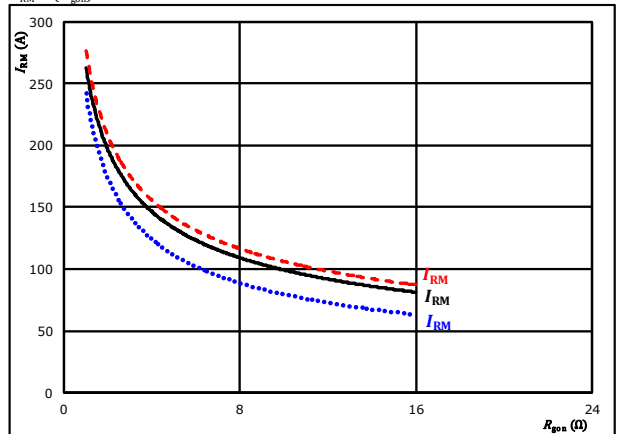

At $V_{CE} = 600$ V $T_j: 25$ °C (dotted blue)
 $V_{GE} = \pm 15$ V $T_j: 125$ °C (solid black)
 $I_c = 80$ A $T_j: 150$ °C (dashed red)



Vincotech

H-Bridge Switching Characteristics

figure 13. FWD

Typical rate of fall of forward and reverse recovery current as a function of collector current
 $di_f/dt, di_{rr}/dt = f(I_c)$

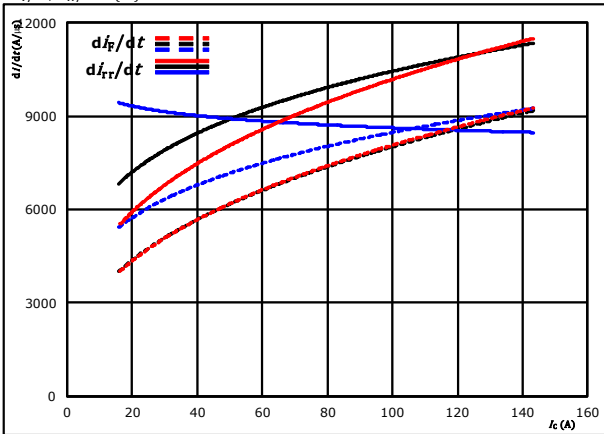

At $V_{CE} = 600$ V $T_j = 25$ °C
 $V_{GE} = \pm 15$ V $T_j = 125$ °C ———
 $R_{gon} = 4$ Ω $T_j = 150$ °C - - - - -

figure 14. FWD

Typical rate of fall of forward and reverse recovery current as a function of IGBT turn on gate resistor
 $di_f/dt, di_{rr}/dt = f(R_g)$

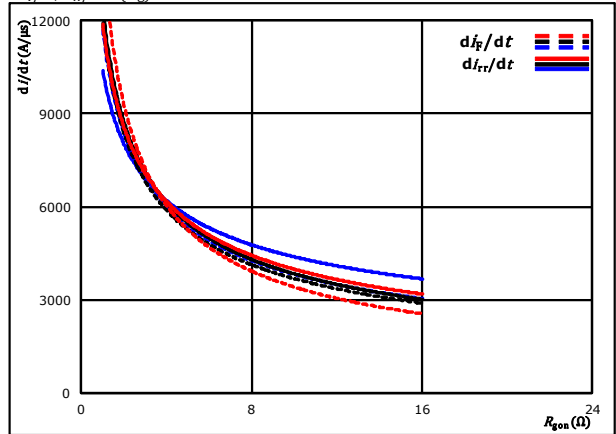

At $V_{CE} = 600$ V $T_j = 25$ °C
 $V_{GE} = \pm 15$ V $T_j = 125$ °C ———
 $I_c = 80$ A $T_j = 150$ °C - - - - -

figure 15. IGBT

Reverse bias safe operating area
 $I_c = f(V_{CB})$

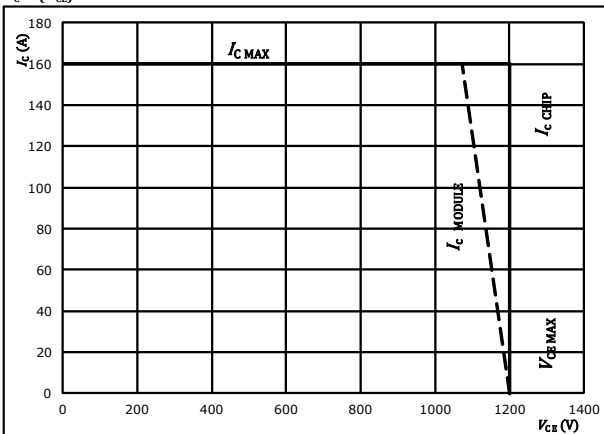

At $T_j = 175$ °C
 $R_{gon} = 4$ Ω
 $R_{goff} = 4$ Ω



Vincotech

H-Bridge Switching Definitions

General conditions

T_j	=	125 °C
R_{gon}	=	4 Ω
R_{goff}	=	4 Ω

figure 1. IGBT

Turn-off Switching Waveforms & definition of t_{doff} , t_{Eoff} (t_{Eoff} = integrating time for E_{off})

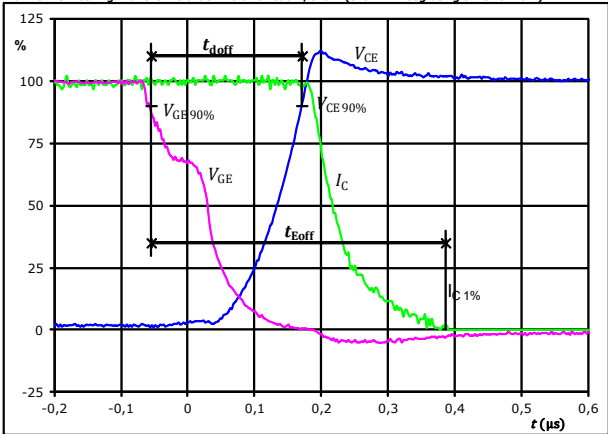

$V_{CE}(0\%) =$	-15	V
$V_{GE}(100\%) =$	15	V
$V_C(100\%) =$	600	V
$I_C(100\%) =$	80	A
$t_{doff} =$	0,233	μs
$t_{Eoff} =$	0,441	μs

figure 2. IGBT

Turn-on Switching Waveforms & definition of t_{don} , t_{Eon} (t_{Eon} = integrating time for E_{on})

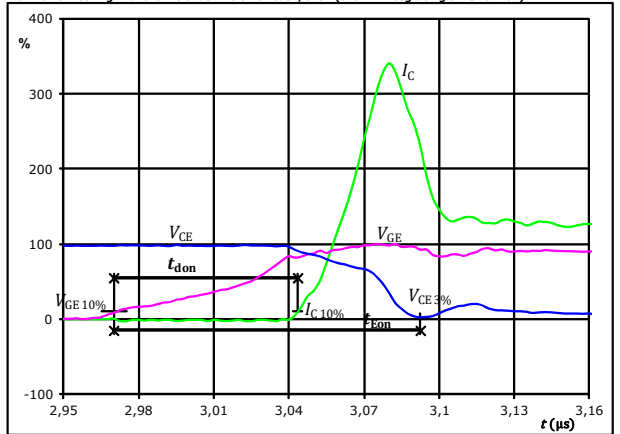

$V_{CE}(0\%) =$	-15	V
$V_{GE}(100\%) =$	15	V
$V_C(100\%) =$	600	V
$I_C(100\%) =$	80	A
$t_{don} =$	0,073	μs
$t_{Eon} =$	0,122	μs

figure 3. IGBT

Turn-off Switching Waveforms & definition of t_f

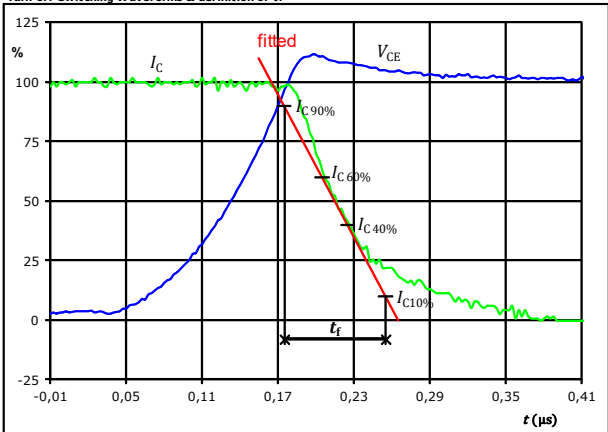

$V_C(100\%) =$	600	V
$I_C(100\%) =$	80	A
$t_f =$	0,078	μs

figure 4. IGBT

Turn-on Switching Waveforms & definition of t_r

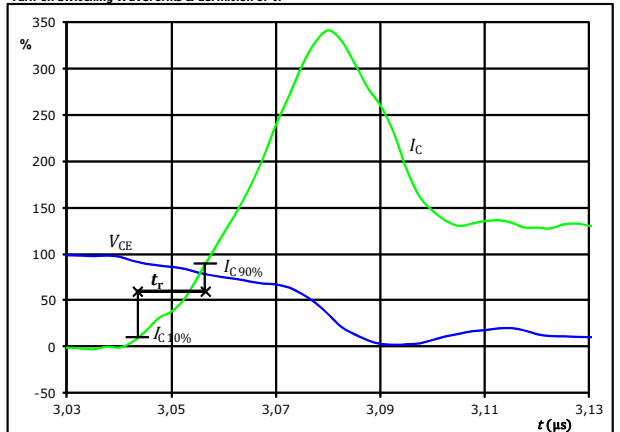

$V_C(100\%) =$	600	V
$I_C(100\%) =$	80	A
$t_r =$	0,013	μs



Vincotech

10-FY124PA080SH-L589F48
10-PY124PA080SH-L589F48Y
 datasheet

H-Bridge Switching Characteristics

figure 5. IGBT

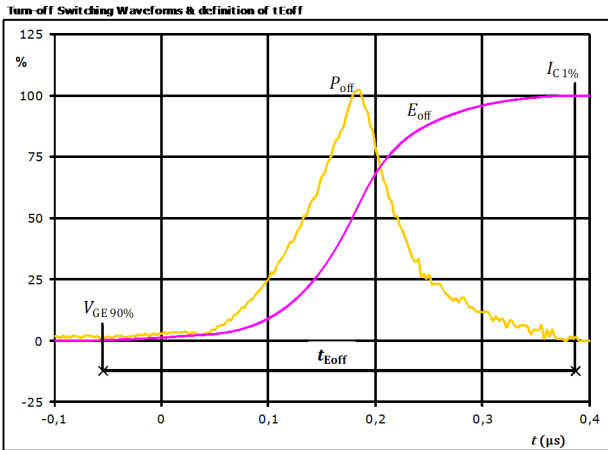

$P_{off}(100\%) = 48,22$ kW
 $E_{off}(100\%) = 5,38$ mJ
 $t_{Eoff} = 0,44$ μ s

figure 6. IGBT

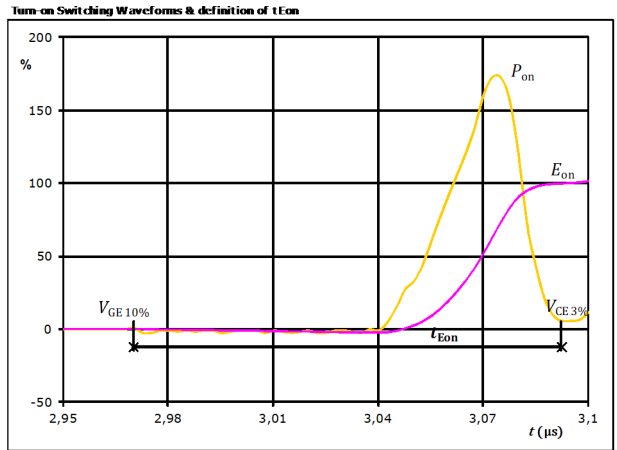

$P_{on}(100\%) = 48,22$ kW
 $E_{on}(100\%) = 2,63$ mJ
 $t_{Eon} = 0,12$ μ s

figure 7. FWD

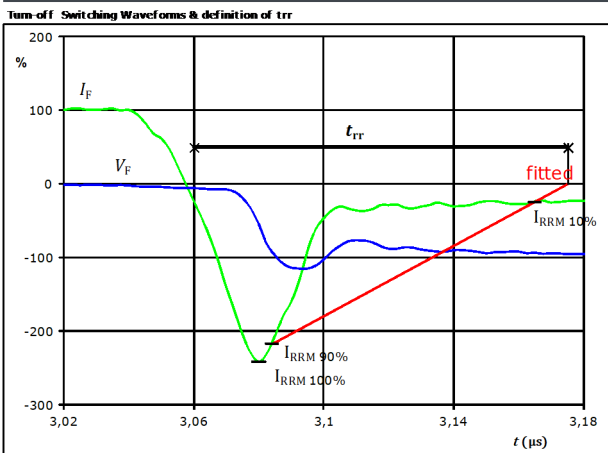

$V_F(100\%) = 600$ V
 $I_F(100\%) = 80$ A
 $I_{RRM}(100\%) = -194$ A
 $t_{rr} = 0,101$ μ s



Vincotech

10-FY124PA080SH-L589F48
10-PY124PA080SH-L589F48Y
 datasheet

H-Bridge Switching Characteristics

figure 8. FWD

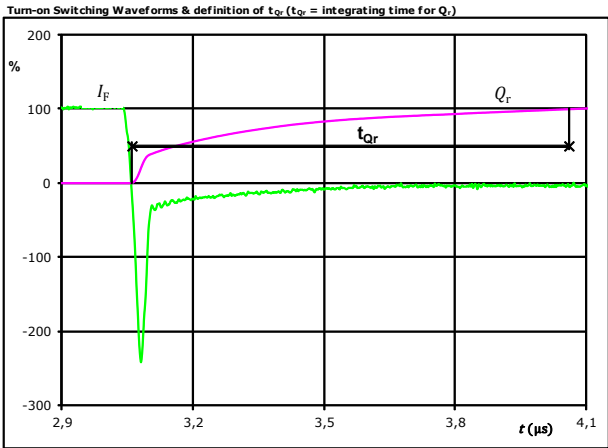

I_F (100%) =	80	A
Q_r (100%) =	10,71	μC
t_{Qr} =	1,00	μs

figure 9. FWD

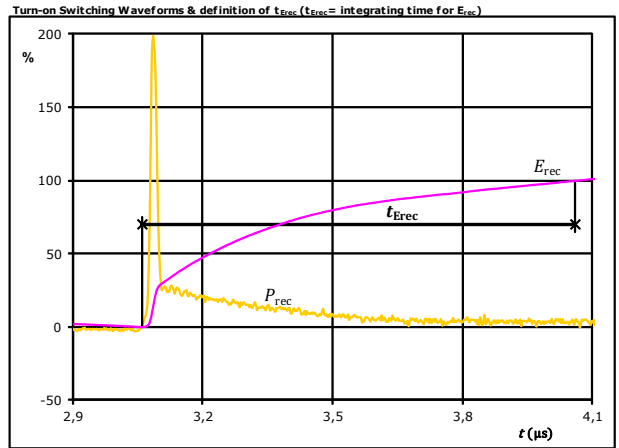

P_{rec} (100%) =	48,22	kW
E_{rec} (100%) =	5,17	mJ
t_{Erec} =	1,00	μs



Vincotech

Ordering Code & Marking							
Version				Ordering Code			
without thermal paste 12 mm housing with solder pins				10-FY124PA080SH-L589F48			
without thermal paste 12 mm housing with press-fit pins				10-PY124PA080SH-L589F48Y			
with thermal paste 12 mm housing with solder pins				10-FY124PA080SH-L589F48-/3/			
with thermal paste 12 mm housing with press-fit pins				10-PY124PA080SH-L589F48Y-/3/			
	Text	Name		Date code	UL & VIN	Lot	Serial
		NN-NNNNNNNNNNNNNN-TTTTTWW		WWYY	UL VIN	LLLLL	SSSS
		Datamatrix	Type&Ver	Lot number	Serial	Date code	
		TTTTTTVV	LLLLL	SSSS	WWYY		

Outline							
Pin table [mm]				Pin table [mm]			
Pin	X	Y	Function	Pin	X	Y	Function
1			Not assembled	30	34,35	28,6	S14
2	46,3	0	DC-2	31	37,35	28,6	G14-a
3	43,6	2,7	DC-2	32	41,8	28,6	Ph2
4	43,6	0	DC-2	33	44,5	28,6	Ph2
5	39,2	1	G13-a	34	47,2	28,6	Ph2
6	36,2	0	S13	35	49,9	28,6	Ph2
7	33,2	1	G13-b	36	52,6	28,6	Ph2
8	28,8	0	Therm2	37	52,6	14,9	DC+
9	23,8	0	Therm1	38	52,6	12,2	DC+
10	19,4	1	G11-b	39	52,6	9,5	DC+
11	16,4	0	S11	40			Not assembled
12	13,4	1	G11-a				
13	9	2,7	DC-1				
14	9	0	DC-1				
15			Not assembled				
16	6,3	0	DC-1				
17			Not assembled				
18	0	9,5	DC+				
19	0	12,2	DC+				
20	0	14,9	DC+				
21	0	28,6	Ph1				
22	2,7	28,6	Ph1				
23	5,4	28,6	Ph1				
24	8,1	28,6	Ph1				
25	10,8	28,6	Ph1				
26	15,25	28,6	G12-a				
27	18,25	28,6	S12				
28	21,25	28,6	G12-b				
29	31,35	28,6	G14-b				

Tolerance of pinpositions: ±0,5mm at the end of pins
 Dimension of coordinate axis is only offset without tolerance



Vincotech

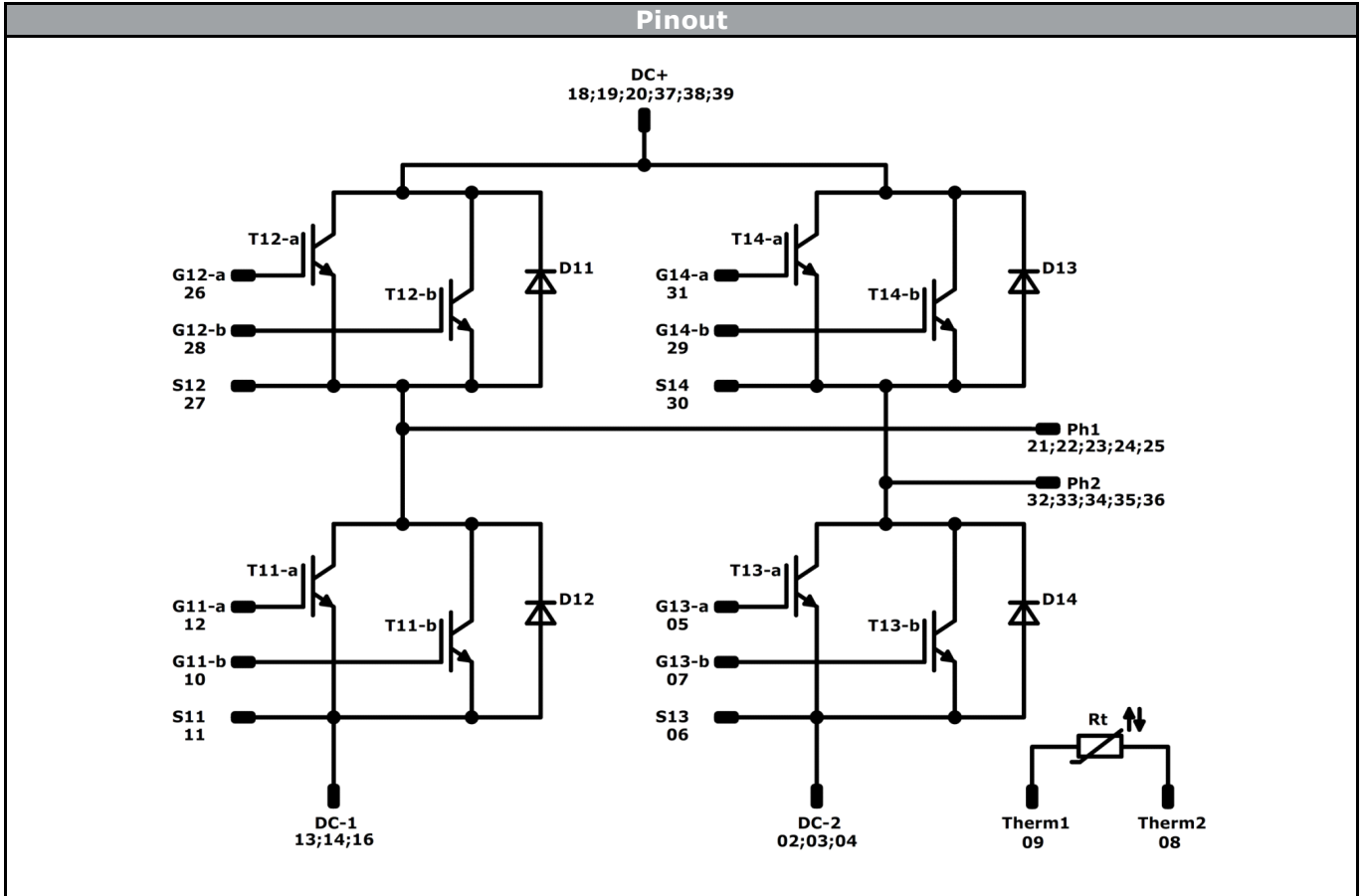

Identification					
ID	Component	Voltage	Current	Function	Comment
T11a, T11b, T12a, T12b, T13a, T13b, T14a, T14b	IGBT	1200 V	80 A	H-Bridge Switch	Parallel devices with separate control. Values apply to complete device.
D11, D12, D13, D14	FWD	1200 V	50 A	H-Bridge Diode	
Rt	Thermistor			Thermistor	



Vincotech

Packaging instruction			
Standard packaging quantity (SPQ) 100	>SPQ	Standard	<SPQ Sample

Handling instruction
Handling instructions for <i>flow 1</i> packages see vincotech.com website.

Package data
Package data for <i>flow 1</i> packages see vincotech.com website.

UL recognition and file number
This device is certified according to UL 1557 standard, UL file number E192116. For more information see vincotech.com website. 

Document No.:	Date:	Modification:	Pages
10-xY124PA080SH-L589F48x-D3-14	30 Aug. 2017	Added thermal paste options to ordering code	16

DISCLAIMER

The information, specifications, procedures, methods and recommendations herein (together "information") are presented by Vincotech to reader in good faith, are believed to be accurate and reliable, but may well be incomplete and/or not applicable to all conditions or situations that may exist or occur. Vincotech reserves the right to make any changes without further notice to any products to improve reliability, function or design. No representation, guarantee or warranty is made to reader as to the accuracy, reliability or completeness of said information or that the application or use of any of the same will avoid hazards, accidents, losses, damages or injury of any kind to persons or property or that the same will not infringe third parties rights or give desired results. It is reader's sole responsibility to test and determine the suitability of the information and the product for reader's intended use.

LIFE SUPPORT POLICY

Vincotech products are not authorised for use as critical components in life support devices or systems without the express written approval of Vincotech.

As used herein:

1. Life support devices or systems are devices or systems which, (a) are intended for surgical implant into the body, or (b) support or sustain life, or (c) whose failure to perform when properly used in accordance with instructions for use provided in labelling can be reasonably expected to result in significant injury to the user.
2. A critical component is any component of a life support device or system whose failure to perform can be reasonably expected to cause the failure of the life support device or system, or to affect its safety or effectiveness.

单击下面可查看定价，库存，交付和生命周期等信息

[>>Vincotech\(威科\)](#)