







Vincotech

10-xZ12PMA015M7-P840A28x
10-x012PMA015M7-P840A29x
 datasheet

<i>flow PIM 0</i>	1200 V / 15 A
<div style="background-color: #f0f0f0; padding: 5px; margin-bottom: 10px;">Features</div> <ul style="list-style-type: none"> IGBT M7 with low V_{CEsat} and improved EMC behavior Open emitter configuration Compact and low inductive design Built-in NTC 	<div style="background-color: #f0f0f0; padding: 5px; margin-bottom: 10px;">flow 0 housing</div> <div style="display: flex; justify-content: space-around;"> <div style="text-align: center;"> <p>12 mm</p>  </div> <div style="text-align: center;">  </div> </div> <div style="display: flex; justify-content: space-around;"> <div style="text-align: center;"> <p>17 mm</p>  </div> <div style="text-align: center;">  </div> </div> <p style="text-align: center; font-size: small;">Solder pin Press-fit pin</p>
<div style="background-color: #f0f0f0; padding: 5px; margin-bottom: 10px;">Target applications</div> <ul style="list-style-type: none"> Industrial Drives 	<div style="background-color: #f0f0f0; padding: 5px; margin-bottom: 10px;">Schematic</div> 
<div style="background-color: #f0f0f0; padding: 5px; margin-bottom: 10px;">Types</div> <ul style="list-style-type: none"> 10-FZ12PMA015M7-P840A28 10-F012PMA015M7-P840A29 10-PZ12PMA015M7-P840A28Y 10-P012PMA015M7-P840A29Y 	

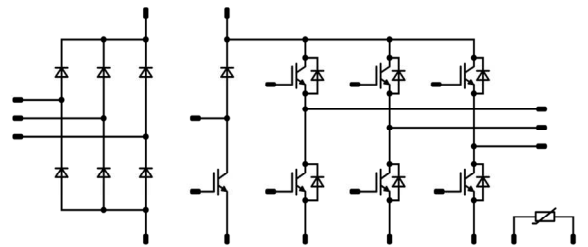
Maximum Ratings

$T_j = 25\text{ °C}$, unless otherwise specified

Parameter	Symbol	Condition	Value	Unit
Rectifier Diode				
Peak Repetitive Reverse Voltage	V_{RRM}		1600	V
Continuous (direct) forward current	I_F	$T_j = T_{jmax}$ $T_s = 80\text{ °C}$	25	A
Surge (non-repetitive) forward current	I_{FSM}	50 Hz Single Half Sine Wave $t_p = 10\text{ ms}$ $T_j = 150\text{ °C}$	200	A
Surge current capability	I^2t		200	A ² s
Total power dissipation	P_{tot}	$T_j = T_{jmax}$ $T_s = 80\text{ °C}$	44	W
Maximum Junction Temperature	T_{jmax}		150	°C



Vincotech

10-xZ12PMA015M7-P840A28x
10-x012PMA015M7-P840A29x
 datasheet

Maximum Ratings

$T_j = 25\text{ °C}$, unless otherwise specified

Parameter	Symbol	Condition	Value	Unit
Inverter Switch				
Collector-emitter voltage	V_{CES}		1200	V
Collector current	I_C	$T_j = T_{jmax}$ $T_s = 80\text{ °C}$	15	A
Repetitive peak collector current	I_{CRM}	t_p limited by T_{jmax}	30	A
Total power dissipation	P_{tot}	$T_j = T_{jmax}$ $T_s = 80\text{ °C}$	60	W
Gate-emitter voltage	V_{GES}		± 20	V
Maximum junction temperature	T_{jmax}		175	°C

Inverter Diode				
Peak repetitive reverse voltage	V_{RRM}		1200	V
Continuous (direct) forward current	I_F	$T_j = T_{jmax}$ $T_s = 80\text{ °C}$	15	A
Repetitive peak forward current	I_{FRM}		30	A
Total power dissipation	P_{tot}	$T_j = T_{jmax}$ $T_s = 80\text{ °C}$	45	W
Maximum junction temperature	T_{jmax}		175	°C

Brake Switch				
Collector-emitter voltage	V_{CES}		1200	V
Collector current	I_C	$T_j = T_{jmax}$ $T_s = 80\text{ °C}$	10	A
Repetitive peak collector current	I_{CRM}	t_p limited by T_{jmax}	20	A
Total power dissipation	P_{tot}	$T_j = T_{jmax}$ $T_s = 80\text{ °C}$	55	W
Gate-emitter voltage	V_{GES}		± 20	V
Maximum junction temperature	T_{jmax}		175	°C

Brake Diode				
Peak repetitive reverse voltage	V_{RRM}		1200	V
Continuous (direct) forward current	I_F	$T_j = T_{jmax}$ $T_s = 80\text{ °C}$	5	A
Repetitive peak forward current	I_{FRM}		10	A
Total power dissipation	P_{tot}	$T_j = T_{jmax}$ $T_s = 80\text{ °C}$	27	W
Maximum junction temperature	T_{jmax}		175	°C



Maximum Ratings

$T_j = 25\text{ °C}$, unless otherwise specified

Parameter	Symbol	Condition	Value	Unit
-----------	--------	-----------	-------	------

Module Properties

Thermal Properties

Storage temperature	T_{stg}		-40...+125	°C
Operation temperature under switching condition	T_{top}		-40...(T _{max} - 25)	°C

Isolation Properties

Isolation voltage	V_{isol}	DC Test Voltage* $t_p = 2\text{ s}$	6000	V
		AC Voltage $t_p = 1\text{ min}$	2500	V
Creepage distance			min. 12,7	mm
Clearance		Solder pin 12 mm housing / 17 mm housing	9,29 / 12,7	mm
		Press-fit pin 12 mm housing / 17 mm housing	9,48 / 12,7	
Comparative Tracking Index	CTI		> 200	

*100 % tested in production



Characteristic Values

Parameter	Symbol	Conditions					Value			Unit
		V_{GS} [V]	V_{GE} [V]	V_{DS} [V]	I_C [A]	T_j [°C]	Min	Typ	Max	

Rectifier Diode

Static

Forward voltage	V_F				25	25 125		1,22 1,21	1,8	V
Reverse leakage current	I_r			1600		25 145			50 1100	μ A

Thermal

Thermal resistance junction to sink	$R_{th(j-s)}$	$\lambda_{paste} = 3,4$ W/mK (PSX)						1,59		K/W
-------------------------------------	---------------	------------------------------------	--	--	--	--	--	------	--	-----

Inverter Switch

Static

Gate-emitter threshold voltage	$V_{GE(th)}$	$V_{GE} = V_{CE}$			0,0015	25		5,4	6	6,6	V
Collector-emitter saturation voltage	V_{CESat}		15		15	25 125 150			1,70 1,95 2,01	2,15	V
Collector-emitter cut-off current	I_{CES}		0	1200		25				60	μ A
Gate-emitter leakage current	I_{GES}		20	0		25				500	nA
Internal gate resistance	r_g								none		Ω
Input capacitance	C_{ies}								2900		pF
Output capacitance	C_{oes}		0	10		25			120		
Reverse transfer capacitance	C_{res}								34		
Gate charge	Q_g		15	600	15	25			110		nC

Thermal

Thermal resistance junction to sink	$R_{th(j-s)}$	$\lambda_{paste} = 3,4$ W/mK (PSX)							1,60		K/W
-------------------------------------	---------------	------------------------------------	--	--	--	--	--	--	------	--	-----

Dynamic

Turn-on delay time	$t_{d(on)}$					25 150			176 174		ns
Rise time	t_r	$R_{goff} = 32 \Omega$ $R_{gon} = 32 \Omega$				25 150			43 48		
Turn-off delay time	$t_{d(off)}$		± 15	600	15	25 150			191 218		
Fall time	t_f					25 150			119 127		
Turn-on energy (per pulse)	E_{on}	$Q_{tFWD} = 1,5 \mu$ C $Q_{tFWD} = 2,6 \mu$ C				25 150			1,548 2,008		
Turn-off energy (per pulse)	E_{off}					25 150			0,925 1,322		mWs



Characteristic Values

Parameter	Symbol	Conditions					Value			Unit
		V_{GE} [V]	V_{CE} [V]	I_C [A]	T_j [°C]	Min	Typ	Max		

Inverter Diode

Static

Parameter	Symbol	V_{GE} [V]	V_{CE} [V]	I_C [A]	T_j [°C]	Min	Typ	Max	Unit
Forward voltage	V_F			15	25 125		1,63 1,74	2,1	V
Reverse leakage current	I_R		1200		25			30	µA

Thermal

Parameter	Symbol	Conditions	Value	Unit
Thermal resistance junction to sink	$R_{th(j-s)}$	$\lambda_{paste} = 3,4$ W/mK (PSX)	2,11	K/W

Dynamic

Parameter	Symbol	di/dt	\pm	I_C	I_F	T_j [°C]	Min	Typ	Max	Unit
Peak recovery current	I_{RRM}	$di/dt = 293$ A/µs $di/dt = 244$ A/µs	± 15	600	15	25		11		A
Reverse recovery time	t_{rr}					150		12		ns
Recovered charge	Q_r					25		265		µC
Reverse recovered energy	E_{rec}					150		423		mWs
Peak rate of fall of recovery current	$(di_{rr}/dt)_{max}$					25		0,488		A/µs
		150		0,938						



Vincotech

10-xZ12PMA015M7-P840A28x
10-x012PMA015M7-P840A29x
 datasheet

Characteristic Values

Parameter	Symbol	Conditions					Value			Unit
		V_{GS} [V]	V_{GE} [V]	V_{DS} [V]	I_D [A]	T_j [°C]	Min	Typ	Max	

Brake Switch

Static

Parameter	Symbol	$V_{GE} = V_{CE}$	V_{GS} [V]	V_{CE} [V]	I_D [A]	T_j [°C]	Min	Typ	Max	Unit
Gate-emitter threshold voltage	$V_{GE(th)}$				0,001	25	5,4	6	6,6	V
Collector-emitter saturation voltage	V_{CEsat}		15		10	25 125 150		1,66 1,90 1,96	2,15	V
Collector-emitter cut-off current	I_{CES}		0	1200		25			35	µA
Gate-emitter leakage current	I_{GES}		20	0		25			500	nA
Internal gate resistance	r_g							none		Ω
Input capacitance	C_{ies}							2000		pF
Output capacitance	C_{oes}		0	10		25		86		
Reverse transfer capacitance	C_{res}							23		
Gate charge	Q_g		15	600	10	25		80		nC

Thermal

Parameter	Symbol	Value	Unit
Thermal resistance junction to sink	$R_{th(j-s)}$	$\lambda_{paste} = 3,4 \text{ W/mK}$ (PSX)	K/W

Dynamic

Parameter	Symbol	R_{gon}	R_{goff}	I_D [A]	T_j [°C]	Min	Typ	Max	Unit
Turn-on delay time	$t_{d(on)}$	$R_{gon} = 64 \Omega$ $R_{goff} = 64 \Omega$		15/0	700	10	25	124	ns
Rise time	t_r						125	115	
							150	112	
							25	66	
Turn-off delay time	$t_{d(off)}$						125	73	
							150	74	
							25	353	
Fall time	t_f						125	386	
							150	395	
		25	94						
Turn-on energy (per pulse)	E_{on}						25	1,265	mWs
							125	1,536	
							150	1,581	
Turn-off energy (per pulse)	E_{off}						25	0,822	
							125	1,087	
							150	1,140	



Characteristic Values

Parameter	Symbol	Conditions					Value			Unit
		V_{GE} [V]	V_{CE} [V]	I_C [A]	T_j [°C]	Min	Typ	Max		
		V_{GS} [V]	V_{DS} [V]	I_D [A]	I_F [A]					
Brake Diode										
Static										
Forward voltage	V_F			5		25 125		1,57 1,65	2,1	V
Reverse leakage current	I_R		1200			25			20	μA
Thermal										
Thermal resistance junction to sink	$R_{th(j-s)}$	$\lambda_{paste} = 3,4$ W/mK (PSX)						3,50		K/W
Dynamic										
Peak recovery current	I_{RRM}					25 125 150		5 5 5		A
Reverse recovery time	t_{rr}					25 125 150		291 419 463		ns
Recovered charge	Q_r	$di/dt = 118$ A/μs $di/dt = 104$ A/μs $di/dt = 106$ A/μs	15/0	700	10	25 125 150		0,761 1,136 1,275		μC
Reverse recovered energy	E_{rec}					25 125 150		0,296 0,483 0,557		mWs
Peak rate of fall of recovery current	$(di_{rf}/dt)_{max}$					25 125 150		25 19 19		A/μs
Thermistor										
Rated resistance	R					25		22		kΩ
Deviation of R_{100}	$\Delta_{R/R}$	$R_{100} = 1484$ Ω				100	-5		5	%
Power dissipation	P					25		5		mW
Power dissipation constant						25		1,5		mW/K
B-value	$B_{(25/50)}$	Tol. ±1 %				25		3962		K
B-value	$B_{(25/100)}$	Tol. ±1 %				25		4000		K
Vincotech NTC Reference									I	



Rectifier Diode Characteristics

figure 1. FWD
 Typical forward characteristics

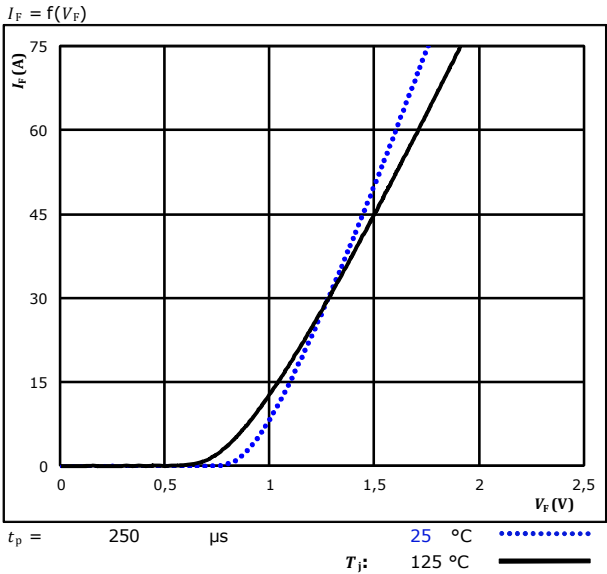
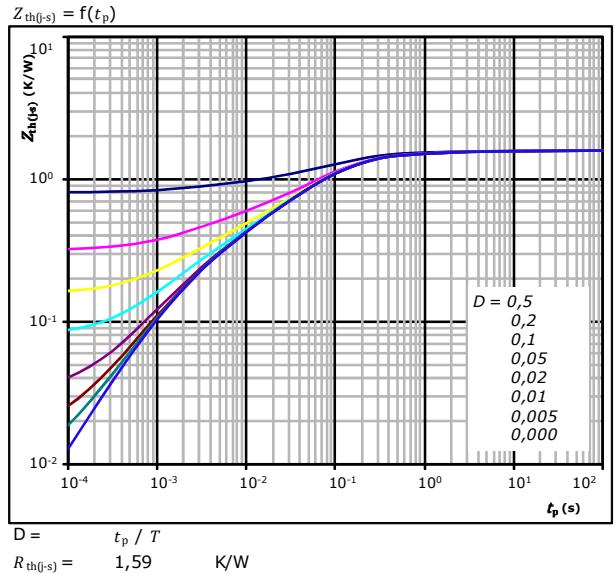

figure 2. FWD
 Transient thermal impedance as a function of pulse width



Diode thermal model values

R (K/W)	τ (s)
3,44E-02	9,66E+00
1,12E-01	1,22E+00
5,81E-01	1,45E-01
4,89E-01	5,05E-02
2,38E-01	9,26E-03
1,22E-01	1,79E-03
1,22E-01	1,79E-03



Inverter Switch Characteristics

figure 1. IGBT

Typical output characteristics

$I_C = f(V_{CE})$

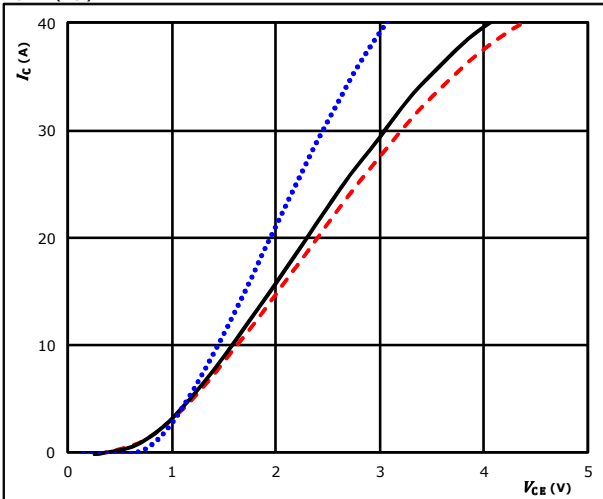

$t_p = 250 \mu s$ $T_j: 25 \text{ }^\circ C$
 $V_{GE} = 15 \text{ V}$ $T_j: 125 \text{ }^\circ C$ ———
 $T_j: 150 \text{ }^\circ C$ - - - -

figure 2. IGBT

Typical output characteristics

$I_C = f(V_{CE})$

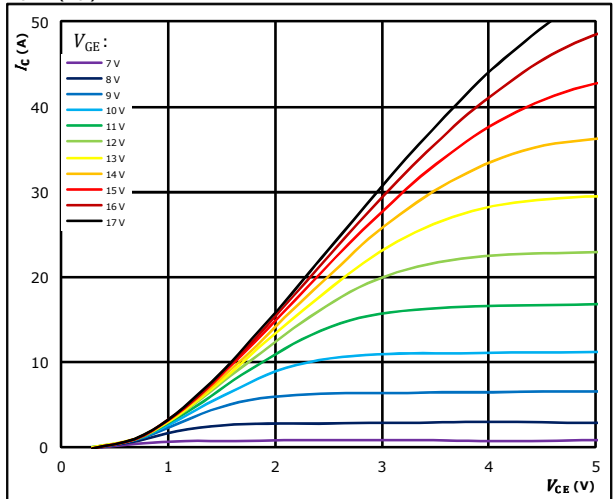

$t_p = 250 \mu s$
 $T_j = 150 \text{ }^\circ C$
 V_{GE} from 7 V to 17 V in steps of 1 V

figure 3. IGBT

Typical transfer characteristics

$I_C = f(V_{GE})$

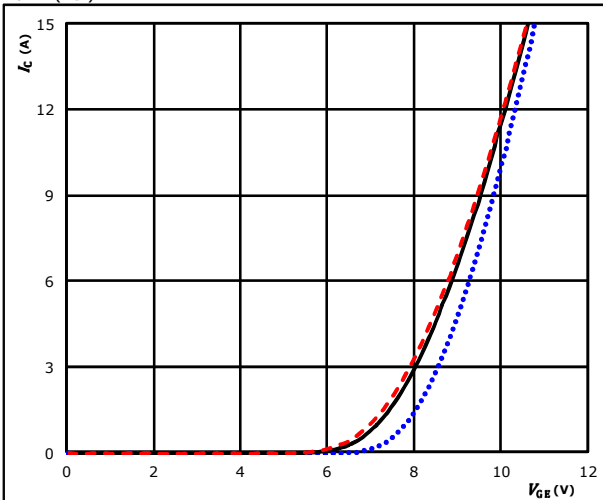

$t_p = 100 \mu s$ $T_j: 25 \text{ }^\circ C$
 $V_{CE} = 10 \text{ V}$ $T_j: 125 \text{ }^\circ C$ ———
 $T_j: 150 \text{ }^\circ C$ - - - -

figure 4. IGBT

Transient thermal impedance as function of pulse duration

$Z_{th(j-s)} = f(t_p)$

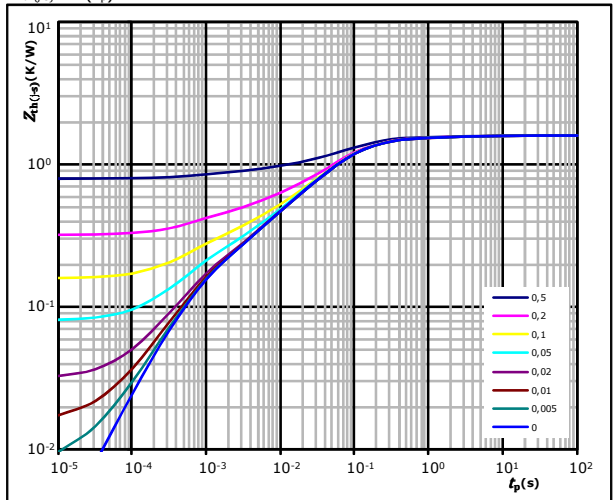

$D = t_p / T$
 $R_{th(j-s)} = 1,60 \text{ K/W}$
 IGBT thermal model values

$R \text{ (K/W)}$	$\tau \text{ (s)}$
4,90E-02	4,40E+00
1,40E-01	5,34E-01
8,04E-01	8,02E-02
2,98E-01	2,57E-02
1,69E-01	5,09E-03
1,35E-01	6,41E-04



Vincotech

Inverter Switch Characteristics

figure 5. IGBT

Safe operating area

$$I_C = f(V_{CE})$$

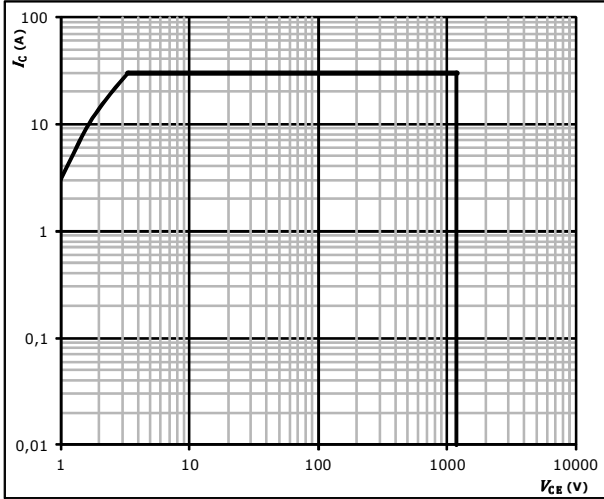

$D =$ single pulse
 $T_s =$ 80 °C
 $V_{GE} =$ ±15 V
 $T_j =$ T_{jmax}



Inverter Diode Characteristics

figure 1. **FWD**

Typical forward characteristics

$$I_F = f(V_F)$$

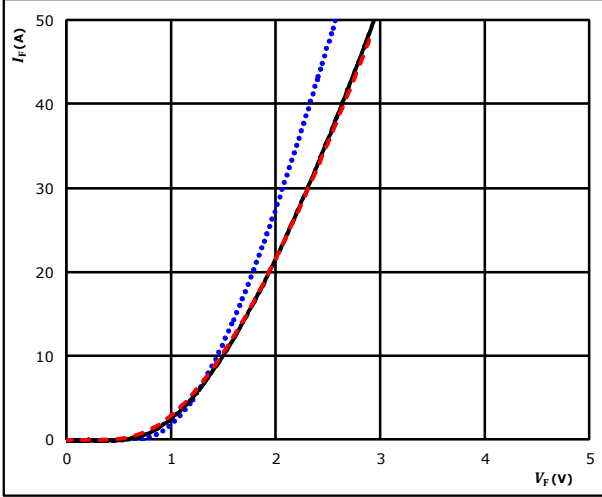

$t_p = 250 \mu s$

T_j : 25 °C
 125 °C ———
 150 °C - - - -

figure 2. **FWD**

Transient thermal impedance as a function of pulse width

$$Z_{th(j-s)} = f(t_p)$$

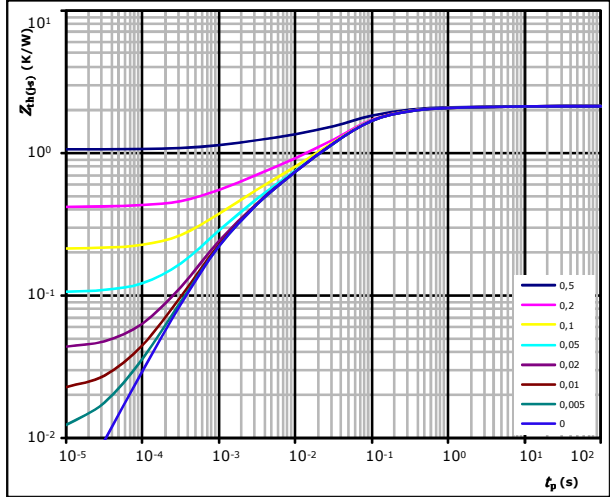

$D = t_p / T$

$R_{th(j-s)} = 2,11 \text{ K/W}$

FWD thermal model values

R (K/W)	τ (s)
8,99E-02	2,33E+00
4,04E-01	1,91E-01
1,05E+00	4,49E-02
3,39E-01	6,08E-03
2,29E-01	1,02E-03



Brake Switch Characteristics

figure 1. IGBT

Typical output characteristics

$I_C = f(V_{CE})$

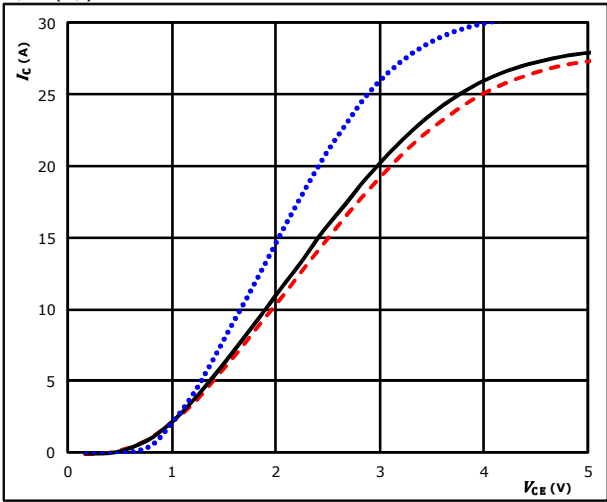

$t_p = 250 \mu s$ $T_j: 25 \text{ }^\circ C$
 $V_{GE} = 15 \text{ V}$ $T_j: 125 \text{ }^\circ C$ ———
 $T_j: 150 \text{ }^\circ C$ - - - -

figure 2. IGBT

Typical output characteristics

$I_C = f(V_{CE})$

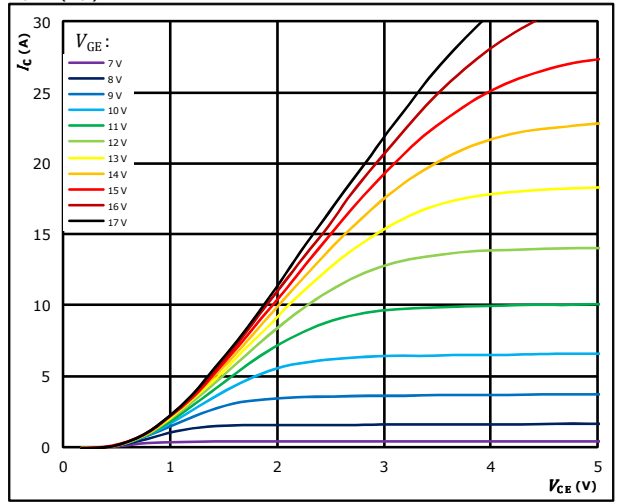

$t_p = 250 \mu s$ $T_j = 150 \text{ }^\circ C$
 V_{GE} from 7 V to 17 V in steps of 1 V

figure 3. IGBT

Typical transfer characteristics

$I_C = f(V_{GE})$

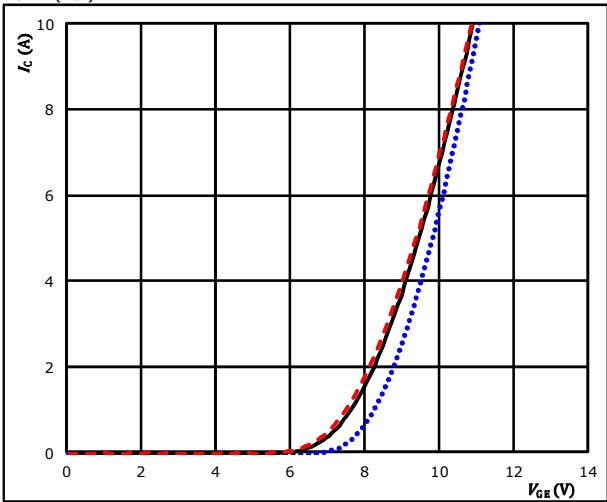

$t_p = 100 \mu s$ $T_j: 25 \text{ }^\circ C$
 $V_{CE} = 10 \text{ V}$ $T_j: 125 \text{ }^\circ C$ ———
 $T_j: 150 \text{ }^\circ C$ - - - -

figure 4. IGBT

Transient thermal impedance as function of pulse duration

$Z_{th(j-s)} = f(t_p)$

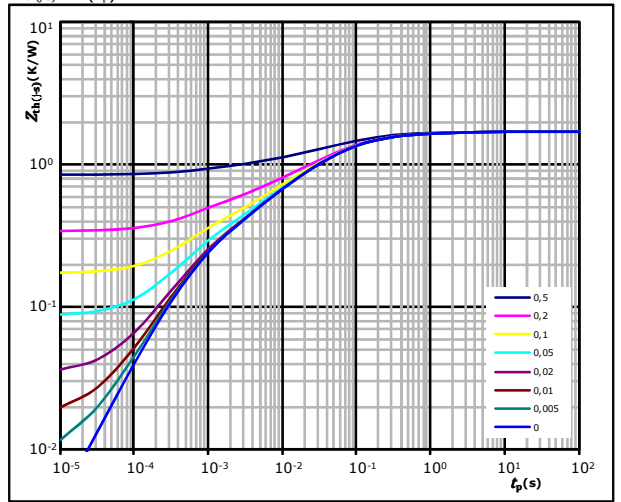

$D = t_p / T$
 $R_{th(j-s)} = 1,72 \text{ K/W}$
 IGBT thermal model values

R (K/W)	τ (s)
8,08E-02	2,32E+00
2,21E-01	2,45E-01
6,51E-01	6,03E-02
3,93E-01	1,33E-02
1,95E-01	3,15E-03
1,82E-01	5,45E-04



Brake Switch Characteristics

figure 5. IGBT

Safe operating area

$$I_C = f(V_{CE})$$

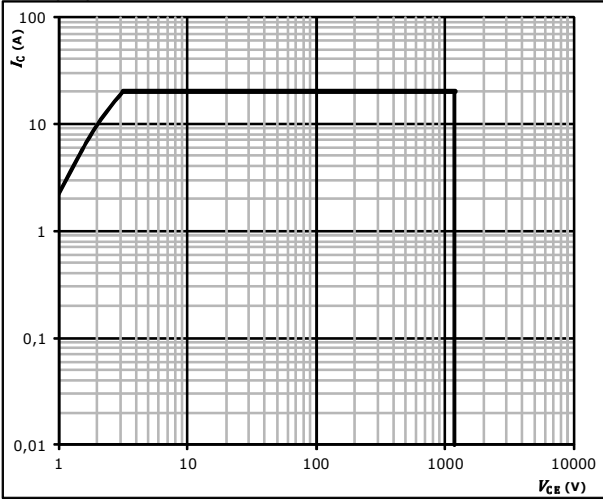

- $D =$ single pulse
- $T_s =$ 80 °C
- $V_{GE} =$ ±15 V
- $T_j =$ T_{jmax}



Brake Diode Characteristics

figure 1. FWD

Typical forward characteristics

$$I_F = f(V_F)$$

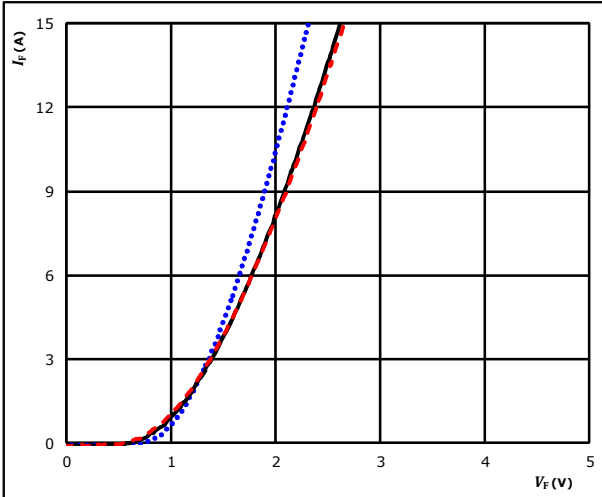

$t_p = 250 \mu s$ T_j : 25 °C
 125 °C ———
 150 °C - - - -

figure 2. FWD

Transient thermal impedance as a function of pulse width

$$Z_{th(j-s)} = f(t_p)$$

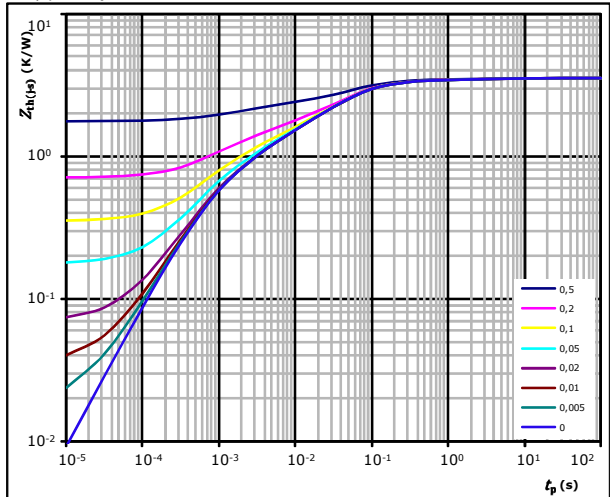

$D = t_p / T$
 $R_{th(j-s)} = 3,50 \text{ K/W}$
 FWD thermal model values

$R \text{ (K/W)}$	$\tau \text{ (s)}$
8,03E-02	7,23E+00
2,34E-01	4,70E-01
1,33E+00	6,36E-02
7,92E-01	2,24E-02
5,71E-01	3,34E-03
4,85E-01	7,05E-04

Thermistor Characteristics

figure 1. Thermistor

Typical NTC characteristic
 as a function of temperature

$$R = f(T)$$

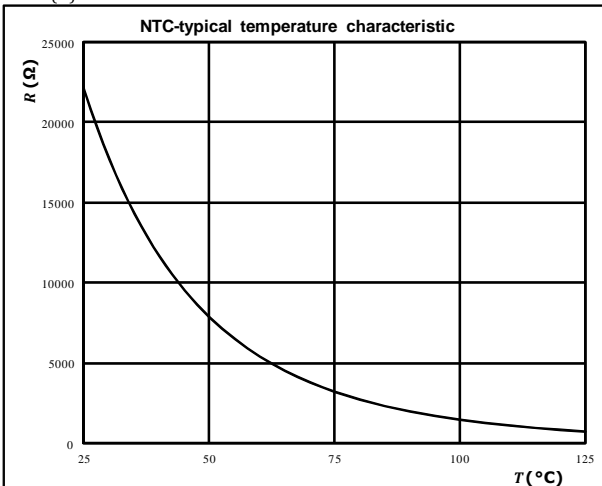



Inverter Switching Characteristics

figure 1. IGBT

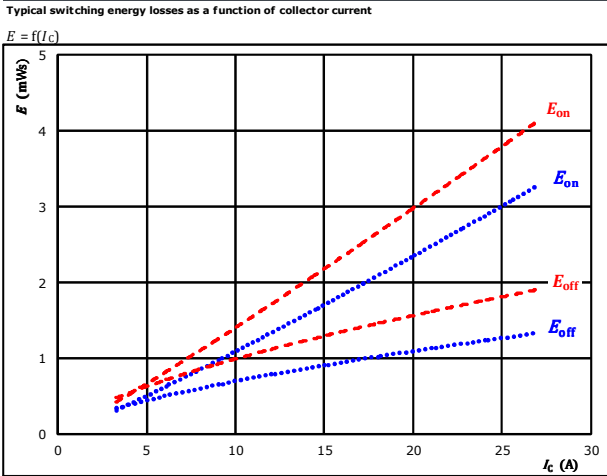

With an inductive load at
 $V_{CE} = 600$ V
 $V_{GE} = \pm 15$ V
 $R_{g(on)} = 32$ Ω
 $R_{g(off)} = 32$ Ω
 $T_j: 25$ $^{\circ}C$ (Blue Dotted)
 150 $^{\circ}C$ (Red Dashed)

figure 2. IGBT

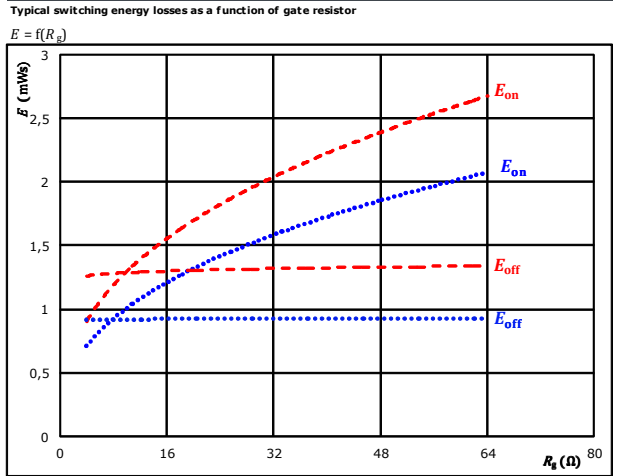

With an inductive load at
 $V_{CE} = 600$ V
 $V_{GE} = \pm 15$ V
 $I_C = 15$ A
 $T_j: 25$ $^{\circ}C$ (Blue Dotted)
 150 $^{\circ}C$ (Red Dashed)

figure 3. FWD

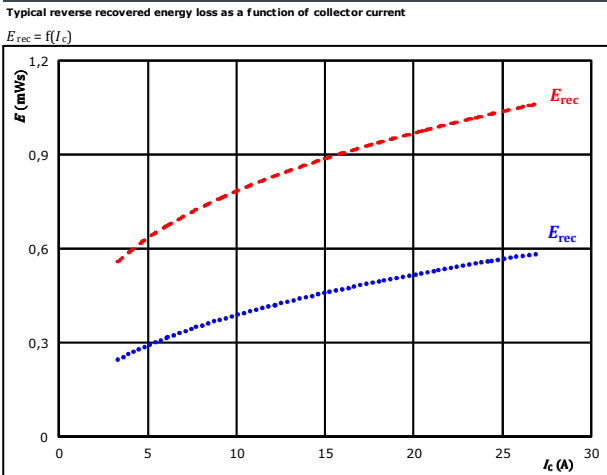

With an inductive load at
 $V_{CE} = 600$ V
 $V_{GE} = \pm 15$ V
 $R_{g(on)} = 32$ Ω
 $T_j: 25$ $^{\circ}C$ (Blue Dotted)
 150 $^{\circ}C$ (Red Dashed)

figure 4. FWD

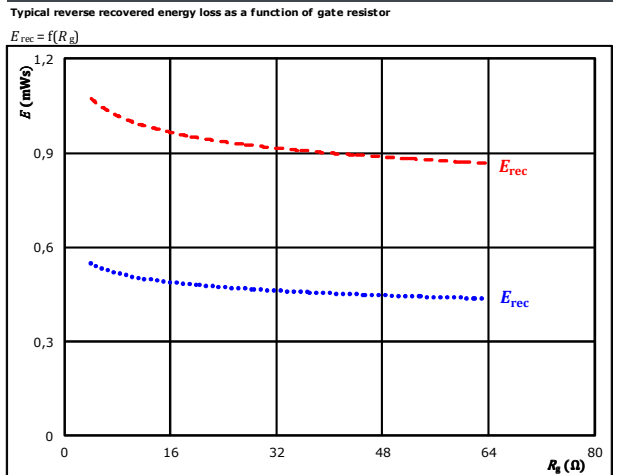

With an inductive load at
 $V_{CE} = 600$ V
 $V_{GE} = \pm 15$ V
 $I_C = 15$ A
 $T_j: 25$ $^{\circ}C$ (Blue Dotted)
 150 $^{\circ}C$ (Red Dashed)



Inverter Switching Characteristics

figure 5. IGBT

Typical switching times as a function of collector current

$$t = f(I_C)$$

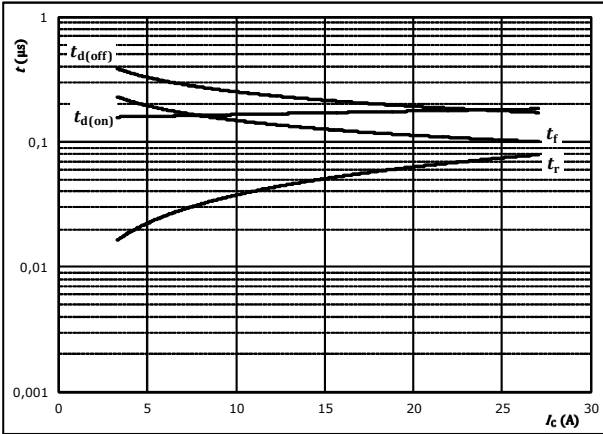

With an inductive load at

$T_j =$	150	°C
$V_{CE} =$	600	V
$V_{GE} =$	±15	V
$R_{gon} =$	32	Ω
$R_{goff} =$	32	Ω

figure 6. IGBT

Typical switching times as a function of gate resistor

$$t = f(R_g)$$

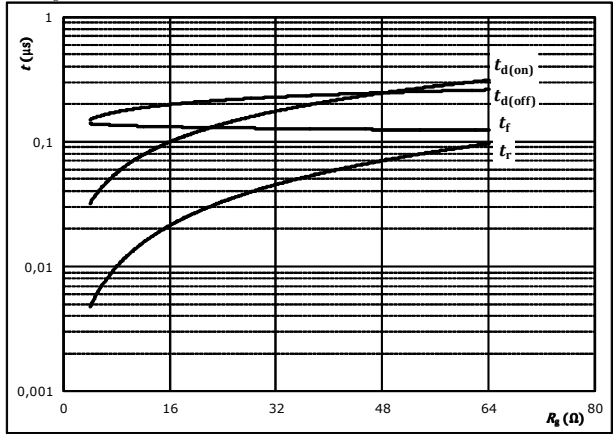

With an inductive load at

$T_j =$	150	°C
$V_{CE} =$	600	V
$V_{GE} =$	±15	V
$I_C =$	15	A

figure 7. FWD

Typical reverse recovery time as a function of collector current

$$t_{rr} = f(I_C)$$

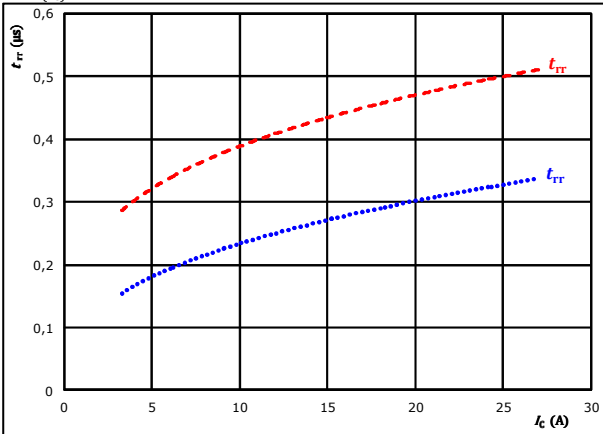

At	$V_{CE} =$	600	V	$T_j =$	25 °C
	$V_{GE} =$	±15	V		150 °C	-----
	$R_{gon} =$	32	Ω			

figure 8. FWD

Typical reverse recovery time as a function of IGBT turn on gate resistor

$$t_{rr} = f(R_{gon})$$

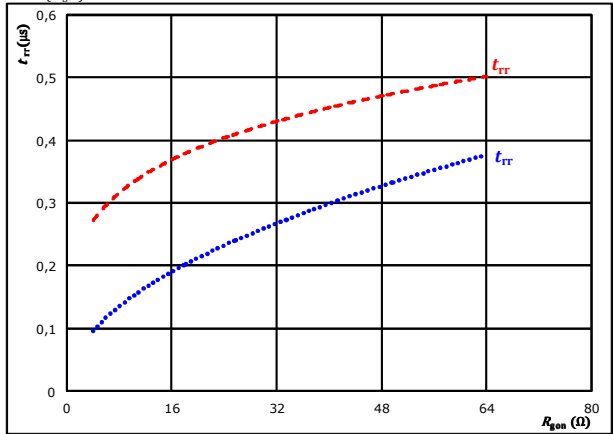

At	$V_{CE} =$	600	V	$T_j =$	25 °C
	$V_{GE} =$	±15	V		150 °C	-----
	$I_C =$	15	A			



Inverter Switching Characteristics

figure 9. FWD
 Typical recovered charge as a function of collector current

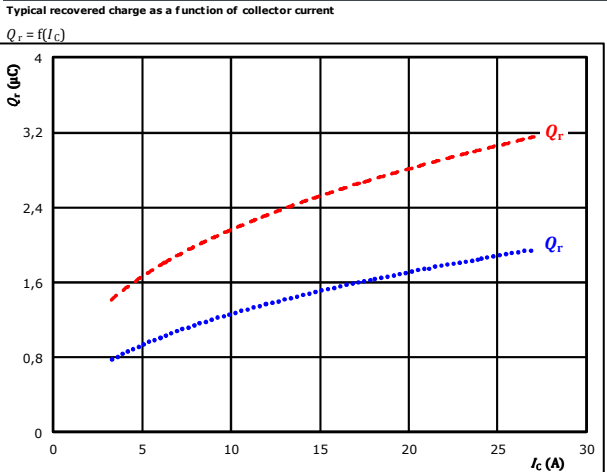

At $V_{CE} = 600$ V
 $V_{GE} = \pm 15$ V
 $R_{gdn} = 32$ Ω
 $T_j: 25$ °C (blue dotted line)
 150 °C (red dashed line)

figure 10. FWD
 Typical recovered charge as a function of IGBT turn on gate resistor

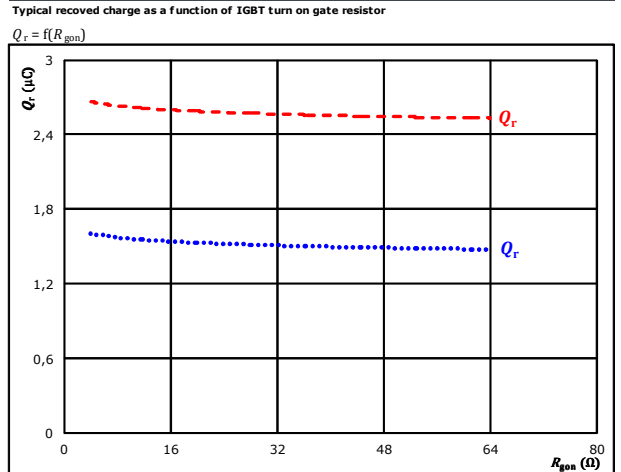

At $V_{CE} = 600$ V
 $V_{GE} = \pm 15$ V
 $I_c = 15$ A
 $T_j: 25$ °C (blue dotted line)
 150 °C (red dashed line)

figure 11. FWD
 Typical peak reverse recovery current current as a function of collector current

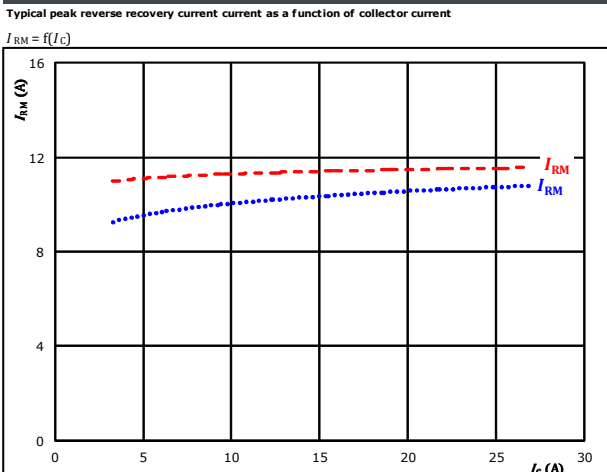

At $V_{CE} = 600$ V
 $V_{GE} = \pm 15$ V
 $R_{gdn} = 32$ Ω
 $T_j: 25$ °C (blue dotted line)
 150 °C (red dashed line)

figure 12. FWD
 Typical peak reverse recovery current current as a function of IGBT turn on gate resistor

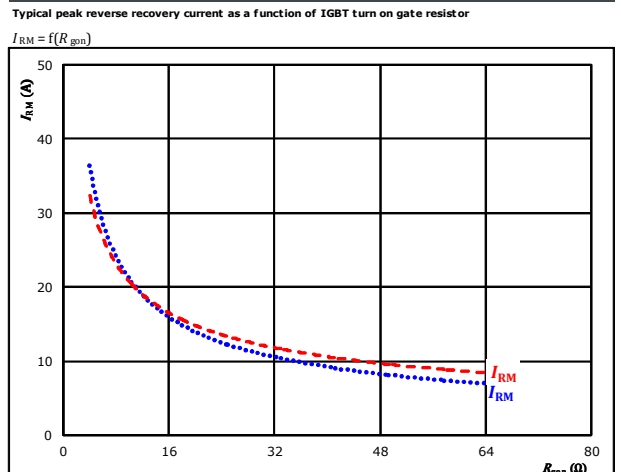

At $V_{CE} = 600$ V
 $V_{GE} = \pm 15$ V
 $I_c = 15$ A
 $T_j: 25$ °C (blue dotted line)
 150 °C (red dashed line)



Vincotech

Inverter Switching Characteristics

figure 13. FWD

Typical rate of fall of forward and reverse recovery current as a function of collector current

$$di_f/dt, di_{rr}/dt = f(I_c)$$

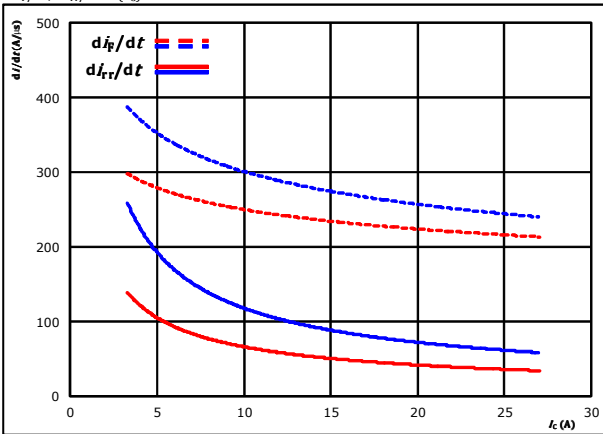

At $V_{CE} = 600$ V $T_j = 25$ °C (blue dotted line)
 $V_{GE} = \pm 15$ V $T_j = 150$ °C (red dashed line)
 $R_{g(on)} = 32$ Ω

figure 14. FWD

Typical rate of fall of forward and reverse recovery current as a function of IGBT turn on gate resistor

$$di_f/dt, di_{rr}/dt = f(R_{g(on)})$$

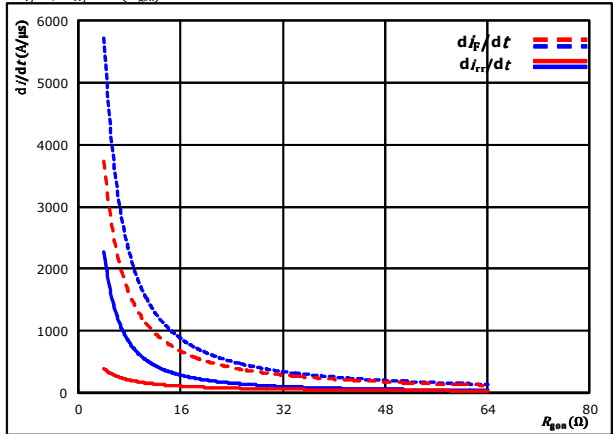

At $V_{CE} = 600$ V $T_j = 25$ °C (blue dotted line)
 $V_{GE} = \pm 15$ V $T_j = 150$ °C (red dashed line)
 $I_c = 15$ A

figure 15. IGBT

Reverse bias safe operating area

$$I_c = f(V_{CE})$$

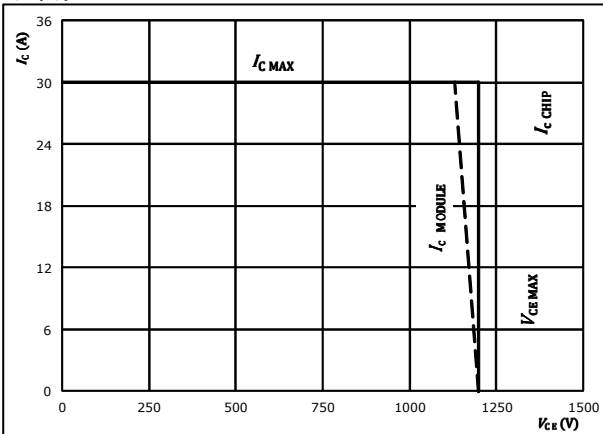

At $T_j = 175$ °C
 $R_{g(on)} = 32$ Ω
 $R_{g(off)} = 32$ Ω



Inverter Switching Definitions

General conditions		
T_j	=	150 °C
R_{gon}	=	32 Ω
R_{goff}	=	32 Ω

figure 1. IGBT

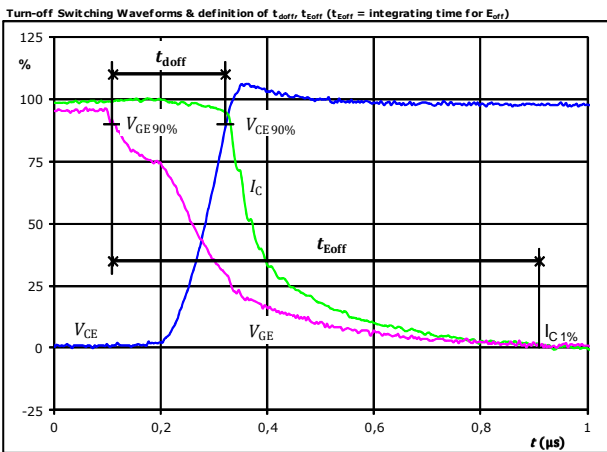

$V_{GE}(0\%) =$	-15	V
$V_{GE}(100\%) =$	15	V
$V_C(100\%) =$	600	V
$I_C(100\%) =$	15	A
$t_{doff} =$	0,218	μs
$t_{Eoff} =$	0,800	μs

figure 2. IGBT

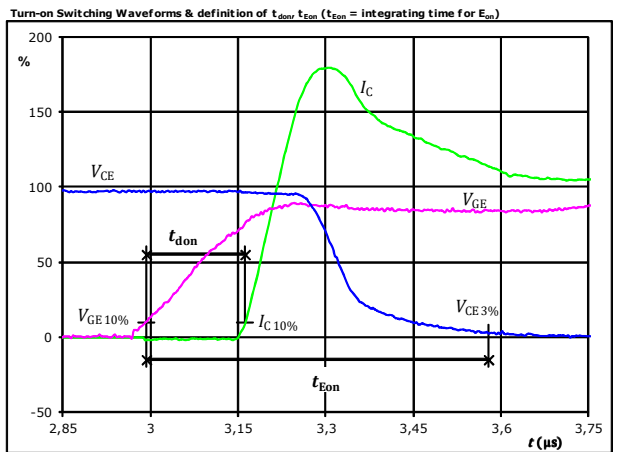

$V_{GE}(0\%) =$	-15	V
$V_{GE}(100\%) =$	15	V
$V_C(100\%) =$	600	V
$I_C(100\%) =$	15	A
$t_{don} =$	0,174	μs
$t_{Eon} =$	0,586	μs

figure 3. IGBT

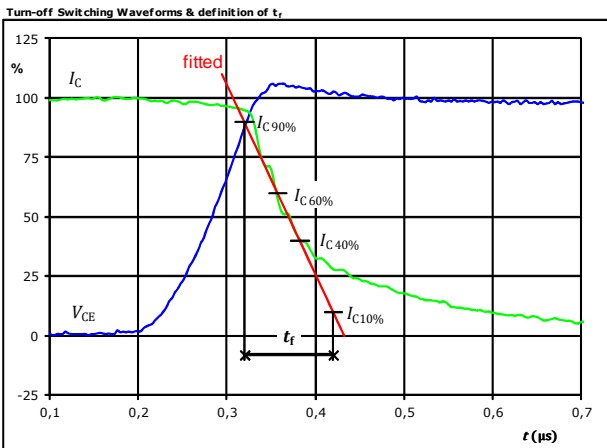

$V_C(100\%) =$	600	V
$I_C(100\%) =$	15	A
$t_f =$	0,127	μs

figure 4. IGBT

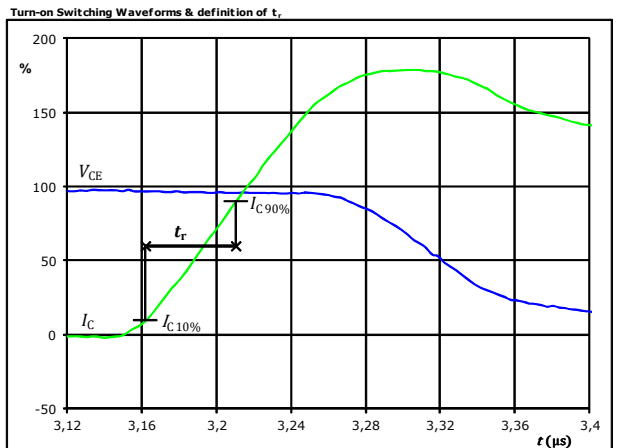

$V_C(100\%) =$	600	V
$I_C(100\%) =$	15	A
$t_r =$	0,048	μs



Vincotech

Inverter Switching Characteristics

figure 5. IGBT

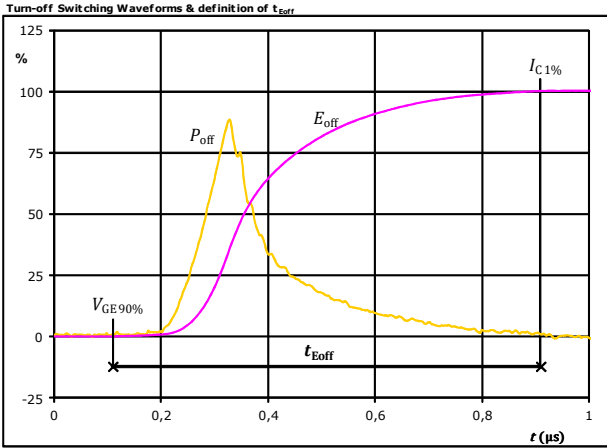

$P_{off}(100\%) =$	9,24	kW
$E_{off}(100\%) =$	1,32	mJ
$t_{Eoff} =$	0,80	μs

figure 6. IGBT

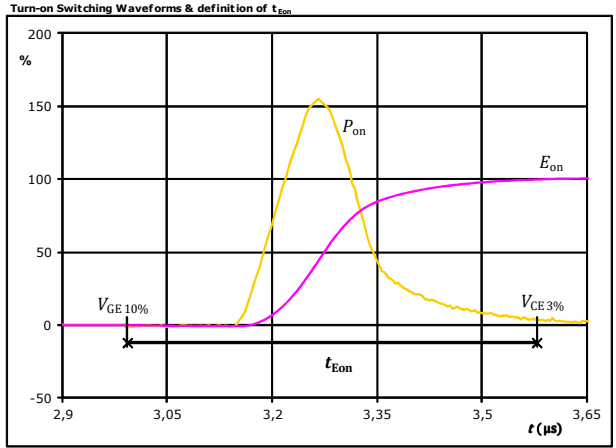

$P_{on}(100\%) =$	9,24	kW
$E_{on}(100\%) =$	2,01	mJ
$t_{Eon} =$	0,59	μs

figure 7. FWD

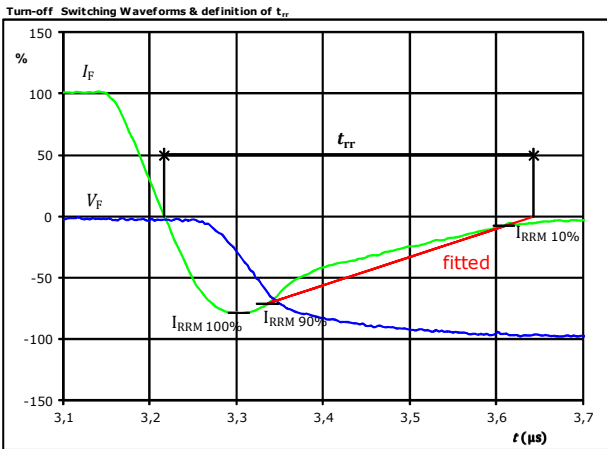

$V_F(100\%) =$	600	V
$I_F(100\%) =$	15	A
$I_{RRM}(100\%) =$	-12	A
$t_{tr} =$	0,423	μs



Vincotech

10-xZ12PMA015M7-P840A28x
10-x012PMA015M7-P840A29x
 datasheet

Inverter Switching Characteristics

figure 8. FWD

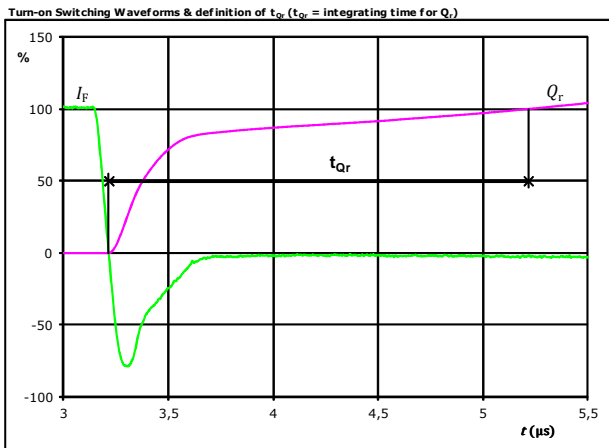

I_F (100%) =	15	A
Q_r (100%) =	2,59	μC
t_{Qr} =	2,00	μs

figure 9. FWD

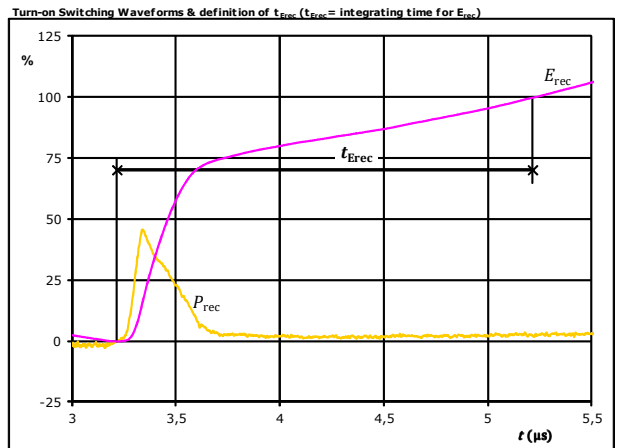

P_{rec} (100%) =	9,24	kW
E_{rec} (100%) =	0,94	mJ
t_{Erec} =	2,00	μs



Brake Switching Characteristics

figure 1. IGBT

Typical switching energy losses as a function of collector current

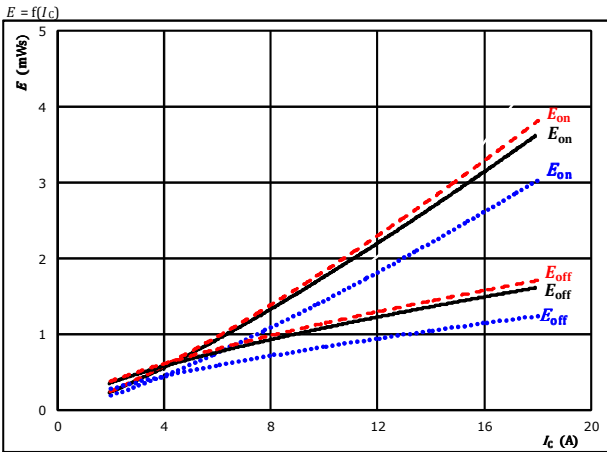

With an inductive load at
 $V_{CE} = 700$ V
 $V_{GE} = 15/0$ V
 $R_{gon} = 64$ Ω
 $R_{goff} = 64$ Ω

T_j : 25 °C (dotted blue), 125 °C (solid black), 150 °C (dashed red)

figure 2. IGBT

Typical switching energy losses as a function of gate resistor

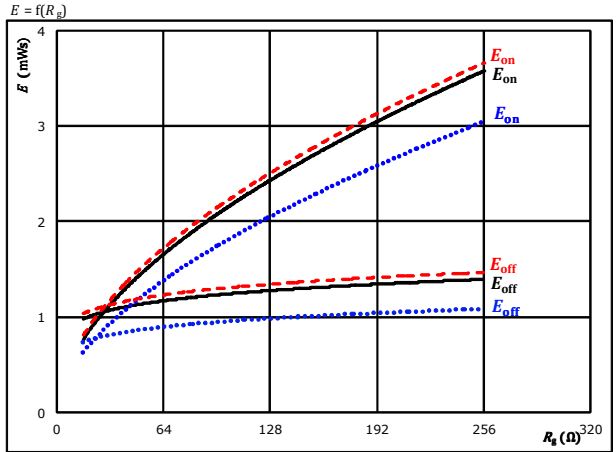

With an inductive load at
 $V_{CE} = 700$ V
 $V_{GE} = 15/0$ V
 $I_C = 10$ A

T_j : 25 °C (dotted blue), 125 °C (solid black), 150 °C (dashed red)

figure 3. FWD

Typical reverse recovered energy loss as a function of collector current

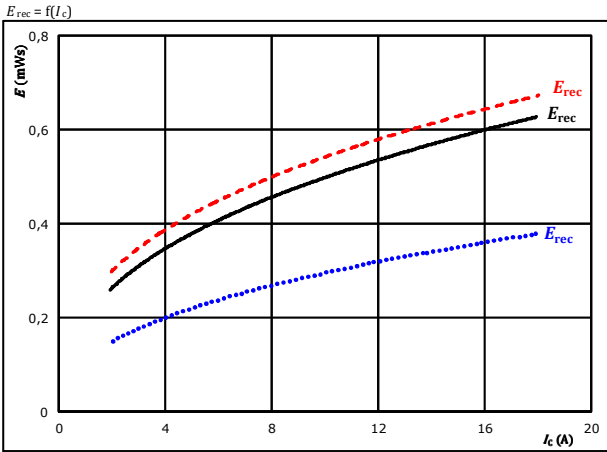

With an inductive load at
 $V_{CE} = 700$ V
 $V_{GE} = 15/0$ V
 $R_{gon} = 64$ Ω

T_j : 25 °C (dotted blue), 125 °C (solid black), 150 °C (dashed red)

figure 4. FWD

Typical reverse recovered energy loss as a function of gate resistor

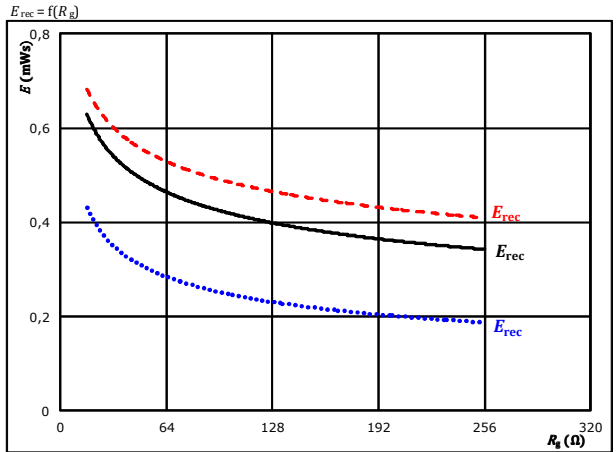

With an inductive load at
 $V_{CE} = 700$ V
 $V_{GE} = 15/0$ V
 $I_C = 10$ A

T_j : 25 °C (dotted blue), 125 °C (solid black), 150 °C (dashed red)



Brake Switching Characteristics

figure 5. IGBT

Typical switching times as a function of collector current

$$t = f(I_C)$$

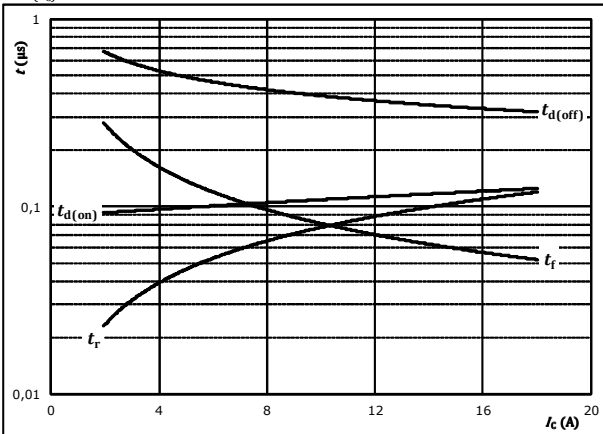

With an inductive load at

$T_j =$	150	°C
$V_{CE} =$	700	V
$V_{GE} =$	15/0	V
$R_{g(on)} =$	64	Ω
$R_{g(off)} =$	64	Ω

figure 6. IGBT

Typical switching times as a function of gate resistor

$$t = f(R_g)$$

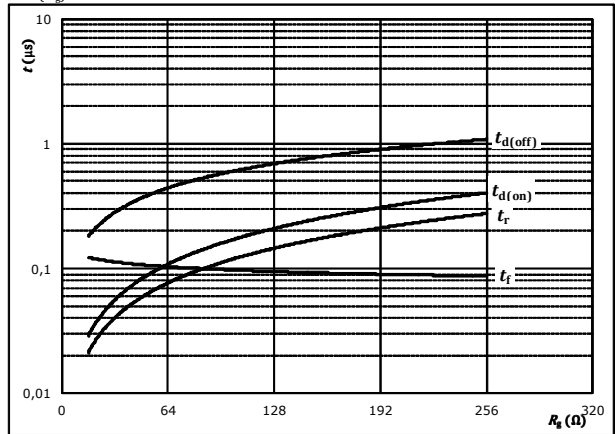

With an inductive load at

$T_j =$	150	°C
$V_{CE} =$	700	V
$V_{GE} =$	15/0	V
$I_C =$	10	A

figure 7. FWD

Typical reverse recovery time as a function of collector current

$$t_{rr} = f(I_C)$$

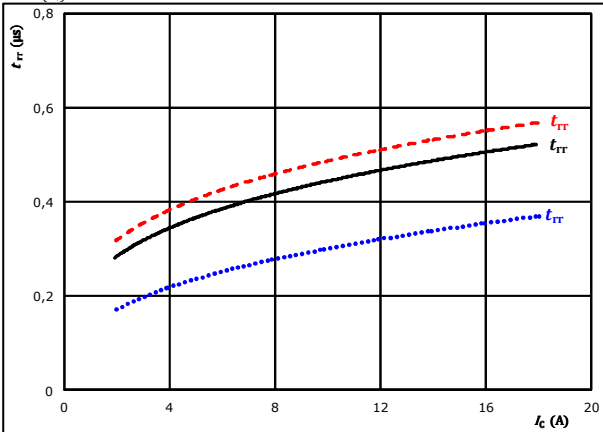

At	$V_{CE} =$	700	V	$T_j:$	25 °C
	$V_{GE} =$	15/0	V		125 °C	————
	$R_{g(on)} =$	64	Ω		150 °C	-----

figure 8. FWD

Typical reverse recovery time as a function of IGBT turn on gate resistor

$$t_{rr} = f(R_{g(on)})$$

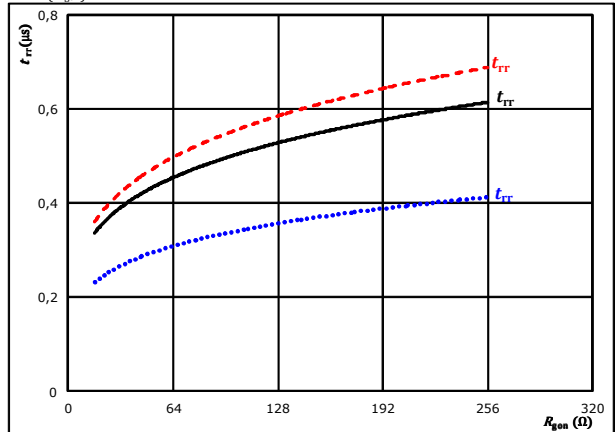

At	$V_{CE} =$	700	V	$T_j:$	25 °C
	$V_{GE} =$	15/0	V		125 °C	————
	$I_C =$	10	A		150 °C	-----



Brake Switching Characteristics

figure 9. FWD
 Typical recovered charge as a function of collector current

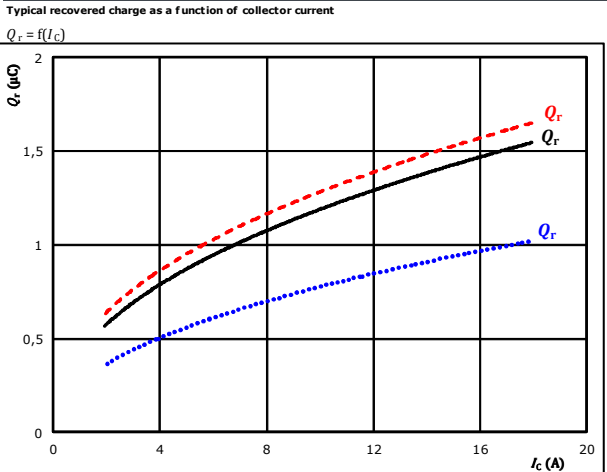

At $V_{CE} = 700$ V $T_j = 25$ °C
 $V_{GE} = 15/0$ V $T_j = 125$ °C ———
 $R_{gdn} = 64$ Ω $T_j = 150$ °C - - - -

figure 10. FWD
 Typical recovered charge as a function of IGBT turn on gate resistor

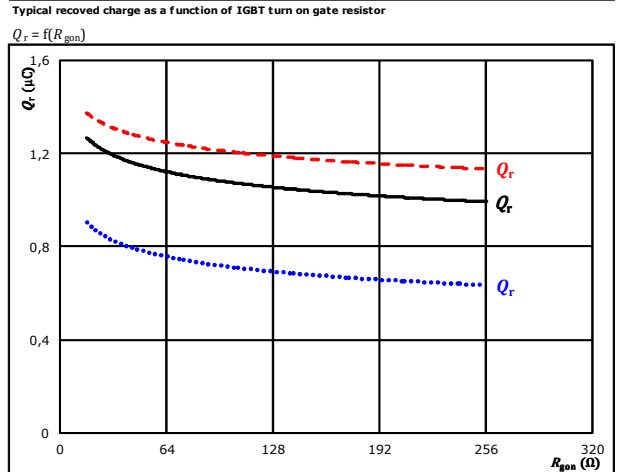

At $V_{CE} = 700$ V $T_j = 25$ °C
 $V_{GE} = 15/0$ V $T_j = 125$ °C ———
 $I_c = 10$ A $T_j = 150$ °C - - - -

figure 11. FWD
 Typical peak reverse recovery current as a function of collector current

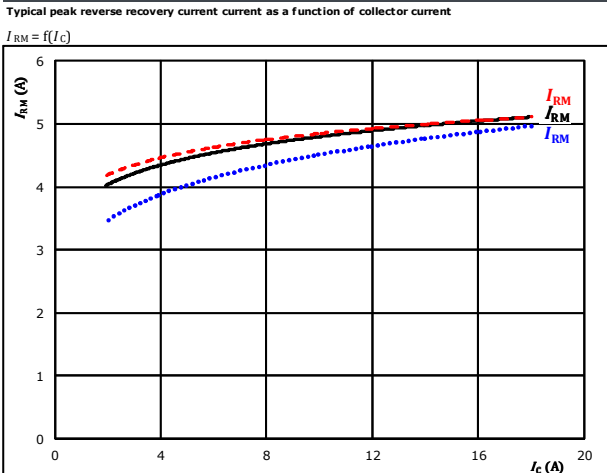

At $V_{CE} = 700$ V $T_j = 25$ °C
 $V_{GE} = 15/0$ V $T_j = 125$ °C ———
 $R_{gdn} = 64$ Ω $T_j = 150$ °C - - - -

figure 12. FWD
 Typical peak reverse recovery current as a function of IGBT turn on gate resistor

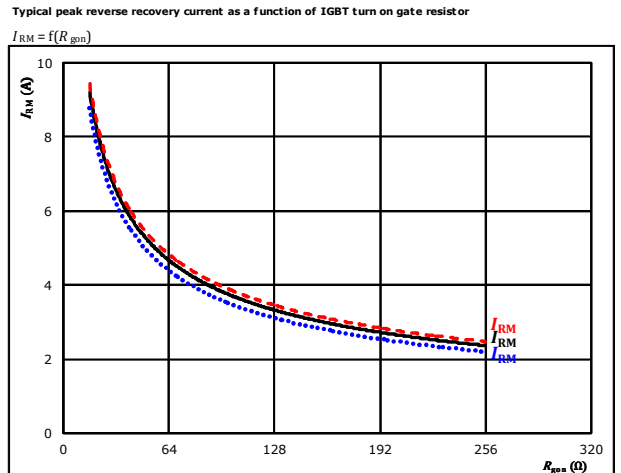

At $V_{CE} = 700$ V $T_j = 25$ °C
 $V_{GE} = 15/0$ V $T_j = 125$ °C ———
 $I_c = 10$ A $T_j = 150$ °C - - - -



Vincotech

Brake Switching Characteristics

figure 13. FWD

Typical rate of fall of forward and reverse recovery current as a function of collector current
 $di_f/dt, di_{rr}/dt = f(I_c)$

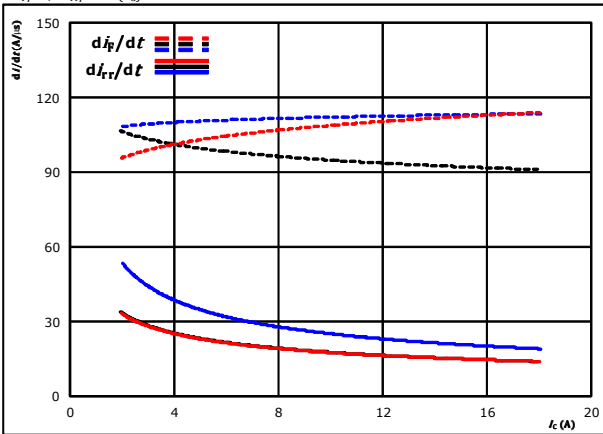

At $V_{CE} = 700$ V $T_j = 25$ °C
 $V_{GE} = 15/0$ V $T_j = 125$ °C ———
 $R_{g0n} = 64$ Ω $T_j = 150$ °C - - - - -

figure 14. FWD

Typical rate of fall of forward and reverse recovery current as a function of IGBT turn on gate resistor
 $di_f/dt, di_{rr}/dt = f(R_{g0n})$

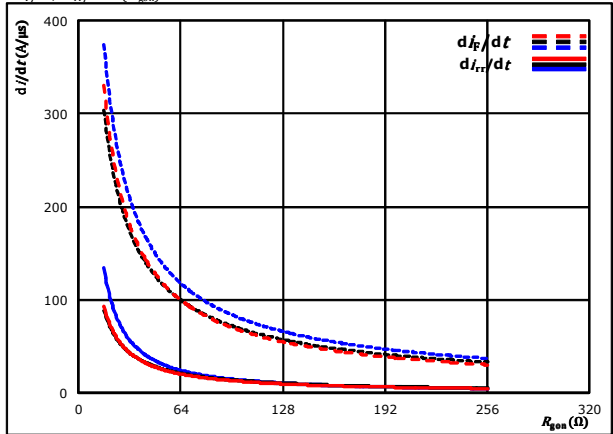

At $V_{CE} = 700$ V $T_j = 25$ °C
 $V_{GE} = 15/0$ V $T_j = 125$ °C ———
 $I_c = 10$ A $T_j = 150$ °C - - - - -

figure 15. IGBT

Reverse bias safe operating area
 $I_c = f(V_{CE})$

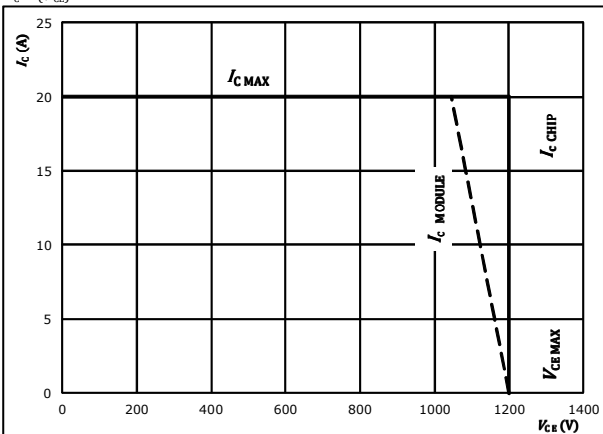

At $T_j = 175$ °C
 $R_{g0n} = 64$ Ω
 $R_{g0ff} = 64$ Ω



Vincotech

10-xZ12PMA015M7-P840A28x
10-xO12PMA015M7-P840A29x
 datasheet

Brake Switching Definitions

General conditions

T_j	=	125 °C
R_{gon}	=	64 Ω
R_{goff}	=	64 Ω

figure 1. IGBT

Turn-off Switching Waveforms & definition of t_{doff} , t_{Eoff} (t_{Eoff} = integrating time for E_{off})

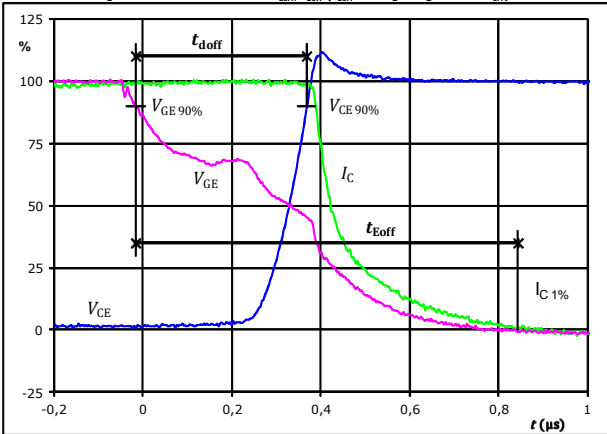

$V_{GE}(0\%) =$	0	V
$V_{GE}(100\%) =$	15	V
$V_C(100\%) =$	700	V
$I_C(100\%) =$	10	A
$t_{doff} =$	0,386	μs
$t_{Eoff} =$	0,861	μs

figure 2. IGBT

Turn-on Switching Waveforms & definition of t_{don} , t_{Eon} (t_{Eon} = integrating time for E_{on})

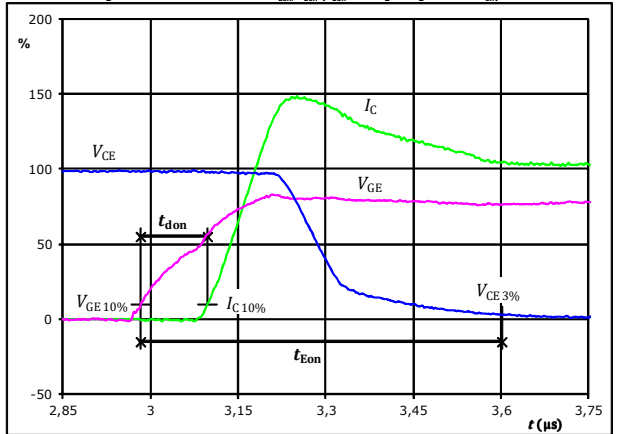

$V_{GE}(0\%) =$	0	V
$V_{GE}(100\%) =$	15	V
$V_C(100\%) =$	700	V
$I_C(100\%) =$	10	A
$t_{don} =$	0,115	μs
$t_{Eon} =$	0,619	μs

figure 3. IGBT

Turn-off Switching Waveforms & definition of t_f

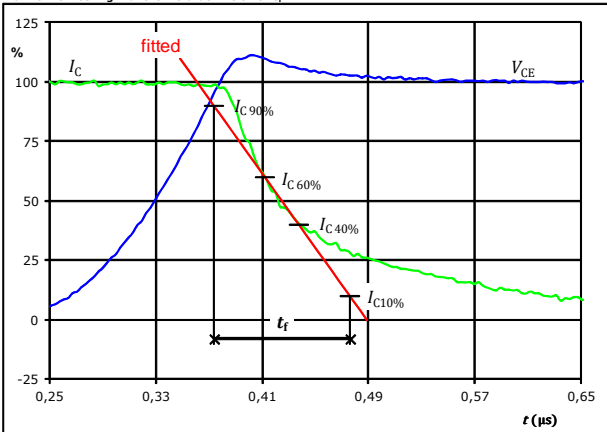

$V_C(100\%) =$	700	V
$I_C(100\%) =$	10	A
$t_f =$	0,113	μs

figure 4. IGBT

Turn-on Switching Waveforms & definition of t_r

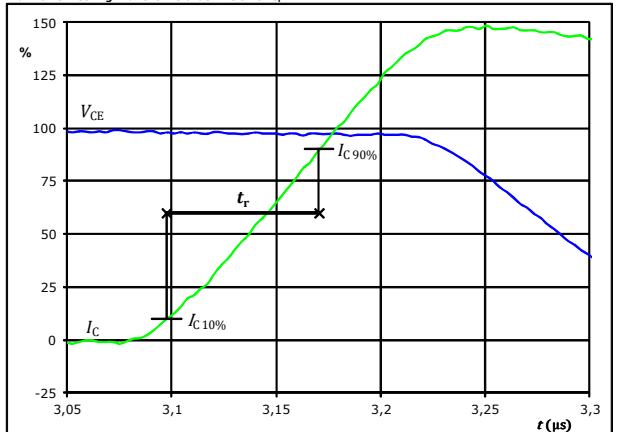

$V_C(100\%) =$	700	V
$I_C(100\%) =$	10	A
$t_r =$	0,073	μs



Vincotech

10-xZ12PMA015M7-P840A28x
10-xO12PMA015M7-P840A29x
 datasheet

Brake Switching Characteristics

figure 5. IGBT

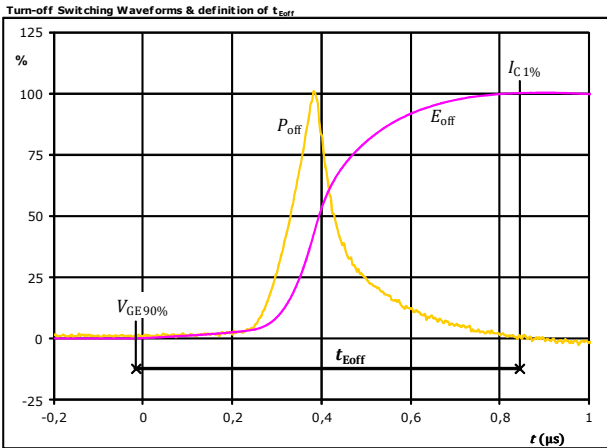

$P_{off}(100\%) = 7,08$ kW
 $E_{off}(100\%) = 1,09$ mJ
 $t_{Eoff} = 0,86$ µs

figure 6. IGBT

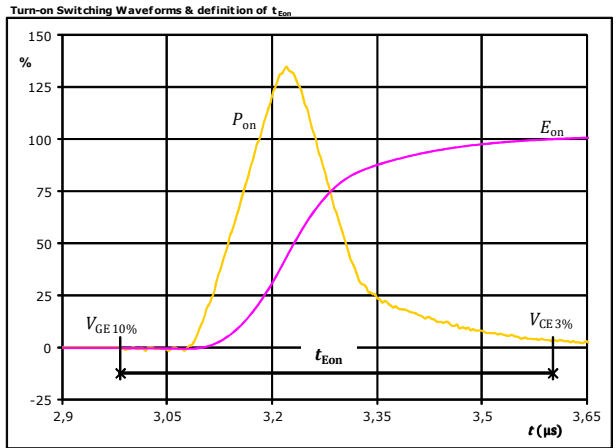

$P_{on}(100\%) = 7,08$ kW
 $E_{on}(100\%) = 1,54$ mJ
 $t_{Eon} = 0,62$ µs

figure 7. FWD

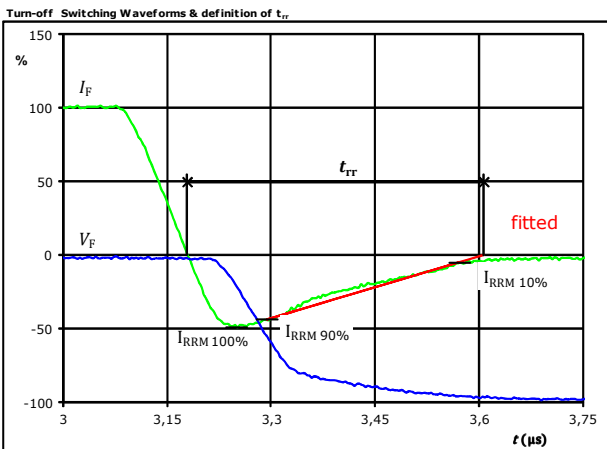

$V_F(100\%) = 700$ V
 $I_F(100\%) = 10$ A
 $I_{RRM}(100\%) = -5$ A
 $t_{rr} = 0,419$ µs



Vincotech

10-xZ12PMA015M7-P840A28x
10-x012PMA015M7-P840A29x
 datasheet

Brake Switching Characteristics

figure 8. FWD

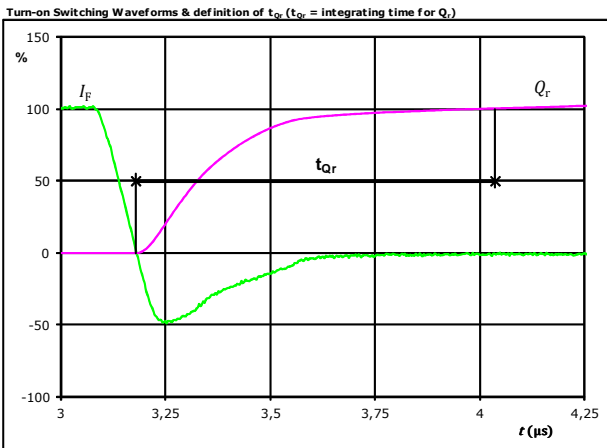

I_F (100%) =	10	A
Q_r (100%) =	1,14	μC
t_{Qr} =	0,86	μs

figure 9. FWD

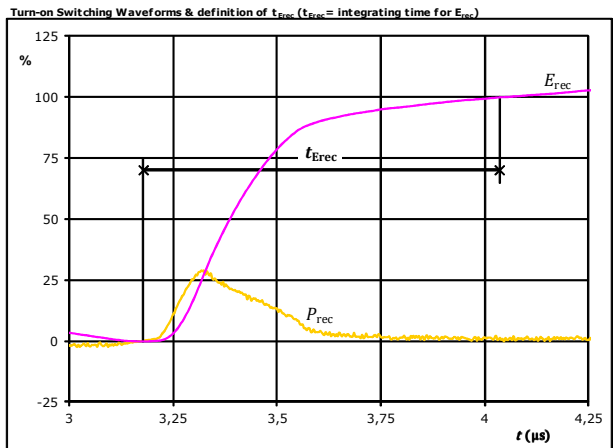

P_{rec} (100%) =	7,08	kW
E_{rec} (100%) =	0,48	mJ
t_{Erec} =	0,86	μs



Ordering Code & Marking								
Version			Ordering Code					
without thermal paste 12 mm housing with solder pins			10-FZ12PMA015M7-P840A28					
with thermal paste 12 mm housing with solder pins			10-FZ12PMA015M7-P840A28-/3/					
without thermal paste 17 mm housing with solder pins			10-F012PMA015M7-P840A29					
with thermal paste 17 mm housing with solder pins			10-F012PMA015M7-P840A29-/3/					
without thermal paste 12 mm housing with Press-fit pins			10-PZ12PMA015M7-P840A28Y					
with thermal paste 12 mm housing with Press-fit pins			10-PZ12PMA015M7-P840A28Y-/3/					
without thermal paste 17 mm housing with Press-fit pins			10-P012PMA015M7-P840A29Y					
with thermal paste 17 mm housing with Press-fit pins			10-P012PMA015M7-P840A29Y-/3/					
NN-NNNNNNNNNNNN TTTTWW WWYY UL VIN LLLLL SSSS			Text	Name	Date code	UL & VIN	Lot	Serial
			Datamatrix	NN-NNNNNNNNNNNN-TTTTWW	WWYY	UL VIN	LLLLL	SSSS
				Type&Ver	Lot number	Serial	Date code	
			TTTTWW	LLLLL	SSSS	WWYY		

Outline

Pin table			
Pin	X	Y	Function
1	25,5	2,7	Therm1
2	25,5	0	Therm2
3	22,8	0	DC-Rect
4	20,1	0	G27
5	16,2	0	DC-Br
6	13,5	0	G15
7	10,8	0	DC-3
8	8,1	0	G13
9	5,4	0	DC-2
10	2,7	0	G11
11	0	0	DC-1
12	0	19,8	G12
13	0	22,5	Ph1
14	7,5	19,8	G14
15	7,5	22,5	Ph2
16	15	19,8	G16
17	15	22,5	Ph3
18	22,8	22,5	DC+Inv
19	25,5	22,5	DC+Rect
20	33,5	22,5	Br
21	33,5	15	ACIn1
22	33,5	7,5	ACIn2
23	33,5	0	ACIn3

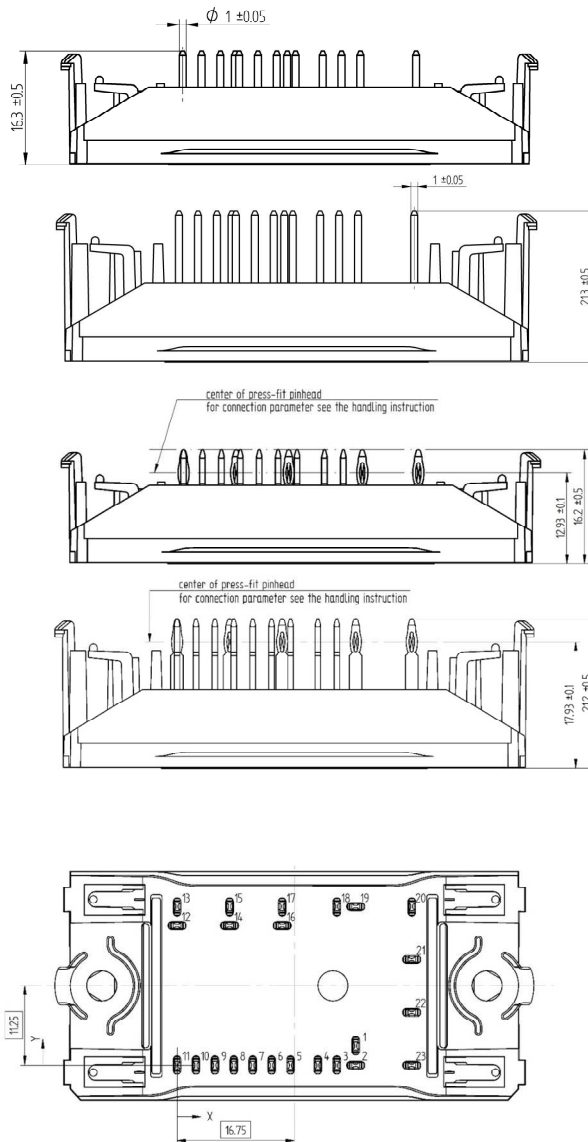

Tolerance of pinpositions: $\pm 0,5$ mm at the end of pins
 Dimension of coordinate axis is only offset without tolerance



Vincotech

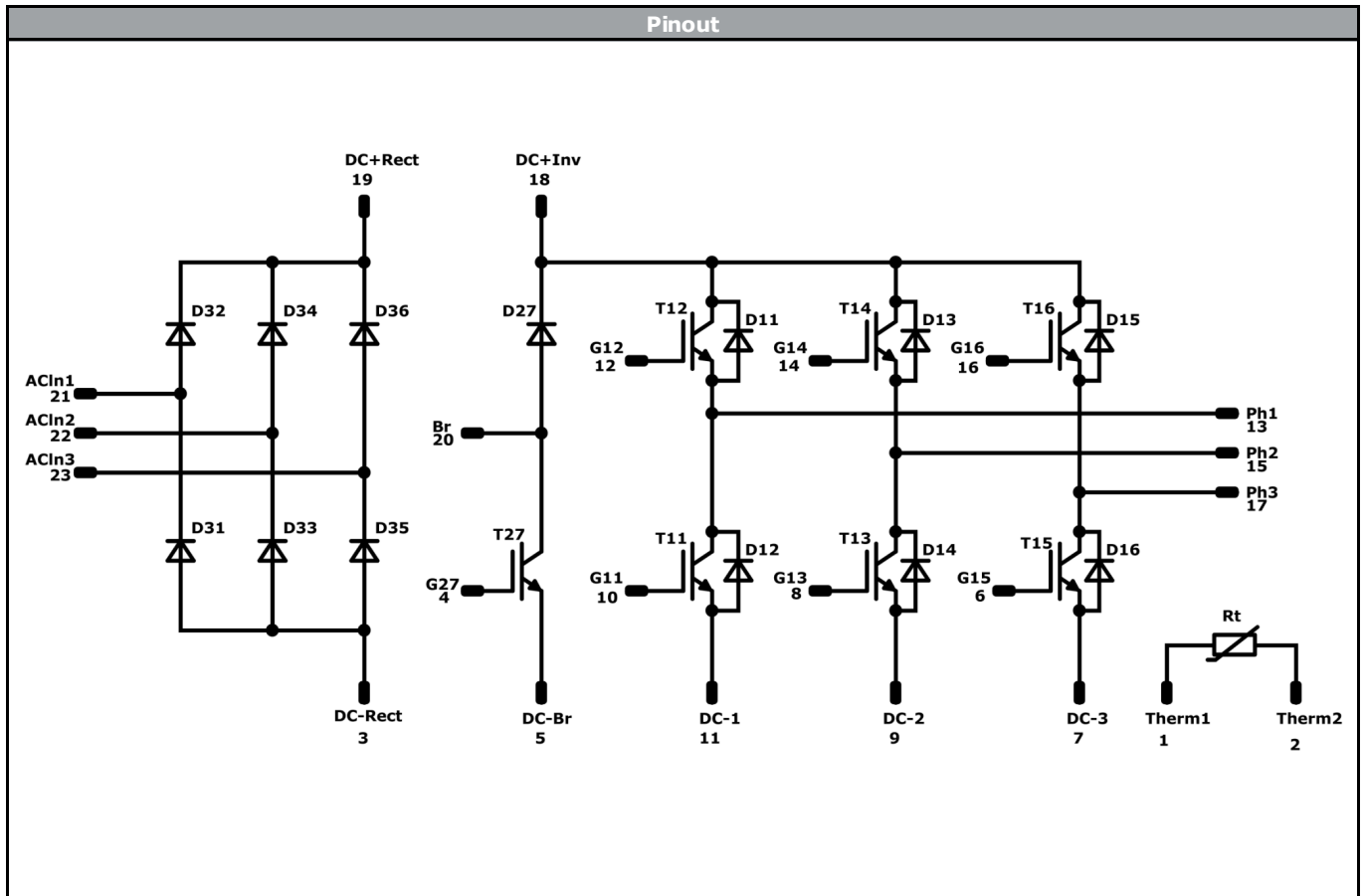

Identification					
ID	Component	Voltage	Current	Function	Comment
D31-D36	Rectifier	1600 V	25 A	Rectifier Diode	
T11-T16	IGBT	1200 V	15 A	Inverter Switch	
D11-D16	FWD	1200 V	15 A	Inverter Diode	
T27	IGBT	1200 V	10 A	Brake Switch	
D27	FWD	1200 V	5 A	Brake Diode	
Rt	NTC			Thermistor	



Vincotech

10-xZ12PMA015M7-P840A28x
10-x012PMA015M7-P840A29x
datasheet

Packaging instruction			
Standard packaging quantity (SPQ) 135	>SPQ	Standard	<SPQ Sample

Handling instruction
Handling instructions for <i>flow 0</i> packages see vincotech.com website.

Package data
Package data for <i>flow 0</i> packages see vincotech.com website.

UL recognition and file number
This device is certified according to UL 1557 standard, UL file number E192116. For more information see vincotech.com website. 

Document No.:	Date:	Modification:	Pages
10-xx12PMA015M7-P840A2xx-D3-14	11 Jan. 2019	Added thermal paste options to ordering code section	29

DISCLAIMER

The information, specifications, procedures, methods and recommendations herein (together "information") are presented by Vincotech to reader in good faith, are believed to be accurate and reliable, but may well be incomplete and/or not applicable to all conditions or situations that may exist or occur. Vincotech reserves the right to make any changes without further notice to any products to improve reliability, function or design. No representation, guarantee or warranty is made to reader as to the accuracy, reliability or completeness of said information or that the application or use of any of the same will avoid hazards, accidents, losses, damages or injury of any kind to persons or property or that the same will not infringe third parties rights or give desired results. It is reader's sole responsibility to test and determine the suitability of the information and the product for reader's intended use.

LIFE SUPPORT POLICY

Vincotech products are not authorised for use as critical components in life support devices or systems without the express written approval of Vincotech.

As used herein:

1. Life support devices or systems are devices or systems which, (a) are intended for surgical implant into the body, or (b) support or sustain life, or (c) whose failure to perform when properly used in accordance with instructions for use provided in labelling can be reasonably expected to result in significant injury to the user.
2. A critical component is any component of a life support device or system whose failure to perform can be reasonably expected to cause the failure of the life support device or system, or to affect its safety or effectiveness.

单击下面可查看定价，库存，交付和生命周期等信息

[>>Vincotech\(威科\)](#)