



flowMNPC 0

1200 V / 80 A

Topology features

- Kelvin Emitter for improved switching performance
- Temperature sensor
- Mixed Voltage Neutral Point Clamped Topology (T-Type)

Component features

- 5us short circuit withstand time
- High speed switching
- Minimized tail current

Housing features

- Base isolation: Al₂O₃
- Clip-in, reliable mechanical connection, qualified for wave soldering
- Convex shaped substrate for superior thermal contact
- Thermo-mechanical push-and-pull force relief
- Solder pin

Target applications

- Energy Storage Systems
- Industrial Drives
- Solar Inverters
- UPS

Types

- 10-FZ12NMA080F205-M260F53

flow 0 12 mm housing

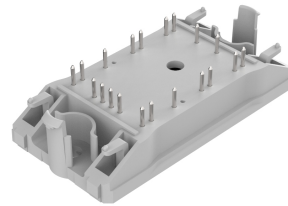

Schematic

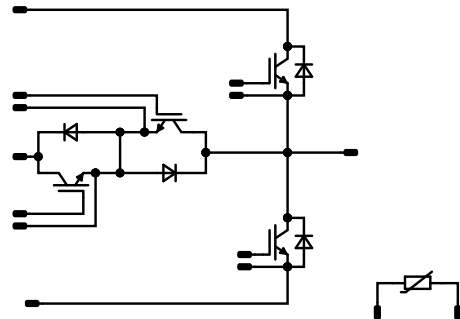



Vincotech

10-FZ12NMA080F205-M260F53
datasheet

Maximum Ratings

$T_j = 25\text{ °C}$, unless otherwise specified

| Parameter | Symbol | Conditions | Value | Unit |
|-----------------------------------|------------|------------------------------------------------------------------------|-------|------|
| Buck Switch | | | | |
| Collector-emitter voltage | V_{CES} | | 1200 | V |
| Collector current (DC current) | I_C | $T_j = T_{jmax}$ $T_s = 80\text{ °C}$ | 76 | A |
| Repetitive peak collector current | I_{CRM} | t_p limited by T_{jmax} | 240 | A |
| Total power dissipation | P_{tot} | $T_j = T_{jmax}$ $T_s = 80\text{ °C}$ | 186 | W |
| Gate-emitter voltage | V_{GES} | | ±20 | V |
| Short circuit ratings | t_{SC} | $V_{GE} = 15\text{ V}$, $V_{CC} = 600\text{ V}$ $T_j = 150\text{ °C}$ | 5 | µs |
| Maximum junction temperature | T_{jmax} | | 175 | °C |

Buck Diode

| | | | | |
|---------------------------------|------------|---------------------------------------|-----|----|
| Peak repetitive reverse voltage | V_{RRM} | | 600 | V |
| Forward current (DC current) | I_F | $T_j = T_{jmax}$ $T_s = 80\text{ °C}$ | 51 | A |
| Total power dissipation | P_{tot} | $T_j = T_{jmax}$ $T_s = 80\text{ °C}$ | 69 | W |
| Maximum junction temperature | T_{jmax} | | 175 | °C |

Boost Switch

| | | | | |
|-----------------------------------|------------|---------------------------------------|-----|----|
| Collector-emitter voltage | V_{CES} | | 650 | V |
| Collector current (DC current) | I_C | $T_j = T_{jmax}$ $T_s = 80\text{ °C}$ | 59 | A |
| Repetitive peak collector current | I_{CRM} | t_p limited by T_{jmax} | 225 | A |
| Total power dissipation | P_{tot} | $T_j = T_{jmax}$ $T_s = 80\text{ °C}$ | 86 | W |
| Gate-emitter voltage | V_{GES} | | ±20 | V |
| Maximum junction temperature | T_{jmax} | | 175 | °C |



Vincotech

10-FZ12NMA080F205-M260F53
datasheet

Maximum Ratings

$T_j = 25\text{ °C}$, unless otherwise specified

| Parameter | Symbol | Conditions | Value | Unit |
|----------------------------------------|------------|----------------------------------------------------------------------|-------|------------------|
| Boost Diode | | | | |
| Peak repetitive reverse voltage | V_{RRM} | | 1200 | V |
| Forward current (DC current) | I_F | $T_j = T_{jmax}$ $T_s = 80\text{ °C}$ | 44 | A |
| Surge (non-repetitive) forward current | I_{FSM} | Single Half Sine Wave, $t_p = 10\text{ ms}$ $T_j = 150\text{ °C}$ | 270 | A |
| Surge current capability | I^2t | | 365 | A ² s |
| Total power dissipation | P_{tot} | $T_j = T_{jmax}$ $T_s = 80\text{ °C}$ | 94 | W |
| Maximum junction temperature | T_{jmax} | | 175 | °C |

Module Properties

Thermal Properties

| | | | | |
|-------------------------------------------------|-----------|--|----------------------------|----|
| Storage temperature | T_{stg} | | -40...+125 | °C |
| Operation temperature under switching condition | T_{jop} | | -40...+($T_{jmax} - 25$) | °C |

Isolation Properties

| | | | | |
|----------------------------|------------|-------------------------------------|-------|----|
| Isolation voltage | V_{isol} | DC Test Voltage* $t_p = 2\text{ s}$ | 6000 | V |
| Isolation voltage | V_{isol} | AC Voltage $t_p = 1\text{ min}$ | 2500 | V |
| Creepage distance | | | >12,7 | mm |
| Clearance | | | 9,15 | mm |
| Comparative Tracking Index | CTI | | ≥ 200 | |

*100 % tested in production



Vincotech

10-FZ12NMA080F205-M260F53
datasheet

Characteristic Values

| Parameter | Symbol | Conditions | | | | | Values | | | Unit |
|-----------|--------|--------------|--------------|--------------|-----------|------------|--------|-----|-----|------|
| | | V_{GS} [V] | V_{GE} [V] | V_{DS} [V] | I_D [A] | T_j [°C] | Min | Typ | Max | |

Buck Switch

Static

| | | | | | | | | | | |
|--------------------------------------|---------------|-------------------|------|----|-------|------------------|---|----------------------|--------------------|----|
| Gate-emitter threshold voltage | $V_{GE(th)}$ | $V_{CE} = V_{GE}$ | | | 0,004 | 25 | 5 | 6 | 7 | V |
| Collector-emitter saturation voltage | $V_{CE(sat)}$ | | 15 | | 80 | 25 125 150 | | 2,18 2,39 2,44 | 2,6 ⁽¹⁾ | V |
| Collector-emitter cut-off current | I_{CES} | | 20 | 0 | | 25 | | | 50 | μA |
| Gate-emitter leakage current | I_{GES} | | 20 | 0 | | 25 | | | 500 | nA |
| Internal gate resistance | r_g | | | | | | | None | | Ω |
| Input capacitance | C_{ies} | | | | | | | 6400 | | pF |
| Output capacitance | C_{oes} | $f = 1$ Mhz | 0 | 25 | | 25 | | 440 | | pF |
| Reverse transfer capacitance | C_{res} | | | | | | | 160 | | pF |
| Gate charge | Q_g | $V_{CC} = 960$ V | 0/15 | | 80 | 25 | | 316 | | nC |

Thermal

| | | | | | | | | | | |
|----------------------------------------------------|---------------|------------------------------------|--|--|--|--|--|------|--|-----|
| Thermal resistance junction to sink ⁽²⁾ | $R_{th(j-s)}$ | $\lambda_{paste} = 3,4$ W/mK (PSX) | | | | | | 0,51 | | K/W |
|----------------------------------------------------|---------------|------------------------------------|--|--|--|--|--|------|--|-----|

Dynamic

| | | | | | | | | | | |
|-----------------------------|--------------|----------------------------------------------------------------------|--|--|--|------------------|--|-------------------------|--|-----|
| Turn-on delay time | $t_{d(on)}$ | | | | | 25 125 150 | | 51,72 51,69 51,75 | | ns |
| Rise time | t_r | | | | | 25 125 150 | | 10,05 10,67 10,8 | | ns |
| Turn-off delay time | $t_{d(off)}$ | | | | | 25 125 150 | | 59,79 73,88 78,32 | | ns |
| Fall time | t_f | | | | | 25 125 150 | | 37,81 57,28 63,12 | | ns |
| Turn-on energy (per pulse) | E_{on} | $Q_{tFWD} = 1,01$ μC $Q_{tFWD} = 2,54$ μC $Q_{tFWD} = 3,25$ μC | | | | 25 125 150 | | 0,574 1,05 1,21 | | mWs |
| Turn-off energy (per pulse) | E_{off} | | | | | 25 125 150 | | 1,01 1,76 2,06 | | mWs |



Vincotech

10-FZ12NMA080F205-M260F53
datasheet

Characteristic Values

| Parameter | Symbol | Conditions | | | | | Values | | | Unit |
|-----------|--------|------------------------------|-------------------------------------------|-------------------------------------|------------|-----|--------|-----|--|------|
| | | V_{GE} [V] V_{GS} [V] | V_{CE} [V] V_{DS} [V] V_F [V] | I_C [A] I_D [A] I_F [A] | T_j [°C] | Min | Typ | Max | | |

Buck Diode

Static

| | | | | | | | | | | |
|-------------------------|-------|---------------|--|--|----|------------------|--|----------------------|--------------------|----|
| Forward voltage | V_F | | | | 60 | 25 125 150 | | 2,27 1,68 1,58 | 2,8 ⁽¹⁾ | V |
| Reverse leakage current | I_R | $V_T = 600$ V | | | | 25 | | | 10 | μA |

Thermal

| | | | | | | | | | | |
|----------------------------------------------------|---------------|---------------------------------------|--|--|--|--|--|------|--|-----|
| Thermal resistance junction to sink ⁽²⁾ | $R_{th(j-s)}$ | $\lambda_{paste} = 3,4$ W/mK (PSX) | | | | | | 1,38 | | K/W |
|----------------------------------------------------|---------------|---------------------------------------|--|--|--|--|--|------|--|-----|

Dynamic

| | | | | | | | | | | |
|---------------------------------------|-------------------|-------------------------------------------------------------|-----|-----|----|------------------|--|--------------------------------|--|------|
| Peak recovery current | I_{RM} | | | | | 25 125 150 | | 78,93 98,7 107,7 | | A |
| Reverse recovery time | t_{rr} | | | | | 25 125 150 | | 23,12 51,55 68,95 | | ns |
| Recovered charge | Q_r | $di/dt=6620$ A/μs $di/dt=5238$ A/μs $di/dt=5071$ A/μs | ±15 | 350 | 55 | 25 125 150 | | 1,01 2,54 3,25 | | μC |
| Reverse recovered energy | E_{rec} | | | | | 25 125 150 | | 0,141 0,403 0,536 | | mWs |
| Peak rate of fall of recovery current | $(di_r/dt)_{max}$ | | | | | 25 125 150 | | 11555,08 6307,82 5897,32 | | A/μs |



Vincotech

10-FZ12NMA080F205-M260F53
datasheet

Characteristic Values

| Parameter | Symbol | Conditions | | | | | Values | | | Unit |
|-----------|--------|--------------|--------------|--------------|-----------|-------------------------------------|------------|-----|-----|------|
| | | V_{GS} [V] | V_{GE} [V] | V_{DS} [V] | V_F [V] | I_C [A] I_D [A] I_F [A] | T_j [°C] | Min | Typ | |

Boost Switch

Static

| | | | | | | | | | | | |
|--------------------------------------|---------------|-------------------|----|-----|----|---------|------------------|-----|----------------------|---------------------|----|
| Gate-emitter threshold voltage | $V_{GE(th)}$ | $V_{CE} = V_{GE}$ | | | | 0,00075 | 25 | 3,2 | 4 | 4,8 | V |
| Collector-emitter saturation voltage | $V_{CE(sat)}$ | | 15 | | 75 | | 25 125 150 | | 1,56 1,56 1,59 | 1,75 ⁽¹⁾ | V |
| Collector-emitter cut-off current | I_{CES} | | 0 | 650 | | | 25 | | | 50 | μA |
| Gate-emitter leakage current | I_{GES} | | 20 | 0 | | | 25 | | | 100 | nA |
| Internal gate resistance | r_g | | | | | | | | None | | Ω |
| Input capacitance | C_{ies} | | | | | | | | 4500 | | pF |
| Output capacitance | C_{oes} | $f = 1$ Mhz | 0 | 25 | | | 25 | | 130 | | pF |
| Reverse transfer capacitance | C_{res} | | | | | | | | 17 | | pF |
| Gate charge | Q_g | $V_{CC} = 520$ V | 15 | | 75 | | 25 | | 164 | | nC |

Thermal

| | | | | | | | | | | | |
|----------------------------------------------------|---------------|---------------------------------------|--|--|--|--|--|--|-----|--|-----|
| Thermal resistance junction to sink ⁽²⁾ | $R_{th(j-s)}$ | $\lambda_{paste} = 3,4$ W/mK (PSX) | | | | | | | 1,1 | | K/W |
|----------------------------------------------------|---------------|---------------------------------------|--|--|--|--|--|--|-----|--|-----|

Dynamic

| | | | | | | | | | | | |
|-----------------------------|--------------|---------------------------------------------------------------------|--|--|--|--|------------------|--|----------------------------|--|-----|
| Turn-on delay time | $t_{d(on)}$ | | | | | | 25 125 150 | | 147,86 148,56 148,32 | | ns |
| Rise time | t_r | | | | | | 25 125 150 | | 14,94 17,75 18,76 | | ns |
| Turn-off delay time | $t_{d(off)}$ | | | | | | 25 125 150 | | 131,26 148,34 153,5 | | ns |
| Fall time | t_f | | | | | | 25 125 150 | | 16,43 40,62 44,67 | | ns |
| Turn-on energy (per pulse) | E_{on} | $Q_{tfwd} = 1,77$ μC $Q_{tfwd} = 3,8$ μC $Q_{tfwd} = 4,55$ μC | | | | | 25 125 150 | | 1,24 1,47 1,55 | | mWs |
| Turn-off energy (per pulse) | E_{off} | | | | | | 25 125 150 | | 0,783 1,2 1,33 | | mWs |



Vincotech

10-FZ12NMA080F205-M260F53
datasheet

Characteristic Values

| Parameter | Symbol | Conditions | | | | | Values | | | Unit |
|----------------------------------------------------|-------------------|-------------------------------------------------------------|-------------------------------------------|-------------------------------------|------------|------------------|--------|-------------------------------|-------------------------------------------|------|
| | | V_{GE} [V] V_{GS} [V] | V_{CE} [V] V_{DS} [V] V_F [V] | I_C [A] I_D [A] I_F [A] | T_j [°C] | Min | Typ | Max | | |
| Boost Diode | | | | | | | | | | |
| Static | | | | | | | | | | |
| Forward voltage | V_F | | | | 50 | 25 125 150 | | 2,22 2,31 2,21 | 2,54 ⁽¹⁾ 2,5 ⁽¹⁾ | V |
| Reverse leakage current | I_R | $V_r = 1200$ V | | | | 25 150 | | 4400 | 60 8800 | μA |
| Thermal | | | | | | | | | | |
| Thermal resistance junction to sink ⁽²⁾ | $R_{th(j-s)}$ | $\lambda_{paste} = 3,4$ W/mK (PSX) | | | | | | 1,02 | | K/W |
| Dynamic | | | | | | | | | | |
| Peak recovery current | I_{RM} | | | | | 25 125 150 | | 82,66 100,13 108,75 | | A |
| Reverse recovery time | t_{rr} | | | | | 25 125 150 | | 37,78 123,66 130,08 | | ns |
| Recovered charge | Q_r | $di/dt=4895$ A/μs $di/dt=4510$ A/μs $di/dt=4310$ A/μs | ±15 | 350 | 70 | 25 125 150 | | 1,77 3,8 4,55 | | μC |
| Reverse recovered energy | E_{rec} | | | | | 25 125 150 | | 0,228 0,708 0,878 | | mWs |
| Peak rate of fall of recovery current | $(di_r/dt)_{max}$ | | | | | 25 125 150 | | 6587,02 5434,74 5156,51 | | A/μs |



Vincotech

Characteristic Values

| Parameter | Symbol | Conditions | | | | | Values | | | Unit |
|-----------|--------|--------------|--------------|--------------|--------------|------------|--------|-----|-----|------|
| | | V_{GS} [V] | V_{GE} [V] | V_{DS} [V] | V_{CE} [V] | T_j [°C] | Min | Typ | Max | |

Thermistor

Static

| | | | | | | | | | | |
|--------------------------------|----------------|-------------------------|--|--|--|-----|----|------|---|------|
| Rated resistance | R | | | | | 25 | | 22 | | kΩ |
| Deviation of R_{100} | $A_{R/R}$ | $R_{100} = 1484 \Omega$ | | | | 100 | -5 | | 5 | % |
| Power dissipation | P | | | | | 25 | | 130 | | mW |
| Power dissipation constant | d | | | | | 25 | | 1,5 | | mW/K |
| B-value | $B_{(25/50)}$ | Tol. $\pm 1 \%$ | | | | | | 3962 | | K |
| B-value | $B_{(25/100)}$ | Tol. $\pm 1 \%$ | | | | | | 4000 | | K |
| Vincotech Thermistor Reference | | | | | | | | | I | |

⁽¹⁾ Value at chip level

⁽²⁾ Only valid with pre-applied Vincotech thermal interface material.



Buck Switch Characteristics

figure 1. IGBT

Typical output characteristics

$$I_C = f(V_{CE})$$

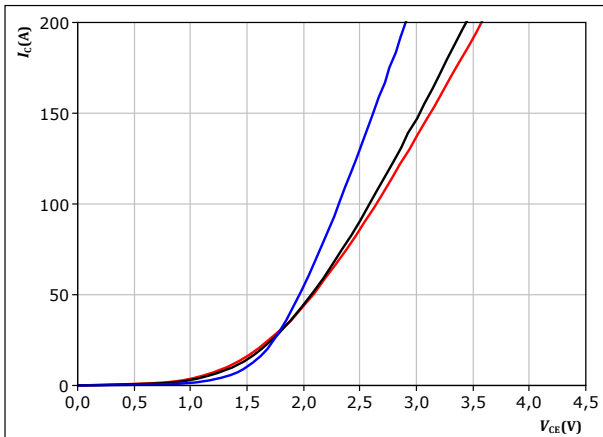

$t_p = 250 \mu s$
 $V_{GE} = 15 V$
 $T_j:$ — 25 °C
— 125 °C
— 150 °C

figure 2. IGBT

Typical output characteristics

$$I_C = f(V_{CE})$$

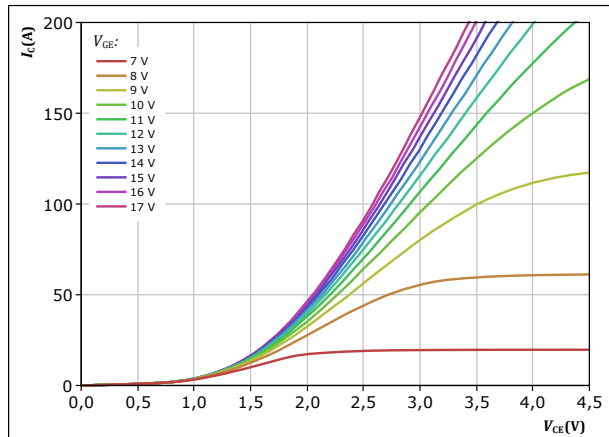

$t_p = 250 \mu s$
 $T_j = 150 \text{ °C}$
 V_{GE} from 7 V to 17 V in steps of 1 V

figure 3. IGBT

Typical transfer characteristics

$$I_C = f(V_{GE})$$

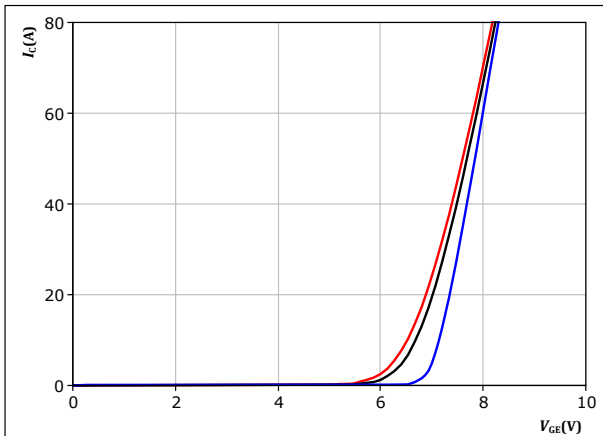

$t_p = 250 \mu s$
 $V_{CE} = 59 V$
 $T_j:$ — 25 °C
— 125 °C
— 150 °C

figure 4. IGBT

Transient thermal impedance as a function of pulse width

$$Z_{th(j-s)} = f(t_p)$$

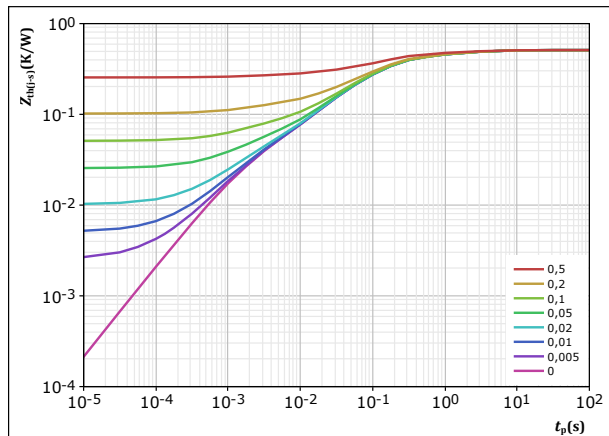

$D = t_p / T$
 $R_{th(j-s)} = 0,51 \text{ K/W}$
IGBT thermal model values

| R (K/W) | τ (s) |
|----------|------------|
| 4,69E-02 | 3,44E+00 |
| 9,41E-02 | 5,98E-01 |
| 2,77E-01 | 1,08E-01 |
| 6,79E-02 | 1,98E-02 |
| 2,44E-02 | 1,61E-03 |



Buck Switch Characteristics

figure 5. IGBT

Safe operating area
 $I_C = f(V_{CE})$

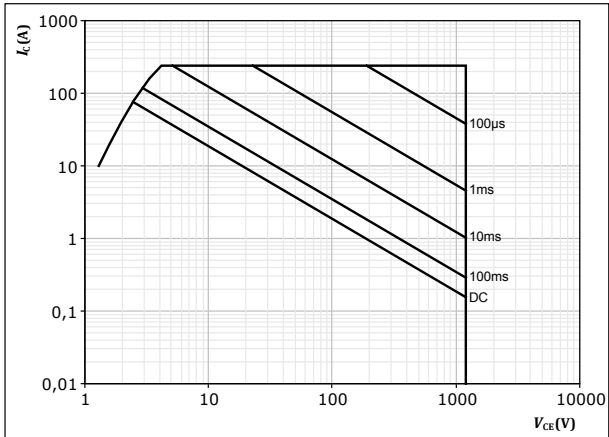

$D =$ single pulse
 $T_s = 80 \text{ } ^\circ\text{C}$
 $V_{GE} = 15 \text{ V}$
 $T_j = T_{jmax}$

figure 6. IGBT

Gate voltage vs gate charge
 $V_{GE} = f(Q_g)$

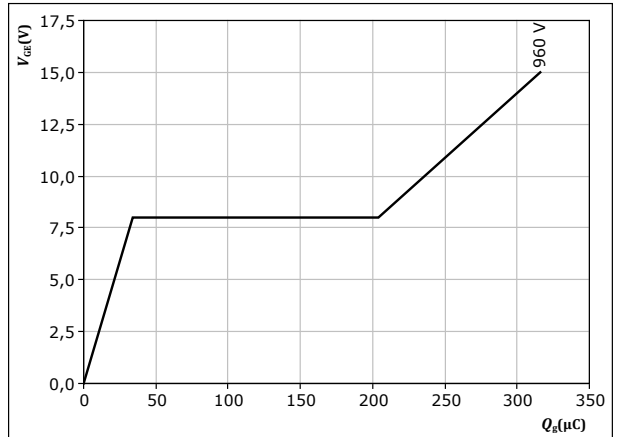

$I_C = 40 \text{ A}$
 $T_j = 25 \text{ } ^\circ\text{C}$



Buck Diode Characteristics

figure 7. FWD

Typical forward characteristics

$$I_F = f(V_F)$$

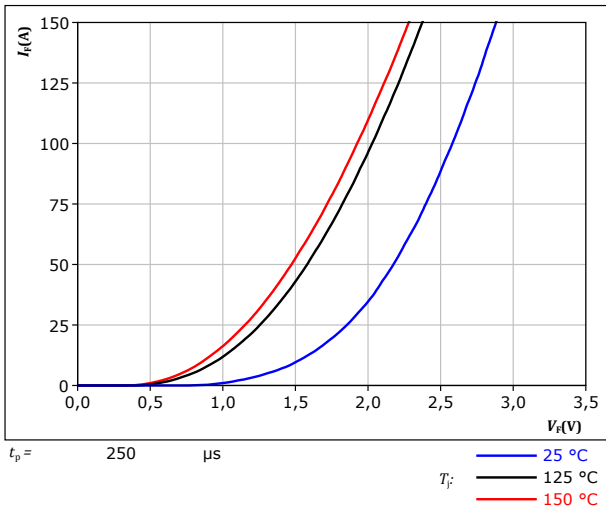
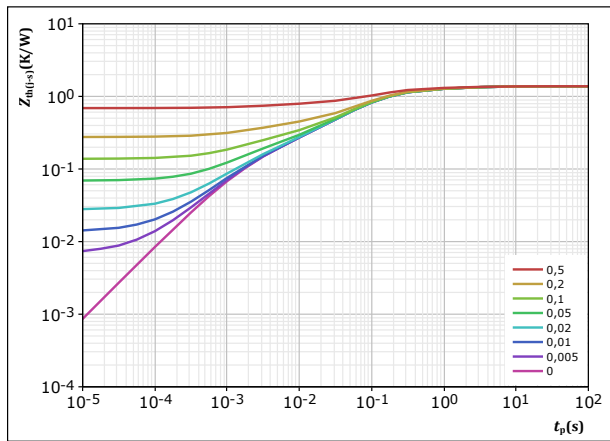

figure 8. FWD

Transient thermal impedance as a function of pulse width

$$Z_{th(j-s)} = f(t_p)$$



$D = \frac{t_p}{T}$
 $R_{th(j-s)} = 1,379 \text{ K/W}$
 FWD thermal model values

| R (K/W) | τ (s) |
|----------|------------|
| 8,16E-02 | 3,99E+00 |
| 2,02E-01 | 6,32E-01 |
| 7,09E-01 | 1,11E-01 |
| 2,16E-01 | 3,68E-02 |
| 9,74E-02 | 5,31E-03 |
| 7,28E-02 | 1,31E-03 |



Boost Switch Characteristics

figure 9. IGBT

Typical output characteristics

$$I_C = f(V_{CE})$$

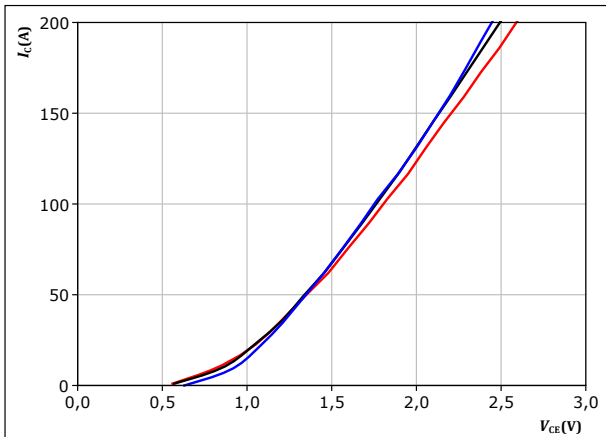

$t_p = 250 \mu s$
 $V_{GE} = 15 V$
 $T_j:$ 25 °C, 125 °C, 150 °C

figure 10. IGBT

Typical output characteristics

$$I_C = f(V_{CE})$$

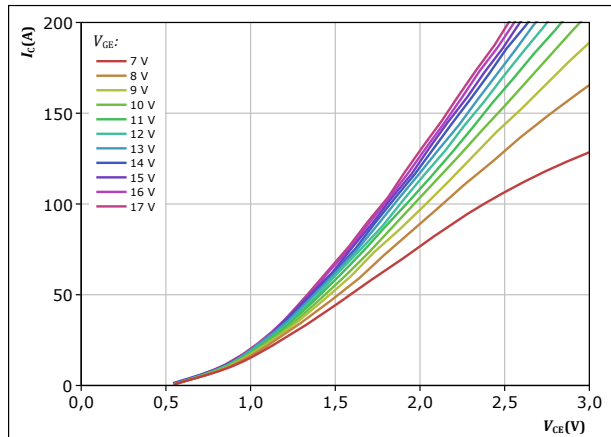

$t_p = 250 \mu s$
 $T_j = 150 \text{ °C}$
 V_{GE} from 7 V to 17 V in steps of 1 V

figure 11. IGBT

Typical transfer characteristics

$$I_C = f(V_{GE})$$

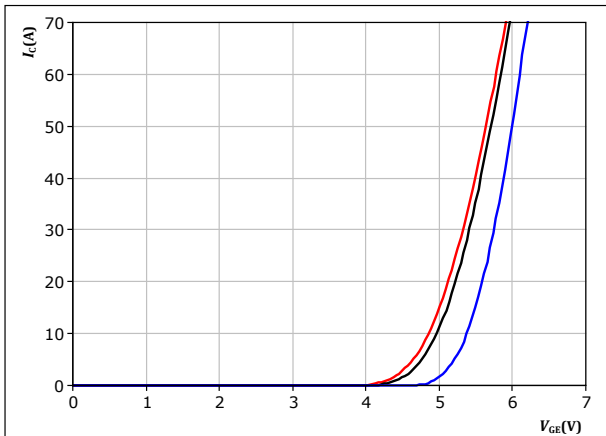

$t_p = 250 \mu s$
 $V_{CE} = 10 V$
 $T_j:$ 25 °C, 125 °C, 150 °C

figure 12. IGBT

Transient thermal impedance as a function of pulse width

$$Z_{th(j-s)} = f(t_p)$$

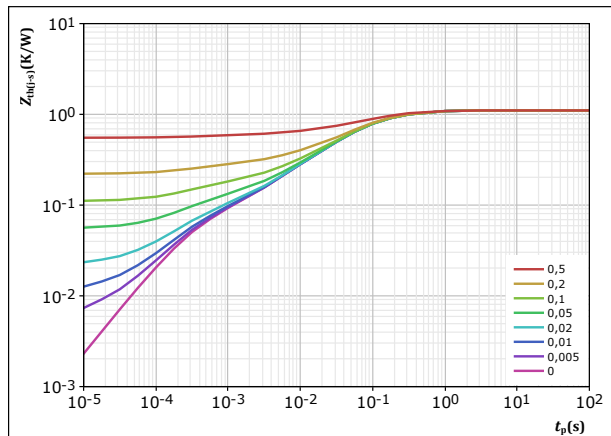

$D = t_p / T$
 $R_{th(j-s)} = 1,104 \text{ K/W}$
IGBT thermal model values

| R (K/W) | τ (s) |
|----------|------------|
| 2,16E-01 | 4,05E-01 |
| 6,30E-01 | 6,87E-02 |
| 1,62E-01 | 1,13E-02 |
| 3,68E-02 | 2,51E-03 |
| 6,02E-02 | 3,09E-04 |



Boost Switch Characteristics

figure 13. IGBT

Safe operating area
 $I_C = f(V_{CE})$

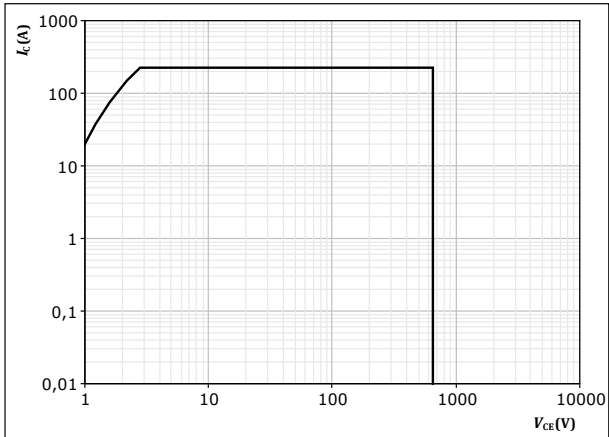

$D =$ single pulse
 $T_s = 80$ °C
 $V_{GE} = 15$ V
 $T_j = T_{jmax}$

figure 14. IGBT

Gate voltage vs gate charge
 $V_{GE} = f(Q_g)$

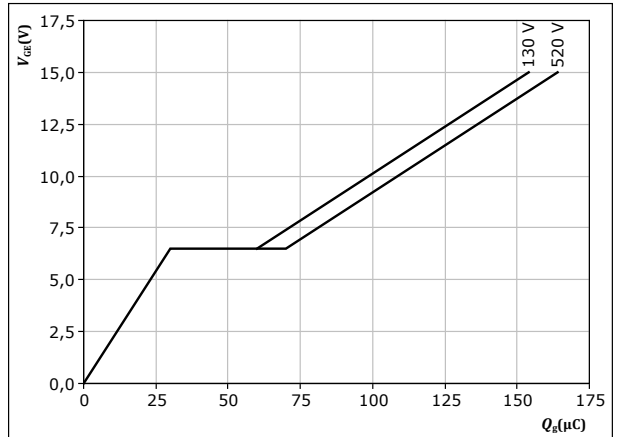

$I_C = 75$ A
 $T_j = 25$ °C



Boost Diode Characteristics

figure 15. FWD

Typical forward characteristics

$$I_F = f(V_F)$$

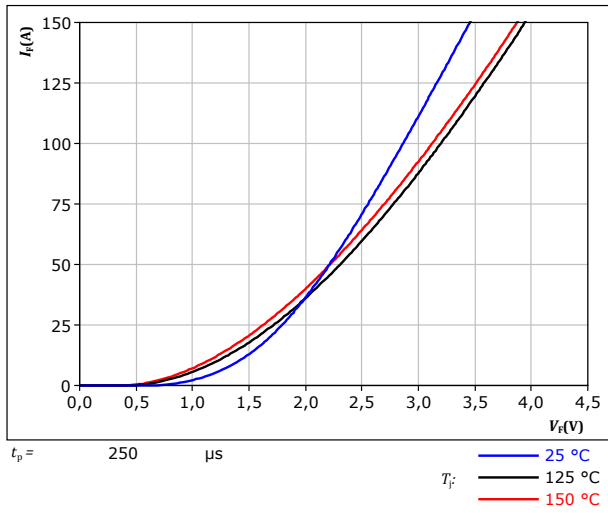
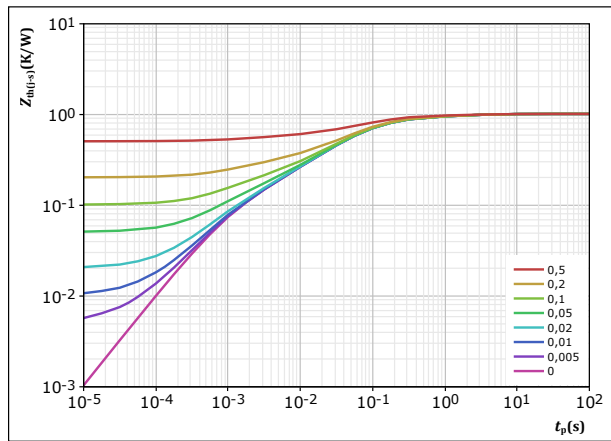

figure 16. FWD

Transient thermal impedance as a function of pulse width

$$Z_{th(j-s)} = f(t_p)$$



$D = t_p / T$
 $R_{th(j-s)} = 1,016$ K/W
 FWD thermal model values

| R (K/W) | τ (s) |
|----------|------------|
| 5,56E-02 | 3,42E+00 |
| 1,14E-01 | 5,52E-01 |
| 4,09E-01 | 9,78E-02 |
| 2,64E-01 | 3,21E-02 |
| 9,94E-02 | 6,42E-03 |
| 7,49E-02 | 9,84E-04 |



Thermistor Characteristics

figure 17. Thermistor

Typical NTC characteristic as function of temperature

$$R_T = f(T)$$

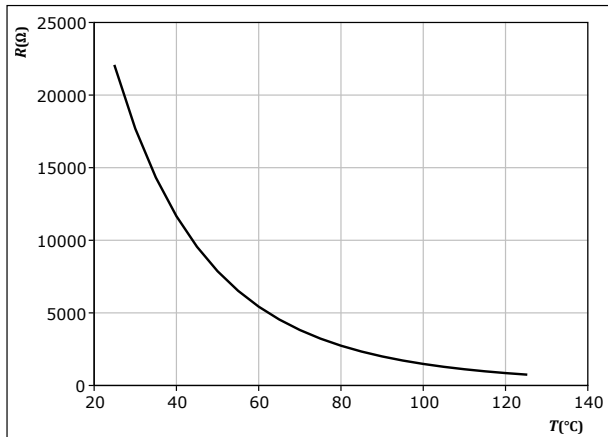



Buck Switching Characteristics

figure 18. IGBT

Typical switching energy losses as a function of collector current
 $E = f(I_c)$

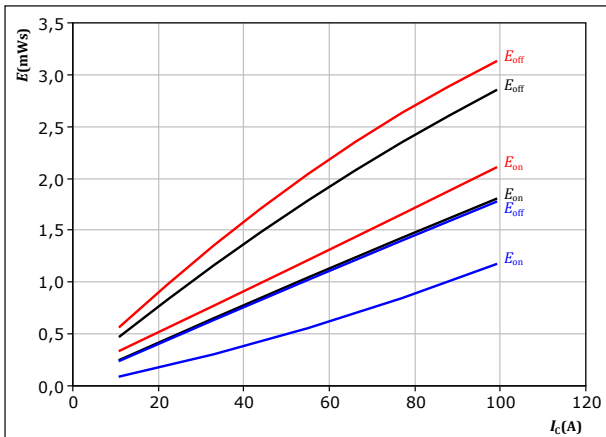

With an inductive load at

| | |
|---------------------|----------------|
| $V_{CE} = 350$ V | $T_j = 25$ °C |
| $V_{GE} = \pm 15$ V | $T_j = 125$ °C |
| $R_{g(on)} = 4$ Ω | $T_j = 150$ °C |
| $R_{g(off)} = 4$ Ω | |

figure 19. IGBT

Typical switching energy losses as a function of IGBT turn on gate resistor
 $E = f(R_g)$

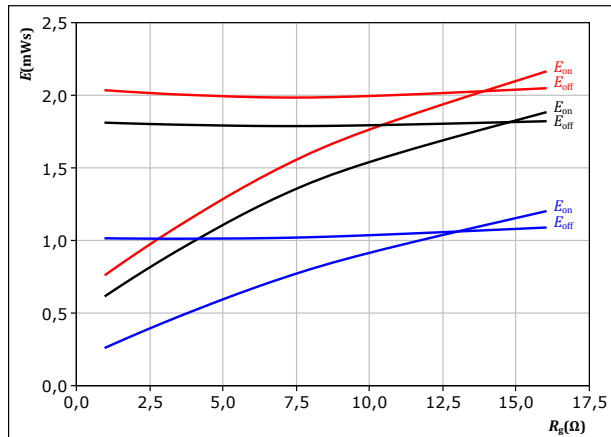

With an inductive load at

| | |
|---------------------|----------------|
| $V_{CE} = 350$ V | $T_j = 25$ °C |
| $V_{GE} = \pm 15$ V | $T_j = 125$ °C |
| $I_c = 55$ A | $T_j = 150$ °C |

figure 20. FWD

Typical reverse recovered energy loss as a function of collector current
 $E_{rec} = f(I_c)$

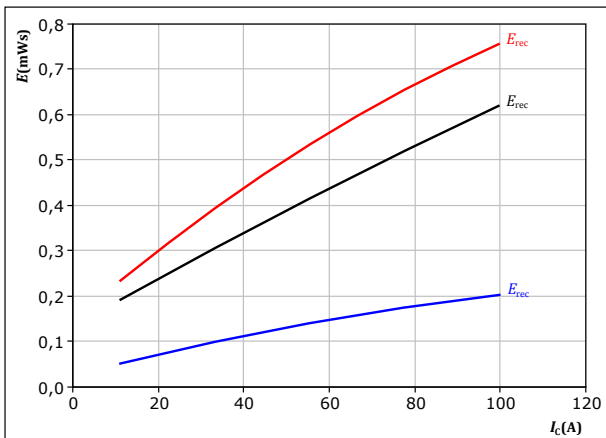

With an inductive load at

| | |
|---------------------|----------------|
| $V_{CE} = 350$ V | $T_j = 25$ °C |
| $V_{GE} = \pm 15$ V | $T_j = 125$ °C |
| $R_{g(on)} = 4$ Ω | $T_j = 150$ °C |

figure 21. FWD

Typical reverse recovered energy loss as a function of IGBT turn on gate resistor
 $E_{rec} = f(R_g)$

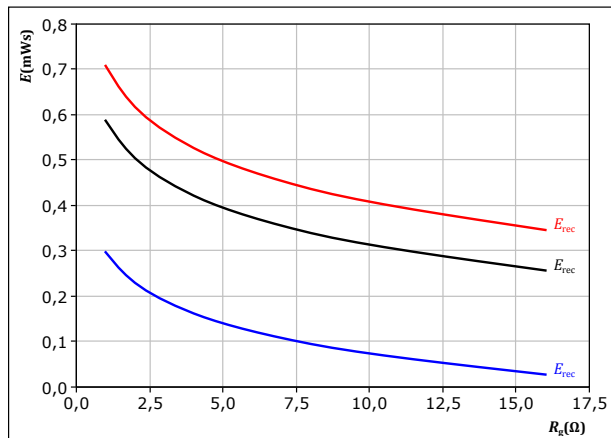

With an inductive load at

| | |
|---------------------|----------------|
| $V_{CE} = 350$ V | $T_j = 25$ °C |
| $V_{GE} = \pm 15$ V | $T_j = 125$ °C |
| $I_c = 55$ A | $T_j = 150$ °C |



Buck Switching Characteristics

figure 22. IGBT

Typical switching times as a function of collector current
 $t = f(I_c)$

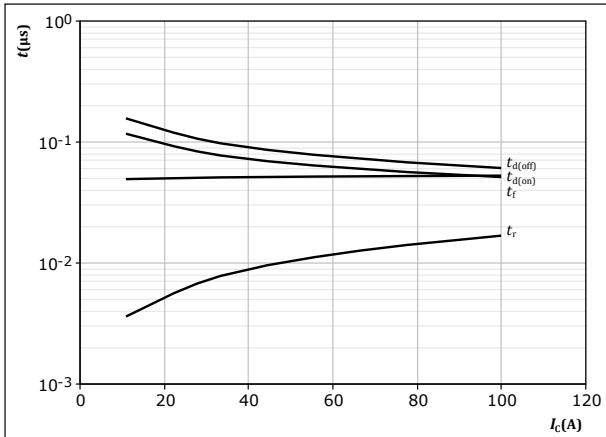

With an inductive load at
 $T_j = 150 \text{ } ^\circ\text{C}$
 $V_{CE} = 350 \text{ V}$
 $V_{GE} = \pm 15 \text{ V}$
 $R_{gon} = 4 \text{ } \Omega$
 $R_{goff} = 4 \text{ } \Omega$

figure 23. IGBT

Typical switching times as a function of IGBT turn on gate resistor
 $t = f(R_g)$

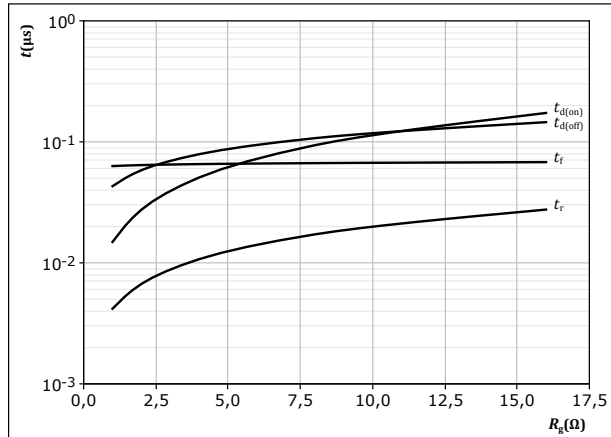

With an inductive load at
 $T_j = 150 \text{ } ^\circ\text{C}$
 $V_{CE} = 350 \text{ V}$
 $V_{GE} = \pm 15 \text{ V}$
 $I_c = 55 \text{ A}$

figure 24. FWD

Typical reverse recovery time as a function of collector current
 $t_{rr} = f(I_c)$

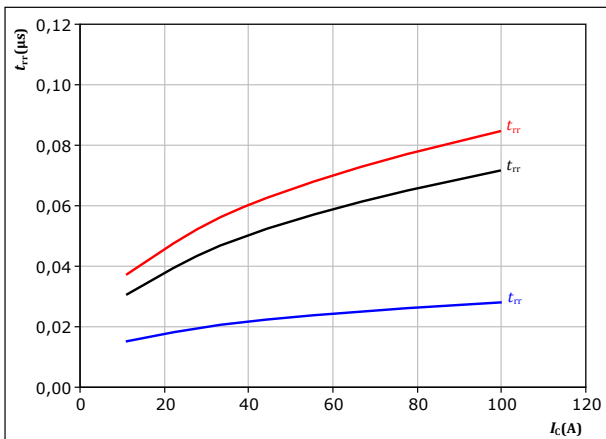

With an inductive load at
 $V_{CE} = 350 \text{ V}$
 $V_{GE} = \pm 15 \text{ V}$
 $R_{gon} = 4 \text{ } \Omega$

T_j :
— 25 °C
— 125 °C
— 150 °C

figure 25. FWD

Typical reverse recovery time as a function of IGBT turn on gate resistor
 $t_{rr} = f(R_{gon})$

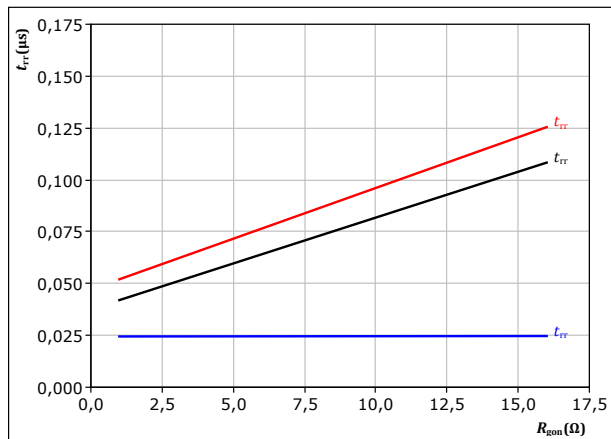

With an inductive load at
 $V_{CE} = 350 \text{ V}$
 $V_{GE} = \pm 15 \text{ V}$
 $I_c = 55 \text{ A}$

T_j :
— 25 °C
— 125 °C
— 150 °C



Buck Switching Characteristics

figure 26. FWD

Typical recovered charge as a function of collector current

$$Q_r = f(I_c)$$

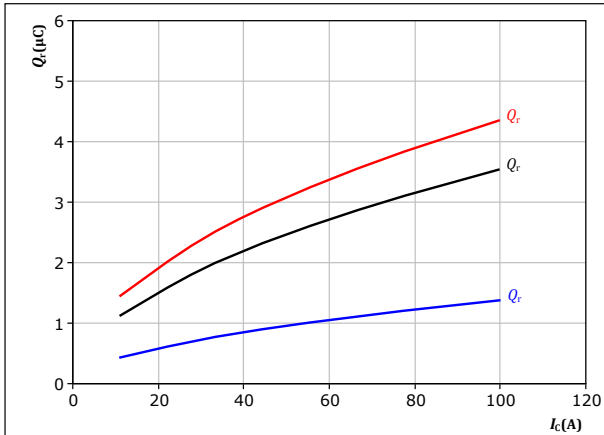

With an inductive load at

$V_{CE} = 350 \text{ V}$
 $V_{GE} = \pm 15 \text{ V}$
 $R_{gon} = 4 \ \Omega$
 $T_j: 25 \text{ }^\circ\text{C}$
 $125 \text{ }^\circ\text{C}$
 $150 \text{ }^\circ\text{C}$

figure 28. FWD

Typical peak reverse recovery current as a function of collector current

$$I_{RM} = f(I_c)$$

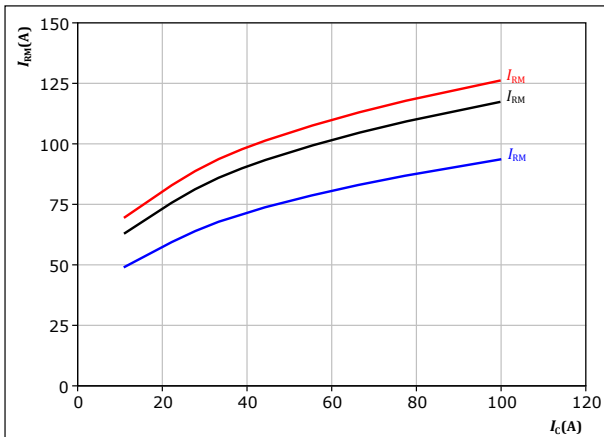

With an inductive load at

$V_{CE} = 350 \text{ V}$
 $V_{GE} = \pm 15 \text{ V}$
 $R_{gon} = 4 \ \Omega$
 $T_j: 25 \text{ }^\circ\text{C}$
 $125 \text{ }^\circ\text{C}$
 $150 \text{ }^\circ\text{C}$

figure 27. FWD

Typical recovered charge as a function of IGBT turn on gate resistor

$$Q_r = f(R_{gon})$$

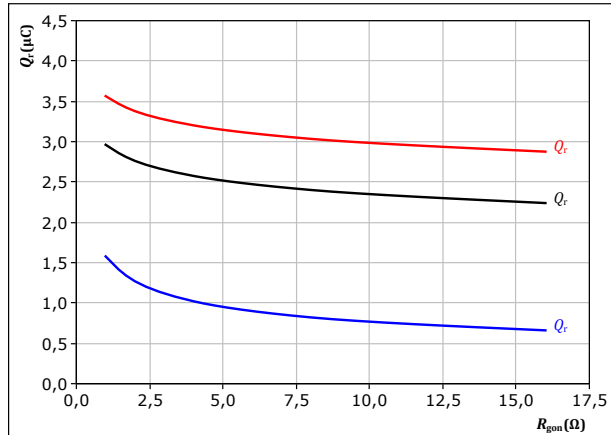

With an inductive load at

$V_{CE} = 350 \text{ V}$
 $V_{GE} = \pm 15 \text{ V}$
 $I_c = 55 \text{ A}$
 $T_j: 25 \text{ }^\circ\text{C}$
 $125 \text{ }^\circ\text{C}$
 $150 \text{ }^\circ\text{C}$

figure 29. FWD

Typical peak reverse recovery current as a function of IGBT turn on gate resistor

$$I_{RM} = f(R_{gon})$$

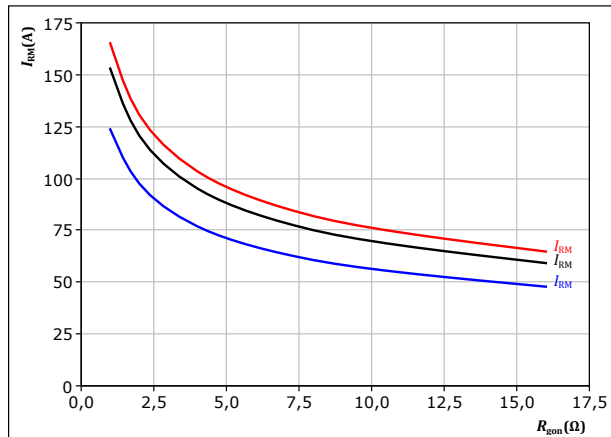

With an inductive load at

$V_{CE} = 350 \text{ V}$
 $V_{GE} = \pm 15 \text{ V}$
 $I_c = 55 \text{ A}$
 $T_j: 25 \text{ }^\circ\text{C}$
 $125 \text{ }^\circ\text{C}$
 $150 \text{ }^\circ\text{C}$



Buck Switching Characteristics

figure 30. FWD

Typical rate of fall of forward and reverse recovery current as a function of collector current
 $di_f/dt, di_r/dt = f(I_C)$

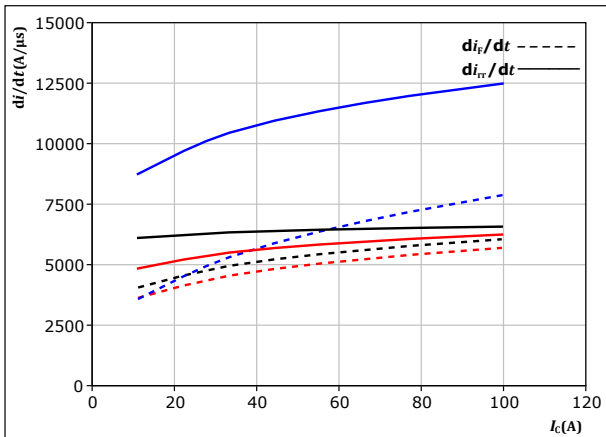

With an inductive load at

$V_{CE} = 350 \text{ V}$
 $V_{GE} = \pm 15 \text{ V}$
 $R_{gon} = 4 \ \Omega$

$T_j = 25 \text{ }^\circ\text{C}$ (blue line)
 $125 \text{ }^\circ\text{C}$ (black line)
 $150 \text{ }^\circ\text{C}$ (red line)

figure 31. FWD

Typical rate of fall of forward and reverse recovery current as a function of turn on gate resistor
 $di_f/dt, di_r/dt = f(R_{gon})$

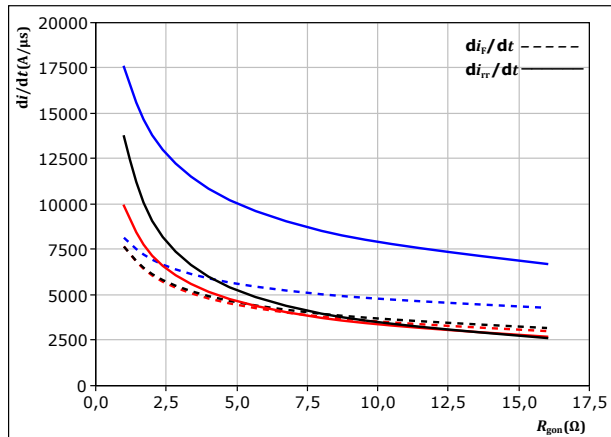

With an inductive load at

$V_{CE} = 350 \text{ V}$
 $V_{GE} = \pm 15 \text{ V}$
 $I_C = 55 \text{ A}$

$T_j = 25 \text{ }^\circ\text{C}$ (blue line)
 $125 \text{ }^\circ\text{C}$ (black line)
 $150 \text{ }^\circ\text{C}$ (red line)

figure 32. IGBT

Reverse bias safe operating area

$I_C = f(V_{CE})$

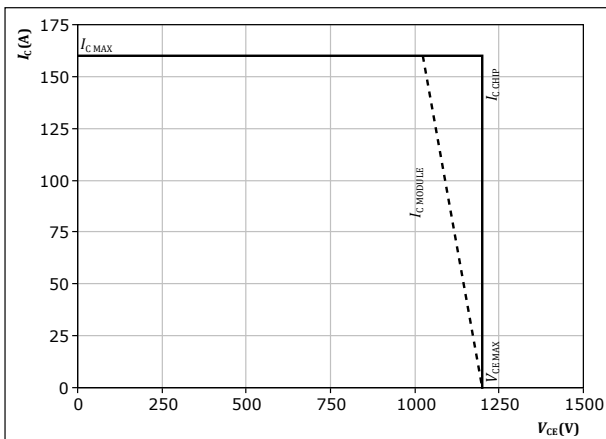

At $T_j = 150 \text{ }^\circ\text{C}$
 $R_{gon} = 4 \ \Omega$
 $R_{goff} = 4 \ \Omega$



Boost Switching Characteristics

figure 33. IGBT

Typical switching energy losses as a function of collector current
 $E = f(I_c)$

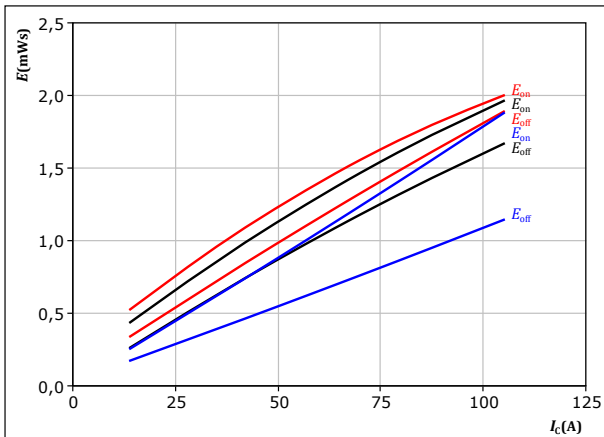

With an inductive load at

| | |
|---------------------|---------------|
| $V_{CE} = 350$ V | $T_j: 25$ °C |
| $V_{GE} = \pm 15$ V | $T_j: 125$ °C |
| $R_{g(on)} = 16$ Ω | $T_j: 150$ °C |
| $R_{g(off)} = 16$ Ω | |

figure 34. IGBT

Typical switching energy losses as a function of IGBT turn on gate resistor
 $E = f(R_g)$

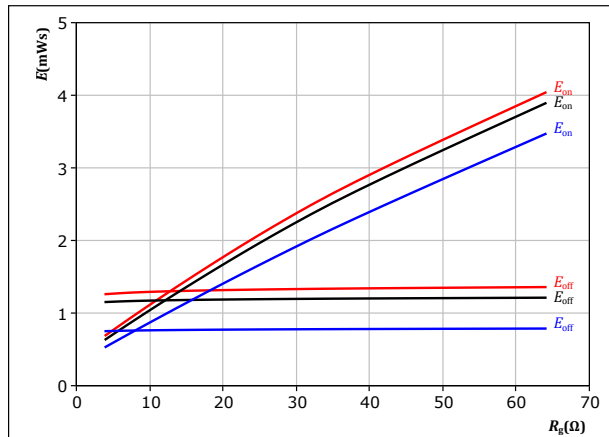

With an inductive load at

| | |
|---------------------|---------------|
| $V_{CE} = 350$ V | $T_j: 25$ °C |
| $V_{GE} = \pm 15$ V | $T_j: 125$ °C |
| $I_c = 70$ A | $T_j: 150$ °C |

figure 35. FWD

Typical reverse recovered energy loss as a function of collector current
 $E_{rec} = f(I_c)$

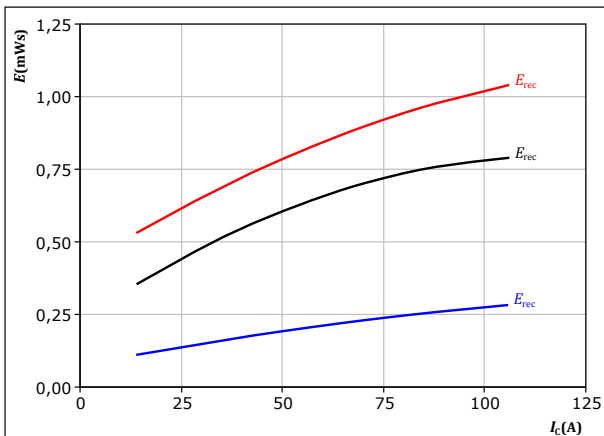

With an inductive load at

| | |
|---------------------|---------------|
| $V_{CE} = 350$ V | $T_j: 25$ °C |
| $V_{GE} = \pm 15$ V | $T_j: 125$ °C |
| $R_{g(on)} = 16$ Ω | $T_j: 150$ °C |

figure 36. FWD

Typical reverse recovered energy loss as a function of IGBT turn on gate resistor
 $E_{rec} = f(R_g)$

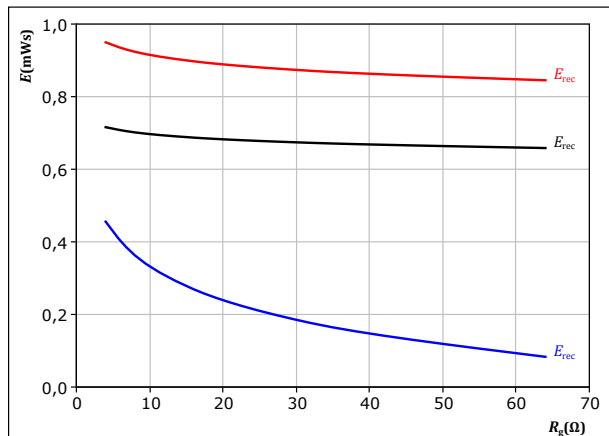

With an inductive load at

| | |
|---------------------|---------------|
| $V_{CE} = 350$ V | $T_j: 25$ °C |
| $V_{GE} = \pm 15$ V | $T_j: 125$ °C |
| $I_c = 70$ A | $T_j: 150$ °C |



Boost Switching Characteristics

figure 37. IGBT

Typical switching times as a function of collector current
 $t = f(I_c)$

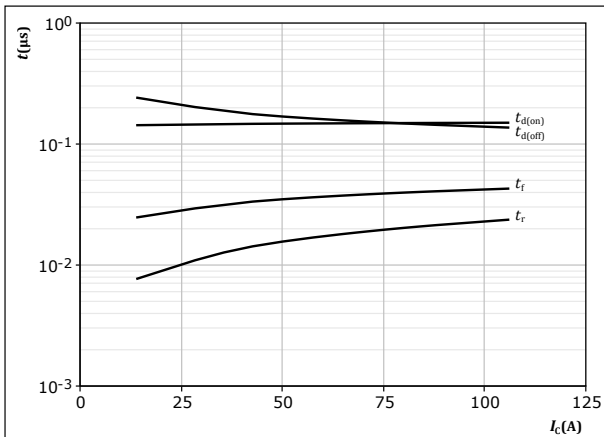

With an inductive load at
 $T_j = 150 \text{ }^\circ\text{C}$
 $V_{CE} = 350 \text{ V}$
 $V_{GE} = \pm 15 \text{ V}$
 $R_{gon} = 16 \text{ } \Omega$
 $R_{goff} = 16 \text{ } \Omega$

figure 38. IGBT

Typical switching times as a function of IGBT turn on gate resistor
 $t = f(R_g)$

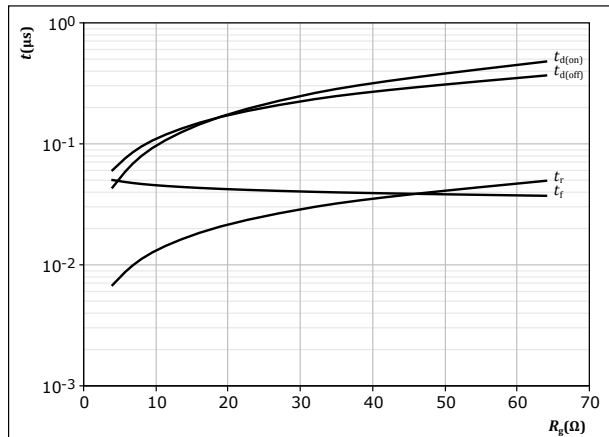

With an inductive load at
 $T_j = 150 \text{ }^\circ\text{C}$
 $V_{CE} = 350 \text{ V}$
 $V_{GE} = \pm 15 \text{ V}$
 $I_c = 70 \text{ A}$

figure 39. FWD

Typical reverse recovery time as a function of collector current
 $t_{rr} = f(I_c)$

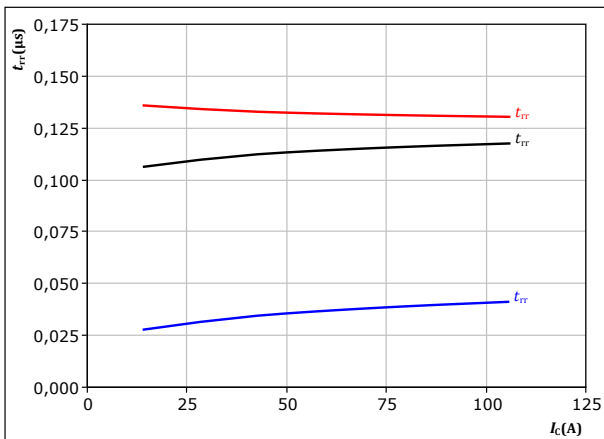

With an inductive load at
 $V_{CE} = 350 \text{ V}$
 $V_{GE} = \pm 15 \text{ V}$
 $R_{gon} = 16 \text{ } \Omega$
 $T_j:$ — 25 $^\circ\text{C}$
 — 125 $^\circ\text{C}$
 — 150 $^\circ\text{C}$

figure 40. FWD

Typical reverse recovery time as a function of IGBT turn on gate resistor
 $t_{rr} = f(R_{gon})$

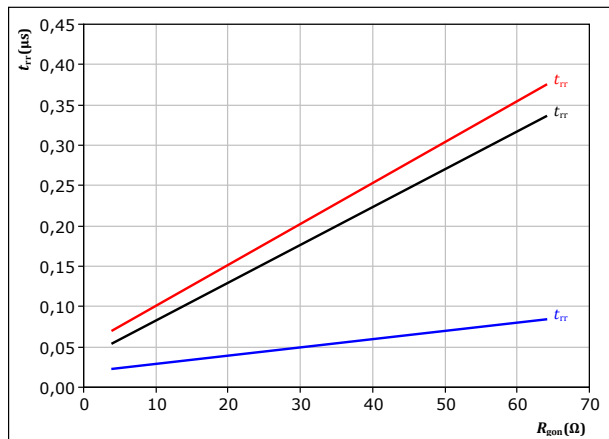

With an inductive load at
 $V_{CE} = 350 \text{ V}$
 $V_{GE} = \pm 15 \text{ V}$
 $I_c = 70 \text{ A}$
 $T_j:$ — 25 $^\circ\text{C}$
 — 125 $^\circ\text{C}$
 — 150 $^\circ\text{C}$



Boost Switching Characteristics

figure 41. FWD

Typical recovered charge as a function of collector current

$$Q_r = f(I_c)$$

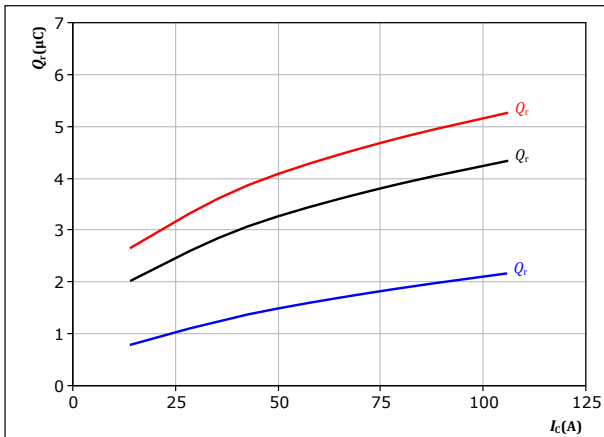

With an inductive load at

$V_{CE} = 350 \text{ V}$
 $V_{GE} = \pm 15 \text{ V}$
 $R_{gon} = 16 \ \Omega$

T_j : — 25 °C
— 125 °C
— 150 °C

figure 42. FWD

Typical recovered charge as a function of IGBT turn on gate resistor

$$Q_r = f(R_{gon})$$

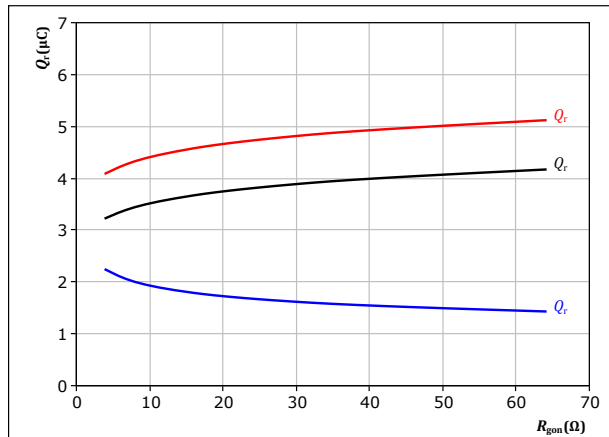

With an inductive load at

$V_{CE} = 350 \text{ V}$
 $V_{GE} = \pm 15 \text{ V}$
 $I_c = 70 \text{ A}$

T_j : — 25 °C
— 125 °C
— 150 °C

figure 43. FWD

Typical peak reverse recovery current as a function of collector current

$$I_{RM} = f(I_c)$$

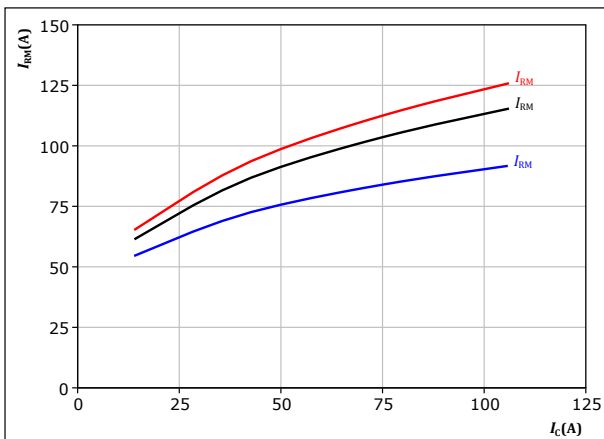

With an inductive load at

$V_{CE} = 350 \text{ V}$
 $V_{GE} = \pm 15 \text{ V}$
 $R_{gon} = 16 \ \Omega$

T_j : — 25 °C
— 125 °C
— 150 °C

figure 44. FWD

Typical peak reverse recovery current as a function of IGBT turn on gate resistor

$$I_{RM} = f(R_{gon})$$

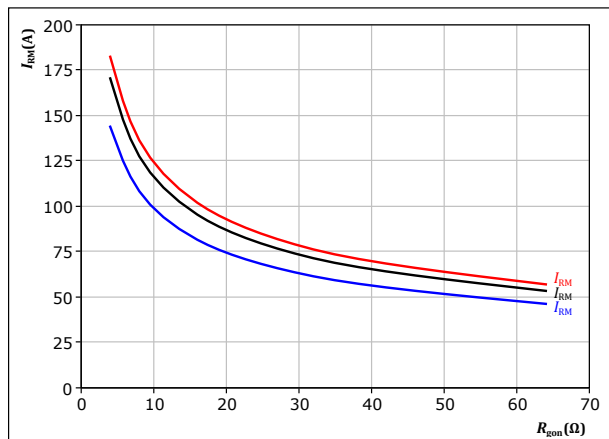

With an inductive load at

$V_{CE} = 350 \text{ V}$
 $V_{GE} = \pm 15 \text{ V}$
 $I_c = 70 \text{ A}$

T_j : — 25 °C
— 125 °C
— 150 °C



Boost Switching Characteristics

figure 45. FWD

Typical rate of fall of forward and reverse recovery current as a function of collector current
 $di_f/dt, di_r/dt = f(I_C)$

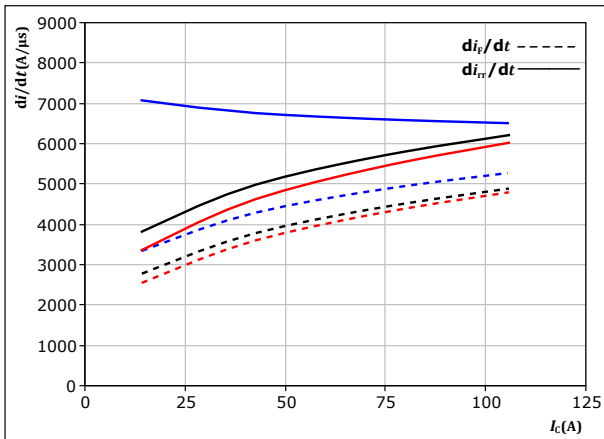

With an inductive load at

$V_{CE} = 350$ V
 $V_{GE} = \pm 15$ V
 $R_{gon} = 16$ Ω

$T_j = 25$ °C
 — 125 °C
 — 150 °C

figure 46. FWD

Typical rate of fall of forward and reverse recovery current as a function of turn on gate resistor
 $di_f/dt, di_r/dt = f(R_{gon})$

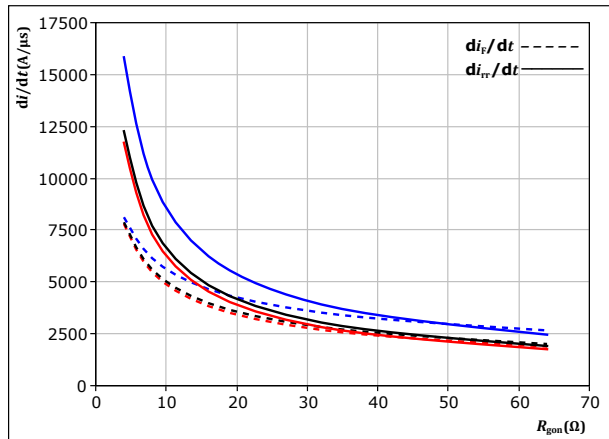

With an inductive load at

$V_{CE} = 350$ V
 $V_{GE} = \pm 15$ V
 $I_C = 70$ A

$T_j = 25$ °C
 — 125 °C
 — 150 °C

figure 47. IGBT

Reverse bias safe operating area

$I_C = f(V_{CE})$

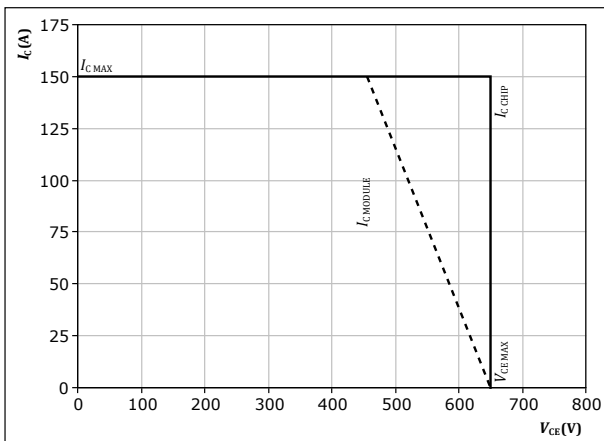

At $T_j = 150$ °C
 $R_{gon} = 16$ Ω
 $R_{goff} = 16$ Ω



Switching Definitions

figure 48. IGBT

Turn-off Switching Waveforms & definition of t_{doff} , t_{Eoff} (t_{Eoff} = integrating time for E_{off})

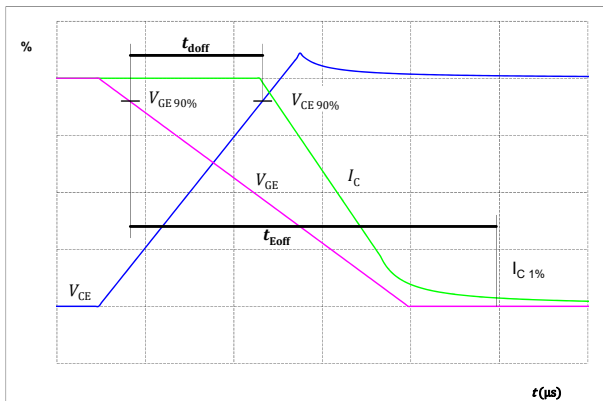

figure 49. IGBT

Turn-on Switching Waveforms & definition of t_{don} , t_{Eon} (t_{Eon} = integrating time for E_{on})

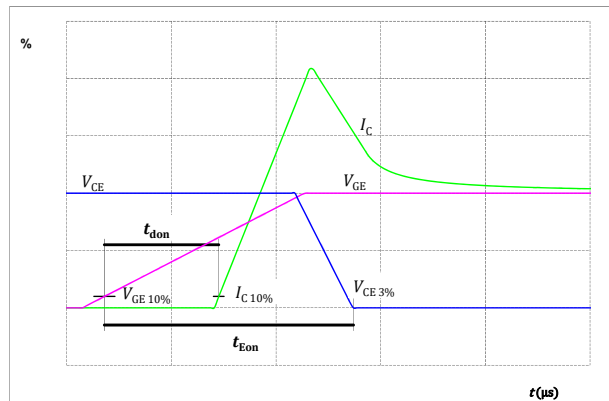

figure 50. IGBT

Turn-off Switching Waveforms & definition of t_f

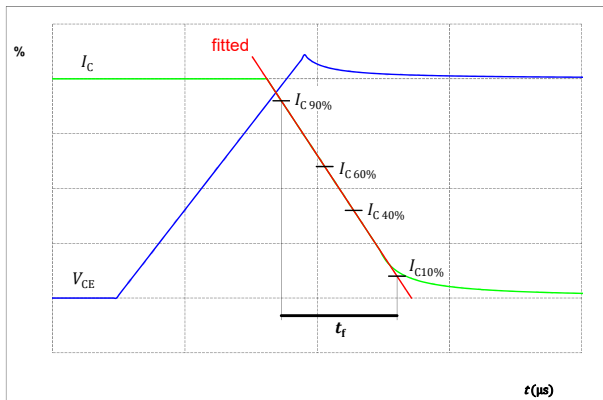
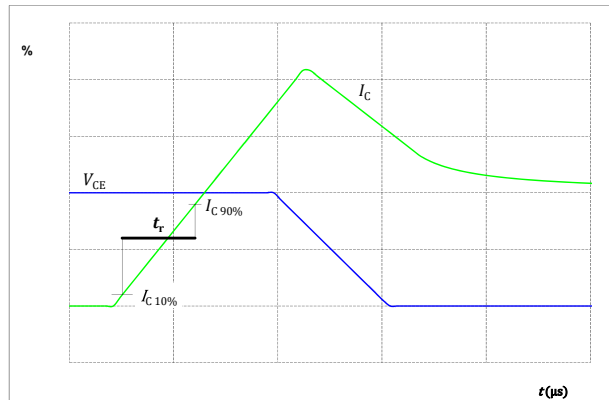

figure 51. IGBT

Turn-on Switching Waveforms & definition of t_r





Switching Definitions

figure 52. FWD

Turn-off Switching Waveforms & definition of t_{rr}

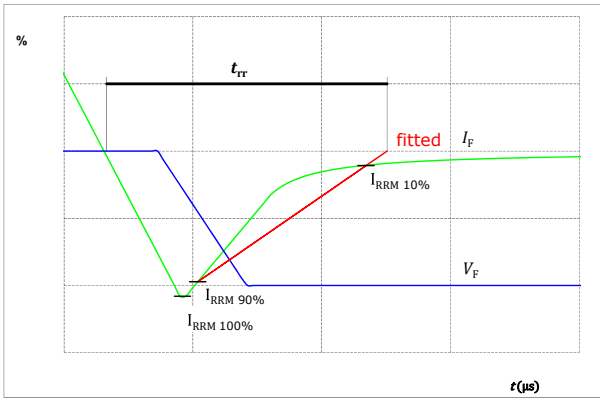
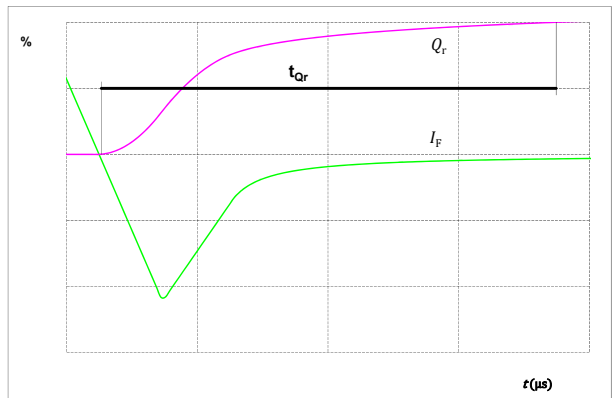

figure 53. FWD

Turn-on Switching Waveforms & definition of t_{Qr} (t_{Qr} = integrating time for Q_r)





Vincotech

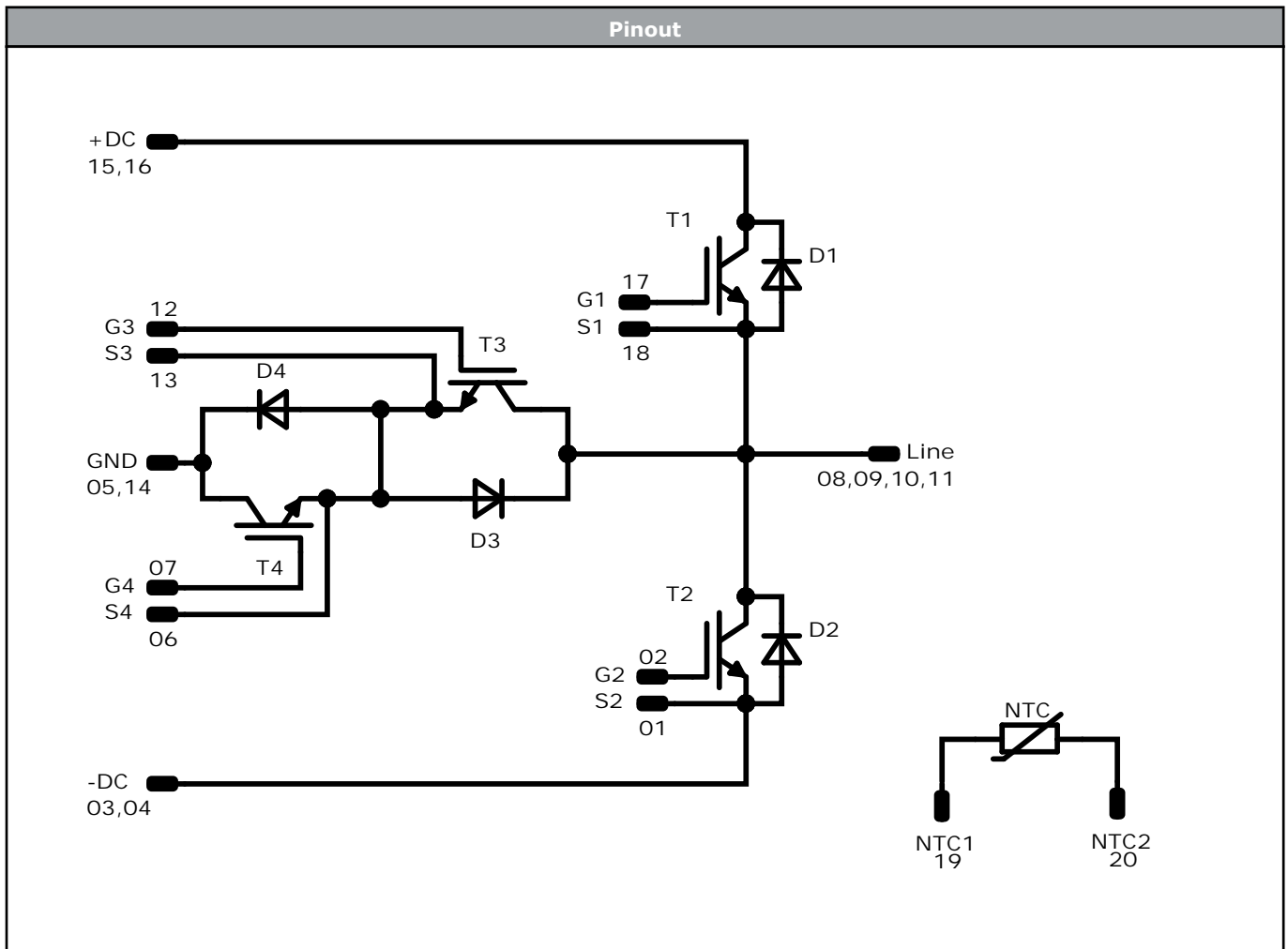

| Identification | | | | | |
|------------------|------------|---------|---------|--------------|---------|
| ID | Component | Voltage | Current | Function | Comment |
| T1_1, 2, T2_1, 2 | IGBT | 1200 V | 80 A | Buck Switch | |
| D3, D4 | FWD | 600 V | 60 A | Buck Diode | |
| T3, T4 | IGBT | 650 V | 75 A | Boost Switch | |
| D1, D2 | FWD | 1200 V | 50 A | Boost Diode | |
| NTC | Thermistor | | | Thermistor | |



| Packaging instruction | | | | |
|---------------------------------------|------|----------|------|--------|
| Standard packaging quantity (SPQ) 135 | >SPQ | Standard | <SPQ | Sample |

| Handling instruction |
|-----------------------------------------------------------------------------|
| Handling instructions for <i>flow 0</i> packages see vincotech.com website. |

| Package data |
|--------------------------------------------------------------------|
| Package data for <i>flow 0</i> packages see vincotech.com website. |

| Vincotech thermistor reference |
|--------------------------------------------------------------------|
| See Vincotech thermistor reference table at vincotech.com website. |

| UL recognition and file number |
|---------------------------------------------------------------------------------------------------------------------------------------------------------------------------------------------------------------------|
| This device is certified according to UL 1557 standard, UL file number E192116. For more information see vincotech.com website.  |

| Document No.: | Date: | Modification: | Pages |
|---------------------------------|--------------|---------------|-------|
| 10-FZ12NMA080F205-M260F53-D1-14 | 12 Jul. 2022 | | |

DISCLAIMER

The information, specifications, procedures, methods and recommendations herein (together "information") are presented by Vincotech to reader in good faith, are believed to be accurate and reliable, but may well be incomplete and/or not applicable to all conditions or situations that may exist or occur. Vincotech reserves the right to make any changes without further notice to any products to improve reliability, function or design. No representation, guarantee or warranty is made to reader as to the accuracy, reliability or completeness of said information or that the application or use of any of the same will avoid hazards, accidents, losses, damages or injury of any kind to persons or property or that the same will not infringe third parties rights or give desired results. It is reader's sole responsibility to test and determine the suitability of the information and the product for reader's intended use.

LIFE SUPPORT POLICY

Vincotech products are not authorised for use as critical components in life support devices or systems without the express written approval of Vincotech.

As used herein:

1. Life support devices or systems are devices or systems which, (a) are intended for surgical implant into the body, or (b) support or sustain life, or (c) whose failure to perform when properly used in accordance with instructions for use provided in labelling can be reasonably expected to result in significant injury to the user.
2. A critical component is any component of a life support device or system whose failure to perform can be reasonably expected to cause the failure of the life support device or system, or to affect its safety or effectiveness.

单击下面可查看定价，库存，交付和生命周期等信息

[>>Vincotech\(威科\)](#)