

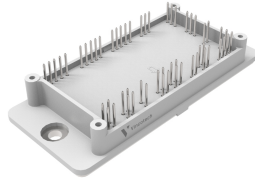

flowPIM 2		1200 V / 35 A	
Features <ul style="list-style-type: none">• Three-phase rectifier, BRC, Inverter, NTC• Very Compact housing, easy to route• IGBT4/ EmCon4 technology for low saturation losses and improved EMC behavior		flow 2 17 mm housing 	
Target applications <ul style="list-style-type: none">• Motor Drives• Power Generation		Schematic 	
Types <ul style="list-style-type: none">• V23990-P767-A-PM			

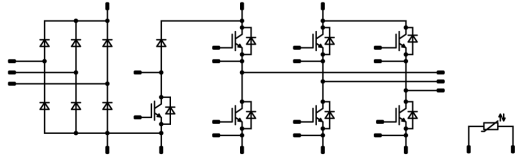

Vincotech

Maximum Ratings

$T_j = 25\text{ °C}$, unless otherwise specified

Parameter	Symbol	Conditions	Value	Unit
Inverter Switch				
Collector-emitter voltage	V_{CES}		1200	V
Collector current (DC current)	I_C	$T_j = T_{jmax}$ $T_s = 80\text{ °C}$	47	A
Repetitive peak collector current	I_{CRM}	t_p limited by T_{jmax}	105	A
Total power dissipation	P_{tot}	$T_j = T_{jmax}$ $T_s = 80\text{ °C}$	135	W
Gate-emitter voltage	V_{GES}		± 20	V
Short circuit ratings	t_{SC}	$V_{GE} = 15\text{ V}$, $V_{CC} = 800\text{ V}$ $T_j = 150\text{ °C}$	10	μs
Maximum junction temperature	T_{jmax}		175	$^{\circ}\text{C}$

Inverter Diode				
Peak repetitive reverse voltage	V_{RRM}		1200	V
Forward current (DC current)	I_F	$T_j = T_{jmax}$ $T_s = 80\text{ °C}$	51	A
Repetitive peak forward current	I_{FRM}	t_p limited by T_{jmax}	70	A
Total power dissipation	P_{tot}	$T_j = T_{jmax}$ $T_s = 80\text{ °C}$	103	W
Maximum junction temperature	T_{jmax}		175	$^{\circ}\text{C}$

Brake Switch				
Collector-emitter voltage	V_{CES}		1200	V
Collector current (DC current)	I_C	$T_j = T_{jmax}$ $T_s = 80\text{ °C}$	34	A
Repetitive peak collector current	I_{CRM}	t_p limited by T_{jmax}	75	A
Total power dissipation	P_{tot}	$T_j = T_{jmax}$ $T_s = 80\text{ °C}$	99	W
Gate-emitter voltage	V_{GES}		± 20	V
Short circuit ratings	t_{SC}	$V_{GE} = 15\text{ V}$, $V_{CC} = 800\text{ V}$ $T_j = 150\text{ °C}$	10	μs
Maximum junction temperature	T_{jmax}		175	$^{\circ}\text{C}$



Vincotech

Maximum Ratings

$T_j = 25\text{ °C}$, unless otherwise specified

Parameter	Symbol	Conditions	Value	Unit
Brake Diode				
Peak repetitive reverse voltage	V_{RRM}		1200	V
Forward current (DC current)	I_F	$T_j = T_{jmax}$ $T_s = 80\text{ °C}$	37	A
Repetitive peak forward current	I_{FRM}	t_p limited by T_{jmax}	50	A
Total power dissipation	P_{tot}	$T_j = T_{jmax}$ $T_s = 80\text{ °C}$	87	W
Maximum junction temperature	T_{jmax}		175	°C

Brake Sw. Protection Diode

Peak repetitive reverse voltage	V_{RRM}		1200	V
Forward current (DC current)	I_F	$T_j = T_{jmax}$ $T_s = 80\text{ °C}$	21	A
Repetitive peak forward current	I_{FRM}	t_p limited by T_{jmax}	20	A
Total power dissipation	P_{tot}	$T_j = T_{jmax}$ $T_s = 80\text{ °C}$	56	W
Maximum junction temperature	T_{jmax}		175	°C

Rectifier Diode

Peak repetitive reverse voltage	V_{RRM}		1600	V
Forward current (DC current)	I_F	$T_j = T_{jmax}$ $T_s = 80\text{ °C}$	86	A
Surge (non-repetitive) forward current	I_{FSM}	Single Half Sine Wave, $t_p = 10\text{ ms}$ $T_j = 150\text{ °C}$	490	A
Surge current capability	I^2t		1200	A ² s
Total power dissipation	P_{tot}	$T_j = T_{jmax}$ $T_s = 80\text{ °C}$	106	W
Maximum junction temperature	T_{jmax}		150	°C



Maximum Ratings

$T_j = 25\text{ °C}$, unless otherwise specified

Parameter	Symbol	Conditions	Value	Unit
-----------	--------	------------	-------	------

Module Properties

Thermal Properties

Storage temperature	T_{stg}		-40...+125	°C
Operation temperature under switching condition	T_{jop}		-40...+($T_{jmax} - 25$)	°C

Isolation Properties

Isolation voltage	V_{isol}	DC Test Voltage* $t_p = 2\text{ s}$	6000	V
Isolation voltage	V_{isol}	AC Voltage $t_p = 1\text{ min}$	2500	V
Creepage distance			>12,7	mm
Clearance			12,01	mm
Comparative Tracking Index	CTI		≥ 200	

*100 % tested in production



Characteristic Values

Parameter	Symbol	Conditions					Values			Unit
		V_{GE} [V] V_{GS} [V]	V_{CE} [V] V_{DS} [V] V_F [V]	I_C [A] I_D [A] I_F [A]	T_j [°C]	Min	Typ	Max		

Inverter Switch

Static

Gate-emitter threshold voltage	$V_{GE(th)}$	$V_{CE} = V_{GE}$			0,0012	25	5,3	5,8	6,3	V
Collector-emitter saturation voltage	$V_{CE(sat)}$		15		35	25 125 150	1,58	1,87 2,18 2,28	2,07 ⁽¹⁾	V
Collector-emitter cut-off current	I_{CES}		0	1200		25			5	µA
Gate-emitter leakage current	I_{GES}		20	0		25			120	nA
Internal gate resistance	r_g							None		Ω
Input capacitance	C_{ies}	$f = 1 \text{ Mhz}$	0	25		25		2000		pF
Reverse transfer capacitance	C_{res}							70		pF
Gate charge	Q_g		15		0	25		270		nC

Thermal

Thermal resistance junction to sink ⁽²⁾	$R_{th(j-s)}$	$\lambda_{paste} = 3,4 \text{ W/mK}$ (PSX)						0,7		K/W
--	---------------	---	--	--	--	--	--	-----	--	-----

Dynamic

Turn-on delay time	$t_{d(on)}$	$R_{gon} = 16 \Omega$ $R_{goff} = 16 \Omega$	±15	600	35	25		100,59		ns				
						125		100,69						
						150		100,49						
Rise time	t_r									25		27,6		ns
						125		29,5						
						150		29,97						
Turn-off delay time	$t_{d(off)}$									25		204,43		ns
						125		267,64						
						150		285,09						
Fall time	t_f									25		93,84		ns
						125		160,76						
						150		178,04						
Turn-on energy (per pulse)	E_{on}	$Q_{tFWD} = 2,56 \mu\text{C}$ $Q_{tFWD} = 4,92 \mu\text{C}$ $Q_{tFWD} = 5,7 \mu\text{C}$				25		2,15		mWs				
						125		3,15						
						150		3,45						
Turn-off energy (per pulse)	E_{off}					25		1,95		mWs				
						125		2,97						
						150		3,34						



Vincotech

V23990-P767-A-PM
datasheet

Characteristic Values

Parameter	Symbol	Conditions					Values			Unit
		V_{GE} [V] V_{GS} [V]	V_{CE} [V] V_{DS} [V] V_F [V]	I_C [A] I_D [A] I_F [A]	T_j [°C]	Min	Typ	Max		
Inverter Diode										
Static										
Forward voltage	V_F				35	25 125 150	1,35	1,76 1,73 1,69	2,05 ⁽¹⁾	V
Reverse leakage current	I_R	$V_r = 1200$ V				25			7,7	μA
Thermal										
Thermal resistance junction to sink ⁽²⁾	$R_{th(j-s)}$	$\lambda_{paste} = 3,4$ W/mK (PSX)						0,92		K/W
Dynamic										
Peak recovery current	I_{RRM}					25 125 150		29,78 36,77 38,52		A
Reverse recovery time	t_{rr}					25 125 150		248,59 369,59 412,22		ns
Recovered charge	Q_r	$di/dt=1450$ A/μs $di/dt=1341$ A/μs $di/dt=1290$ A/μs	±15	600	35	25 125 150		2,56 4,92 5,7		μC
Reverse recovered energy	E_{rec}					25 125 150		0,918 1,83 2,14		mWs
Peak rate of fall of recovery current	$(di_r/dt)_{max}$					25 125 150		360,31 144,92 141,01		A/μs



Characteristic Values

Parameter	Symbol	Conditions					Values			Unit
		V_{GE} [V] V_{GS} [V]	V_{CE} [V] V_{DS} [V] V_F [V]	I_C [A] I_D [A] I_F [A]	T_j [°C]	Min	Typ	Max		

Brake Switch

Static

Gate-emitter threshold voltage	$V_{GE(th)}$	$V_{CE} = V_{GE}$			0,00085	25	5,3	5,8	6,3	V
Collector-emitter saturation voltage	$V_{CE(sat)}$		15		25	25 125 150	1,58	1,87 2,23	2,07 ⁽¹⁾	V
Collector-emitter cut-off current	I_{CES}		0	1200		25			2,4	μA
Gate-emitter leakage current	I_{GES}		20	0		25			120	nA
Internal gate resistance	r_g							None		Ω
Input capacitance	C_{ies}	$f = 1 \text{ Mhz}$	0	25		25		1450		pF
Reverse transfer capacitance	C_{res}							50		pF
Gate charge	Q_g		15		0	25		200		nC

Thermal

Thermal resistance junction to sink ⁽²⁾	$R_{th(j-s)}$	$\lambda_{paste} = 3,4 \text{ W/mK}$ (PSX)						0,96		K/W
--	---------------	---	--	--	--	--	--	------	--	-----

Dynamic

Turn-on delay time	$t_{d(on)}$	$R_{gon} = 32 \Omega$ $R_{goff} = 32 \Omega$	0/15	600	25	25		47,08		ns
Rise time	t_r					125		44,54	ns	
						150		43,99		
						25		39,68		
Turn-off delay time	$t_{d(off)}$					125		42,08	ns	
						150		42,86		
						25		366,18		
Fall time	t_f					125		425,59	ns	
						150		443,1		
		25		108,25						
Turn-on energy (per pulse)	E_{on}	25		2,08	mWs					
		125		2,97						
		150		3,2						
Turn-off energy (per pulse)	E_{off}	25		1,51	mWs					
		125		2,28						
		150		2,56						



Vincotech

V23990-P767-A-PM
datasheet

Characteristic Values

Parameter	Symbol	Conditions					Values			Unit
		V_{GE} [V] V_{GS} [V]	V_{CE} [V] V_{DS} [V] V_F [V]	I_C [A] I_D [A] I_F [A]	T_j [°C]	Min	Typ	Max		
Brake Diode										
Static										
Forward voltage	V_F				25	25 125 150	1,35	1,93 1,94 1,92	2,05 ⁽¹⁾	V
Reverse leakage current	I_R	$V_r = 1200$ V				25			5,2	μA
Thermal										
Thermal resistance junction to sink ⁽²⁾	$R_{th(j-s)}$	$\lambda_{paste} = 3,4$ W/mK (PSX)						1,09		K/W
Dynamic										
Peak recovery current	I_{RRM}					25 125 150		13,47 17,18 18,1		A
Reverse recovery time	t_{rr}					25 125 150		292,72 443,48 474,27		ns
Recovered charge	Q_r	$di/dt=444$ A/μs $di/dt=432$ A/μs $di/dt=462$ A/μs	0/15	600	25	25 125 150		1,69 3,25 3,66		μC
Reverse recovered energy	E_{rec}					25 125 150		0,579 1,15 1,3		mWs
Peak rate of fall of recovery current	$(di_r/dt)_{max}$					25 125 150		51,57 46,4 43,42		A/μs



Characteristic Values

Parameter	Symbol	Conditions					Values			Unit
		V_{GS} [V]	V_{GE} [V]	V_{DS} [V]	V_{CE} [V]	T_j [°C]	Min	Typ	Max	

Brake Sw. Protection Diode

Static

Forward voltage	V_F				10	25 125 150	1,35	1,88 1,89 1,87	2,05 ⁽¹⁾	V
Reverse leakage current	I_R	$V_r = 1200$ V				25			2,7	μA

Thermal

Thermal resistance junction to sink ⁽²⁾	$R_{th(j-s)}$	$\lambda_{paste} = 3,4$ W/mK (PSX)						1,68		K/W
--	---------------	------------------------------------	--	--	--	--	--	------	--	-----

Rectifier Diode

Static

Forward voltage	V_F				25	25 125		0,987 0,901	1,21 ⁽¹⁾ 1,1 ⁽¹⁾	V
Reverse leakage current	I_R	$V_r = 1600$ V				25			50	μA

Thermal

Thermal resistance junction to sink ⁽²⁾	$R_{th(j-s)}$	$\lambda_{paste} = 3,4$ W/mK (PSX)						0,66		K/W
--	---------------	------------------------------------	--	--	--	--	--	------	--	-----



Characteristic Values

Parameter	Symbol	Conditions					Values			Unit
		V_{GE} [V] V_{GS} [V]	V_{CE} [V] V_{DS} [V] V_F [V]	I_C [A] I_D [A] I_F [A]	T_j [°C]	Min	Typ	Max		

Thermistor

Static

Rated resistance	R				25		22		kΩ
Deviation of R_{100}	$A_{R/R}$	$R_{100} = 1486 \Omega$			100	-12		14	%
Power dissipation	P						200		mW
Power dissipation constant	d				25		2		mW/K
B-value	$B_{(25/50)}$	Tol. $\pm 3 \%$					3950		K
B-value	$B_{(25/100)}$	Tol. $\pm 3 \%$					3998		K
Vincotech Thermistor Reference								B	

⁽¹⁾ Value at chip level

⁽²⁾ Only valid with pre-applied Vincotech thermal interface material.



Inverter Switch Characteristics

figure 1. IGBT

Typical output characteristics

$$I_C = f(V_{CE})$$

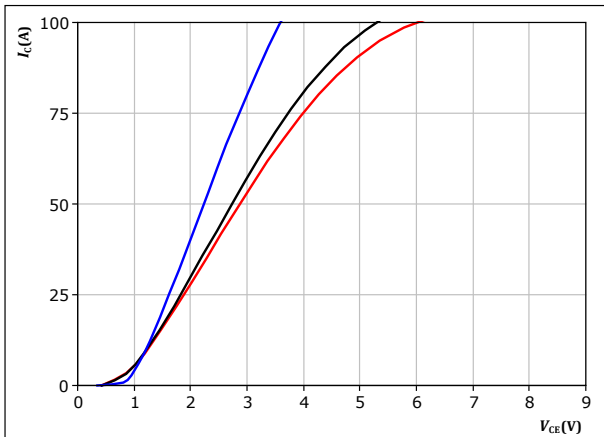

$t_p = 250 \mu s$
 $V_{GE} = 15 V$
 $T_j:$ 25 °C, 125 °C, 150 °C

figure 2. IGBT

Typical output characteristics

$$I_C = f(V_{CE})$$

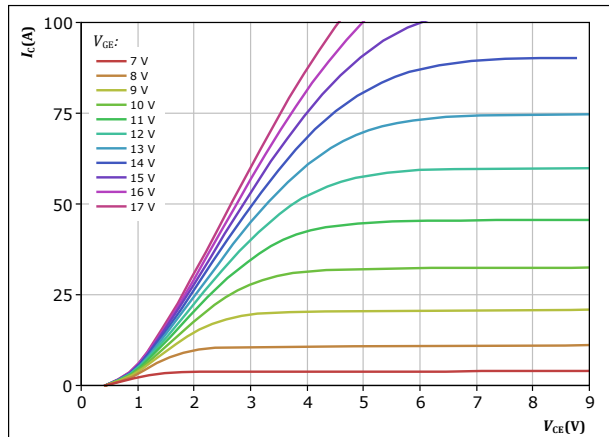

$t_p = 250 \mu s$
 $T_j = 150 \text{ °C}$
 V_{GE} from 7 V to 17 V in steps of 1 V

figure 3. IGBT

Typical transfer characteristics

$$I_C = f(V_{GE})$$

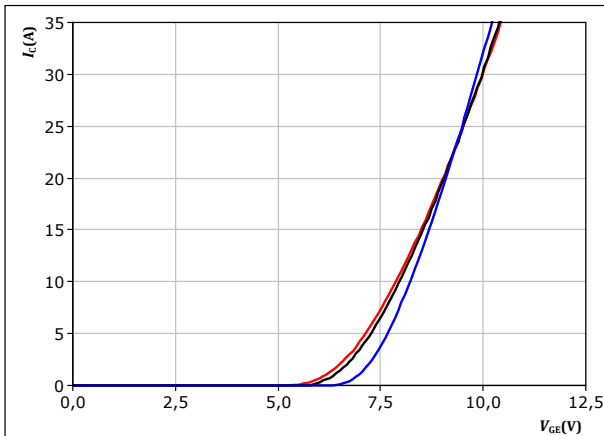

$t_p = 250 \mu s$
 $V_{CE} = 10 V$
 $T_j:$ 25 °C, 125 °C, 150 °C

figure 4. IGBT

Transient thermal impedance as a function of pulse width

$$Z_{th(j-s)} = f(t_p)$$

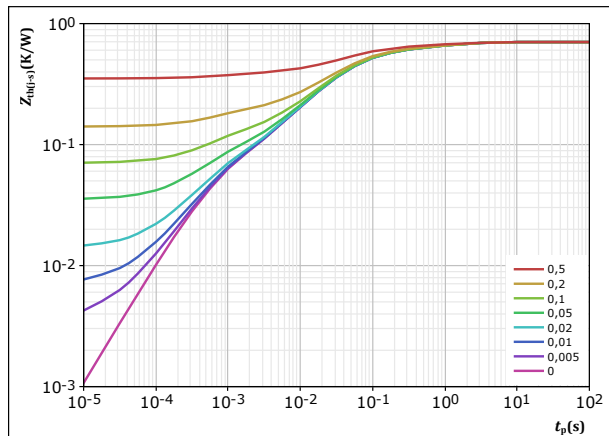

$D = t_p / T$
 $R_{th(j-s)} = 0,704 \text{ K/W}$
IGBT thermal model values

R (K/W)	τ (s)
8,05E-02	1,62E+00
1,47E-01	1,81E-01
3,23E-01	3,75E-02
9,88E-02	9,21E-03
5,47E-02	6,24E-04



Inverter Switch Characteristics

figure 5. IGBT

Safe operating area

$$I_C = f(V_{CE})$$

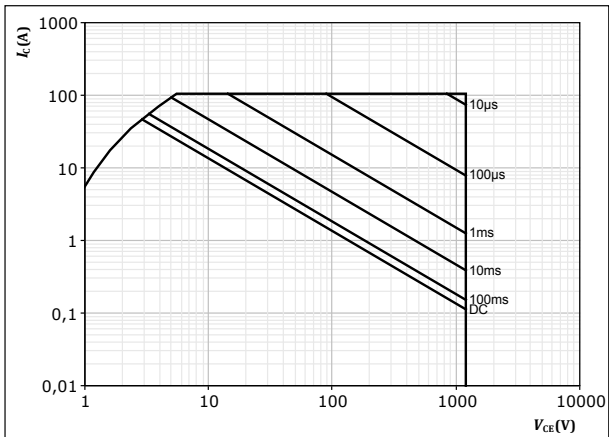

$D =$ single pulse
 $T_s = 80 \text{ } ^\circ\text{C}$
 $V_{CE} = 15 \text{ V}$
 $T_j = T_{jmax}$



Inverter Diode Characteristics

figure 6. FWD

Typical forward characteristics

$$I_F = f(V_F)$$

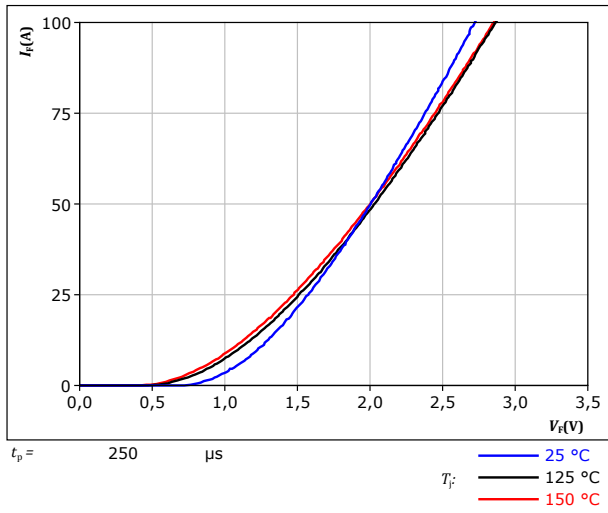
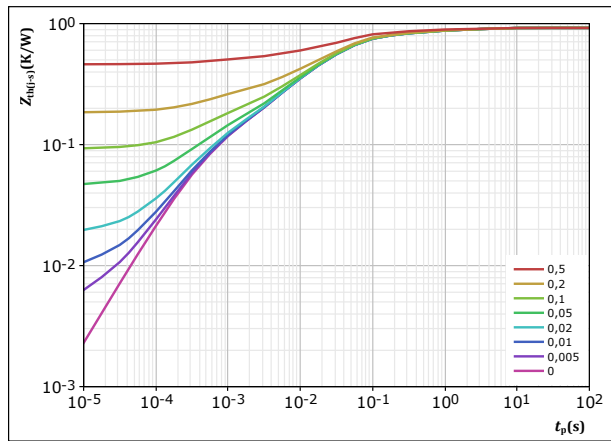

figure 7. FWD

Transient thermal impedance as a function of pulse width

$$Z_{th(j-s)} = f(t_p)$$



$D = \frac{t_p}{T}$
 $R_{th(j-s)} = 0,921 \text{ K/W}$
 FWD thermal model values

R (K/W)	τ (s)
6,37E-02	2,67E+00
1,36E-01	2,25E-01
4,78E-01	3,27E-02
1,59E-01	5,18E-03
8,43E-02	4,54E-04



Brake Switch Characteristics

figure 8. IGBT

Typical output characteristics

$$I_C = f(V_{CE})$$

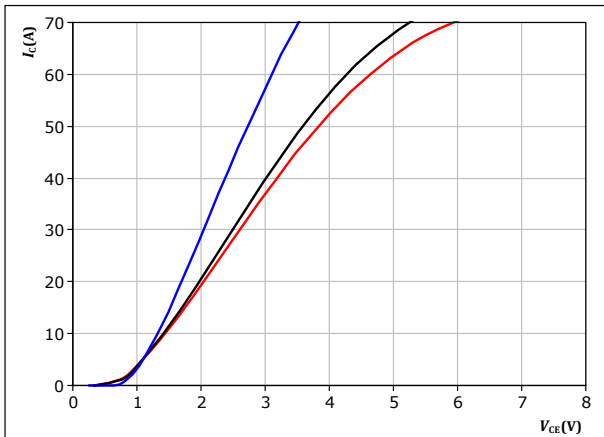

$t_p = 250 \mu s$
 $V_{GE} = 15 V$
 $T_j:$ — 25 °C
— 125 °C
— 150 °C

figure 9. IGBT

Typical output characteristics

$$I_C = f(V_{CE})$$

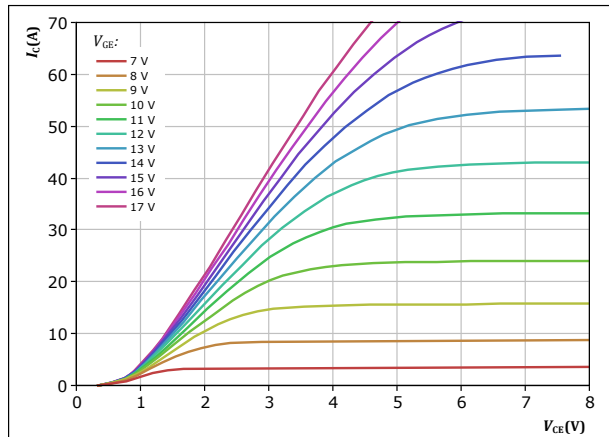

$t_p = 250 \mu s$
 $T_j = 150 \text{ °C}$
 V_{GE} from 7 V to 17 V in steps of 1 V

figure 10. IGBT

Typical transfer characteristics

$$I_C = f(V_{GE})$$

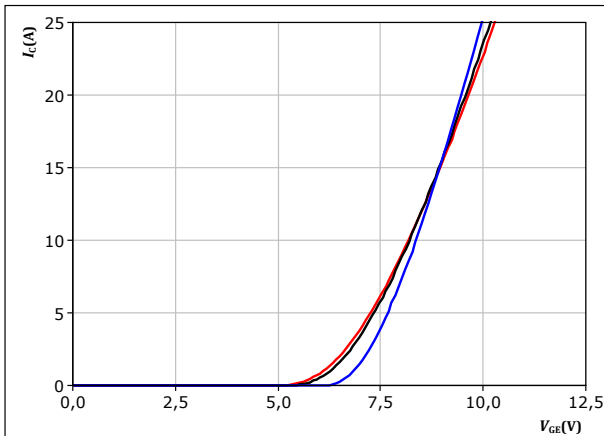

$t_p = 250 \mu s$
 $V_{CE} = 10 V$
 $T_j:$ — 25 °C
— 125 °C
— 150 °C

figure 11. IGBT

Transient thermal impedance as a function of pulse width

$$Z_{th(j-s)} = f(t_p)$$

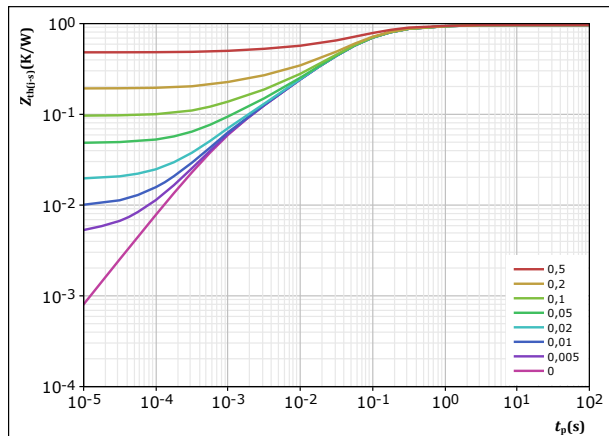

$D = t_p / T$
 $R_{th(j-s)} = 0,964 \text{ K/W}$
IGBT thermal model values

R (K/W)	τ (s)
9,34E-02	8,35E-01
3,42E-01	1,19E-01
3,61E-01	4,14E-02
1,15E-01	7,70E-03
5,33E-02	9,80E-04



Brake Switch Characteristics

figure 12. IGBT

Safe operating area

$$I_C = f(V_{CE})$$

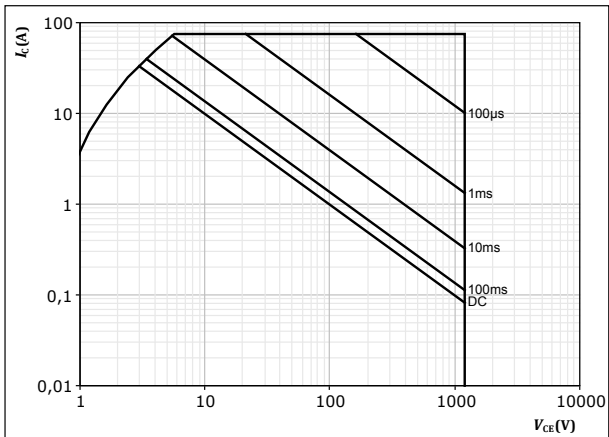

D = single pulse
T_s = 80 °C
V_{CE} = 15 V
T_j = T_{jmax}



Brake Diode Characteristics

figure 13. FWD

Typical forward characteristics

$$I_F = f(V_F)$$

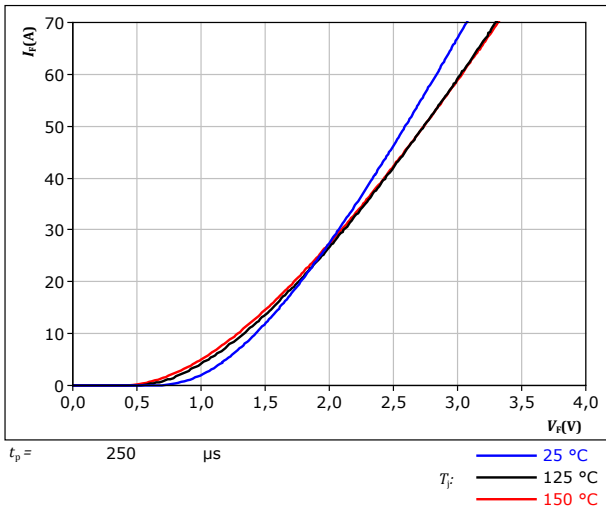
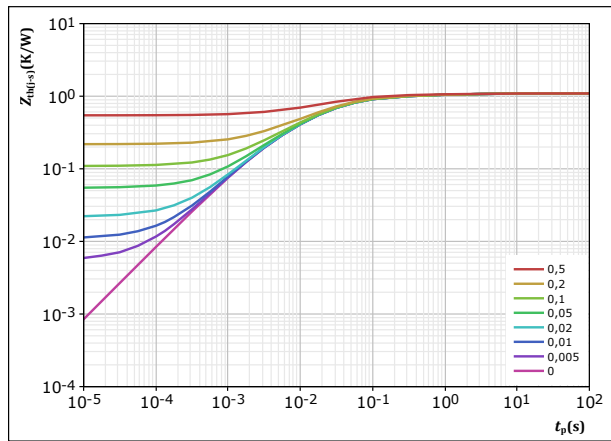

figure 14. FWD

Transient thermal impedance as a function of pulse width

$$Z_{th(j-s)} = f(t_p)$$



$D =$	t_p / T	
$R_{th(j-s)} =$	1,091	K/W
FWD thermal model values		
R (K/W)	τ (s)	
5,34E-02	2,93E+00	
9,71E-02	3,59E-01	
4,43E-01	4,79E-02	
3,93E-01	1,21E-02	
1,05E-01	2,46E-03	



Brake Sw. Protection Diode Characteristics

figure 15. FWD

Typical forward characteristics

$$I_F = f(V_F)$$

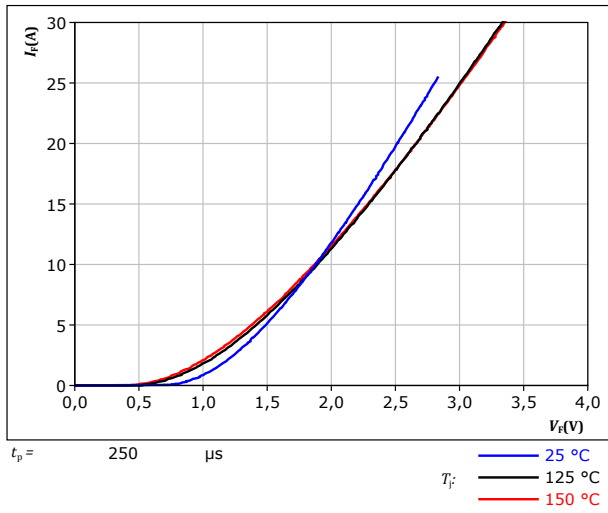
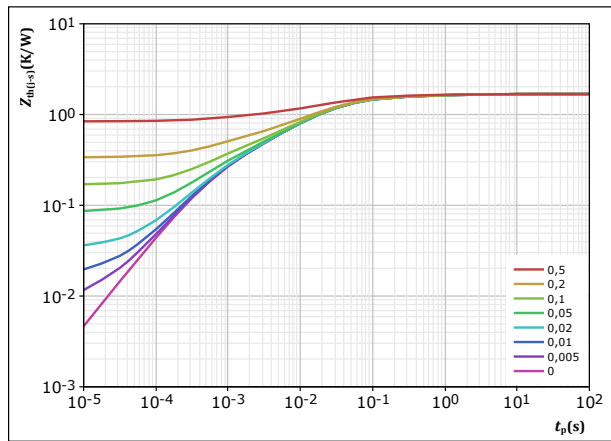

figure 16. FWD

Transient thermal impedance as a function of pulse width

$$Z_{th(j-s)} = f(t_p)$$



$D = t_p / T$
 $R_{th(j-s)} = 1,683 \text{ K/W}$
 FWD thermal model values

R (K/W)	τ (s)
6,27E-02	2,99E+00
1,53E-01	2,72E-01
5,57E-01	4,10E-02
4,90E-01	1,29E-02
2,45E-01	3,00E-03
1,75E-01	5,24E-04



Rectifier Diode Characteristics

figure 17. Rectifier

Typical forward characteristics

$$I_F = f(V_F)$$

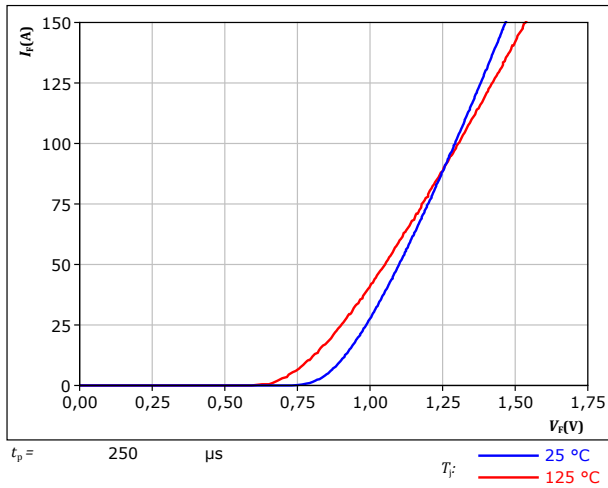
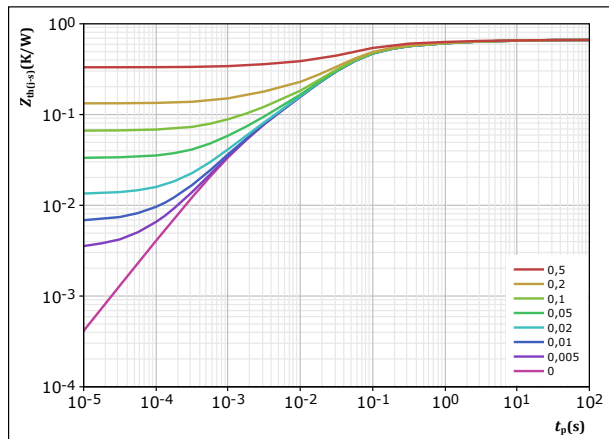

figure 18. Rectifier

Transient thermal impedance as a function of pulse width

$$Z_{th(j-s)} = f(t_p)$$



$D = t_p / T$

$R_{th(j-s)} = 0,664 \text{ K/W}$

Rectifier thermal model values

$R \text{ (K/W)}$	$\tau \text{ (s)}$
2,64E-02	1,18E+01
6,63E-02	1,18E+00
1,36E-01	1,65E-01
3,29E-01	4,29E-02
6,63E-02	1,04E-02
3,95E-02	1,49E-03



Thermistor Characteristics

figure 19. Thermistor

Typical NTC characteristic as function of temperature

$$R_T = f(T)$$

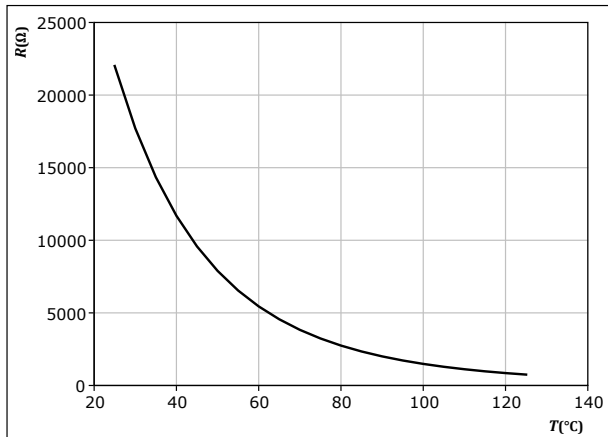



Inverter Switching Characteristics

figure 20. IGBT

Typical switching energy losses as a function of collector current
 $E = f(I_c)$

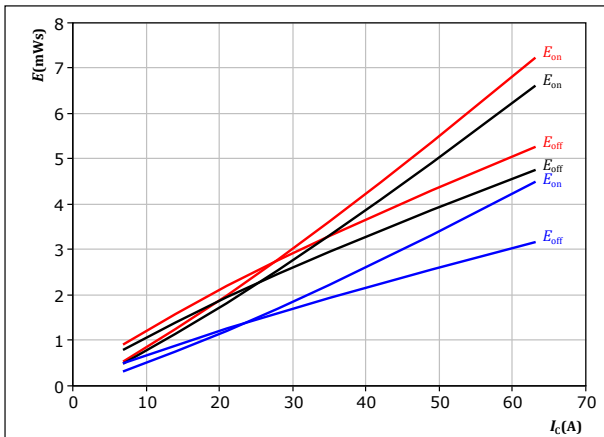

With an inductive load at
 $V_{CE} = 600 \text{ V}$
 $V_{GE} = \pm 15 \text{ V}$
 $R_{gon} = 16 \ \Omega$
 $R_{goff} = 16 \ \Omega$

T_j : — 25 °C
 — 125 °C
 — 150 °C

figure 21. IGBT

Typical switching energy losses as a function of gate resistor
 $E = f(R_g)$

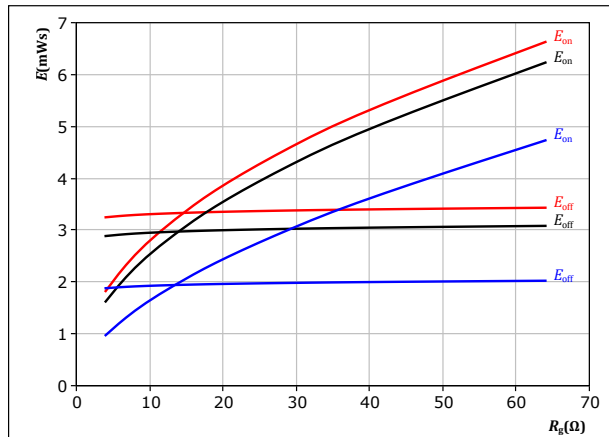

With an inductive load at
 $V_{CE} = 600 \text{ V}$
 $V_{GE} = \pm 15 \text{ V}$
 $I_c = 35 \text{ A}$

T_j : — 25 °C
 — 125 °C
 — 150 °C

figure 22. FWD

Typical reverse recovered energy loss as a function of collector current
 $E_{rec} = f(I_c)$

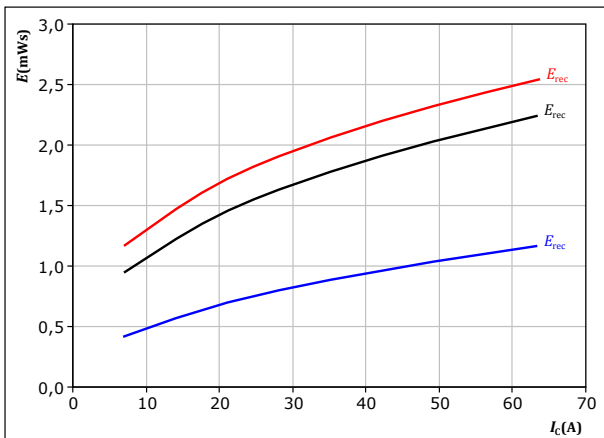

With an inductive load at
 $V_{CE} = 600 \text{ V}$
 $V_{GE} = \pm 15 \text{ V}$
 $R_{gon} = 16 \ \Omega$

T_j : — 25 °C
 — 125 °C
 — 150 °C

figure 23. FWD

Typical reverse recovered energy loss as a function of gate resistor
 $E_{rec} = f(R_g)$

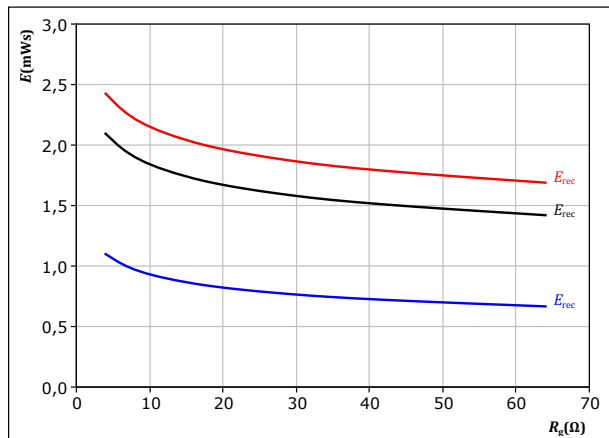

With an inductive load at
 $V_{CE} = 600 \text{ V}$
 $V_{GE} = \pm 15 \text{ V}$
 $I_c = 35 \text{ A}$

T_j : — 25 °C
 — 125 °C
 — 150 °C



Inverter Switching Characteristics

figure 24. IGBT

Typical switching times as a function of collector current
 $t = f(I_c)$

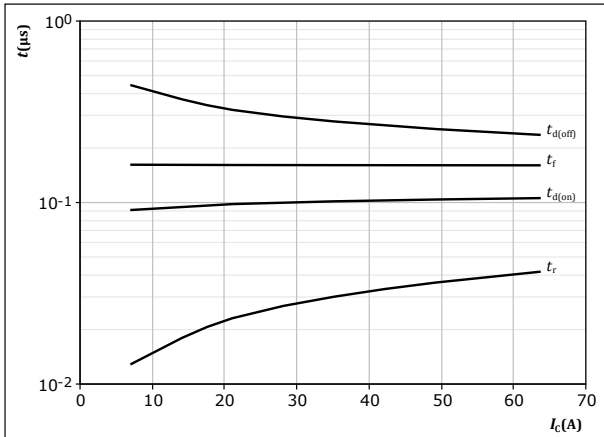

With an inductive load at
 $T_j = 150 \text{ }^\circ\text{C}$
 $V_{CE} = 600 \text{ V}$
 $V_{GE} = \pm 15 \text{ V}$
 $R_{g(on)} = 16 \text{ } \Omega$
 $R_{g(off)} = 16 \text{ } \Omega$

figure 25. IGBT

Typical switching times as a function of gate resistor
 $t = f(R_g)$

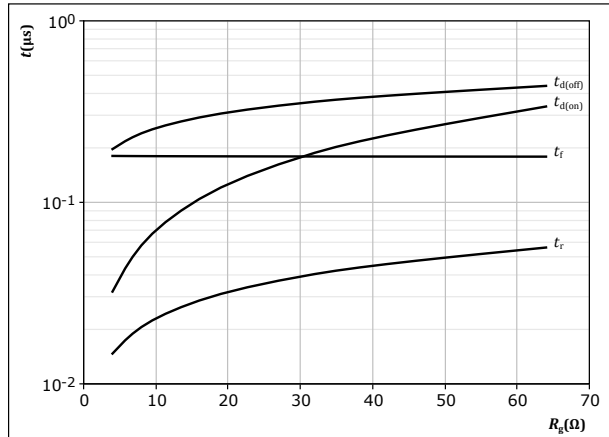

With an inductive load at
 $T_j = 150 \text{ }^\circ\text{C}$
 $V_{CE} = 600 \text{ V}$
 $V_{GE} = \pm 15 \text{ V}$
 $I_c = 35 \text{ A}$

figure 26. FWD

Typical reverse recovery time as a function of collector current
 $t_{rr} = f(I_c)$

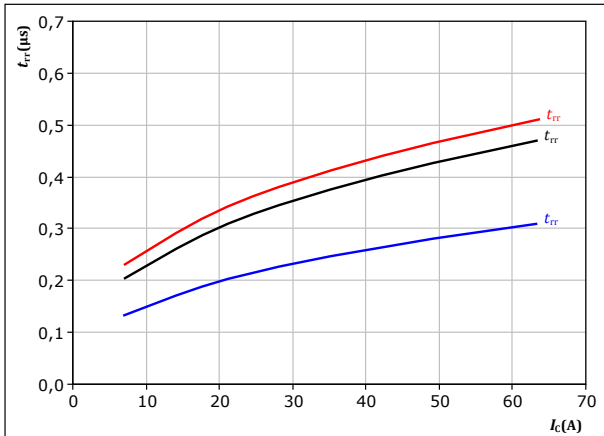

With an inductive load at
 $V_{CE} = 600 \text{ V}$
 $V_{GE} = \pm 15 \text{ V}$
 $R_{g(on)} = 16 \text{ } \Omega$
 $T_j:$ — 25 °C
 — 125 °C
 — 150 °C

figure 27. FWD

Typical reverse recovery time as a function of IGBT turn off gate resistor
 $t_{rr} = f(R_{g(off)})$

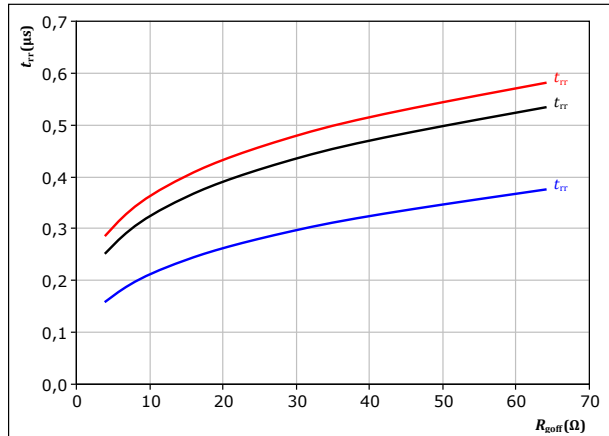

With an inductive load at
 $V_{CE} = 600 \text{ V}$
 $V_{GE} = \pm 15 \text{ V}$
 $I_c = 35 \text{ A}$
 $T_j:$ — 25 °C
 — 125 °C
 — 150 °C



Inverter Switching Characteristics

figure 28. FWD

Typical recovered charge as a function of collector current

$$Q_r = f(I_c)$$

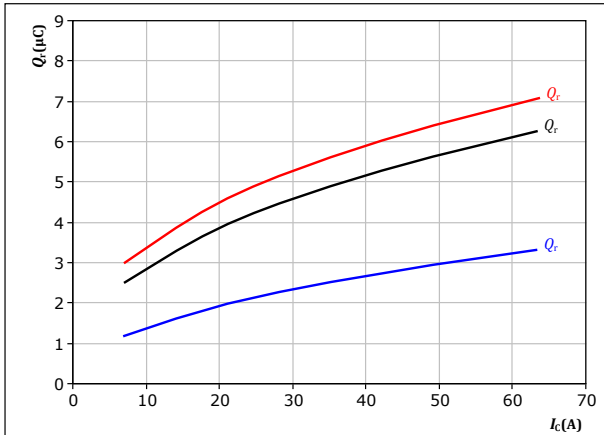

With an inductive load at

$V_{CE} = 600$ V
 $V_{GE} = \pm 15$ V
 $R_{goff} = 16$ Ω
 T_j : 25 °C (blue), 125 °C (black), 150 °C (red)

figure 29. FWD

Typical recovered charge as a function of turn off gate resistor

$$Q_r = f(R_{goff})$$

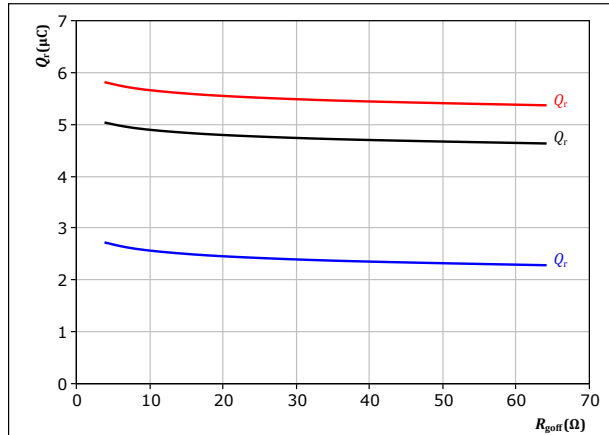

With an inductive load at

$V_{CE} = 600$ V
 $V_{GE} = \pm 15$ V
 $I_c = 35$ A
 T_j : 25 °C (blue), 125 °C (black), 150 °C (red)

figure 30. FWD

Typical peak reverse recovery current as a function of collector current

$$I_{RM} = f(I_c)$$

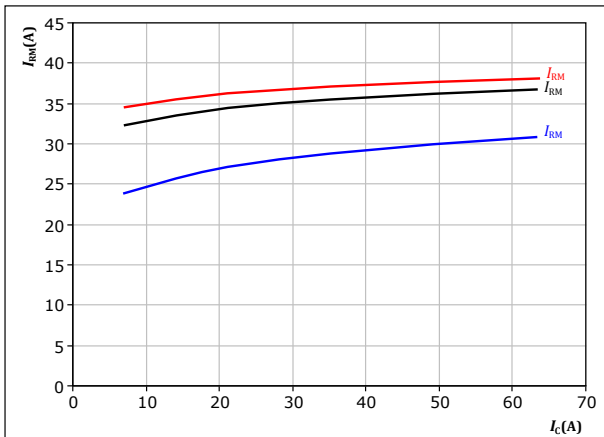

With an inductive load at

$V_{CE} = 600$ V
 $V_{GE} = \pm 15$ V
 $R_{goff} = 16$ Ω
 T_j : 25 °C (blue), 125 °C (black), 150 °C (red)

figure 31. FWD

Typical peak reverse recovery current as a function of turn off gate resistor

$$I_{RM} = f(R_{goff})$$

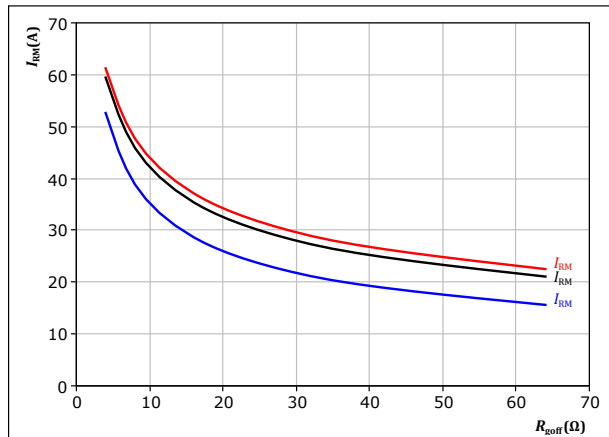

With an inductive load at

$V_{CE} = 600$ V
 $V_{GE} = \pm 15$ V
 $I_c = 35$ A
 T_j : 25 °C (blue), 125 °C (black), 150 °C (red)



Inverter Switching Characteristics

figure 32. FWD

Typical rate of fall of forward and reverse recovery current as a function of collector current
 $di_f/dt, di_{rr}/dt = f(I_c)$

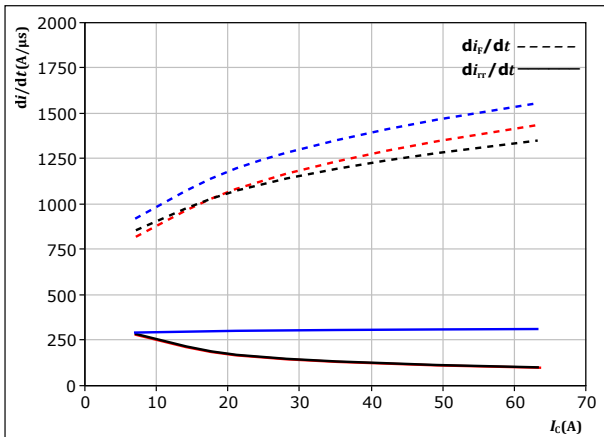

With an inductive load at

$V_{CE} = 600$ V	$T_j = 25$ °C
$V_{GE} = \pm 15$ V	$T_j = 125$ °C
$R_{goff} = 16$ Ω	$T_j = 150$ °C

figure 33. FWD

Typical rate of fall of forward and reverse recovery current as a function of turn off gate resistor
 $di_f/dt, di_{rr}/dt = f(R_{goff})$

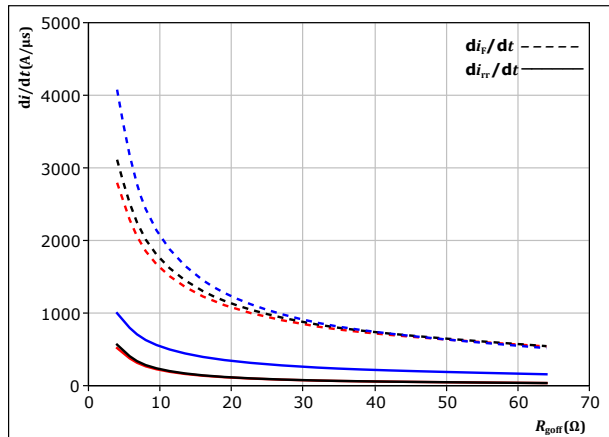

With an inductive load at

$V_{CE} = 600$ V	$T_j = 25$ °C
$V_{GE} = \pm 15$ V	$T_j = 125$ °C
$I_c = 35$ A	$T_j = 150$ °C

figure 34. IGBT

Reverse bias safe operating area
 $I_c = f(V_{CE})$

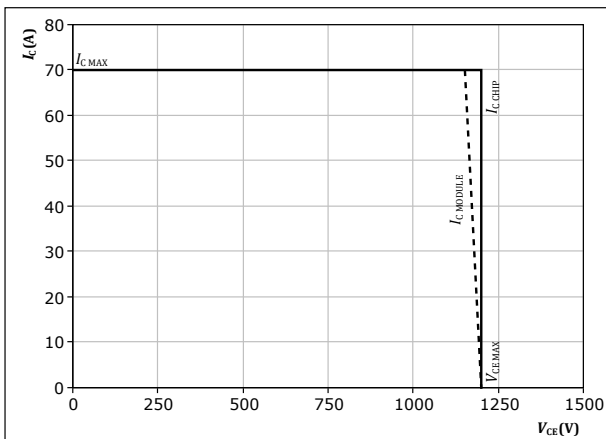

At $T_j = 150$ °C
 $R_{goff} = 16$ Ω
 $R_{goff} = 16$ Ω



Brake Switching Characteristics

figure 35. IGBT

Typical switching energy losses as a function of collector current
 $E = f(I_c)$

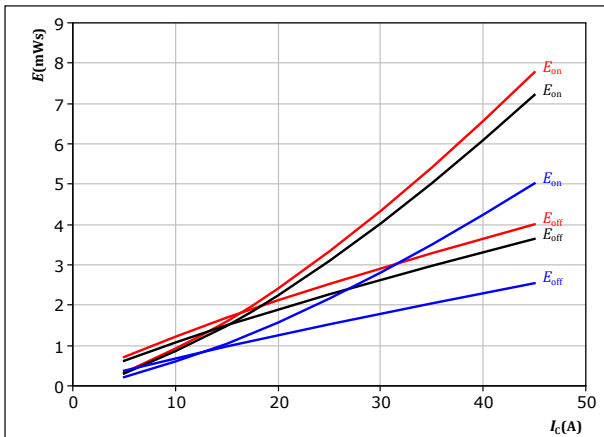

With an inductive load at
 $V_{CE} = 600 \text{ V}$
 $V_{GE} = 0/15 \text{ V}$
 $R_{gon} = 32 \ \Omega$
 $R_{goff} = 32 \ \Omega$

T_j : — 25 °C
 — 125 °C
 — 150 °C

figure 36. IGBT

Typical switching energy losses as a function of gate resistor
 $E = f(R_g)$

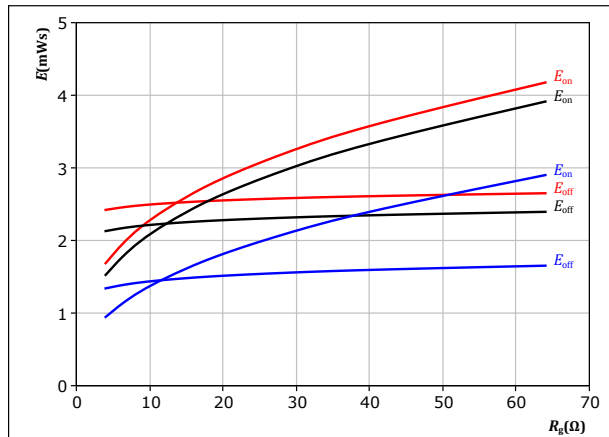

With an inductive load at
 $V_{CE} = 600 \text{ V}$
 $V_{GE} = 0/15 \text{ V}$
 $I_c = 25 \text{ A}$

T_j : — 25 °C
 — 125 °C
 — 150 °C

figure 37. FWD

Typical reverse recovered energy loss as a function of collector current
 $E_{rec} = f(I_c)$

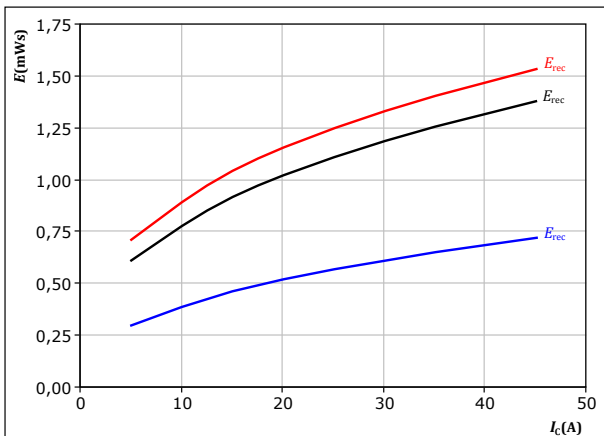

With an inductive load at
 $V_{CE} = 600 \text{ V}$
 $V_{GE} = 0/15 \text{ V}$
 $R_{gon} = 32 \ \Omega$

T_j : — 25 °C
 — 125 °C
 — 150 °C

figure 38. FWD

Typical reverse recovered energy loss as a function of gate resistor
 $E_{rec} = f(R_g)$

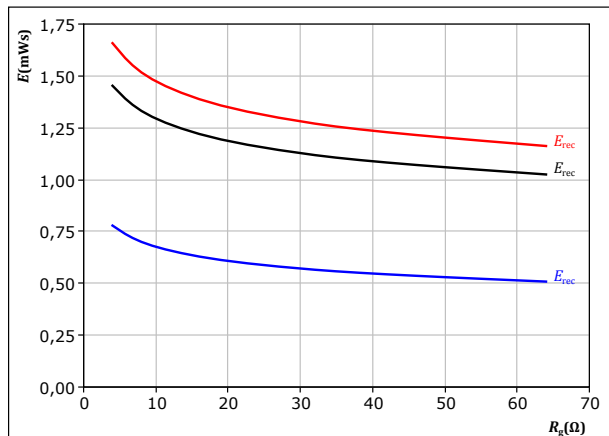

With an inductive load at
 $V_{CE} = 600 \text{ V}$
 $V_{GE} = 0/15 \text{ V}$
 $I_c = 25 \text{ A}$

T_j : — 25 °C
 — 125 °C
 — 150 °C



Brake Switching Characteristics

figure 39. IGBT

Typical switching times as a function of collector current
 $t = f(I_c)$

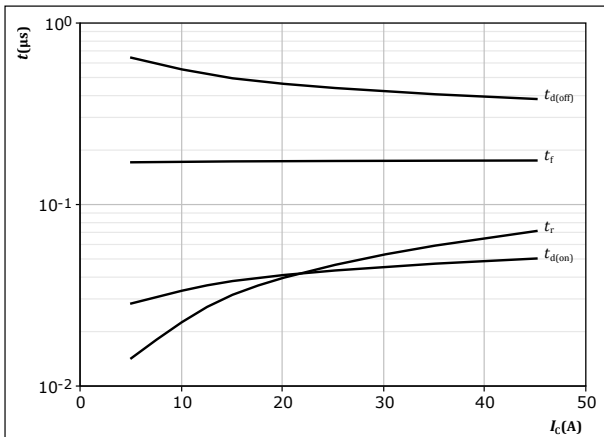

With an inductive load at
 $T_j = 150 \text{ }^\circ\text{C}$
 $V_{CE} = 600 \text{ V}$
 $V_{GE} = 0/15 \text{ V}$
 $R_{g(on)} = 32 \text{ } \Omega$
 $R_{g(off)} = 32 \text{ } \Omega$

figure 40. IGBT

Typical switching times as a function of gate resistor
 $t = f(R_g)$

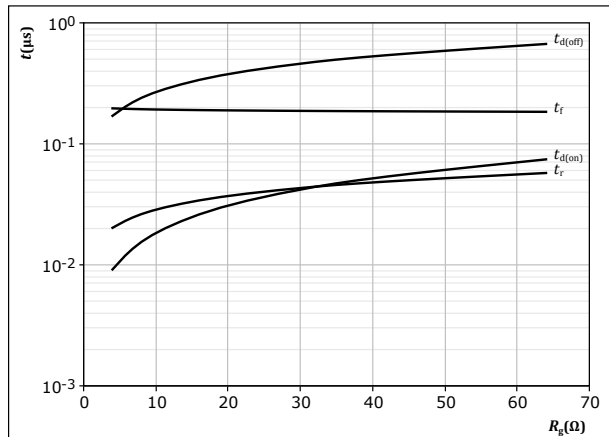

With an inductive load at
 $T_j = 150 \text{ }^\circ\text{C}$
 $V_{CE} = 600 \text{ V}$
 $V_{GE} = 0/15 \text{ V}$
 $I_c = 25 \text{ A}$

figure 41. FWD

Typical reverse recovery time as a function of collector current
 $t_{rr} = f(I_c)$

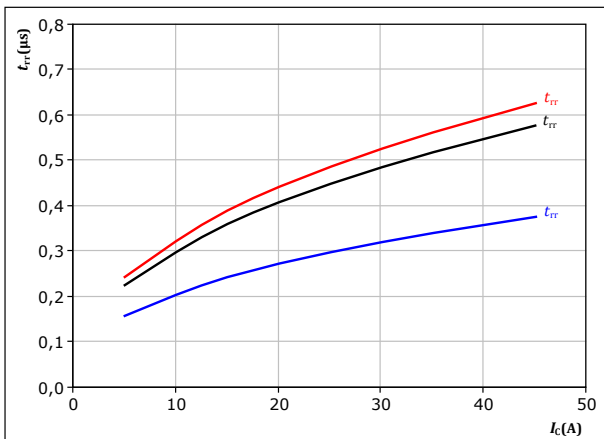

With an inductive load at
 $V_{CE} = 600 \text{ V}$
 $V_{GE} = 0/15 \text{ V}$
 $R_{g(on)} = 32 \text{ } \Omega$
 $T_j:$ — 25 $^\circ\text{C}$
 — 125 $^\circ\text{C}$
 — 150 $^\circ\text{C}$

figure 42. FWD

Typical reverse recovery time as a function of IGBT turn off gate resistor
 $t_{rr} = f(R_{g(off)})$

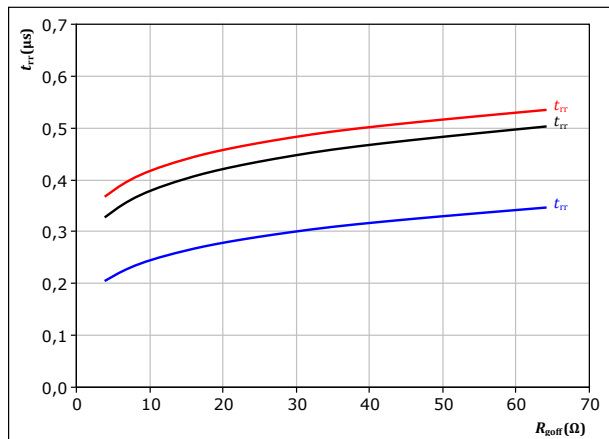

With an inductive load at
 $V_{CE} = 600 \text{ V}$
 $V_{GE} = 0/15 \text{ V}$
 $I_c = 25 \text{ A}$
 $T_j:$ — 25 $^\circ\text{C}$
 — 125 $^\circ\text{C}$
 — 150 $^\circ\text{C}$



Brake Switching Characteristics

figure 43. FWD

Typical recovered charge as a function of collector current

$$Q_r = f(I_c)$$

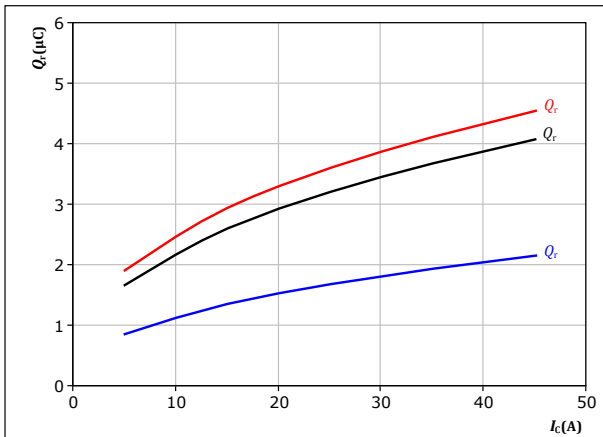

With an inductive load at

$V_{CE} = 600$ V
 $V_{GE} = 0/15$ V
 $R_{goff} = 32$ Ω

T_j :
— 25 °C
— 125 °C
— 150 °C

figure 44. FWD

Typical recovered charge as a function of turn off gate resistor

$$Q_r = f(R_{goff})$$

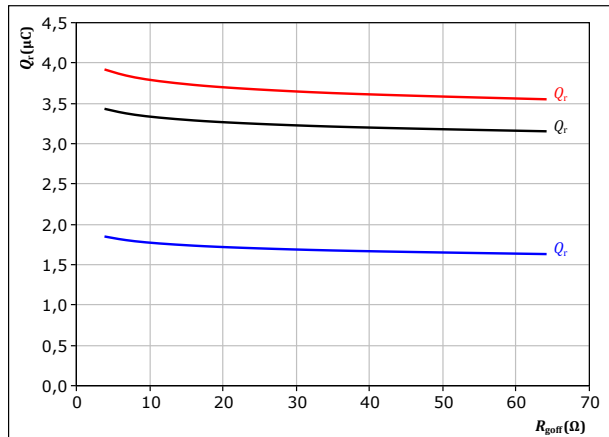

With an inductive load at

$V_{CE} = 600$ V
 $V_{GE} = 0/15$ V
 $I_c = 25$ A

T_j :
— 25 °C
— 125 °C
— 150 °C

figure 45. FWD

Typical peak reverse recovery current as a function of collector current

$$I_{RM} = f(I_c)$$

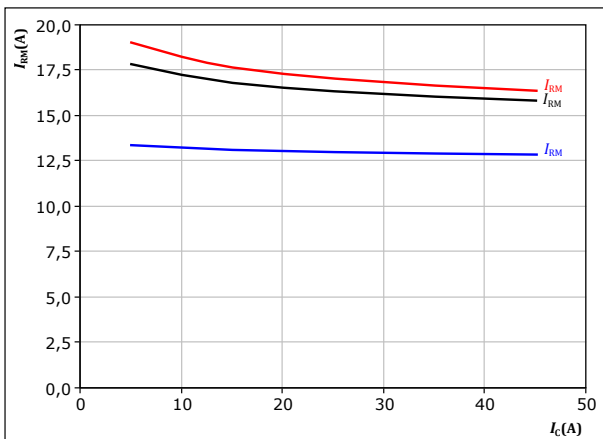

With an inductive load at

$V_{CE} = 600$ V
 $V_{GE} = 0/15$ V
 $R_{goff} = 32$ Ω

T_j :
— 25 °C
— 125 °C
— 150 °C

figure 46. FWD

Typical peak reverse recovery current as a function of turn off gate resistor

$$I_{RM} = f(R_{goff})$$

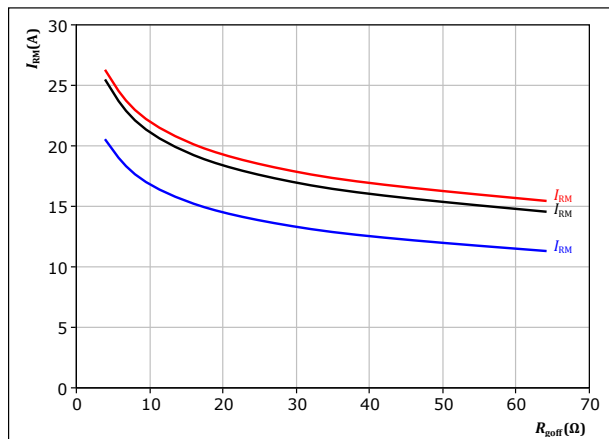

With an inductive load at

$V_{CE} = 600$ V
 $V_{GE} = 0/15$ V
 $I_c = 25$ A

T_j :
— 25 °C
— 125 °C
— 150 °C



Brake Switching Characteristics

figure 47. FWD

Typical rate of fall of forward and reverse recovery current as a function of collector current
 $di_f/dt, di_r/dt = f(I_C)$

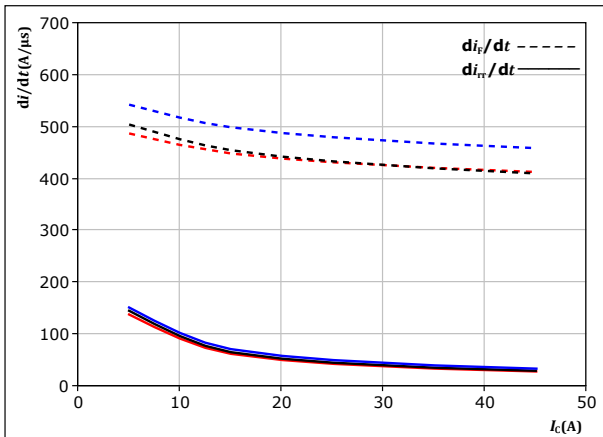

With an inductive load at

$V_{CE} =$	600	V	$T_j:$	25 °C
$V_{GE} =$	0/15	V		125 °C
$R_{goff} =$	32	Ω		150 °C

figure 48. FWD

Typical rate of fall of forward and reverse recovery current as a function of turn off gate resistor
 $di_f/dt, di_r/dt = f(R_{goff})$

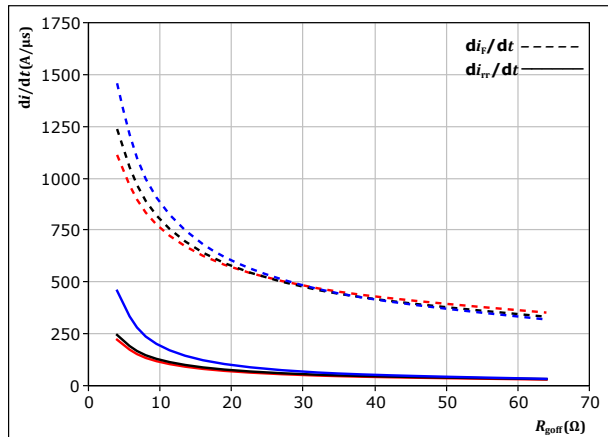

With an inductive load at

$V_{CE} =$	600	V	$T_j:$	25 °C
$V_{GE} =$	0/15	V		125 °C
$I_C =$	25	A		150 °C

figure 49. IGBT

Reverse bias safe operating area
 $I_C = f(V_{CE})$

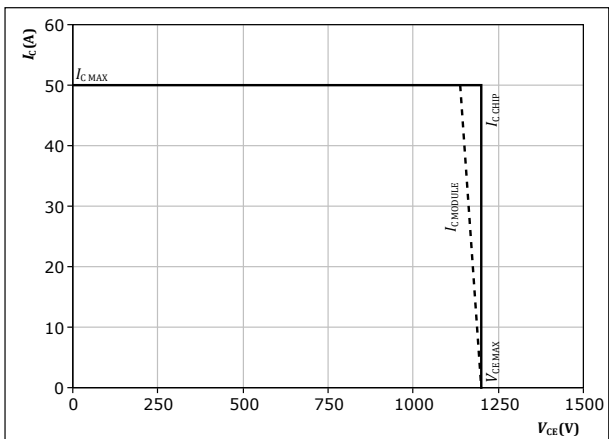

At $T_j = 150$ °C
 $R_{goff} = 32$ Ω
 $R_{gson} = 32$ Ω



Switching Definitions

figure 50. IGBT
Turn-off Switching Waveforms & definition of t_{doff} , t_{Eoff} (t_{Eoff} = integrating time for E_{off})

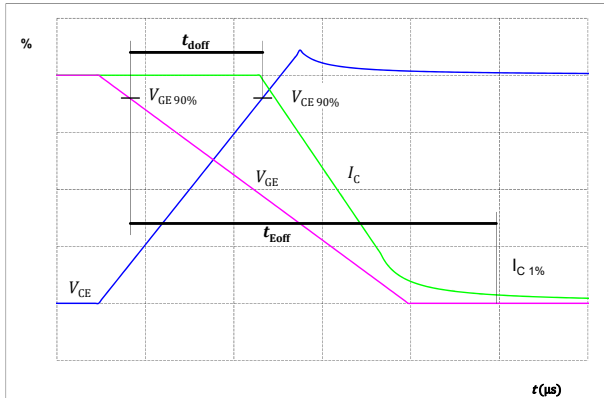

figure 51. IGBT
Turn-on Switching Waveforms & definition of t_{don} , t_{Eon} (t_{Eon} = integrating time for E_{on})

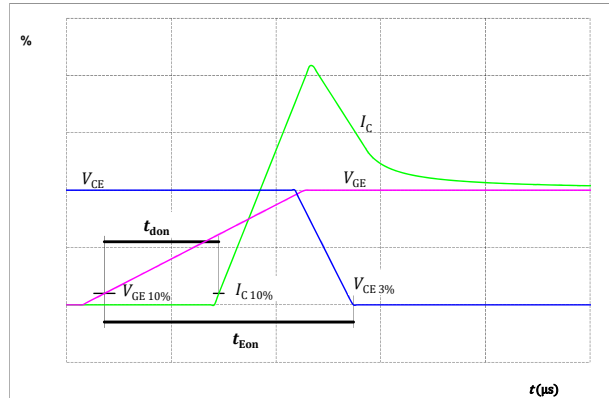

figure 52. IGBT
Turn-off Switching Waveforms & definition of t_f

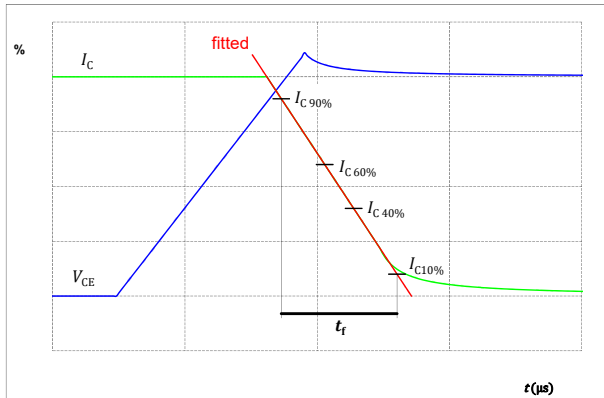
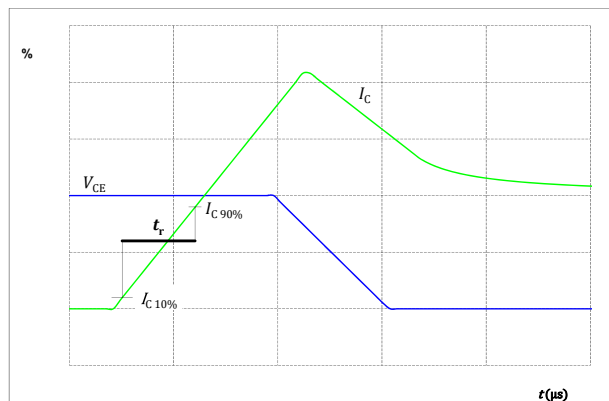

figure 53. IGBT
Turn-on Switching Waveforms & definition of t_r





Switching Definitions

figure 54. FWD

Turn-off Switching Waveforms & definition of t_{rr}

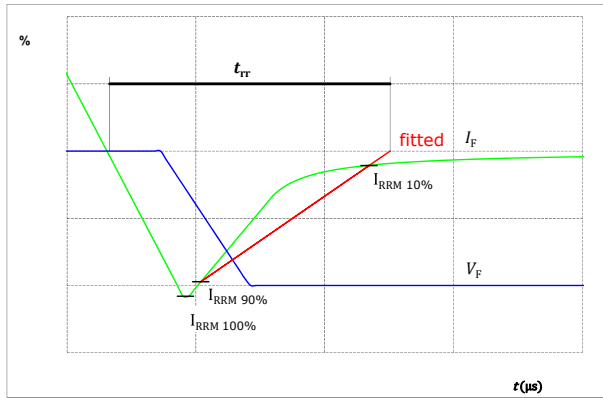
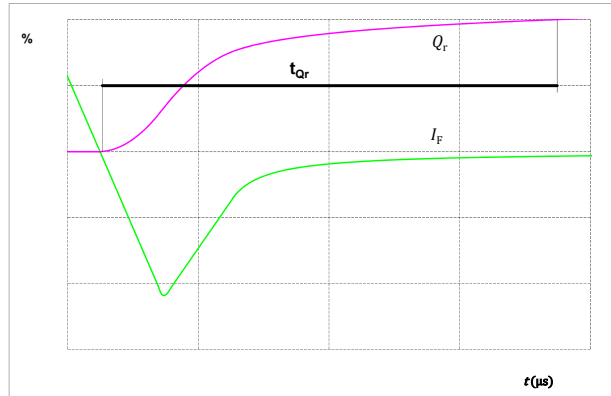

figure 55. FWD

Turn-on Switching Waveforms & definition of t_{Qr} (t_{Qr} = integrating time for Q_r)





Vincotech

V23990-P767-A-PM
datasheet

Ordering Code	
Version	Ordering Code
Without thermal paste	V23990-P767-A-PM
With thermal paste (3,4 W/mK, PSX-P7)	V23990-P767-A-/3/-PM

Marking							
	Text	VIN	Date code	Type&Ver	UL	Lot	Serial
		VIN	WWYY	TTTTTTV	UL	LLLL	SSSS
	Datamatrix	Type&Ver	Lot number	Serial	Date code		
		TTTTTTV	LLLL	SSSS	WWYY		

Outline							
Pin table [mm]							
Pin	X	Y	Function	29	0	37,2	U
1	71,2	0	DC-	30	2,5	37,2	U
2	68,7	0	DC-	31	5	37,2	U
3	66,2	0	DC-	32	7,8	37,2	E
4	63,7	0	DC-	33	10,6	37,2	G
5	55,95	0	DC+	34	18,45	37,2	G
6	53,45	0	DC+	35	21,25	37,2	E
7	55,95	2,8	DC+	36	24,05	37,2	V
8	53,45	2,8	DC+	37	26,55	37,2	V
9	48,4	0	DC+	38	29,05	37,2	V
10	45,9	0	DC+	39	36,1	37,2	W
11	38,9	0	E	40	38,6	37,2	W
12	36,1	0	DC-	41	41,1	37,2	W
13	38,9	2,8	G	42	43,9	37,2	E
14	36,1	2,8	DC-	43	46,7	37,2	G
15	31,3	0	DC-	44	53,7	37,2	L1
16	28,5	0	E	45	56,2	37,2	L1
17	31,3	2,8	DC-	46	58,7	37,2	L1
18	28,5	2,8	G	47	71,2	37,2	L2
19	19,3	0	R2	48	71,2	34,7	L2
20	19,3	2,8	R1	49	71,2	32,2	L2
21	12,3	0	DC+	50	71,2	25,2	L3
22	9,8	0	DC+	51	71,2	22,7	L3
23	12,3	2,8	DC+	52	71,2	20,2	L3
24	9,8	2,8	DC+	53	68,7	12,8	BrC
25	2,8	0	E	54	71,2	12,8	BrC
26	0	0	DC-	55	71,2	5,6	BrG
27	2,8	2,8	G	56	71,2	2,8	BrE
28	0	2,8	DC-				

Technical drawing showing side and top views of the component. Dimensions include pin pitch (0.505), pin height (21.05), and various mounting hole diameters and positions.

Technical drawing showing top view of the component with pin locations marked. Dimensions include pin pitch (0.505), pin height (21.05), and various mounting hole diameters and positions.

Technical drawing showing top view of the component with pin locations marked. Dimensions include pin pitch (0.505), pin height (21.05), and various mounting hole diameters and positions.

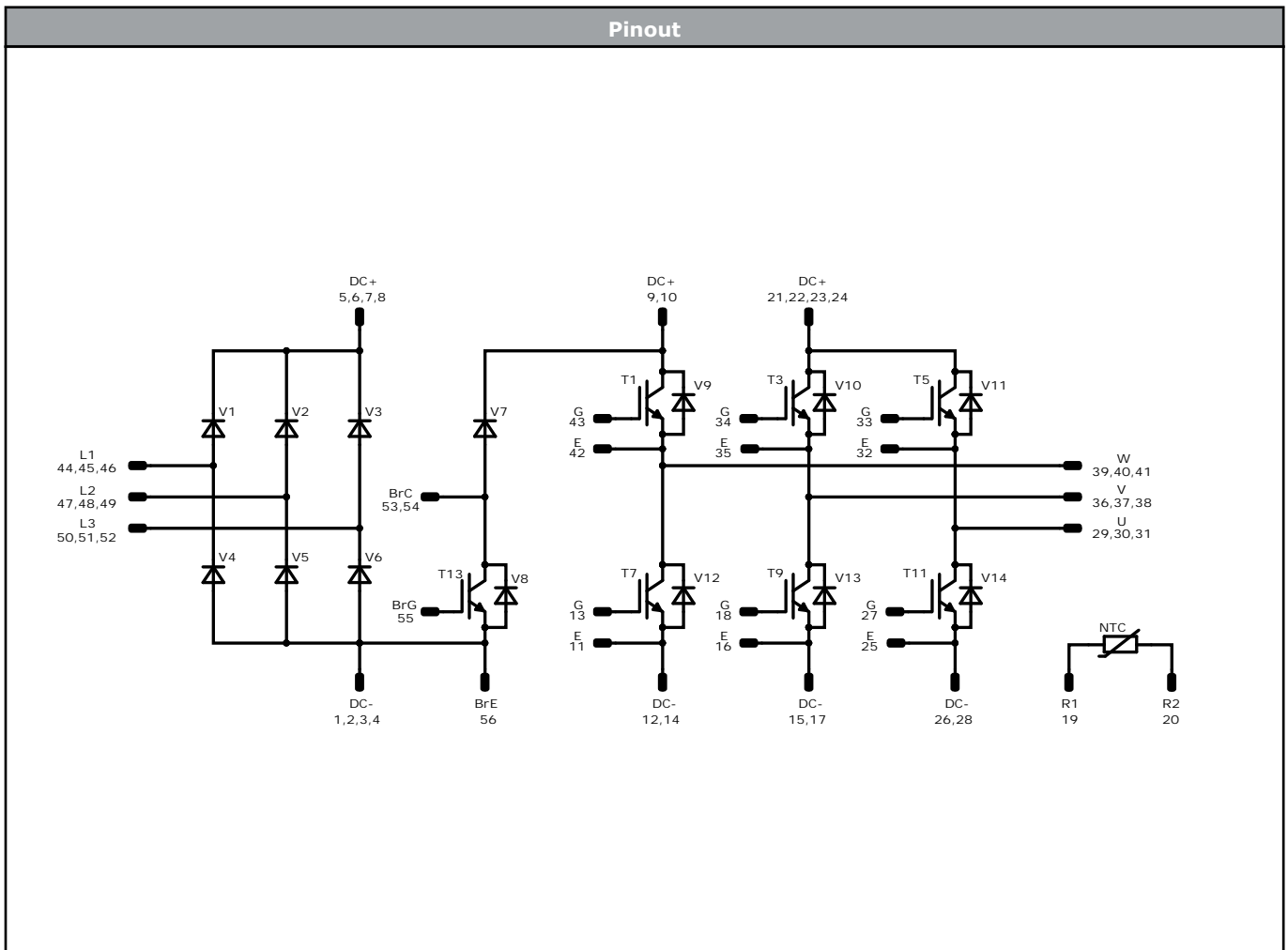

Identification					
ID	Component	Voltage	Current	Function	Comment
T7, T1, T9, T3, T11, T5	IGBT	1200 V	35 A	Inverter Switch	
V9, V12, V10, V13, V11, V14	FWD	1200 V	35 A	Inverter Diode	
T13	IGBT	1200 V	25 A	Brake Switch	
V7	FWD	1200 V	25 A	Brake Diode	
V8	FWD	1200 V	10 A	Brake Sw. Protection Diode	
V4, V1, V5, V2, V6, V3	Rectifier	1600 V	50 A	Rectifier Diode	
NTC	Thermistor			Thermistor	



Packaging instruction				
Standard packaging quantity (SPQ) 36	>SPQ	Standard	<SPQ	Sample

Handling instruction
Handling instructions for <i>flow 2</i> packages see vincotech.com website.

Package data
Package data for <i>flow 2</i> packages see vincotech.com website.

Vincotech thermistor reference
See Vincotech thermistor reference table at vincotech.com website.

UL recognition and file number
This device is certified according to UL 1557 standard, UL file number E192116. For more information see vincotech.com website. 

Document No.:	Date:	Modification:	Pages
V23990-P767-A-PM-D8-14	8 Sep. 2021	Rectifier maximum ratings corrected Isolation test voltage updated Clearance value corrected Rectifier static characteristics updated The thermal characteristics of brake switch, brake diode and brake switch protection diode updated Dynamic characteristics of inverter and brake are updated Thermistor vales updated New datasheet format, module is unchanged	

DISCLAIMER

The information, specifications, procedures, methods and recommendations herein (together "information") are presented by Vincotech to reader in good faith, are believed to be accurate and reliable, but may well be incomplete and/or not applicable to all conditions or situations that may exist or occur. Vincotech reserves the right to make any changes without further notice to any products to improve reliability, function or design. No representation, guarantee or warranty is made to reader as to the accuracy, reliability or completeness of said information or that the application or use of any of the same will avoid hazards, accidents, losses, damages or injury of any kind to persons or property or that the same will not infringe third parties rights or give desired results. It is reader's sole responsibility to test and determine the suitability of the information and the product for reader's intended use.

LIFE SUPPORT POLICY

Vincotech products are not authorised for use as critical components in life support devices or systems without the express written approval of Vincotech.

As used herein:

1. Life support devices or systems are devices or systems which, (a) are intended for surgical implant into the body, or (b) support or sustain life, or (c) whose failure to perform when properly used in accordance with instructions for use provided in labelling can be reasonably expected to result in significant injury to the user.
2. A critical component is any component of a life support device or system whose failure to perform can be reasonably expected to cause the failure of the life support device or system, or to affect its safety or effectiveness.

单击下面可查看定价，库存，交付和生命周期等信息

[>>Vincotech\(威科\)](#)