



flowPIM 0 + PFC

600 V / 30 A

Features

- PIM with integrated PFC
- High switching frequency PFC circuit
- On-board capacitor
- New generation high speed IGBTs in the inverter
- Shunt resistor in the input stage
- Integrated NTC

Target applications

- Embedded Drives
- Industrial Drives

Types

- 10-FZ06PPA030SJ-LS54E08

flow 0 12 mm housing



Schematic

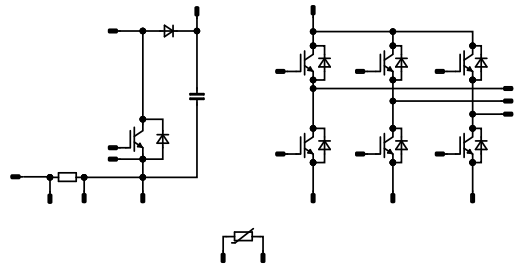



Vincotech

10-FZ06PPA030SJ-LS54E08
datasheet

Maximum Ratings

$T_j = 25\text{ °C}$, unless otherwise specified

Parameter	Symbol	Conditions	Value	Unit
Inverter Switch				
Collector-emitter voltage	V_{CES}		600	V
Collector current	I_C	$T_j = T_{jmax}$ $T_s = 80\text{ °C}$	29	A
Repetitive peak collector current	I_{CRM}	t_p limited by T_{jmax}	90	A
Total power dissipation	P_{tot}	$T_j = T_{jmax}$ $T_s = 80\text{ °C}$	58	W
Gate-emitter voltage	V_{GES}		± 20	V
Short circuit ratings	t_{SC}	$V_{GE} = 15\text{ V}$, $V_{CC} = 400\text{ V}$ $T_j = 150\text{ °C}$	5	μs
Maximum junction temperature	T_{jmax}		175	$^{\circ}\text{C}$

Inverter Diode

Peak repetitive reverse voltage	V_{RRM}		600	V
Continuous (direct) forward current	I_F	$T_j = T_{jmax}$ $T_s = 80\text{ °C}$	23	A
Repetitive peak forward current	I_{FRM}	t_p limited by T_{jmax}	40	A
Total power dissipation	P_{tot}	$T_j = T_{jmax}$ $T_s = 80\text{ °C}$	37	W
Maximum junction temperature	T_{jmax}		175	$^{\circ}\text{C}$

PFC Switch

Collector-emitter voltage	V_{CES}		650	V
Collector current	I_C	$T_j = T_{jmax}$ $T_s = 80\text{ °C}$	41	A
Repetitive peak collector current	I_{CRM}	t_p limited by T_{jmax}	150	A
Total power dissipation	P_{tot}	$T_j = T_{jmax}$ $T_s = 80\text{ °C}$	78	W
Gate-emitter voltage	V_{GES}		± 20	V
Maximum junction temperature	T_{jmax}		175	$^{\circ}\text{C}$



Vincotech

10-FZ06PPA030SJ-LS54E08
datasheet

Maximum Ratings

$T_j = 25\text{ °C}$, unless otherwise specified

Parameter	Symbol	Conditions	Value	Unit
PFC Diode				
Peak repetitive reverse voltage	V_{RRM}		650	V
Continuous (direct) forward current	I_F	$T_j = T_{jmax}$ $T_s = 80\text{ °C}$	62	A
Total power dissipation	P_{tot}	$T_j = T_{jmax}$ $T_s = 80\text{ °C}$	86	W
Maximum junction temperature	T_{jmax}		175	°C

PFC Sw. Protection Diode

Peak repetitive reverse voltage	V_{RRM}		650	V
Continuous (direct) forward current	I_F	$T_j = T_{jmax}$ $T_s = 80\text{ °C}$	8	A
Repetitive peak forward current	I_{FRM}	i_p limited by T_{jmax}	12	A
Total power dissipation	P_{tot}	$T_j = T_{jmax}$ $T_s = 80\text{ °C}$	36	W
Maximum junction temperature	T_{jmax}		175	°C

Shunt

DC current	I	$T_c = 70\text{ °C}$	31	A
Power dissipation	P_{tot}	$T_c = 70\text{ °C}$	4	W
Operation Temperature	T_{op}		-65 ... 170	°C

Capacitor (PFC)

Maximum DC voltage	V_{MAX}		630	V
Operation Temperature	T_{op}		-55 ... 150	°C



Vincotech

10-FZ06PPA030SJ-LS54E08
datasheet

Maximum Ratings

$T_j = 25\text{ °C}$, unless otherwise specified

Parameter	Symbol	Conditions	Value	Unit
-----------	--------	------------	-------	------

Module Properties

Thermal Properties

Storage temperature	T_{stg}		-40...+125	°C
Operation temperature under switching condition	T_{jop}		-40...+($T_{jmax} - 25$)	°C

Isolation Properties

Isolation voltage	V_{isol}	DC Test Voltage* $t_p = 2\text{ s}$	6000	V
Isolation voltage	V_{isol}	AC Voltage $t_p = 1\text{ min}$	2500	V
Creepage distance			min. 12,7	mm
Clearance			8,63	mm
Comparative Tracking Index	CTI		≥ 200	

*100 % tested in production



Vincotech

Characteristic Values

Parameter	Symbol	Conditions					Values			Unit
		V_{GS} [V]	V_{GE} [V]	V_{DS} [V]	I_D [A]	T_j [°C]	Min	Typ	Max	

Inverter Switch

Static

Gate-emitter threshold voltage	$V_{GE(th)}$	$V_{CE} = V_{GE}$			0,00048	25	4,1	5,1	5,7	V
Collector-emitter saturation voltage	$V_{CE(sat)}$		15		30	25 125 150		1,73 1,97 2,01	1,8 ⁽¹⁾	V
Collector-emitter cut-off current	I_{CES}		0	600		25			1,6	μA
Gate-emitter leakage current	I_{GES}		20	0		25			100	nA
Internal gate resistance	r_g							None		Ω
Input capacitance	C_{ies}							1050		pF
Output capacitance	C_{oes}	$f = 1$ Mhz	0	25		25		45		pF
Reverse transfer capacitance	C_{res}							36		pF
Gate charge	Q_g	$V_{CC} = 480$ V	15		30	25		130		nC

Thermal

Thermal resistance junction to sink ⁽²⁾	$R_{th(j-s)}$	$\lambda_{paste} = 3,4$ W/mK (PSX)						1,63		K/W
--	---------------	------------------------------------	--	--	--	--	--	------	--	-----

Dynamic

Turn-on delay time	$t_{d(on)}$					25 125 150		37 38 38		ns
Rise time	t_r					25 125 150		12 13 15		ns
Turn-off delay time	$t_{d(off)}$					25 125 150		90 109 113		ns
Fall time	t_f					25 125 150		12 19,35 23,06		ns
Turn-on energy (per pulse)	E_{on}	$Q_{tFWD} = 0,812$ μC $Q_{tFWD} = 1,81$ μC $Q_{tFWD} = 2,02$ μC				25 125 150		0,758 0,981 1,04		mWs
Turn-off energy (per pulse)	E_{off}					25 125 150		0,233 0,422 0,469		mWs



Vincotech

10-FZ06PPA030SJ-LS54E08
datasheet

Characteristic Values

Parameter	Symbol	Conditions					Values			Unit
		V_{GE} [V] V_{GS} [V]	V_{CE} [V] V_{DS} [V] V_F [V]	I_C [A] I_D [A] I_F [A]	T_j [°C]	Min	Typ	Max		
Inverter Diode										
Static										
Forward voltage	V_F				20	25 125	1,25	1,71 1,58	1,95 ⁽¹⁾	V
Reverse leakage current	I_R	$V_i = 600$ V				25			27	μA
Thermal										
Thermal resistance junction to sink ⁽²⁾	$R_{th(j-s)}$	$\lambda_{paste} = 3,4$ W/mK (PSX)						2,6		K/W
Dynamic										
Peak recovery current	I_{RRM}	$di/dt=500$ A/μs $di/dt=1295$ A/μs $di/dt=1294$ A/μs	±15	350	30	25		7,86		A
						125		12,39		
						150		13,22		
Reverse recovery time	t_{rr}					25		200,95		
						125		276,23		
						150		327,76		
Recovered charge	Q_r					25		0,812		μC
						125		1,81		
						150		2,02		
Reverse recovered energy	E_{rec}					25		0,161		mWs
						125		0,388		
						150		0,431		
Peak rate of fall of recovery current	$(di_{rr}/dt)_{max}$					25		53,57		A/μs
						125		61,27		
						150		82,45		



Vincotech

Characteristic Values

Parameter	Symbol	Conditions					Values			Unit
		V_{GE} [V] V_{GS} [V]	V_{CE} [V] V_{DS} [V] V_F [V]	I_C [A] I_D [A] I_F [A]	T_j [°C]	Min	Typ	Max		

PFC Switch

Static

Gate-emitter threshold voltage	$V_{GE(th)}$	$V_{CE} = V_{GE}$			0,0005	25	3,3	4	4,7	V
Collector-emitter saturation voltage	$V_{CE(sat)}$		15		50	25 125		1,83 2,01	2,22 ⁽¹⁾	V
Collector-emitter cut-off current	I_{CES}		0	650		25			40	µA
Gate-emitter leakage current	I_{GES}		20	0		25			120	nA
Internal gate resistance	r_g							None		Ω
Input capacitance	C_{ies}	$f = 1 \text{ Mhz}$	0	25		25		3000		pF
Reverse transfer capacitance	C_{res}									
Gate charge	Q_g		15	520	50	25		120		nC

Thermal

Thermal resistance junction to sink ⁽²⁾	$R_{th(j-s)}$	$\lambda_{paste} = 3,4 \text{ W/mK}$ (PSX)						1,22		K/W
--	---------------	---	--	--	--	--	--	------	--	-----

Dynamic

Turn-on delay time	$t_{d(on)}$	$R_{gon} = 8 \Omega$ $R_{goff} = 8 \Omega$	±15	400	50	25		64,32		ns
Rise time	t_r					125		65,28		
						150		66,24		
						25		11,52		
Turn-off delay time	$t_{d(off)}$					125		13,12		
						150		13,44		
						25		65,28		
Fall time	t_f	125		81,28						
		150		84,48						
		25		6,5						
Turn-on energy (per pulse)	E_{on}	125		11,86						
		150		14,8						
		25		0,908						
Turn-off energy (per pulse)	E_{off}	125		1,42						
		150		1,58						
		25		0,324						
						125		0,511	mWs	
						150		0,565		



Vincotech

10-FZ06PPA030SJ-LS54E08
datasheet

Characteristic Values

Parameter	Symbol	Conditions					Values			Unit
		V_{GE} [V] V_{GS} [V]	V_{CE} [V] V_{DS} [V] V_F [V]	I_C [A] I_D [A] I_F [A]	T_j [°C]	Min	Typ	Max		
PFC Diode										
Static										
Forward voltage	V_F				70	25 125 150		1,79 1,52 1,48	1,65 ⁽¹⁾	V
Reverse leakage current	I_R	$V_T = 650$ V				25			15	μA
Thermal										
Thermal resistance junction to sink ⁽²⁾	$R_{th(j-s)}$	$\lambda_{paste} = 3,4$ W/mK (PSX)						1,11		K/W
Dynamic										
Peak recovery current	I_{RRM}					25 125 150		41,31 77,54 90,69		A
Reverse recovery time	t_{rr}					25 125 150		63,02 77,21 86,22		ns
Recovered charge	Q_r	$di/dt=3081$ A/μs $di/dt=3116$ A/μs $di/dt=3099$ A/μs	±15	400	50	25 125 150		1,11 3,25 4,17		μC
Reverse recovered energy	E_{rec}					25 125 150		0,227 0,715 0,954		mWs
Peak rate of fall of recovery current	$(di_r/dt)_{max}$					25 125 150		2590 2053 2349		A/μs



Vincotech

Characteristic Values

Parameter	Symbol	Conditions					Values			Unit
		V_{GE} [V] V_{GS} [V]	V_{CE} [V] V_{DS} [V] V_F [V]	I_C [A] I_D [A] I_F [A]	T_j [°C]	Min	Typ	Max		

PFC Sw. Protection Diode

Static

Forward voltage	V_F				6	25 125 150	1,23	1,72 1,58 1,53	1,87 ⁽¹⁾	V
Reverse leakage current	I_R	$V_r = 650$ V				25			0,1	μA

Thermal

Thermal resistance junction to sink ⁽²⁾	$R_{th(j-s)}$	$\lambda_{paste} = 3,4$ W/mK (PSX)						2,65		K/W
--	---------------	---------------------------------------	--	--	--	--	--	------	--	-----

Shunt

Static

Resistance	R							1		mΩ
Temperature coefficient	tc								275	ppm/K

Capacitor (PFC)

Static

Capacitance	C							33		nF
Tolerance								-5	5	%



Vincotech

Characteristic Values

Parameter	Symbol	Conditions					Values			Unit
		V_{GS} [V]	V_{GE} [V]	V_{DS} [V]	V_{CE} [V]	T_j [°C]	Min	Typ	Max	

Thermistor

Static

Rated resistance	R					25		22		kΩ
Deviation of R_{100}	$A_{R/R}$	$R_{100} = 1484 \Omega$				100	-5		5	%
Power dissipation	P							5		mW
Power dissipation constant	d					25		1,5		mW/K
B-value	$B_{(25/50)}$	Tol. $\pm 1 \%$						3962		K
B-value	$B_{(25/100)}$	Tol. $\pm 1 \%$						4000		K
Vincotech Thermistor Reference									I	

⁽¹⁾ Value at chip level

⁽²⁾ Only valid with pre-applied Vincotech thermal interface material.



Inverter Switch Characteristics

figure 1. IGBT

Typical output characteristics
 $I_C = f(V_{CE})$

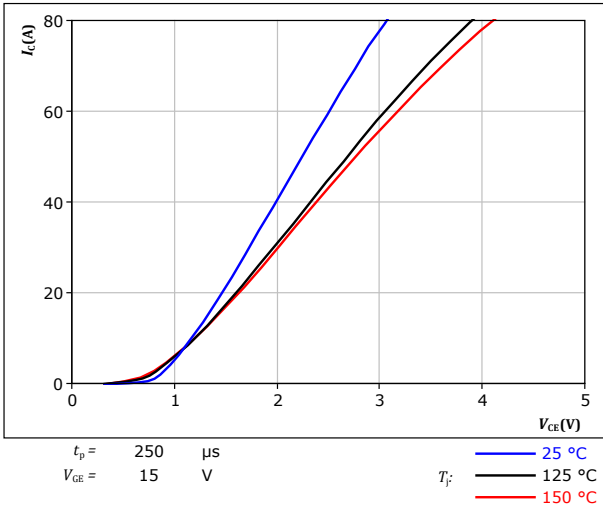

figure 2. IGBT

Typical output characteristics
 $I_C = f(V_{CE})$

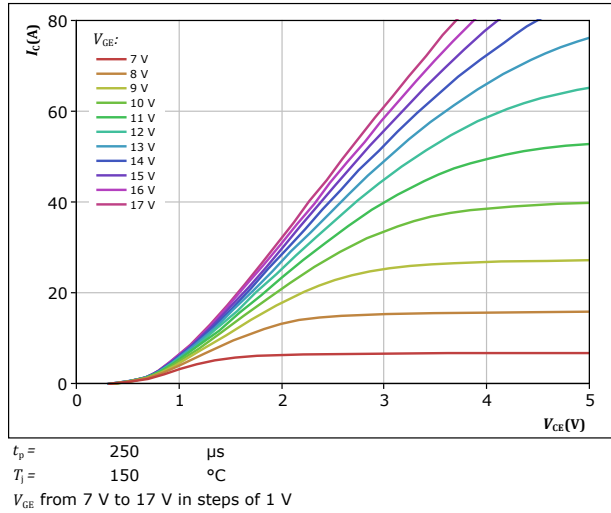

figure 3. IGBT

Typical transfer characteristics
 $I_C = f(V_{GE})$

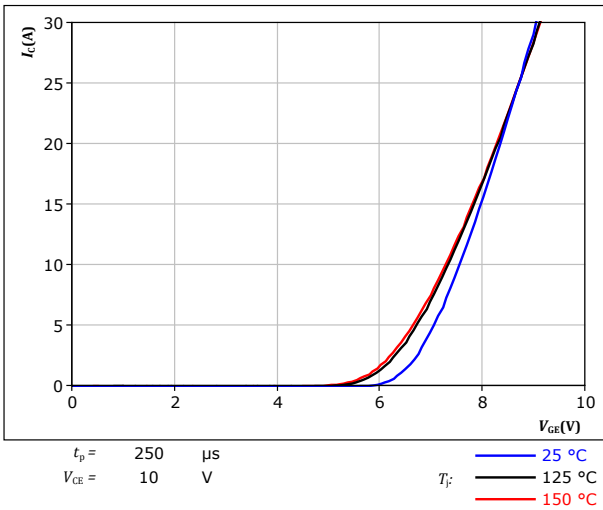
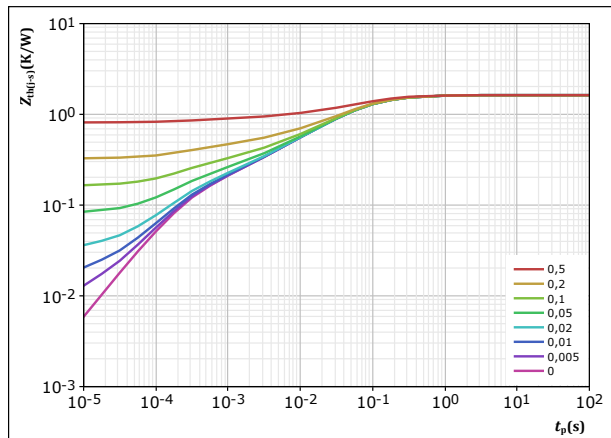

figure 4. IGBT

Transient thermal impedance as a function of pulse width
 $Z_{th(j-s)} = f(t_p)$



$D = t_p / T$
 $R_{th(j-s)} = 1,627 \text{ K/W}$

IGBT thermal model values

R (K/W)	τ (s)
1,74E-01	4,59E-01
8,46E-01	6,72E-02
3,30E-01	1,48E-02
1,44E-01	2,55E-03
1,34E-01	2,64E-04



Vincotech

Inverter Switch Characteristics

figure 5. IGBT

Safe operating area

$$I_C = f(V_{CE})$$

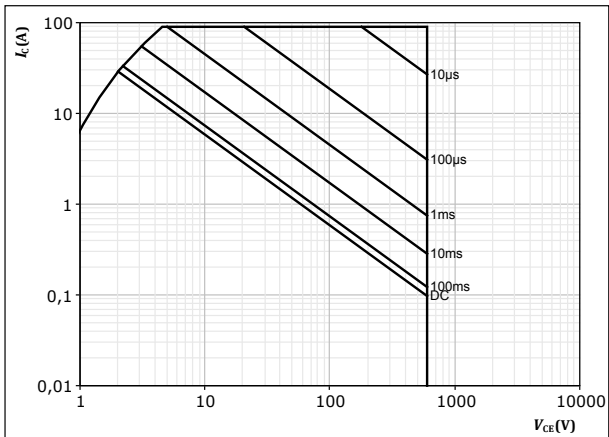

$D =$ single pulse
 $T_s = 80$ °C
 $V_{CE} = 15$ V
 $T_j = T_{jmax}$



Inverter Diode Characteristics

figure 6. FWD

Typical forward characteristics

$$I_F = f(V_F)$$

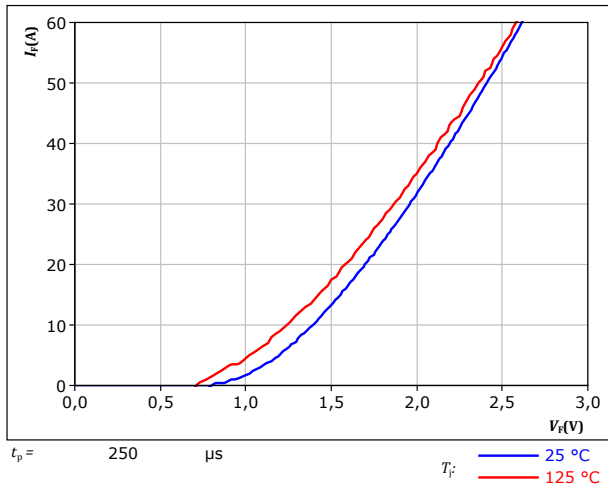
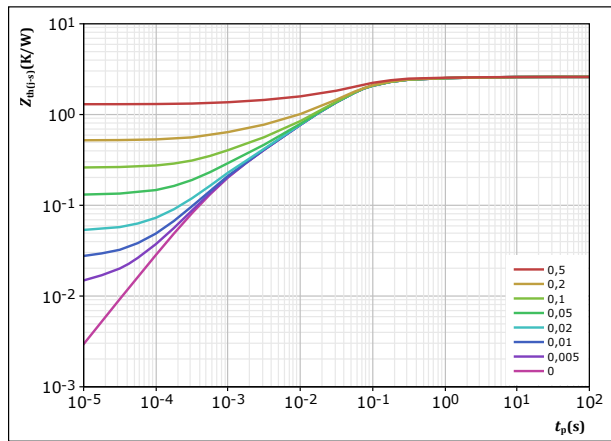

figure 7. FWD

Transient thermal impedance as a function of pulse width

$$Z_{th(j-s)} = f(t_p)$$



$D =$	t_p / T	
$R_{th(j-s)} =$	2,598	K/W
FWD thermal model values		
R (K/W)	τ (s)	
6,56E-02	4,59E+00	
1,58E-01	5,68E-01	
8,97E-01	8,41E-02	
1,05E+00	3,28E-02	
2,75E-01	4,96E-03	
1,51E-01	7,65E-04	



PFC Switch Characteristics

figure 8. IGBT

Typical output characteristics
 $I_C = f(V_{CE})$

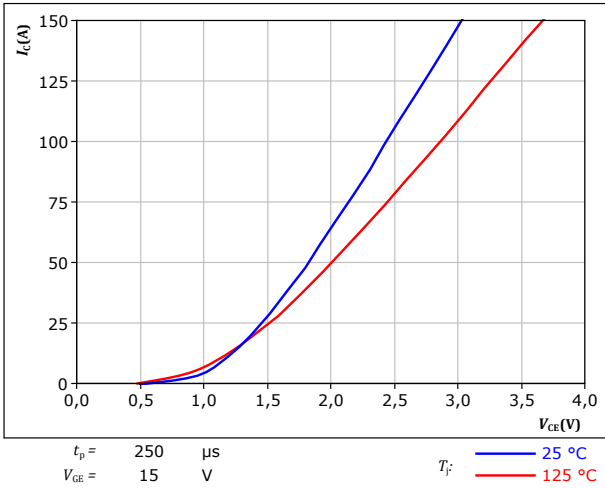

figure 9. IGBT

Typical output characteristics
 $I_C = f(V_{CE})$

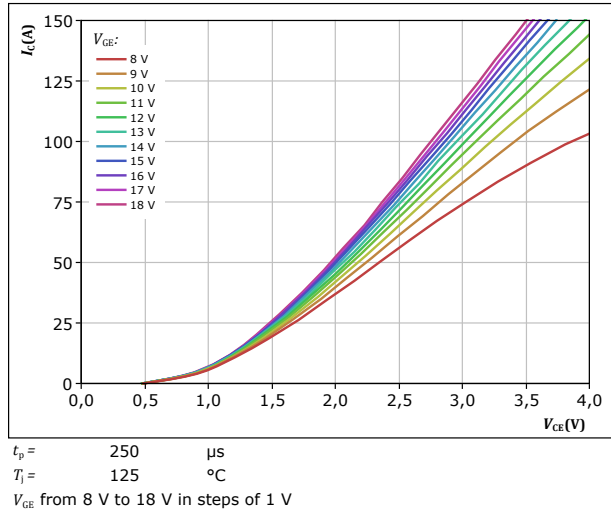

figure 10. IGBT

Typical transfer characteristics
 $I_C = f(V_{GE})$

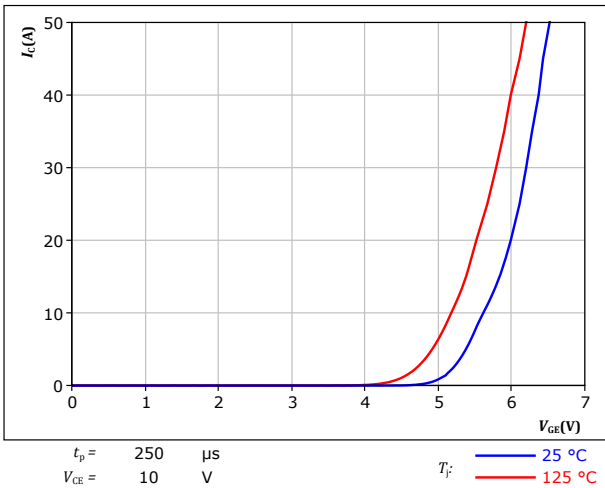
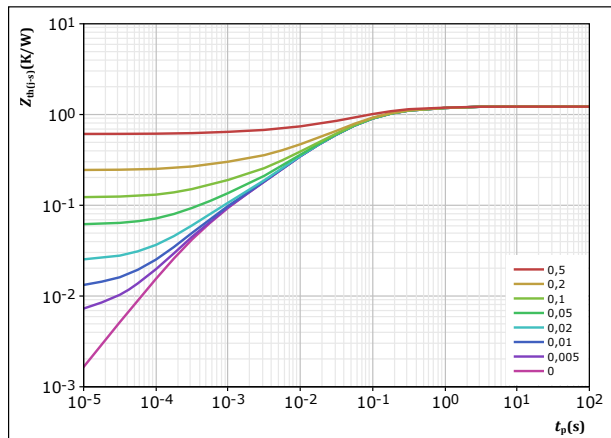

figure 11. IGBT

Transient thermal impedance as a function of pulse width
 $Z_{th(j-s)} = f(t_p)$



IGBT thermal model values

R (K/W)	τ (s)
1,28E-01	8,75E-01
4,40E-01	1,12E-01
3,96E-01	3,56E-02
1,75E-01	7,55E-03
3,44E-02	1,97E-03
4,80E-02	4,33E-04



PFC Switch Characteristics

figure 12. IGBT

Safe operating area

$$I_C = f(V_{CE})$$

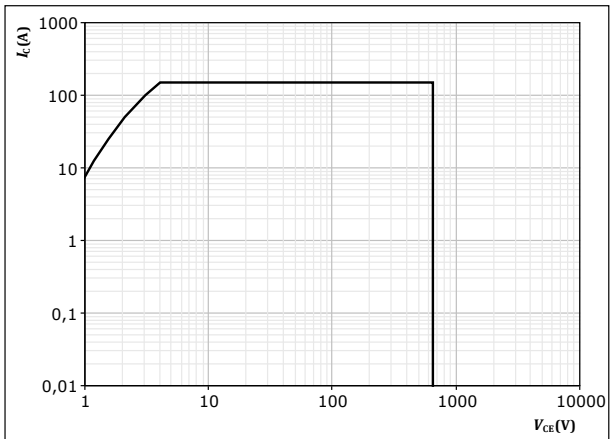

$D =$ single pulse
 $T_s = 80$ °C
 $V_{CE} = 15$ V
 $T_j = T_{jmax}$



PFC Diode Characteristics

figure 13. FWD

Typical forward characteristics

$$I_F = f(V_F)$$

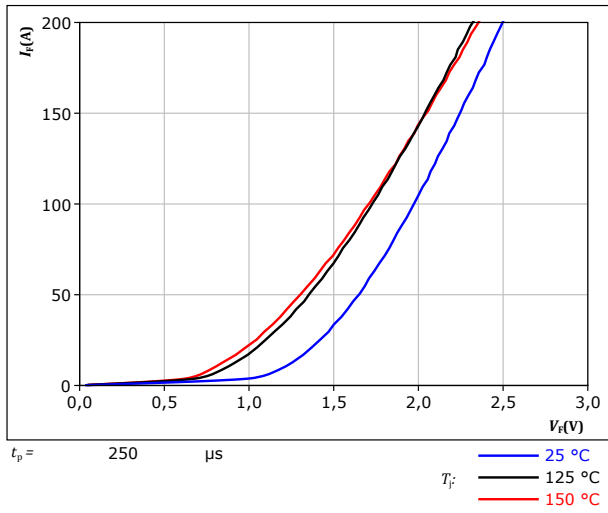
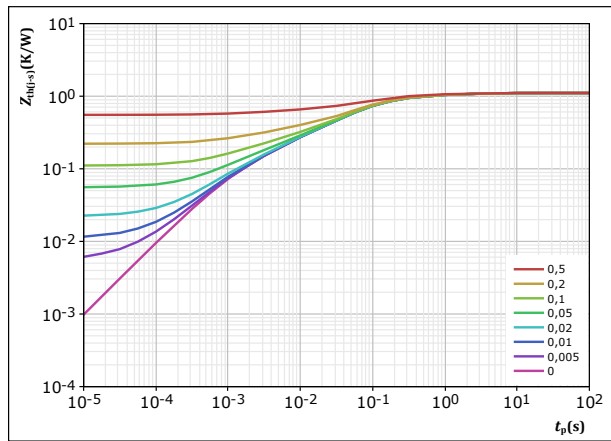

figure 14. FWD

Transient thermal impedance as a function of pulse width

$$Z_{th(j-s)} = f(t_p)$$



$D =$	t_p / T	
$R_{th(j-s)} =$	1,107	K/W
FWD thermal model values		
R (K/W)	τ (s)	
8,97E-02	2,23E+00	
2,36E-01	2,84E-01	
5,62E-01	6,41E-02	
1,48E-01	6,95E-03	
6,99E-02	1,04E-03	



Vincotech

PFC Sw. Protection Diode Characteristics

figure 15. FWD

Typical forward characteristics

$$I_F = f(V_F)$$

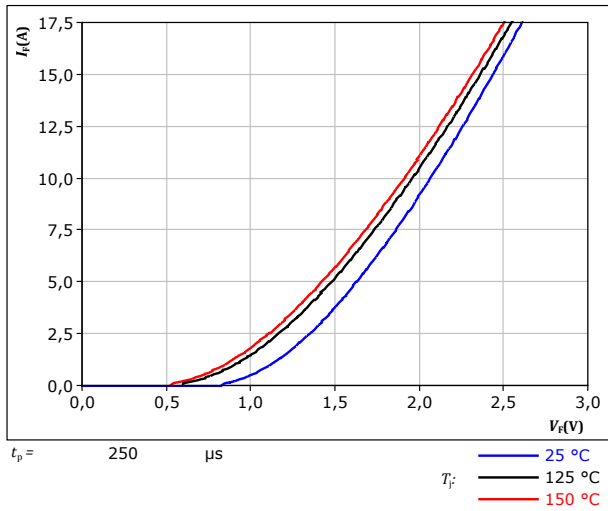
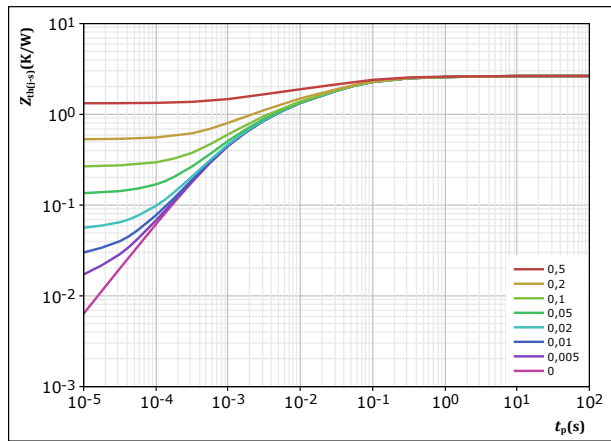

figure 16. FWD

Transient thermal impedance as a function of pulse width

$$Z_{th(j-s)} = f(t_p)$$



$D =$	t_p / T	
$R_{th(j-s)} =$	2,646	K/W
FWD thermal model values		
R (K/W)	τ (s)	
1,02E-01	2,56E+00	
3,50E-01	1,72E-01	
9,53E-01	3,96E-02	
7,66E-01	5,83E-03	
4,76E-01	9,87E-04	



Thermistor Characteristics

figure 17. Thermistor

Typical NTC characteristic as function of temperature

$$R_T = f(T)$$

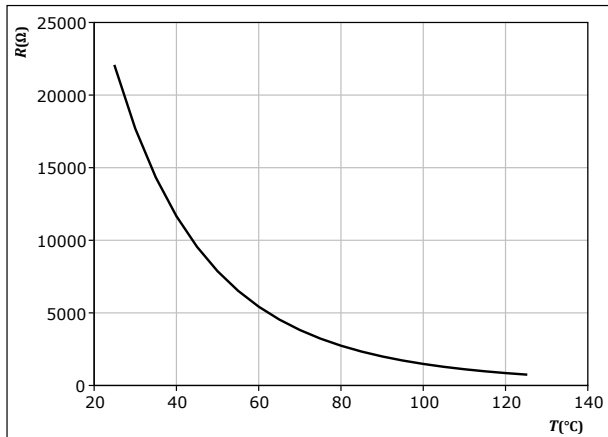



Inverter Switching Characteristics

figure 18. IGBT

Typical switching energy losses as a function of collector current
 $E = f(I_c)$

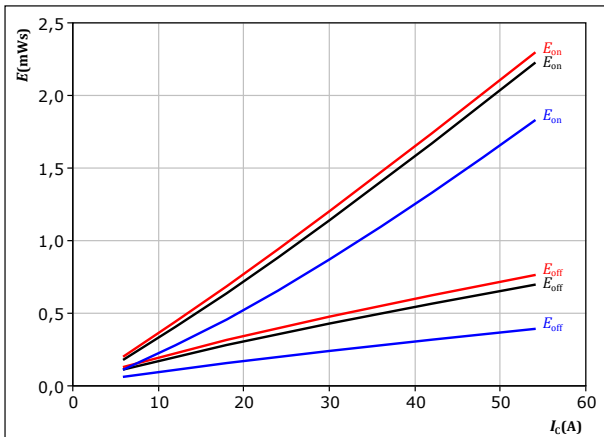

With an inductive load at
 $V_{CE} = 350$ V
 $V_{GE} = \pm 15$ V
 $R_{g(on)} = 8$ Ω
 $R_{g(off)} = 8$ Ω
 T_j : 25 °C (blue), 125 °C (black), 150 °C (red)

figure 19. IGBT

Typical switching energy losses as a function of gate resistor
 $E = f(R_g)$

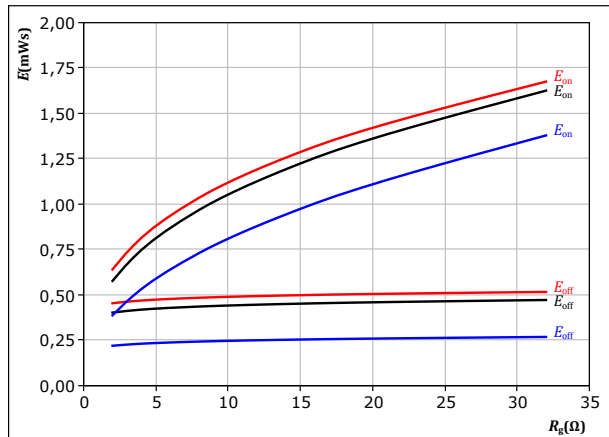

With an inductive load at
 $V_{CE} = 350$ V
 $V_{GE} = \pm 15$ V
 $I_c = 30$ A
 T_j : 25 °C (blue), 125 °C (black), 150 °C (red)

figure 20. FWD

Typical reverse recovered energy loss as a function of collector current
 $E_{rec} = f(I_c)$

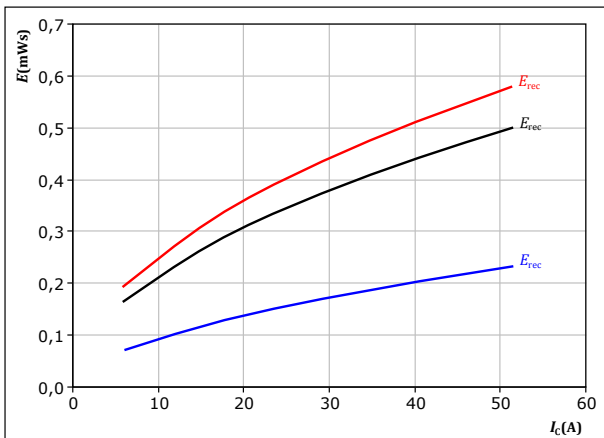

With an inductive load at
 $V_{CE} = 350$ V
 $V_{GE} = \pm 15$ V
 $R_{g(on)} = 8$ Ω
 T_j : 25 °C (blue), 125 °C (black), 150 °C (red)

figure 21. FWD

Typical reverse recovered energy loss as a function of gate resistor
 $E_{rec} = f(R_g)$

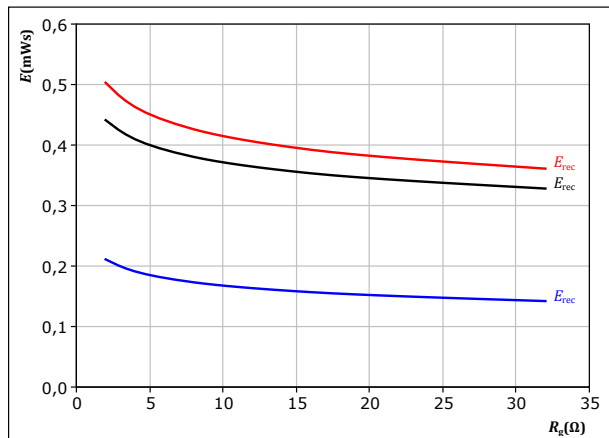

With an inductive load at
 $V_{CE} = 350$ V
 $V_{GE} = \pm 15$ V
 $I_c = 30$ A
 T_j : 25 °C (blue), 125 °C (black), 150 °C (red)



Inverter Switching Characteristics

figure 22. IGBT

Typical switching times as a function of collector current
 $t = f(I_c)$

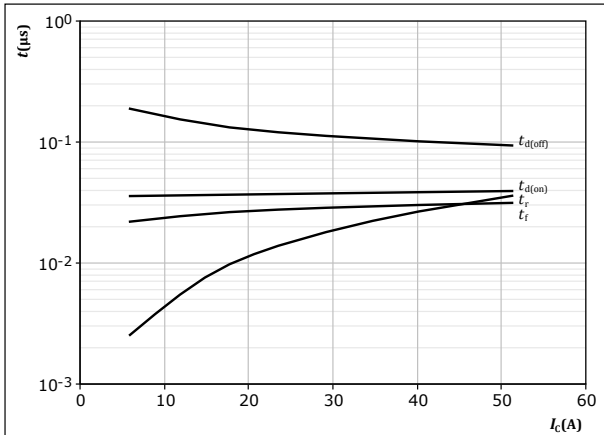

With an inductive load at
 $T_j = 150$ °C
 $V_{CE} = 350$ V
 $V_{GE} = \pm 15$ V
 $R_{gon} = 8$ Ω
 $R_{goff} = 8$ Ω

figure 23. IGBT

Typical switching times as a function of gate resistor
 $t = f(R_g)$

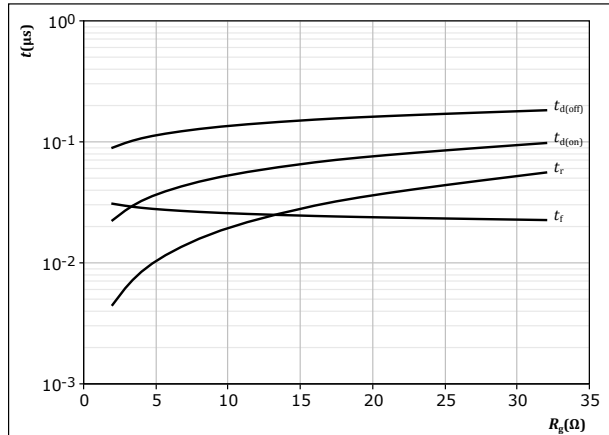

With an inductive load at
 $T_j = 150$ °C
 $V_{CE} = 350$ V
 $V_{GE} = \pm 15$ V
 $I_c = 30$ A

figure 24. FWD

Typical reverse recovery time as a function of collector current
 $t_{rr} = f(I_c)$

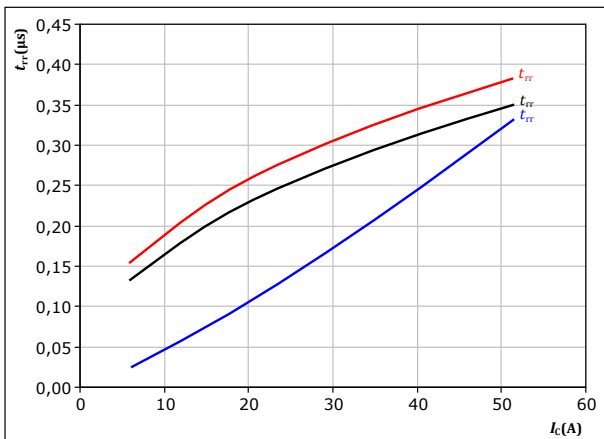

With an inductive load at
 $V_{CE} = 350$ V
 $V_{GE} = \pm 15$ V
 $R_{gon} = 8$ Ω
 $T_j:$ — 25 °C
— 125 °C
— 150 °C

figure 25. FWD

Typical reverse recovery time as a function of IGBT turn on gate resistor
 $t_{rr} = f(R_{gon})$

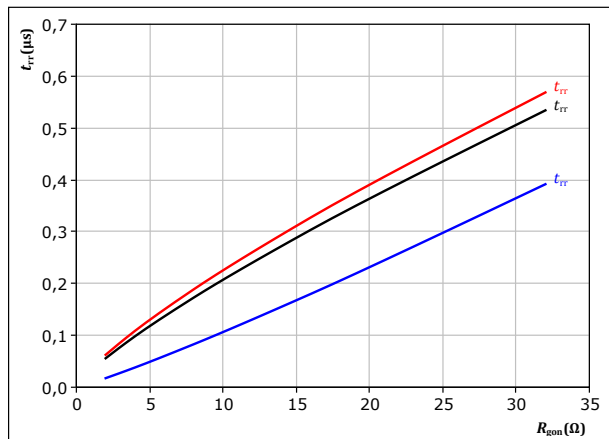

With an inductive load at
 $V_{CE} = 350$ V
 $V_{GE} = \pm 15$ V
 $I_c = 30$ A
 $T_j:$ — 25 °C
— 125 °C
— 150 °C



Inverter Switching Characteristics

figure 26. FWD

Typical recovered charge as a function of collector current

$$Q_r = f(I_c)$$

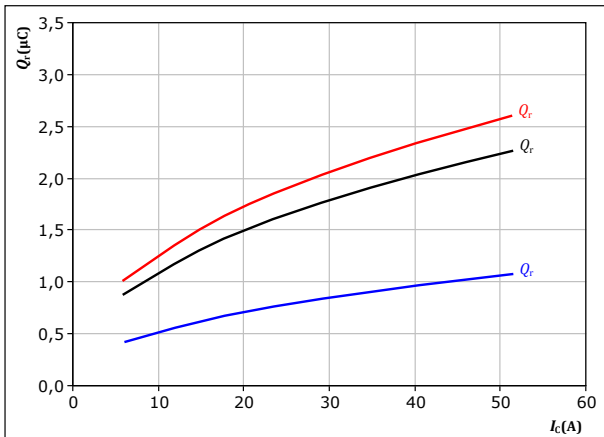

With an inductive load at

$V_{CE} = 350$ V
 $V_{GE} = \pm 15$ V
 $R_{gon} = 8$ Ω
 T_j : 25 °C (blue), 125 °C (black), 150 °C (red)

figure 27. FWD

Typical recovered charge as a function of turn on gate resistor

$$Q_r = f(R_{gon})$$

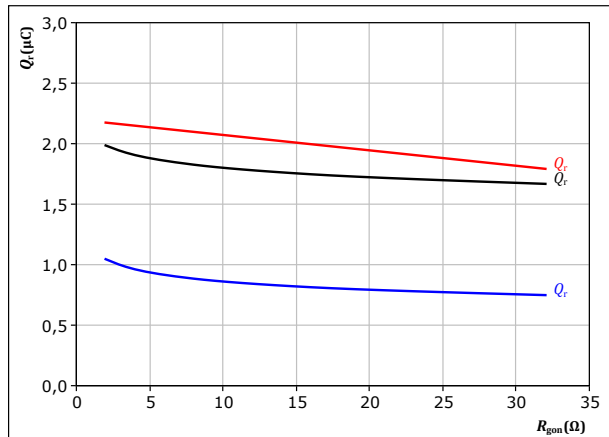

With an inductive load at

$V_{CE} = 350$ V
 $V_{GE} = \pm 15$ V
 $I_c = 30$ A
 T_j : 25 °C (blue), 125 °C (black), 150 °C (red)

figure 28. FWD

Typical peak reverse recovery current as a function of collector current

$$I_{RM} = f(I_c)$$

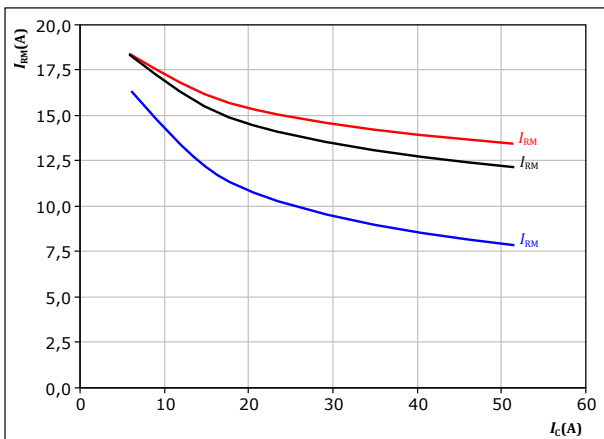

With an inductive load at

$V_{CE} = 350$ V
 $V_{GE} = \pm 15$ V
 $R_{gon} = 8$ Ω
 T_j : 25 °C (blue), 125 °C (black), 150 °C (red)

figure 29. FWD

Typical peak reverse recovery current as a function of turn on gate resistor

$$I_{RM} = f(R_{gon})$$

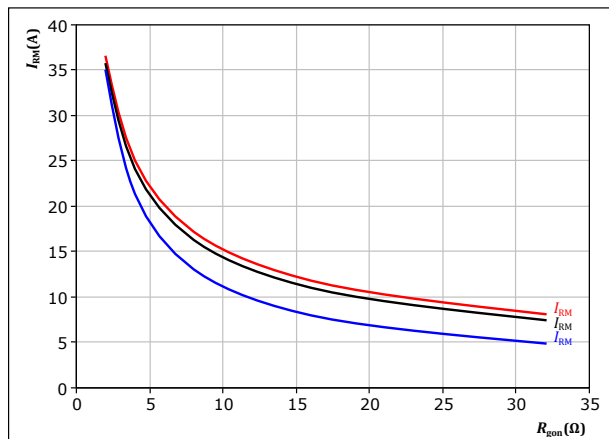

With an inductive load at

$V_{CE} = 350$ V
 $V_{GE} = \pm 15$ V
 $I_c = 30$ A
 T_j : 25 °C (blue), 125 °C (black), 150 °C (red)



Inverter Switching Characteristics

figure 30. FWD

Typical rate of fall of forward and reverse recovery current as a function of collector current
 $di_f/dt, di_{rr}/dt = f(I_c)$

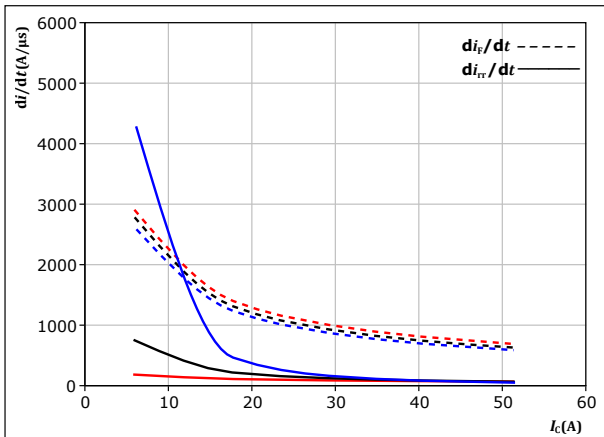

With an inductive load at

$V_{CE} = 350 \text{ V}$	$T_j = 25 \text{ }^\circ\text{C}$
$V_{GE} = \pm 15 \text{ V}$	$T_j = 125 \text{ }^\circ\text{C}$
$R_{gon} = 8 \text{ } \Omega$	$T_j = 150 \text{ }^\circ\text{C}$

figure 31. FWD

Typical rate of fall of forward and reverse recovery current as a function of turn on gate resistor
 $di_f/dt, di_{rr}/dt = f(R_{gon})$

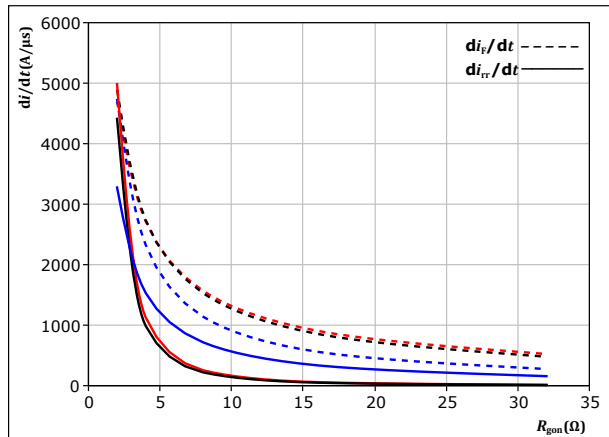

With an inductive load at

$V_{CE} = 350 \text{ V}$	$T_j = 25 \text{ }^\circ\text{C}$
$V_{GE} = \pm 15 \text{ V}$	$T_j = 125 \text{ }^\circ\text{C}$
$I_c = 30 \text{ A}$	$T_j = 150 \text{ }^\circ\text{C}$

figure 32. IGBT

Reverse bias safe operating area
 $I_c = f(V_{CE})$

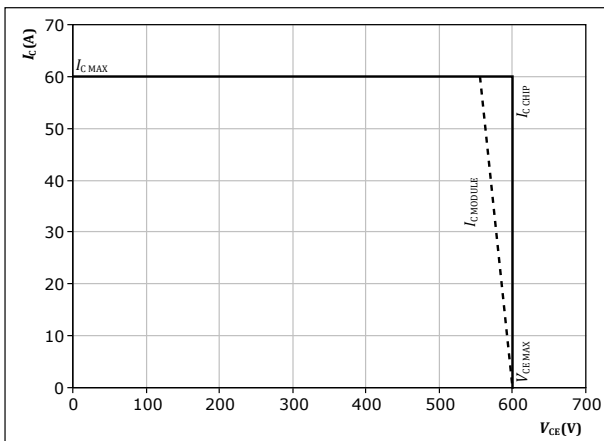

At $T_j = 150 \text{ }^\circ\text{C}$
 $R_{gon} = 8 \text{ } \Omega$
 $R_{goff} = 8 \text{ } \Omega$



PFC Switching Characteristics

figure 33. IGBT

Typical switching energy losses as a function of collector current
 $E = f(I_c)$

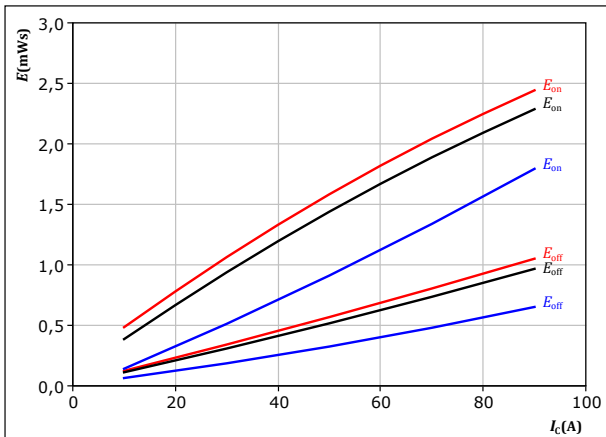

With an inductive load at
 $V_{CE} = 400$ V
 $V_{GE} = \pm 15$ V
 $R_{gon} = 8$ Ω
 $R_{goff} = 8$ Ω
 T_j : 25 °C, 125 °C, 150 °C

figure 34. IGBT

Typical switching energy losses as a function of gate resistor
 $E = f(R_g)$

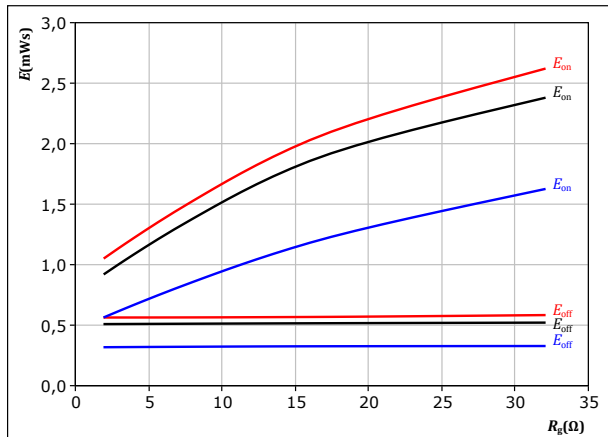

With an inductive load at
 $V_{CE} = 400$ V
 $V_{GE} = \pm 15$ V
 $I_c = 50$ A
 T_j : 25 °C, 125 °C, 150 °C

figure 35. FWD

Typical reverse recovered energy loss as a function of collector current
 $E_{rec} = f(I_c)$

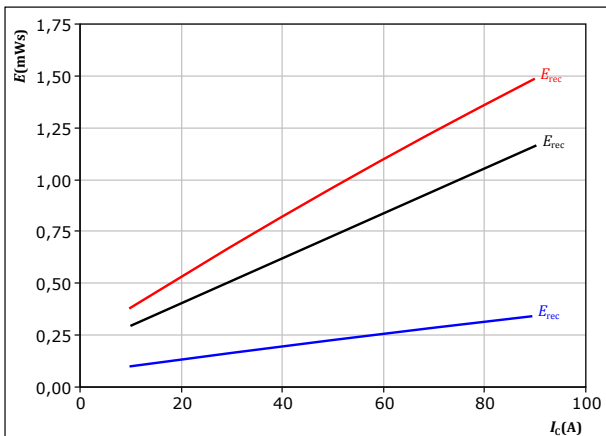

With an inductive load at
 $V_{CE} = 400$ V
 $V_{GE} = \pm 15$ V
 $R_{gon} = 8$ Ω
 T_j : 25 °C, 125 °C, 150 °C

figure 36. FWD

Typical reverse recovered energy loss as a function of gate resistor
 $E_{rec} = f(R_g)$

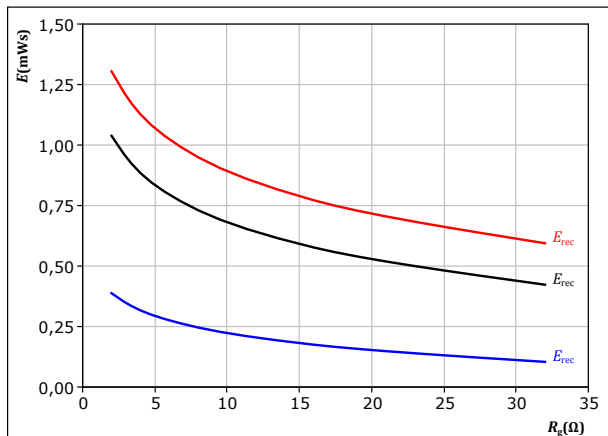

With an inductive load at
 $V_{CE} = 400$ V
 $V_{GE} = \pm 15$ V
 $I_c = 50$ A
 T_j : 25 °C, 125 °C, 150 °C



PFC Switching Characteristics

figure 37. IGBT

Typical switching times as a function of collector current
 $t = f(I_c)$

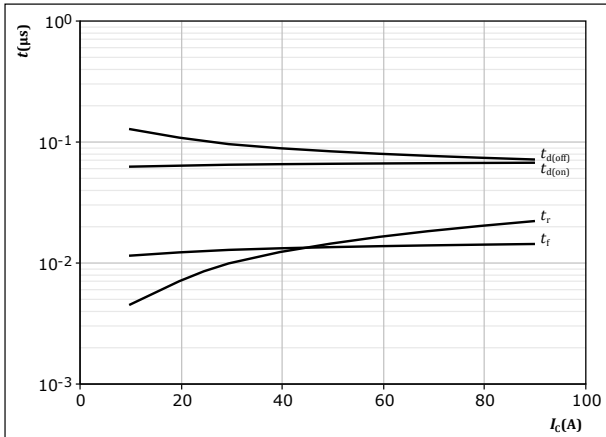

With an inductive load at
 $T_j = 150 \text{ }^\circ\text{C}$
 $V_{CE} = 400 \text{ V}$
 $V_{GE} = \pm 15 \text{ V}$
 $R_{gon} = 8 \text{ } \Omega$
 $R_{goff} = 8 \text{ } \Omega$

figure 38. IGBT

Typical switching times as a function of gate resistor
 $t = f(R_g)$

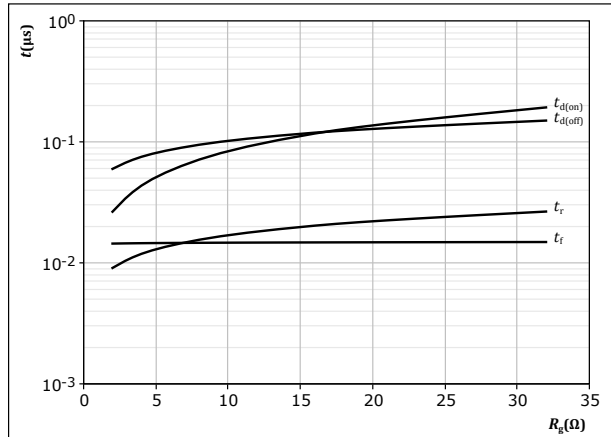

With an inductive load at
 $T_j = 150 \text{ }^\circ\text{C}$
 $V_{CE} = 400 \text{ V}$
 $V_{GE} = \pm 15 \text{ V}$
 $I_c = 50 \text{ A}$

figure 39. FWD

Typical reverse recovery time as a function of collector current
 $t_{rr} = f(I_c)$

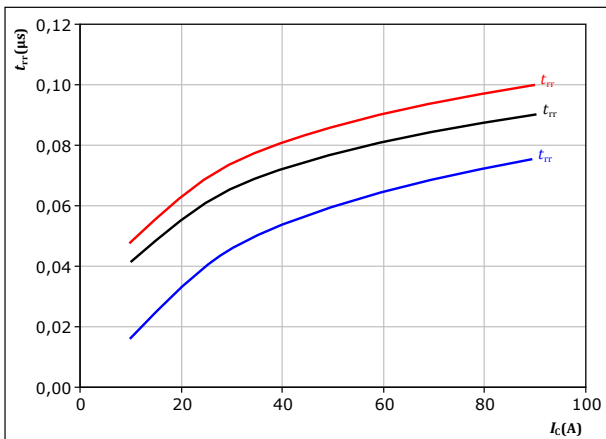

With an inductive load at
 $V_{CE} = 400 \text{ V}$
 $V_{GE} = \pm 15 \text{ V}$
 $R_{gon} = 8 \text{ } \Omega$

T_j :
— 25 $^\circ\text{C}$
— 125 $^\circ\text{C}$
— 150 $^\circ\text{C}$

figure 40. FWD

Typical reverse recovery time as a function of IGBT turn on gate resistor
 $t_{rr} = f(R_{gon})$

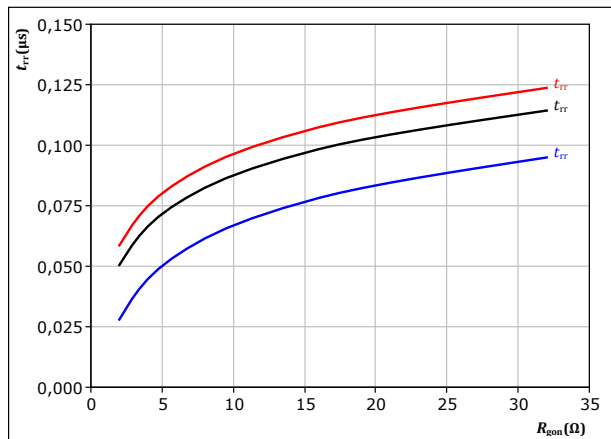

With an inductive load at
 $V_{CE} = 400 \text{ V}$
 $V_{GE} = \pm 15 \text{ V}$
 $I_c = 50 \text{ A}$

T_j :
— 25 $^\circ\text{C}$
— 125 $^\circ\text{C}$
— 150 $^\circ\text{C}$



PFC Switching Characteristics

figure 41. FWD

Typical recovered charge as a function of collector current

$$Q_r = f(I_c)$$

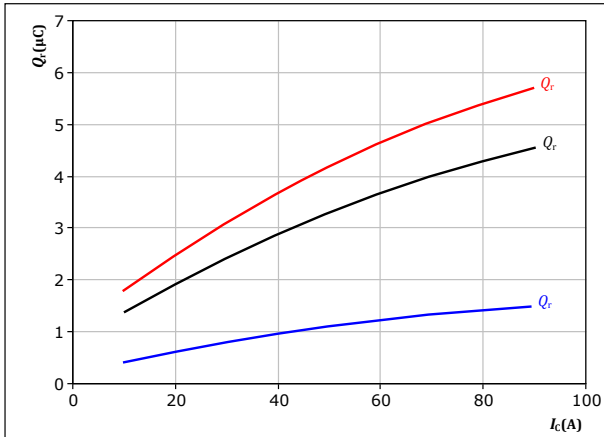

With an inductive load at

$V_{CE} = 400$ V
 $V_{GE} = \pm 15$ V
 $R_{gon} = 8$ Ω

T_j : — 25 °C
— 125 °C
— 150 °C

figure 42. FWD

Typical recovered charge as a function of turn on gate resistor

$$Q_r = f(R_{gon})$$

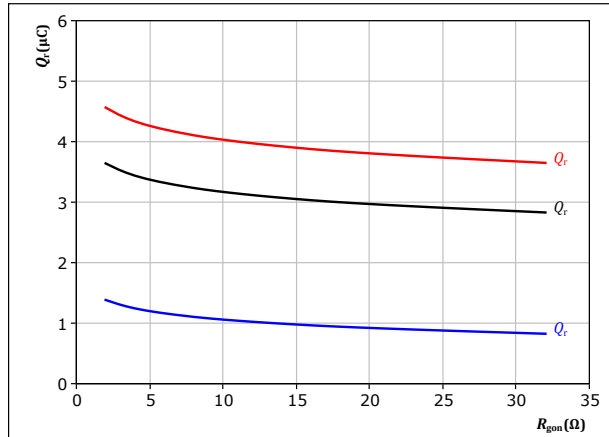

With an inductive load at

$V_{CE} = 400$ V
 $V_{GE} = \pm 15$ V
 $I_c = 50$ A

T_j : — 25 °C
— 125 °C
— 150 °C

figure 43. FWD

Typical peak reverse recovery current as a function of collector current

$$I_{RM} = f(I_c)$$

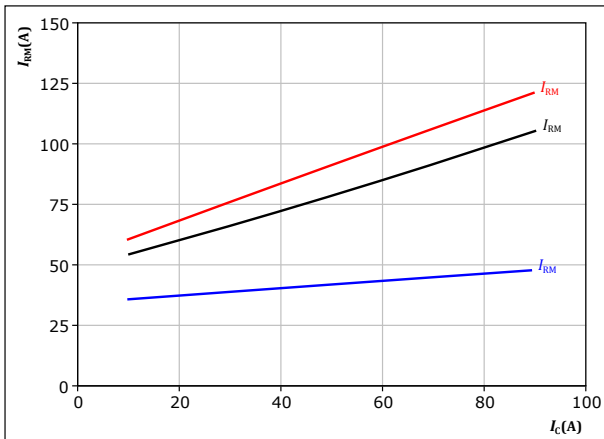

With an inductive load at

$V_{CE} = 400$ V
 $V_{GE} = \pm 15$ V
 $R_{gon} = 8$ Ω

T_j : — 25 °C
— 125 °C
— 150 °C

figure 44. FWD

Typical peak reverse recovery current as a function of turn on gate resistor

$$I_{RM} = f(R_{gon})$$

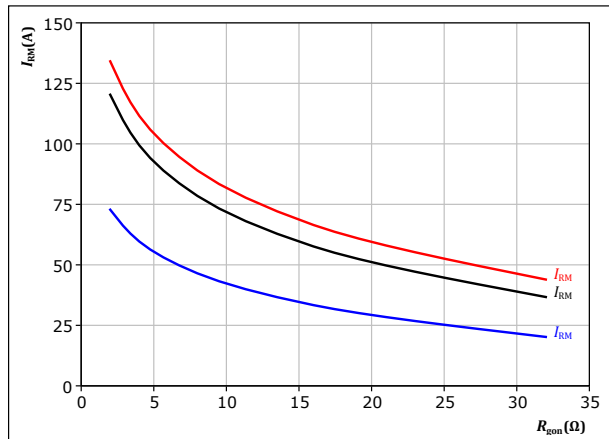

With an inductive load at

$V_{CE} = 400$ V
 $V_{GE} = \pm 15$ V
 $I_c = 50$ A

T_j : — 25 °C
— 125 °C
— 150 °C



PFC Switching Characteristics

figure 45. FWD

Typical rate of fall of forward and reverse recovery current as a function of collector current
 $di_f/dt, di_r/dt = f(I_c)$

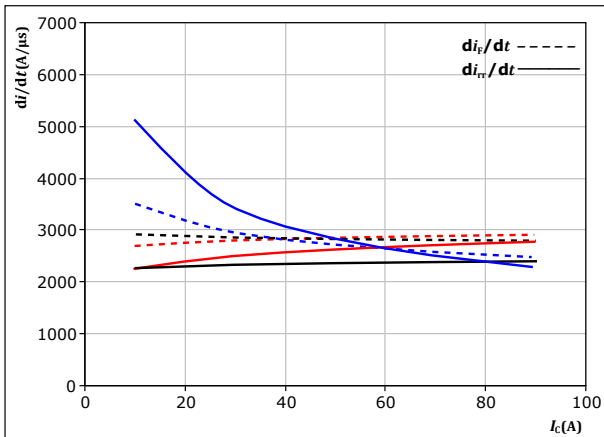

With an inductive load at

$V_{CE} = 400$ V
 $V_{GE} = \pm 15$ V
 $R_{gon} = 8$ Ω

T_j :
— 25 °C
— 125 °C
— 150 °C

figure 46. FWD

Typical rate of fall of forward and reverse recovery current as a function of turn on gate resistor
 $di_f/dt, di_r/dt = f(R_{gon})$

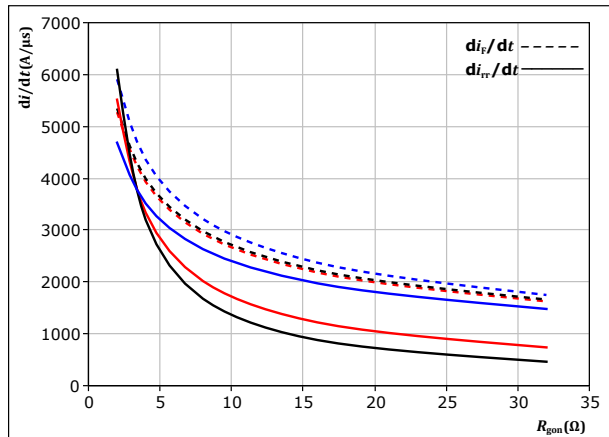

With an inductive load at

$V_{CE} = 400$ V
 $V_{GE} = \pm 15$ V
 $I_c = 50$ A

T_j :
— 25 °C
— 125 °C
— 150 °C

figure 47. IGBT

Reverse bias safe operating area

$I_c = f(V_{CE})$

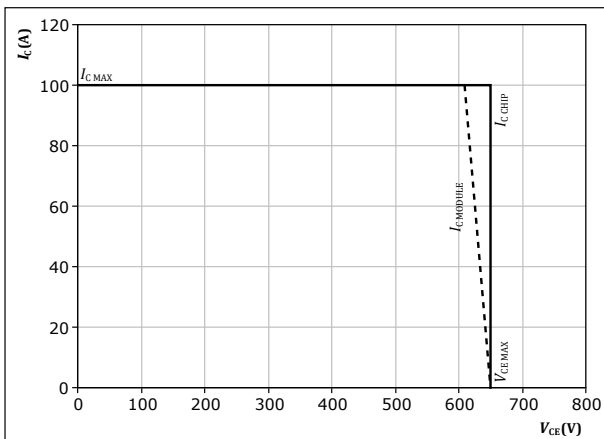

At $T_j = 150$ °C
 $R_{gon} = 8$ Ω
 $R_{goff} = 8$ Ω



Switching Definitions

figure 48. IGBT

Turn-off Switching Waveforms & definition of t_{doff} , t_{Eoff} (t_{Eoff} = integrating time for E_{off})

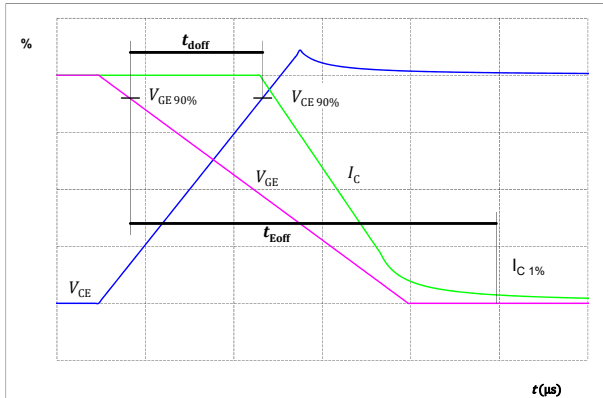

figure 49. IGBT

Turn-on Switching Waveforms & definition of t_{don} , t_{Eon} (t_{Eon} = integrating time for E_{on})

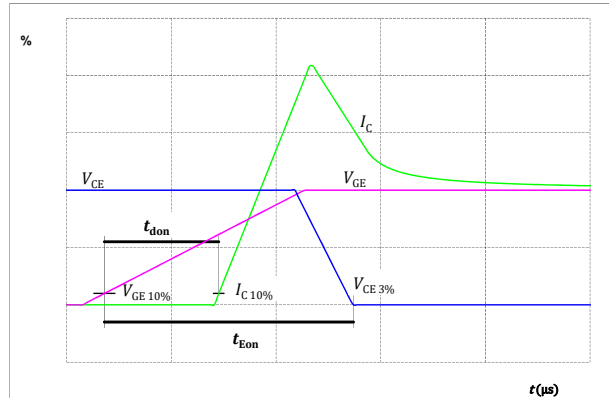

figure 50. IGBT

Turn-off Switching Waveforms & definition of t_f

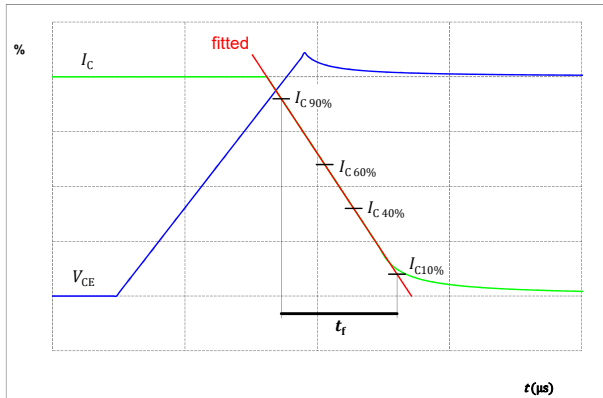
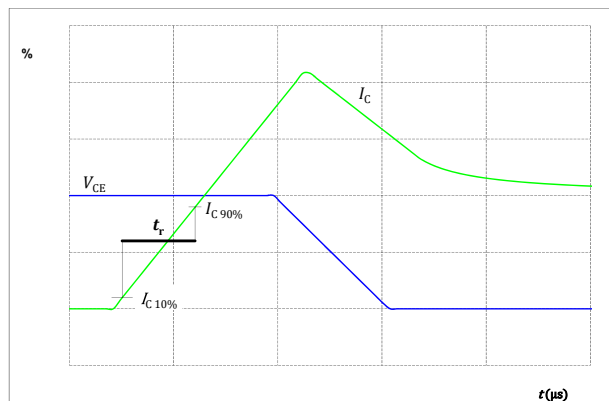

figure 51. IGBT

Turn-on Switching Waveforms & definition of t_r





Switching Definitions

figure 52. FWD

Turn-off Switching Waveforms & definition of t_{rr}

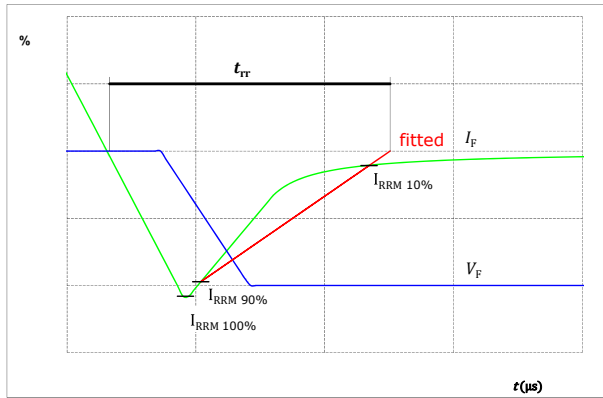
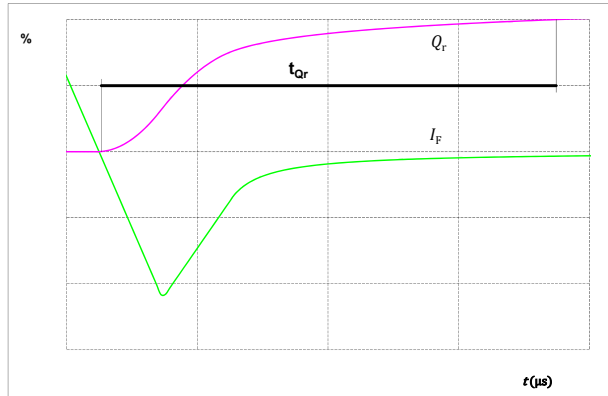

figure 53. FWD

Turn-on Switching Waveforms & definition of t_{Qr} (t_{Qr} = integrating time for Q_r)





Vincotech

10-FZ06PPA030SJ-LS54E08
datasheet

Ordering Code	
Version	Ordering Code
Without thermal paste	10-FZ06PPA030SJ-LS54E08
With thermal paste	10-FZ06PPA030SJ-LS54E08-/3/

Marking						
	Text	Name NN-NNNNNNNNNNNNNN- TTTTTVV	Date code WWYY	UL & VIN UL VIN	Lot LLLLL	Serial SSSS
	Datamatrix	Type&Ver TTTTTTTV	Lot number LLLLL	Serial SSSS	Date code WWYY	

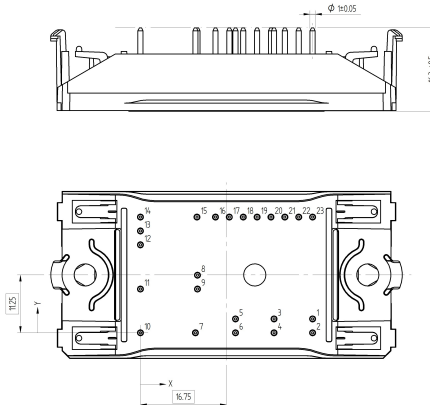
Pin table [mm]				Outline	
Pin	X	Y	Function	 <p style="font-size: small;">Tolerance of pin positions: $\pm 0.5\text{mm}$ at the end of pins Dimension of coordinate axis is only offset without tolerance</p>	
1	33,5	2,7	G12		
2	33,5	0	Ph1		
3	26	2,7	G14		
4	26	0	Ph2		
5	18,5	2,7	G16		
6	18,5	0	Ph3		
7	10,7	0	DC+Inv		
8	11,1	11,2	Therm1		
9	11,1	8,5	Therm2		
10	0	0	PFC		
11	0	8,5	DC+PFC		
12	0	17,1	S1sh1		
13	0	19,8	S2sh1		
14	0	22,5	DC-Rect		
15	11	22,5	DC-PFC		
16	14,6	22,5	S27		
17	17,3	22,5	G27		
18	20	22,5	G15		
19	22,7	22,5	DC-3		
20	25,4	22,5	G13		
21	28,1	22,5	DC-2		
22	30,8	22,5	G11		
23	33,5	22,5	DC-1		



Vincotech

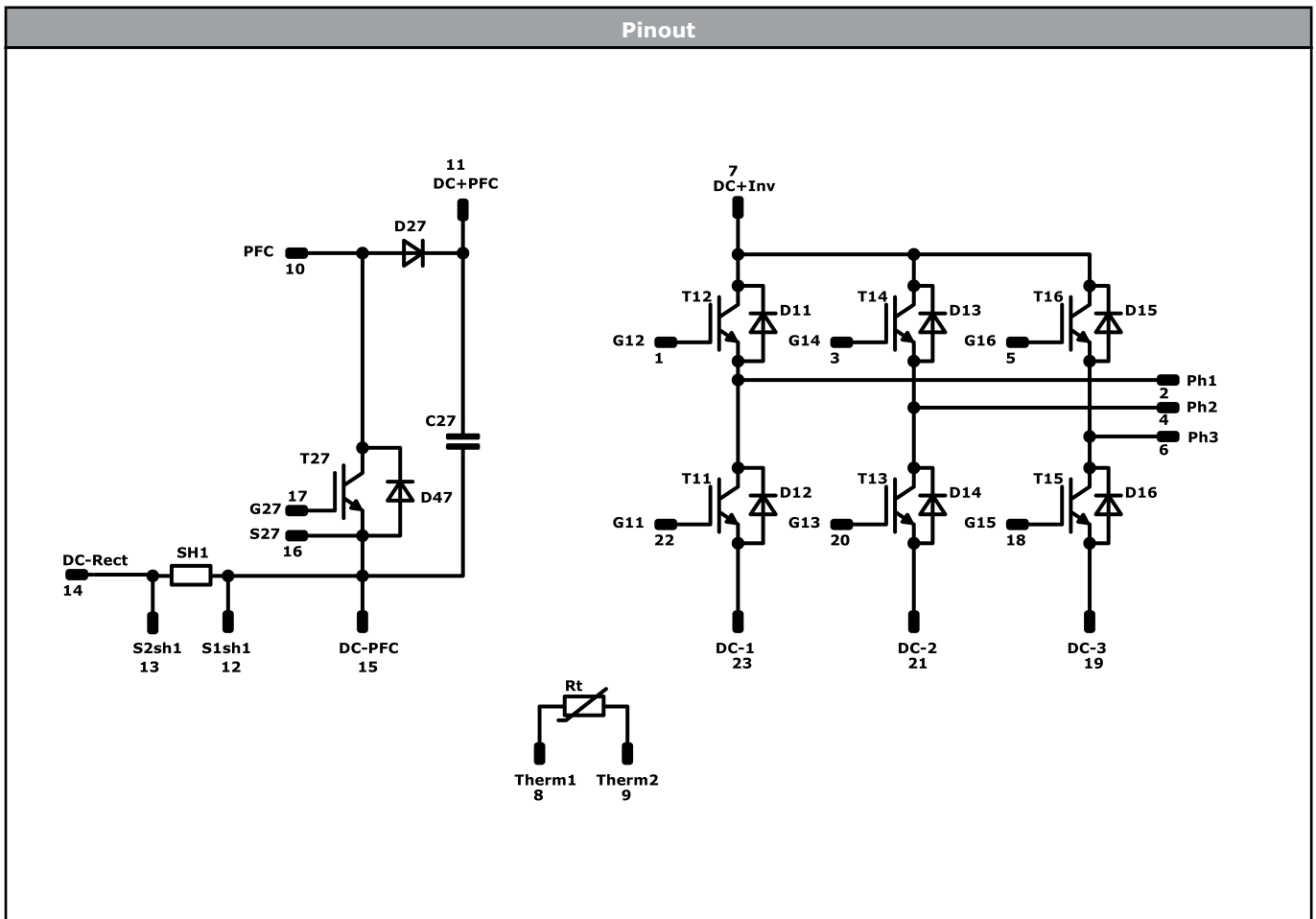

Identification					
ID	Component	Voltage	Current	Function	Comment
T11, T12, T13, T14, T15, T16	IGBT	600 V	30 A	Inverter Switch	
D11, D12, D13, D14, D15, D16	FWD	600 V	20 A	Inverter Diode	
T27	IGBT	650 V	50 A	PFC Switch	
D27	FWD	650 V	70 A	PFC Diode	
D47	FWD	650 V	6 A	PFC Sw. Protection Diode	
SH1	Shunt			Shunt	
C27	Capacitor	630 V		Capacitor (PFC)	
Rt	Thermistor			Thermistor	



Packaging instruction				
Standard packaging quantity (SPQ) 135	>SPQ	Standard	<SPQ	Sample

Handling instruction
Handling instructions for <i>flow 0</i> packages see vincotech.com website.

Package data
Package data for <i>flow 0</i> packages see vincotech.com website.

UL recognition and file number
This device is certified according to UL 1557 standard, UL file number E192116. For more information see vincotech.com website. 

Document No.:	Date:	Modification:	Pages
10-FZ06PPA030SJ-LS54E08-D1-14	10 Jun. 2020		

DISCLAIMER

The information, specifications, procedures, methods and recommendations herein (together "information") are presented by Vincotech to reader in good faith, are believed to be accurate and reliable, but may well be incomplete and/or not applicable to all conditions or situations that may exist or occur. Vincotech reserves the right to make any changes without further notice to any products to improve reliability, function or design. No representation, guarantee or warranty is made to reader as to the accuracy, reliability or completeness of said information or that the application or use of any of the same will avoid hazards, accidents, losses, damages or injury of any kind to persons or property or that the same will not infringe third parties rights or give desired results. It is reader's sole responsibility to test and determine the suitability of the information and the product for reader's intended use.

LIFE SUPPORT POLICY

Vincotech products are not authorised for use as critical components in life support devices or systems without the express written approval of Vincotech.

As used herein:

1. Life support devices or systems are devices or systems which, (a) are intended for surgical implant into the body, or (b) support or sustain life, or (c) whose failure to perform when properly used in accordance with instructions for use provided in labelling can be reasonably expected to result in significant injury to the user.
2. A critical component is any component of a life support device or system whose failure to perform can be reasonably expected to cause the failure of the life support device or system, or to affect its safety or effectiveness.

单击下面可查看定价，库存，交付和生命周期等信息

[>>Vincotech\(威科\)](#)