

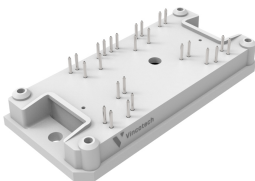

flowBOOST 1 dual		950 V / 100 A	
Features		flow 1 12 mm housing	
<ul style="list-style-type: none">• Dual Booster• High Performance Flying Capacitor Topology• Latest IGBT & SiC Technology• Integrated flying snubber capacitor• Integrated NTC• Low Inductance Design			
Target applications		Schematic	
<ul style="list-style-type: none">• Solar Inverters			
Types			
<ul style="list-style-type: none">• 10-FY10B2A100S7-LP26L06			

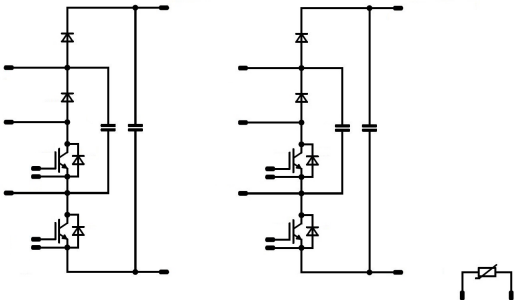

Vincotech

10-FY10B2A100S7-LP26L06
datasheet

Maximum Ratings

$T_j = 25\text{ °C}$, unless otherwise specified

Parameter	Symbol	Conditions	Value	Unit
Inner Boost Switch				
Collector-emitter voltage	V_{CES}		950	V
Collector current (DC current)	I_C	$T_j = T_{jmax}$ $T_s = 80\text{ °C}$	58	A
Repetitive peak collector current	I_{CRM}	t_p limited by T_{jmax}	200	A
Total power dissipation	P_{tot}	$T_j = T_{jmax}$ $T_s = 80\text{ °C}$	94	W
Gate-emitter voltage	V_{GES}		± 20	V
Maximum junction temperature	T_{jmax}		150	°C
Outer Boost Switch				
Collector-emitter voltage	V_{CES}		950	V
Collector current (DC current)	I_C	$T_j = T_{jmax}$ $T_s = 80\text{ °C}$	58	A
Repetitive peak collector current	I_{CRM}	t_p limited by T_{jmax}	200	A
Total power dissipation	P_{tot}	$T_j = T_{jmax}$ $T_s = 80\text{ °C}$	94	W
Gate-emitter voltage	V_{GES}		± 20	V
Maximum junction temperature	T_{jmax}		150	°C
Inner Boost Diode				
Peak repetitive reverse voltage	V_{RRM}		1200	V
Forward current (DC current)	I_F	$T_j = T_{jmax}$ $T_s = 80\text{ °C}$	39	A
Repetitive peak forward current	I_{FRM}	t_p limited by T_{jmax}	141	A
Surge (non-repetitive) forward current	I_{FSM}	Single Half Sine Wave, $t_p = 10\text{ ms}$	213	A
Total power dissipation	P_{tot}	$T_j = T_{jmax}$ $T_s = 80\text{ °C}$	105	W
Maximum junction temperature	T_{jmax}		175	°C



Vincotech

Maximum Ratings

$T_j = 25\text{ °C}$, unless otherwise specified

Parameter	Symbol	Conditions	Value	Unit
-----------	--------	------------	-------	------

Outer Boost Diode

Peak repetitive reverse voltage	V_{RRM}		1200	V
Forward current (DC current)	I_F	$T_j = T_{jmax}$ $T_s = 80\text{ °C}$	39	A
Repetitive peak forward current	I_{FRM}	t_p limited by T_{jmax}	141	A
Surge (non-repetitive) forward current	I_{FSM}	Single Half Sine Wave, $t_p = 10\text{ ms}$	213	A
Total power dissipation	P_{tot}	$T_j = T_{jmax}$ $T_s = 80\text{ °C}$	105	W
Maximum junction temperature	T_{jmax}		175	°C

Inner Boost Sw. Protection Diode

Peak repetitive reverse voltage	V_{RRM}		1200	V
Forward current (DC current)	I_F	$T_j = T_{jmax}$ $T_s = 80\text{ °C}$	40	A
Repetitive peak forward current	I_{FRM}	t_p limited by T_{jmax}	70	A
Total power dissipation	P_{tot}	$T_j = T_{jmax}$ $T_s = 80\text{ °C}$	75	W
Maximum junction temperature	T_{jmax}		175	°C

Outer Boost Sw. Protection Diode

Peak repetitive reverse voltage	V_{RRM}		1200	V
Forward current (DC current)	I_F	$T_j = T_{jmax}$ $T_s = 80\text{ °C}$	40	A
Repetitive peak forward current	I_{FRM}	t_p limited by T_{jmax}	70	A
Total power dissipation	P_{tot}	$T_j = T_{jmax}$ $T_s = 80\text{ °C}$	75	W
Maximum junction temperature	T_{jmax}		175	°C

Flying Capacitor

Maximum DC voltage	V_{MAX}		1000	V
Operation Temperature	T_{op}		0 ... 125	°C



Vincotech

Maximum Ratings

$T_j = 25\text{ °C}$, unless otherwise specified

Parameter	Symbol	Conditions	Value	Unit
Capacitor (DC)				
Maximum DC voltage	V_{MAX}		1500	V
Operation Temperature	T_{op}		0 ... 125	°C

Module Properties

Thermal Properties

Storage temperature	T_{stg}		-40...+125	°C
Operation temperature under switching condition	T_{jop}		-40...+($T_{jmax} - 25$)	°C

Isolation Properties

Isolation voltage	V_{isol}	DC Test Voltage* $t_p = 2\text{ s}$	6000	V
Isolation voltage	V_{isol}	AC Voltage $t_p = 1\text{ min}$	2500	V
Creepage distance			min. 12,7	mm
Clearance			12,15	mm
Comparative Tracking Index	CTI		≥ 600	

*100 % tested in production



Vincotech

Characteristic Values

Parameter	Symbol	Conditions					Values			Unit
		V_{GS} [V]	V_{GE} [V]	V_{DS} [V]	I_D [A]	T_j [°C]	Min	Typ	Max	

Inner Boost Switch

Static

Gate-emitter threshold voltage	$V_{GE(th)}$	$V_{CE} = V_{GE}$			0,00167	25	4,35	5,1	5,85	V
Collector-emitter saturation voltage	$V_{CE(sat)}$		15		100	25 125 150		1,67 1,94 2	2,35 ⁽¹⁾	V
Collector-emitter cut-off current	I_{CES}		0	950		25			2	μA
Gate-emitter leakage current	I_{GES}		20	0		25			100	nA
Internal gate resistance	r_g							1,5		Ω
Input capacitance	C_{ies}							6500		pF
Output capacitance	C_{oes}	$f = 100$ kHz	0	25		25		139		pF
Reverse transfer capacitance	C_{res}							20		pF
Gate charge	Q_g		15		0	25		230		nC

Thermal

Thermal resistance junction to sink ⁽²⁾	$R_{th(j-s)}$	$\lambda_{paste} = 3,4$ W/mK (PSX)						0,74		K/W
--	---------------	---------------------------------------	--	--	--	--	--	------	--	-----

Dynamic

Turn-on delay time	$t_{d(on)}$					25 125 150		92,64 94,24 94,72		ns
Rise time	t_r					25 125 150		8,32 9,6 10,24		ns
Turn-off delay time	$t_{d(off)}$					25 125 150		115,84 147,36 156,64		ns
Fall time	t_f					25 125 150		27,5 54,3 67,74		ns
Turn-on energy (per pulse)	E_{on}	$Q_{tFWD} = 0,155$ μC $Q_{tFWD} = 0,181$ μC $Q_{tFWD} = 0,181$ μC				25 125 150		0,826 0,93 0,956		mWs
Turn-off energy (per pulse)	E_{off}					25 125 150		1,69 2,67 3,01		mWs



Vincotech

Characteristic Values

Parameter	Symbol	Conditions					Values			Unit
		V_{GS} [V]	V_{GE} [V]	V_{DS} [V]	I_D [A]	T_j [°C]	Min	Typ	Max	

Outer Boost Switch

Static

Gate-emitter threshold voltage	$V_{GE(th)}$	$V_{CE} = V_{GE}$			0,00167	25	4,35	5,1	5,85	V
Collector-emitter saturation voltage	$V_{CE(sat)}$		15		100	25 125 150		1,67 1,94 2	2,35 ⁽¹⁾	V
Collector-emitter cut-off current	I_{CES}		0	950		25			2	μA
Gate-emitter leakage current	I_{GES}		20	0		25			100	nA
Internal gate resistance	r_g							1,5		Ω
Input capacitance	C_{ies}							6500		pF
Output capacitance	C_{oes}	$f = 100$ kHz	0	25		25		139		pF
Reverse transfer capacitance	C_{res}							20		pF
Gate charge	Q_g		15		0	25		230		nC

Thermal

Thermal resistance junction to sink ⁽²⁾	$R_{th(j-s)}$	$\lambda_{paste} = 3,4$ W/mK (PSX)						0,74		K/W
--	---------------	---------------------------------------	--	--	--	--	--	------	--	-----

Dynamic

Turn-on delay time	$t_{d(on)}$					25 125 150		92,64 94,24 94,72		ns
Rise time	t_r					25 125 150		8,32 9,6 10,24		ns
Turn-off delay time	$t_{d(off)}$					25 125 150		115,84 147,36 156,64		ns
Fall time	t_f					25 125 150		27,5 54,3 67,74		ns
Turn-on energy (per pulse)	E_{on}	$Q_{tFWD} = 0,155$ μC $Q_{tFWD} = 0,181$ μC $Q_{tFWD} = 0,181$ μC				25 125 150		0,826 0,93 0,956		mWs
Turn-off energy (per pulse)	E_{off}					25 125 150		1,69 2,67 3,01		mWs



Vincotech

10-FY10B2A100S7-LP26L06
datasheet

Characteristic Values

Parameter	Symbol	Conditions					Values			Unit
		V_{GE} [V] V_{GS} [V]	V_{CE} [V] V_{DS} [V] V_F [V]	I_C [A] I_D [A] I_F [A]	T_j [°C]	Min	Typ	Max		
Inner Boost Diode										
Static										
Forward voltage	V_F				30	25 125 150		1,51 2,03 2,13	1,8 ⁽¹⁾	V
Reverse leakage current	I_R	$V_T = 1200$ V				25		90	750	μA
Thermal										
Thermal resistance junction to sink ⁽²⁾	$R_{th(j-s)}$	$\lambda_{paste} = 3,4$ W/mK (PSX)						0,9		K/W
Dynamic										
Peak recovery current	I_{RRM}					25 125 150		31,16 30,08 29,75		A
Reverse recovery time	t_{rr}					25 125 150		9,68 10,47 10,5		ns
Recovered charge	Q_r	$di/dt=7063$ A/μs $di/dt=6671$ A/μs $di/dt=6376$ A/μs	±15	600	65	25 125 150		0,155 0,181 0,181		μC
Reverse recovered energy	E_{rec}					25 125 150		0,063 0,073 0,072		mWs
Peak rate of fall of recovery current	$(di_r/dt)_{max}$					25 125 150		9797 7873 7557		A/μs



Vincotech

10-FY10B2A100S7-LP26L06
datasheet

Characteristic Values

Parameter	Symbol	Conditions					Values			Unit
		V_{GE} [V] V_{GS} [V]	V_{CE} [V] V_{DS} [V] V_F [V]	I_C [A] I_D [A] I_F [A]	T_j [°C]	Min	Typ	Max		
Outer Boost Diode										
Static										
Forward voltage	V_F				30	25 125 150		1,51 2,03 2,13	1,8 ⁽¹⁾	V
Reverse leakage current	I_R	$V_T = 1200$ V				25		90	750	μA
Thermal										
Thermal resistance junction to sink ⁽²⁾	$R_{th(j-s)}$	$\lambda_{paste} = 3,4$ W/mK (PSX)						0,9		K/W
Dynamic										
Peak recovery current	I_{RRM}					25 125 150		31,16 30,08 29,75		A
Reverse recovery time	t_{rr}					25 125 150		9,68 10,47 10,5		ns
Recovered charge	Q_r	$di/dt=7063$ A/μs $di/dt=6671$ A/μs $di/dt=6376$ A/μs	±15	600	65	25 125 150		0,155 0,181 0,181		μC
Reverse recovered energy	E_{rec}					25 125 150		0,063 0,073 0,072		mWs
Peak rate of fall of recovery current	$(di_r/dt)_{max}$					25 125 150		9797 7873 7557		A/μs



Vincotech

Characteristic Values

Parameter	Symbol	Conditions					Values			Unit
		V_{GE} [V] V_{GS} [V]	V_{CE} [V] V_{DS} [V] V_F [V]	I_C [A] I_D [A] I_F [A]	T_j [°C]	Min	Typ	Max		

Inner Boost Sw. Protection Diode

Static

Forward voltage	V_F				35	25 125 150		1,66 1,76 1,74	2,1 ⁽¹⁾	V
Reverse leakage current	I_R	$V_i = 1200$ V				25			40	μA

Thermal

Thermal resistance junction to sink ⁽²⁾	$R_{th(j-s)}$	$\lambda_{paste} = 3,4$ W/mK (PSX)						1,27		K/W
--	---------------	------------------------------------	--	--	--	--	--	------	--	-----

Outer Boost Sw. Protection Diode

Static

Forward voltage	V_F				35	25 125 150		1,66 1,76 1,74	2,1 ⁽¹⁾	V
Reverse leakage current	I_R	$V_i = 1200$ V				25			40	μA

Thermal

Thermal resistance junction to sink ⁽²⁾	$R_{th(j-s)}$	$\lambda_{paste} = 3,4$ W/mK (PSX)						1,27		K/W
--	---------------	------------------------------------	--	--	--	--	--	------	--	-----

Flying Capacitor

Static

Capacitance	C	DC bias voltage = 0 V				25		47		nF
Tolerance							-10		10	%



Vincotech

Characteristic Values

Parameter	Symbol	Conditions						Values			Unit
		V_{GE} [V]	V_{GS} [V]	V_{CE} [V]	V_{DS} [V]	I_C [A]	I_D [A]	T_j [°C]	Min	Typ	

Capacitor (DC)

Static

Capacitance	C	DC bias voltage = 0 V				25		33		nF
Tolerance							-10		10	%
Dissipation factor		$f = 1$ kHz				25		2,5		%

Thermistor

Static

Rated resistance	R					25		22		k Ω
Deviation of R_{100}	$A_{R/R}$	$R_{100} = 1484 \Omega$				100	-5		5	%
Power dissipation	P							5		mW
Power dissipation constant	d					25		1,5		mW/K
B-value	$B_{(25/50)}$	Tol. ± 1 %						3962		K
B-value	$B_{(25/100)}$	Tol. ± 1 %						4000		K
Vincotech Thermistor Reference									I	

(1) Value at chip level

(2) Only valid with pre-applied Vincotech thermal interface material.



Inner Boost Switch Characteristics

figure 1. IGBT

Typical output characteristics

$$I_C = f(V_{CE})$$

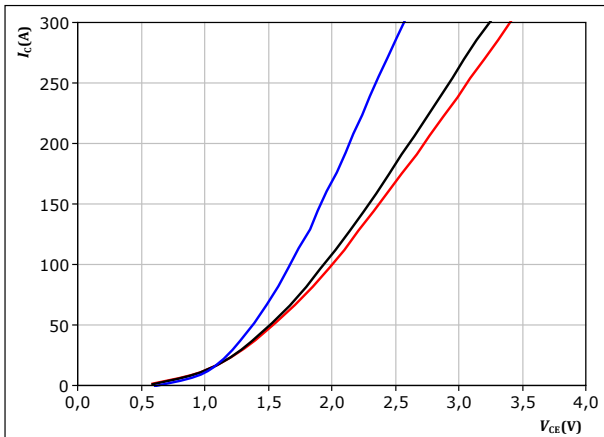

$t_p = 250 \mu s$
 $V_{GE} = 15 V$
 $T_j:$ 25 °C (blue), 125 °C (black), 150 °C (red)

figure 2. IGBT

Typical output characteristics

$$I_C = f(V_{CE})$$

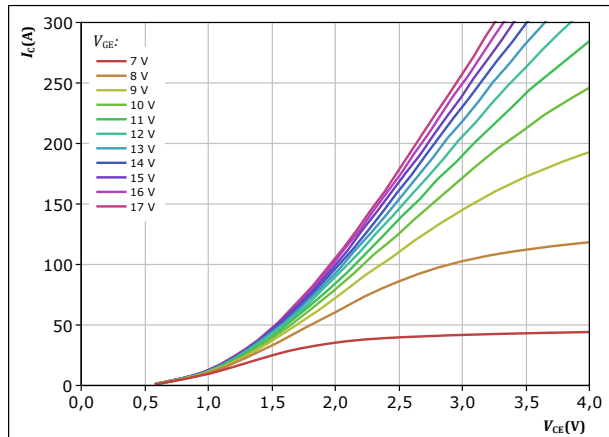

$t_p = 250 \mu s$
 $T_j = 150 \text{ °C}$
 V_{GE} from 7 V to 17 V in steps of 1 V

figure 3. IGBT

Typical transfer characteristics

$$I_C = f(V_{GE})$$

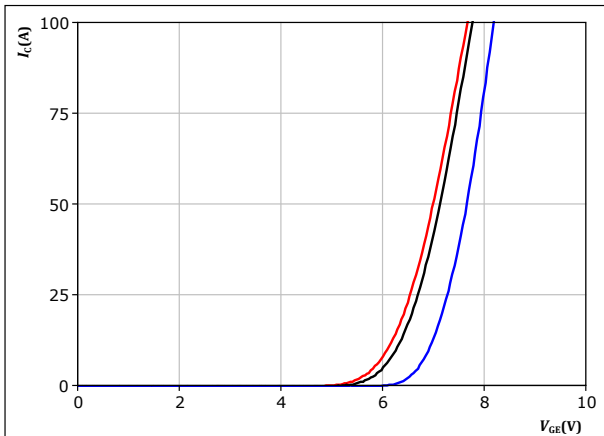

$t_p = 250 \mu s$
 $V_{CE} = 10 V$
 $T_j:$ 25 °C (blue), 125 °C (black), 150 °C (red)

figure 4. IGBT

Transient thermal impedance as a function of pulse width

$$Z_{th(j-s)} = f(t_p)$$

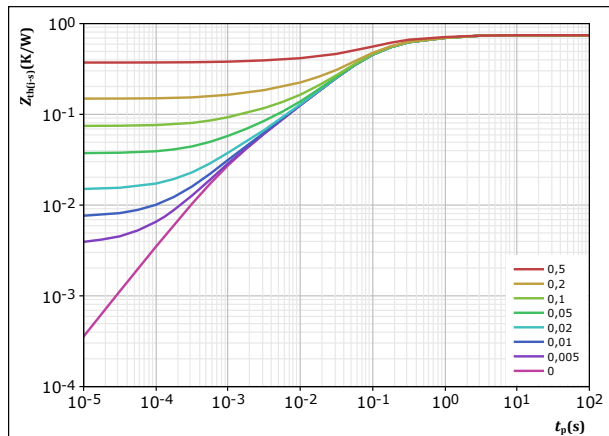

$D = t_p / T$
 $R_{th(j-s)} = 0,744 \text{ K/W}$
 IGBT thermal model values

R (K/W)	τ (s)
1,10E-01	1,21E+00
2,70E-01	1,55E-01
2,88E-01	5,60E-02
5,30E-02	8,10E-03
2,36E-02	1,06E-03



Inner Boost Switch Characteristics

figure 5. IGBT

Safe operating area

$$I_C = f(V_{CE})$$

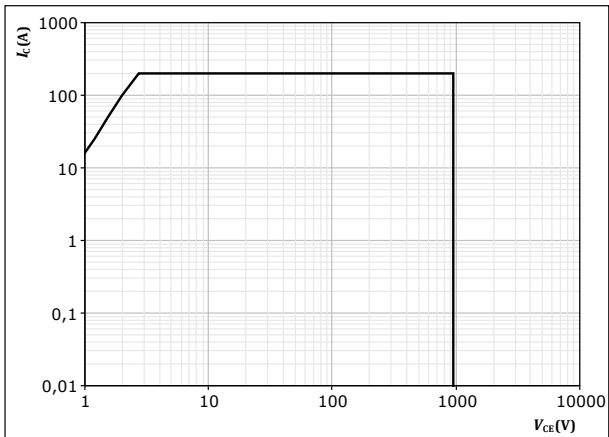

$D = \text{single pulse}$
 $T_s = 80 \text{ } ^\circ\text{C}$
 $V_{CE} = 15 \text{ V}$
 $T_j = T_{jmax}$



Outer Boost Switch Characteristics

figure 6. IGBT

Typical output characteristics

$$I_C = f(V_{CE})$$

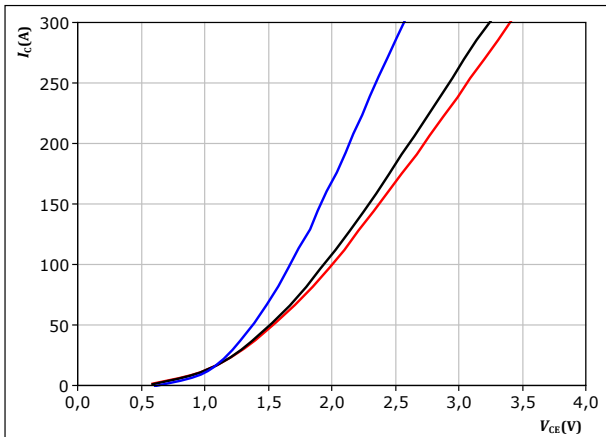

$t_p = 250 \mu s$
 $V_{GE} = 15 V$

T_j : 25 °C (blue), 125 °C (black), 150 °C (red)

figure 7. IGBT

Typical output characteristics

$$I_C = f(V_{CE})$$

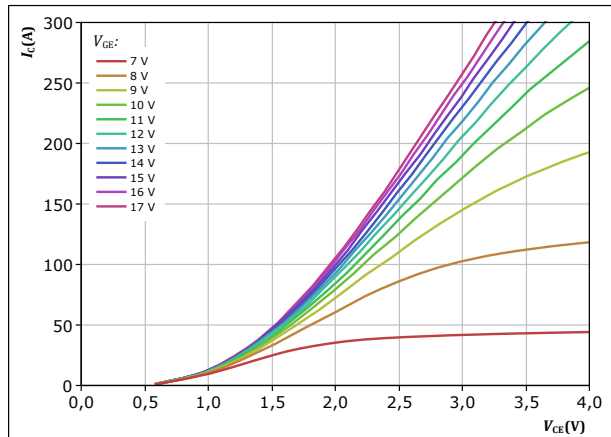

$t_p = 250 \mu s$
 $T_j = 150 \text{ °C}$
 V_{GE} from 7 V to 17 V in steps of 1 V

figure 8. IGBT

Typical transfer characteristics

$$I_C = f(V_{GE})$$

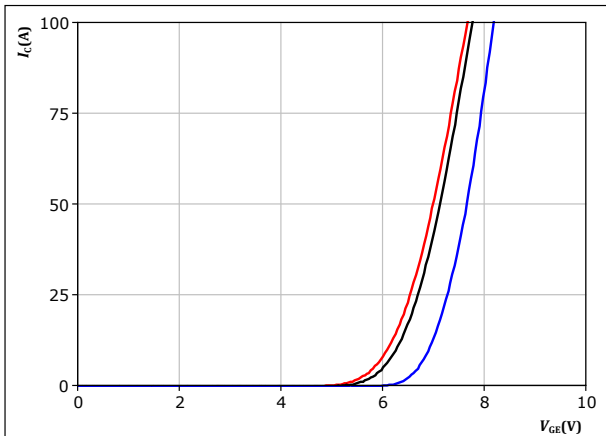

$t_p = 250 \mu s$
 $V_{CE} = 10 V$

T_j : 25 °C (blue), 125 °C (black), 150 °C (red)

figure 9. IGBT

Transient thermal impedance as a function of pulse width

$$Z_{th(j-s)} = f(t_p)$$

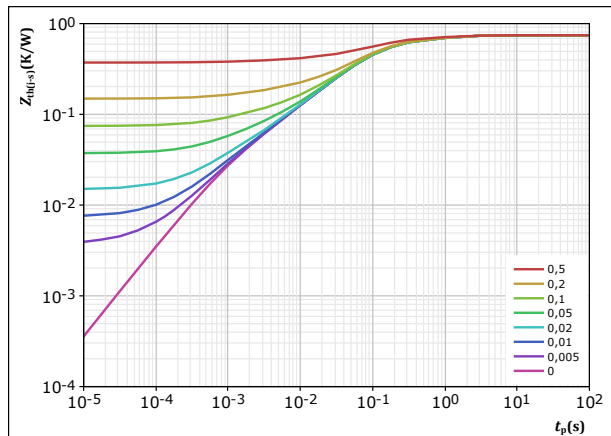

$D = t_p / T$
 $R_{th(j-s)} = 0,744 \text{ K/W}$

IGBT thermal model values

R (K/W)	τ (s)
1,10E-01	1,21E+00
2,70E-01	1,55E-01
2,88E-01	5,60E-02
5,30E-02	8,10E-03
2,36E-02	1,06E-03



Outer Boost Switch Characteristics

figure 10. IGBT

Safe operating area

$$I_C = f(V_{CE})$$

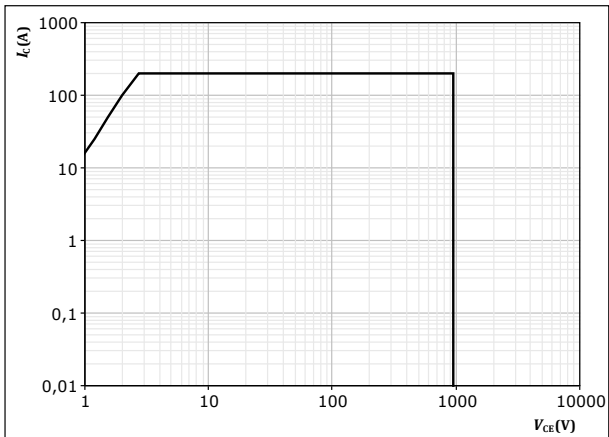

D = single pulse
T_s = 80 °C
V_{CE} = 15 V
T_j = T_{jmax}



Inner Boost Diode Characteristics

figure 11. FWD

Typical forward characteristics

$$I_F = f(V_F)$$

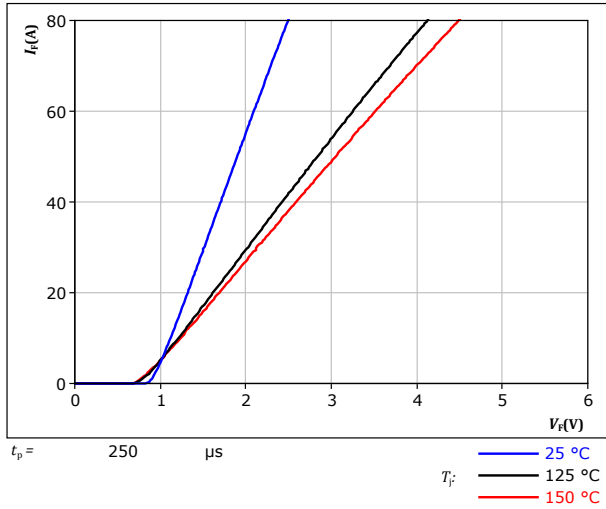
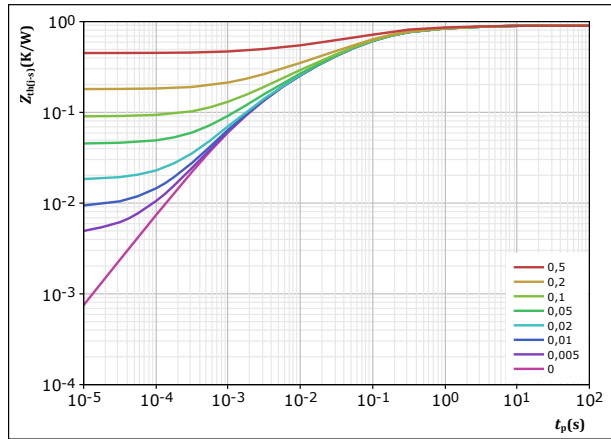

figure 12. FWD

Transient thermal impedance as a function of pulse width

$$Z_{th(j-s)} = f(t_p)$$



$D =$	t_p / T
$R_{th(j-s)} =$	0,901 K/W
FWD thermal model values	
R (K/W)	τ (s)
6,65E-02	3,02E+00
1,53E-01	3,98E-01
4,06E-01	7,42E-02
2,08E-01	9,81E-03
6,71E-02	1,40E-03



Outer Boost Diode Characteristics

figure 13. FWD

Typical forward characteristics

$$I_F = f(V_F)$$

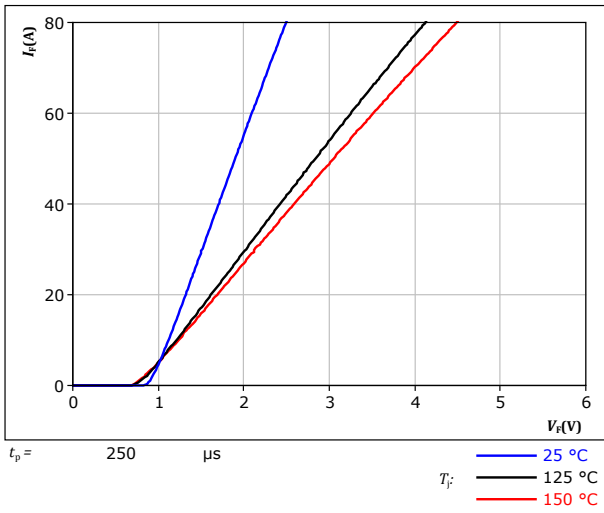
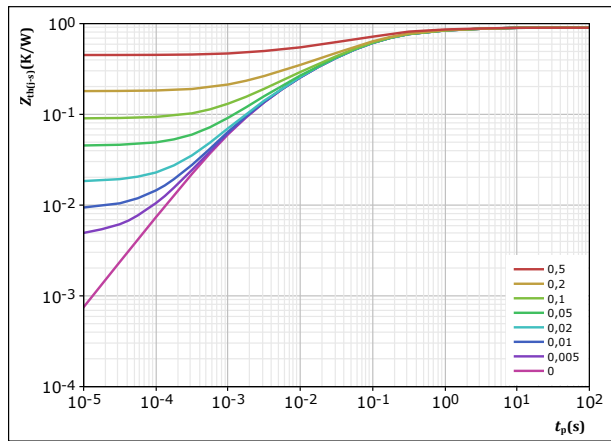

figure 14. FWD

Transient thermal impedance as a function of pulse width

$$Z_{th(j-s)} = f(t_p)$$





Inner Boost Sw. Protection Diode Characteristics

figure 15. FWD

Typical forward characteristics

$$I_F = f(V_F)$$

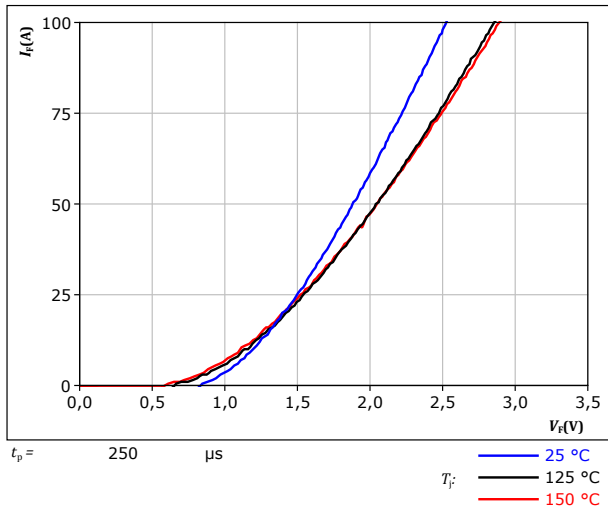
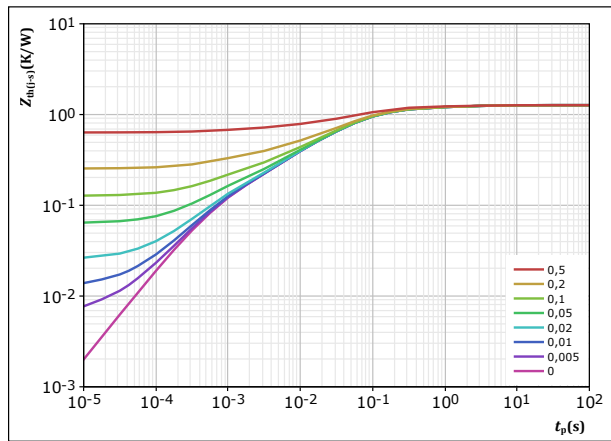

figure 16. FWD

Transient thermal impedance as a function of pulse width

$$Z_{th(j-s)} = f(t_p)$$



$D = t_p / T$
 $R_{th(j-s)} = 1,269$ K/W
 FWD thermal model values

R (K/W)	τ (s)
5,82E-02	3,40E+00
1,11E-01	5,24E-01
4,63E-01	9,20E-02
3,72E-01	2,94E-02
1,72E-01	5,46E-03
9,36E-02	6,17E-04



Outer Boost Sw. Protection Diode Characteristics

figure 17. FWD

Typical forward characteristics

$$I_F = f(V_F)$$

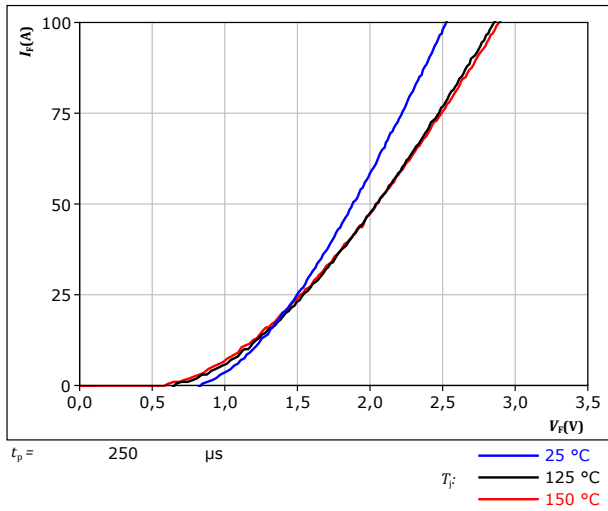
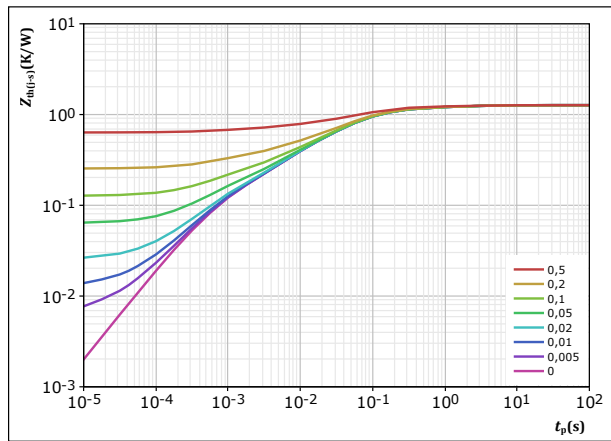

figure 18. FWD

Transient thermal impedance as a function of pulse width

$$Z_{th(j-s)} = f(t_p)$$



$D = t_p / T$
 $R_{th(j-s)} = 1,269 \text{ K/W}$
 FWD thermal model values

R (K/W)	τ (s)
5,82E-02	3,40E+00
1,11E-01	5,24E-01
4,63E-01	9,20E-02
3,72E-01	2,94E-02
1,72E-01	5,46E-03
9,36E-02	6,17E-04



Thermistor Characteristics

figure 19. Thermistor

Typical NTC characteristic as function of temperature
 $R_T = f(T)$

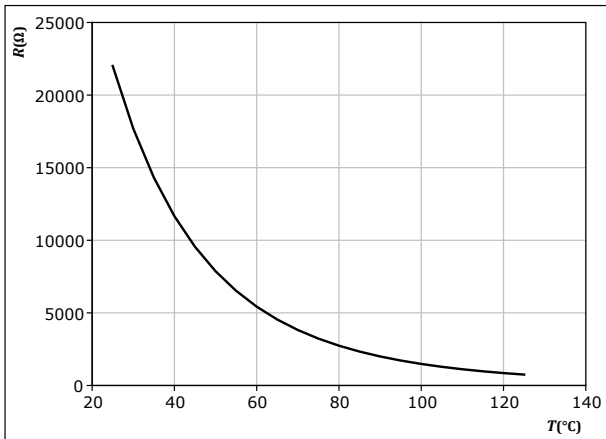



Inner Boost Switching Characteristics

figure 20. IGBT

Typical switching energy losses as a function of collector current
 $E = f(I_c)$

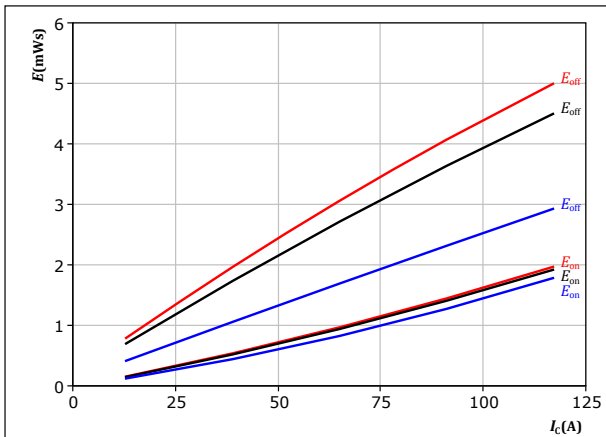

With an inductive load at
 $V_{CE} = 600 \text{ V}$
 $V_{GE} = \pm 15 \text{ V}$
 $R_{gon} = 4 \ \Omega$
 $R_{goff} = 4 \ \Omega$
 T_j : 25 °C (blue), 125 °C (black), 150 °C (red)

figure 21. IGBT

Typical switching energy losses as a function of gate resistor
 $E = f(R_g)$

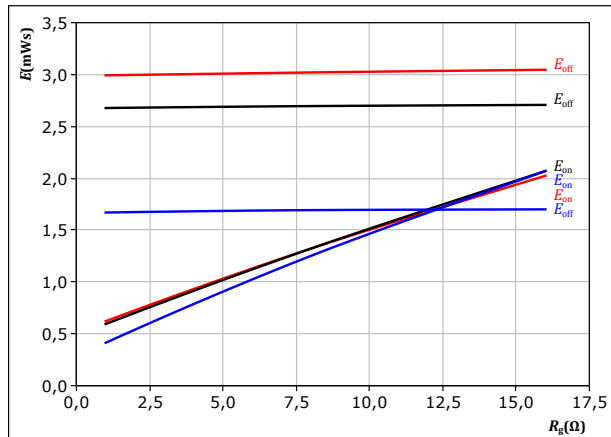

With an inductive load at
 $V_{CE} = 600 \text{ V}$
 $V_{GE} = \pm 15 \text{ V}$
 $I_c = 65 \text{ A}$
 T_j : 25 °C (blue), 125 °C (black), 150 °C (red)

figure 22. FWD

Typical reverse recovered energy loss as a function of collector current
 $E_{rec} = f(I_c)$

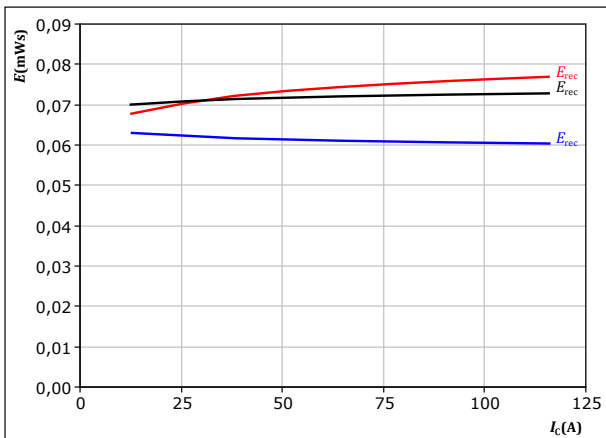

With an inductive load at
 $V_{CE} = 600 \text{ V}$
 $V_{GE} = \pm 15 \text{ V}$
 $R_{gon} = 4 \ \Omega$
 T_j : 25 °C (blue), 125 °C (black), 150 °C (red)

figure 23. FWD

Typical reverse recovered energy loss as a function of gate resistor
 $E_{rec} = f(R_g)$

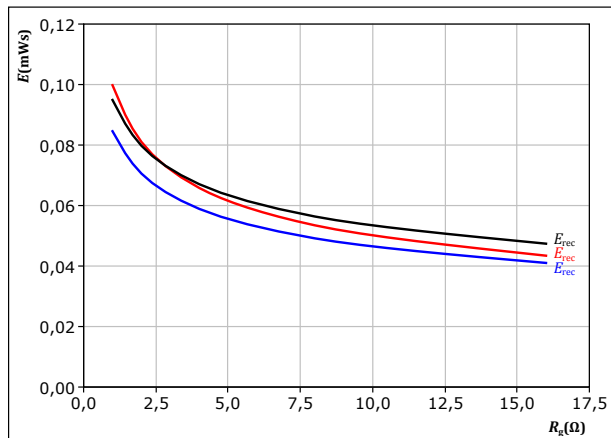

With an inductive load at
 $V_{CE} = 600 \text{ V}$
 $V_{GE} = \pm 15 \text{ V}$
 $I_c = 65 \text{ A}$
 T_j : 25 °C (blue), 125 °C (black), 150 °C (red)



Inner Boost Switching Characteristics

figure 24. IGBT

Typical switching times as a function of collector current
 $t = f(I_c)$

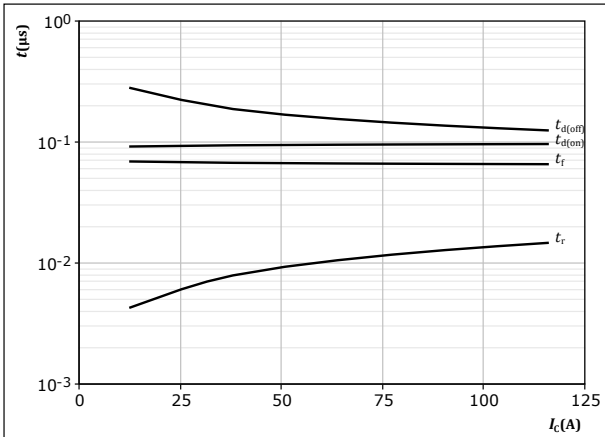

With an inductive load at
 $T_j = 150 \text{ }^\circ\text{C}$
 $V_{CE} = 600 \text{ V}$
 $V_{GE} = \pm 15 \text{ V}$
 $R_{gon} = 4 \text{ } \Omega$
 $R_{goff} = 4 \text{ } \Omega$

figure 25. IGBT

Typical switching times as a function of gate resistor
 $t = f(R_g)$

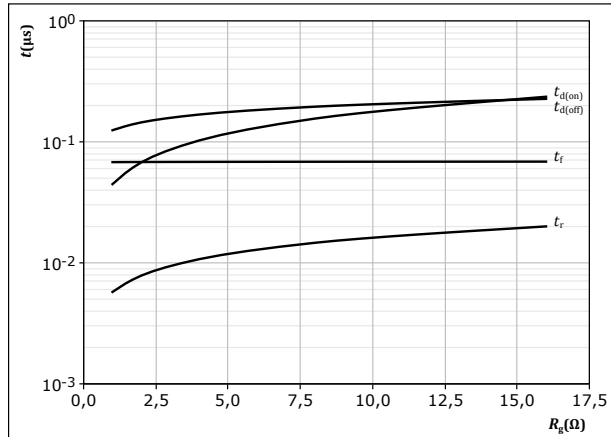

With an inductive load at
 $T_j = 150 \text{ }^\circ\text{C}$
 $V_{CE} = 600 \text{ V}$
 $V_{GE} = \pm 15 \text{ V}$
 $I_c = 65 \text{ A}$

figure 26. FWD

Typical reverse recovery time as a function of collector current
 $t_{rr} = f(I_c)$

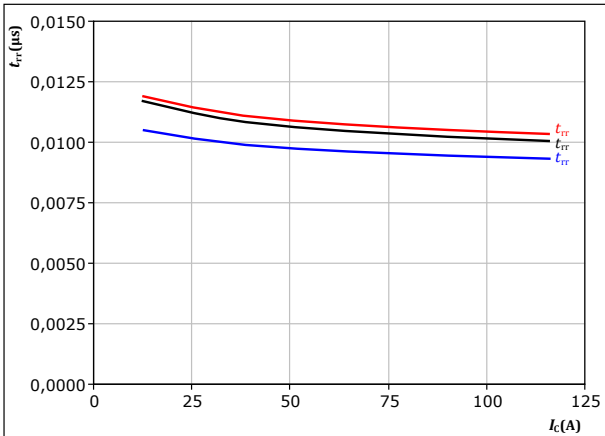

With an inductive load at
 $V_{CE} = 600 \text{ V}$
 $V_{GE} = \pm 15 \text{ V}$
 $R_{gon} = 4 \text{ } \Omega$
 $T_j: \text{ } \text{---} 25 \text{ }^\circ\text{C}$
 $\text{---} 125 \text{ }^\circ\text{C}$
 $\text{---} 150 \text{ }^\circ\text{C}$

figure 27. FWD

Typical reverse recovery time as a function of IGBT turn on gate resistor
 $t_{rr} = f(R_{gon})$

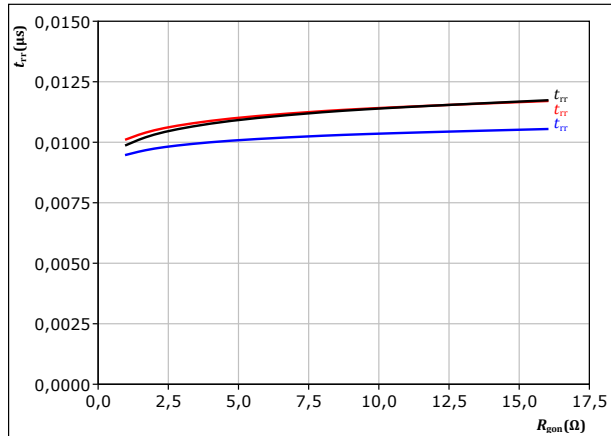

With an inductive load at
 $V_{CE} = 600 \text{ V}$
 $V_{GE} = \pm 15 \text{ V}$
 $I_c = 65 \text{ A}$
 $T_j: \text{ } \text{---} 25 \text{ }^\circ\text{C}$
 $\text{---} 125 \text{ }^\circ\text{C}$
 $\text{---} 150 \text{ }^\circ\text{C}$



Inner Boost Switching Characteristics

figure 28. FWD

Typical recovered charge as a function of collector current

$$Q_r = f(I_c)$$

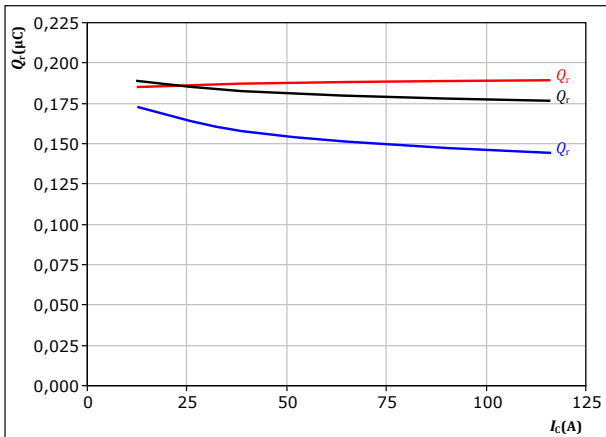

With an inductive load at

$V_{CE} = 600 \text{ V}$
 $V_{GE} = \pm 15 \text{ V}$
 $R_{gon} = 4 \ \Omega$

T_j : — 25 °C
— 125 °C
— 150 °C

figure 29. FWD

Typical recovered charge as a function of turn on gate resistor

$$Q_r = f(R_{gon})$$

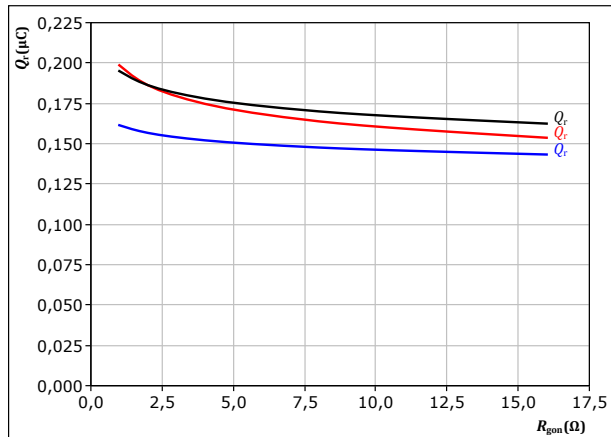

With an inductive load at

$V_{CE} = 600 \text{ V}$
 $V_{GE} = \pm 15 \text{ V}$
 $I_c = 65 \text{ A}$

T_j : — 25 °C
— 125 °C
— 150 °C

figure 30. FWD

Typical peak reverse recovery current as a function of collector current

$$I_{RM} = f(I_c)$$

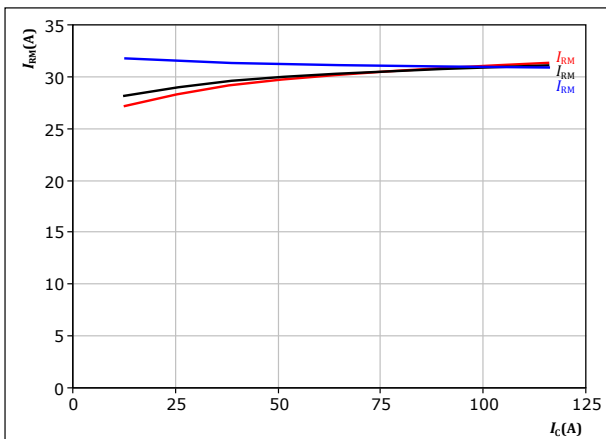

With an inductive load at

$V_{CE} = 600 \text{ V}$
 $V_{GE} = \pm 15 \text{ V}$
 $R_{gon} = 4 \ \Omega$

T_j : — 25 °C
— 125 °C
— 150 °C

figure 31. FWD

Typical peak reverse recovery current as a function of turn on gate resistor

$$I_{RM} = f(R_{gon})$$

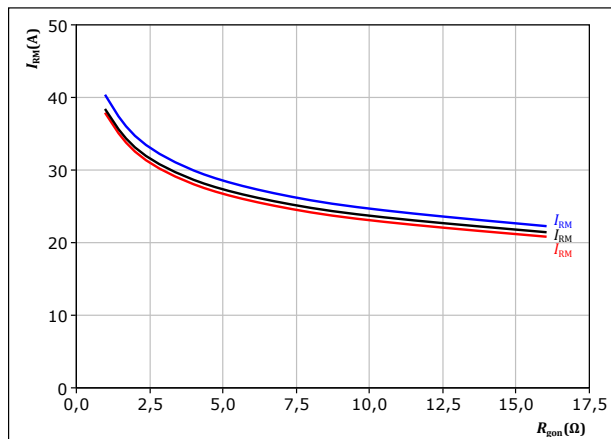

With an inductive load at

$V_{CE} = 600 \text{ V}$
 $V_{GE} = \pm 15 \text{ V}$
 $I_c = 65 \text{ A}$

T_j : — 25 °C
— 125 °C
— 150 °C



Inner Boost Switching Characteristics

figure 32. FWD

Typical rate of fall of forward and reverse recovery current as a function of collector current
 $di_f/dt, di_{rr}/dt = f(I_C)$

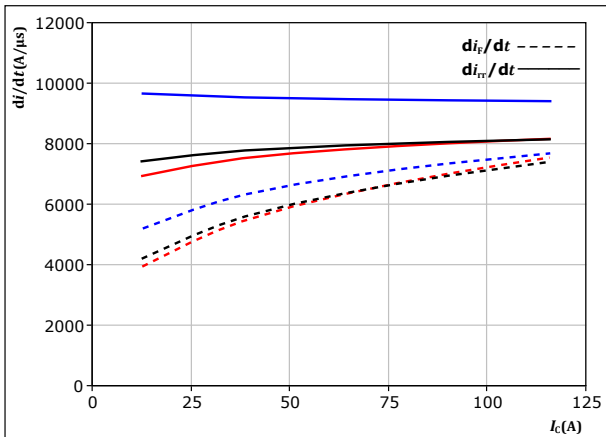

With an inductive load at
 $V_{CE} = 600 \text{ V}$
 $V_{GE} = \pm 15 \text{ V}$
 $R_{gon} = 4 \ \Omega$

T_j :
— 25 °C
— 125 °C
— 150 °C

figure 33. FWD

Typical rate of fall of forward and reverse recovery current as a function of turn on gate resistor
 $di_f/dt, di_{rr}/dt = f(R_{gon})$

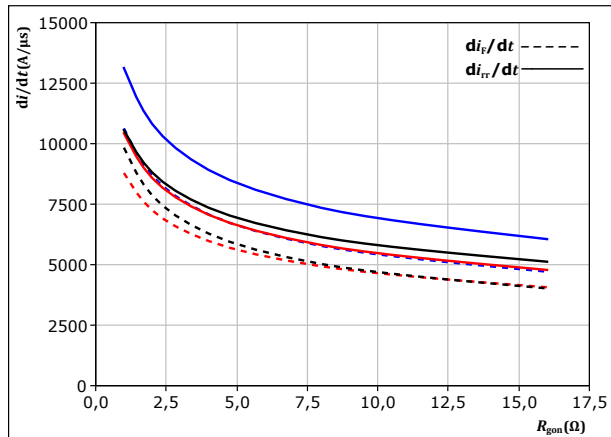

With an inductive load at
 $V_{CE} = 600 \text{ V}$
 $V_{GE} = \pm 15 \text{ V}$
 $I_C = 65 \text{ A}$

T_j :
— 25 °C
— 125 °C
— 150 °C

figure 34. IGBT

Reverse bias safe operating area
 $I_C = f(V_{CE})$

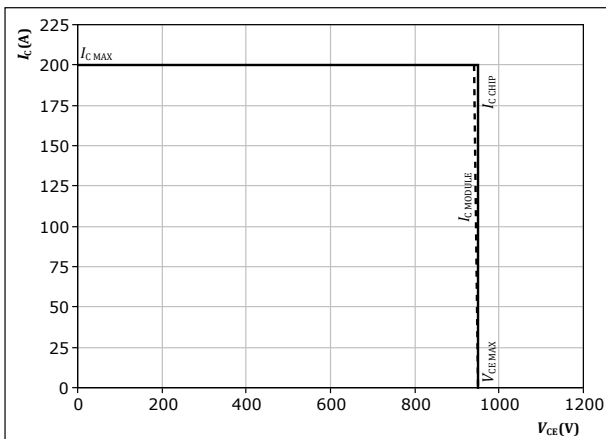

At $T_j = 150 \text{ °C}$
 $R_{gon} = 4 \ \Omega$
 $R_{goff} = 4 \ \Omega$



Outer Boost Switching Characteristics

figure 35. IGBT

Typical switching energy losses as a function of collector current
 $E = f(I_c)$

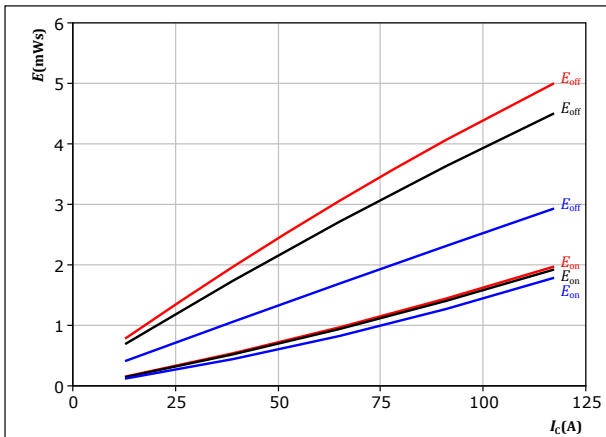

With an inductive load at
 $V_{CE} = 600 \text{ V}$
 $V_{GE} = \pm 15 \text{ V}$
 $R_{gon} = 4 \ \Omega$
 $R_{goff} = 4 \ \Omega$

T_j : — 25 °C
 — 125 °C
 — 150 °C

figure 36. IGBT

Typical switching energy losses as a function of gate resistor
 $E = f(R_g)$

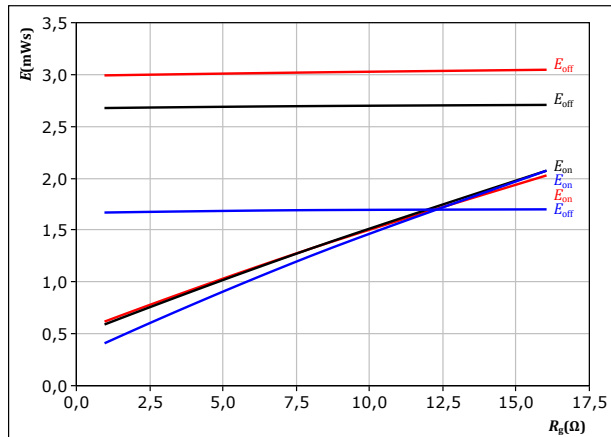

With an inductive load at
 $V_{CE} = 600 \text{ V}$
 $V_{GE} = \pm 15 \text{ V}$
 $I_c = 65 \text{ A}$

T_j : — 25 °C
 — 125 °C
 — 150 °C

figure 37. FWD

Typical reverse recovered energy loss as a function of collector current
 $E_{rec} = f(I_c)$

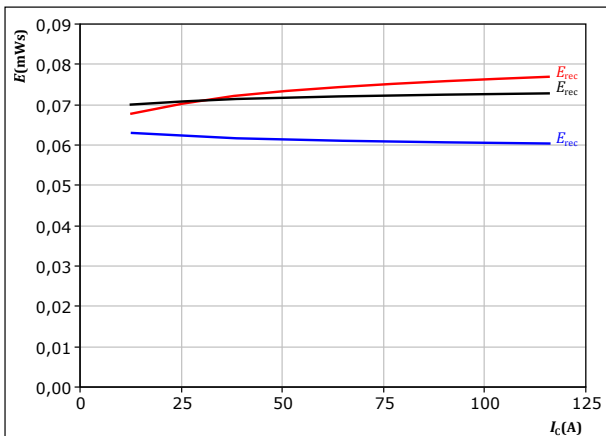

With an inductive load at
 $V_{CE} = 600 \text{ V}$
 $V_{GE} = \pm 15 \text{ V}$
 $R_{gon} = 4 \ \Omega$

T_j : — 25 °C
 — 125 °C
 — 150 °C

figure 38. FWD

Typical reverse recovered energy loss as a function of gate resistor
 $E_{rec} = f(R_g)$

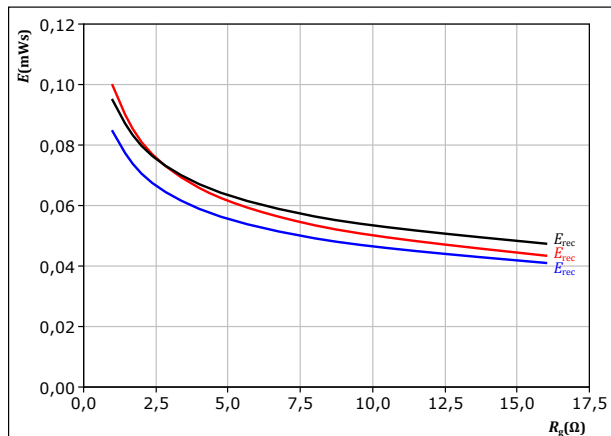

With an inductive load at
 $V_{CE} = 600 \text{ V}$
 $V_{GE} = \pm 15 \text{ V}$
 $I_c = 65 \text{ A}$

T_j : — 25 °C
 — 125 °C
 — 150 °C



Outer Boost Switching Characteristics

figure 39. IGBT

Typical switching times as a function of collector current
 $t = f(I_c)$

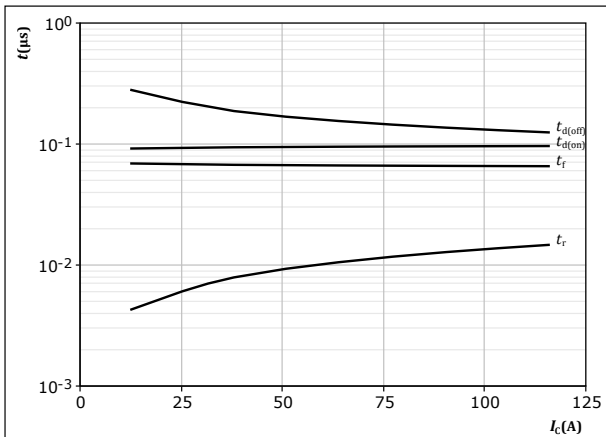

With an inductive load at
 $T_j = 150 \text{ }^\circ\text{C}$
 $V_{CE} = 600 \text{ V}$
 $V_{GE} = \pm 15 \text{ V}$
 $R_{gon} = 4 \text{ } \Omega$
 $R_{goff} = 4 \text{ } \Omega$

figure 40. IGBT

Typical switching times as a function of gate resistor
 $t = f(R_g)$

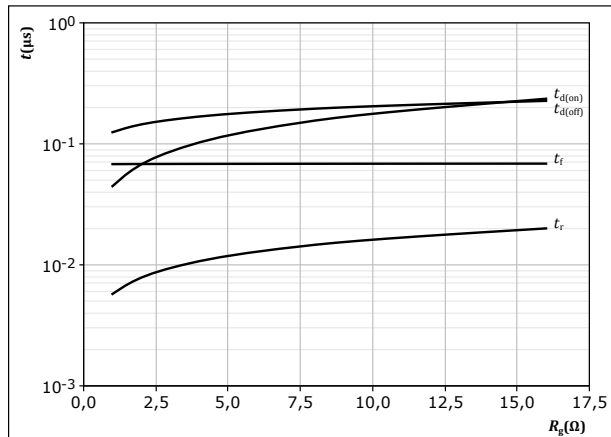

With an inductive load at
 $T_j = 150 \text{ }^\circ\text{C}$
 $V_{CE} = 600 \text{ V}$
 $V_{GE} = \pm 15 \text{ V}$
 $I_c = 65 \text{ A}$

figure 41. FWD

Typical reverse recovery time as a function of collector current
 $t_{rr} = f(I_c)$

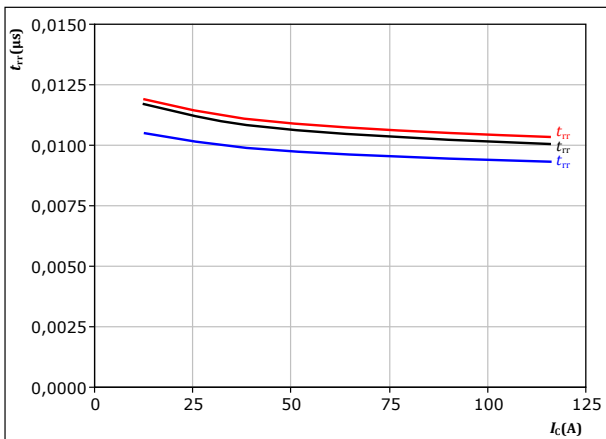

With an inductive load at
 $V_{CE} = 600 \text{ V}$
 $V_{GE} = \pm 15 \text{ V}$
 $R_{gon} = 4 \text{ } \Omega$
 $T_j: \text{ — } 25 \text{ }^\circ\text{C}$
 $\text{ — } 125 \text{ }^\circ\text{C}$
 $\text{ — } 150 \text{ }^\circ\text{C}$

figure 42. FWD

Typical reverse recovery time as a function of IGBT turn on gate resistor
 $t_{rr} = f(R_{gon})$

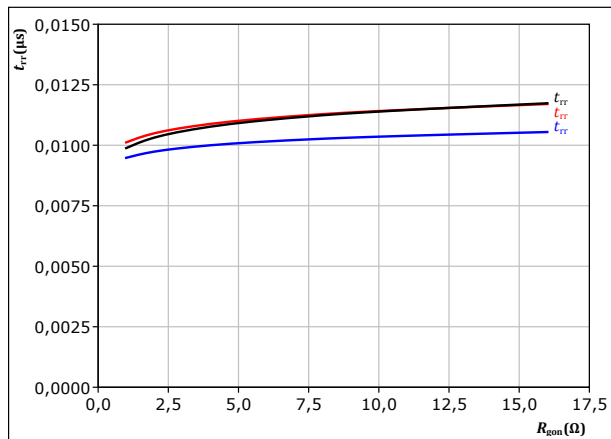

With an inductive load at
 $V_{CE} = 600 \text{ V}$
 $V_{GE} = \pm 15 \text{ V}$
 $I_c = 65 \text{ A}$
 $T_j: \text{ — } 25 \text{ }^\circ\text{C}$
 $\text{ — } 125 \text{ }^\circ\text{C}$
 $\text{ — } 150 \text{ }^\circ\text{C}$



Outer Boost Switching Characteristics

figure 43. FWD

Typical recovered charge as a function of collector current

$$Q_r = f(I_c)$$

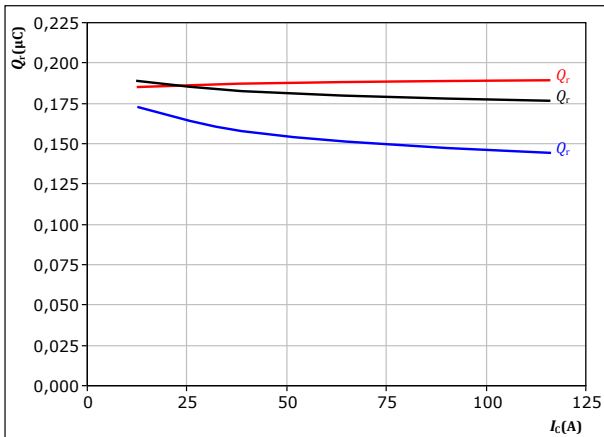

With an inductive load at

$V_{CE} = 600$ V
 $V_{GE} = \pm 15$ V
 $R_{gon} = 4$ Ω

T_j : — 25 °C
— 125 °C
— 150 °C

figure 44. FWD

Typical recovered charge as a function of turn on gate resistor

$$Q_r = f(R_{gon})$$

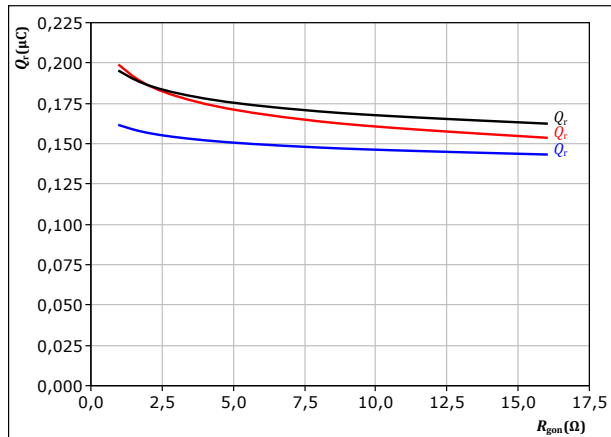

With an inductive load at

$V_{CE} = 600$ V
 $V_{GE} = \pm 15$ V
 $I_c = 65$ A

T_j : — 25 °C
— 125 °C
— 150 °C

figure 45. FWD

Typical peak reverse recovery current as a function of collector current

$$I_{RM} = f(I_c)$$

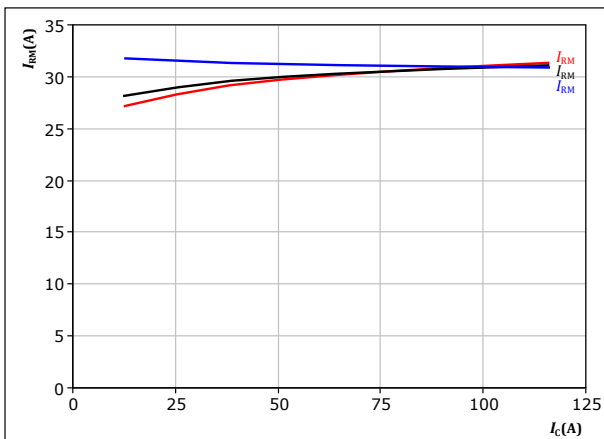

With an inductive load at

$V_{CE} = 600$ V
 $V_{GE} = \pm 15$ V
 $R_{gon} = 4$ Ω

T_j : — 25 °C
— 125 °C
— 150 °C

figure 46. FWD

Typical peak reverse recovery current as a function of turn on gate resistor

$$I_{RM} = f(R_{gon})$$

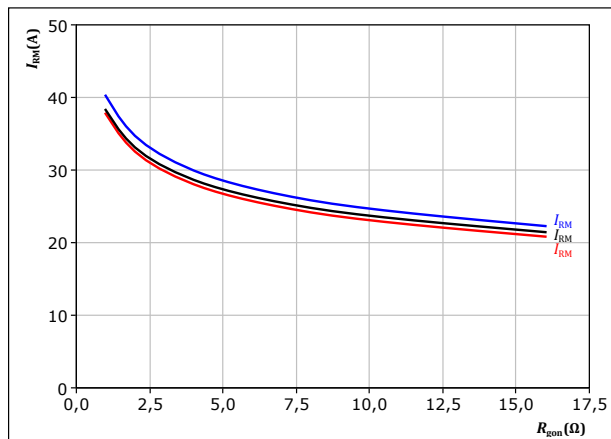

With an inductive load at

$V_{CE} = 600$ V
 $V_{GE} = \pm 15$ V
 $I_c = 65$ A

T_j : — 25 °C
— 125 °C
— 150 °C



Outer Boost Switching Characteristics

figure 47. FWD

Typical rate of fall of forward and reverse recovery current as a function of collector current
 $di_f/dt, di_r/dt = f(I_C)$

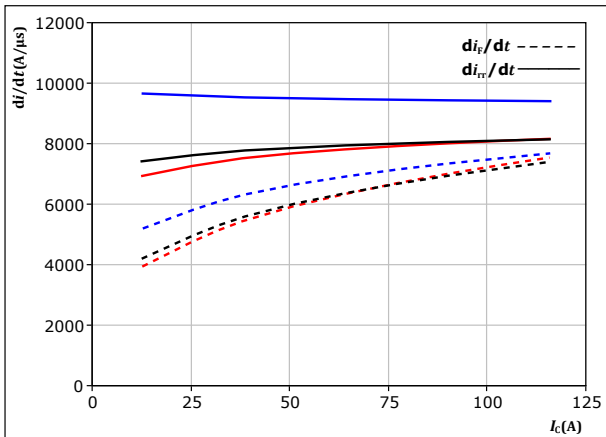

With an inductive load at
 $V_{CE} = 600 \text{ V}$
 $V_{GE} = \pm 15 \text{ V}$
 $R_{gon} = 4 \text{ } \Omega$

T_f :
— 25 °C
— 125 °C
— 150 °C

figure 48. FWD

Typical rate of fall of forward and reverse recovery current as a function of turn on gate resistor
 $di_f/dt, di_r/dt = f(R_{gon})$

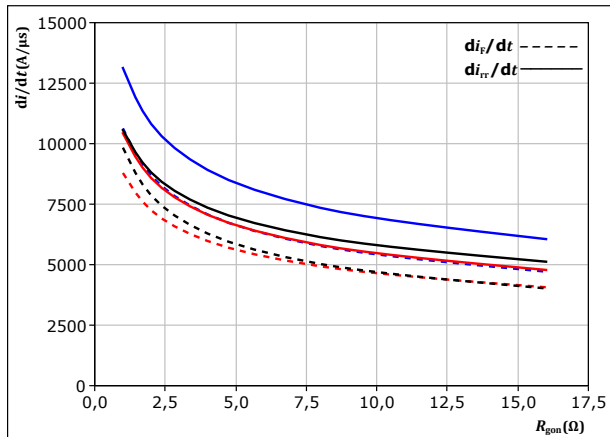

With an inductive load at
 $V_{CE} = 600 \text{ V}$
 $V_{GE} = \pm 15 \text{ V}$
 $I_C = 65 \text{ A}$

T_f :
— 25 °C
— 125 °C
— 150 °C

figure 49. IGBT

Reverse bias safe operating area
 $I_C = f(V_{CE})$

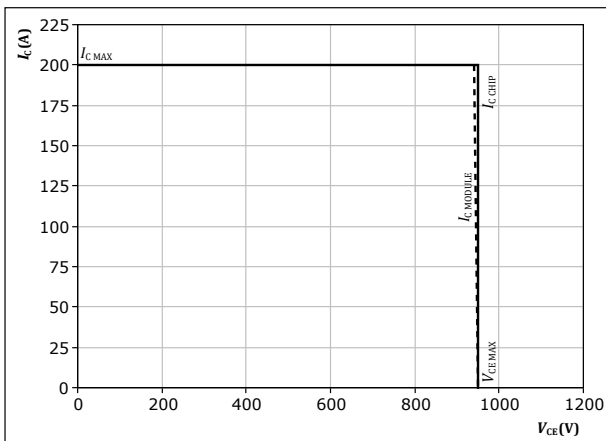

At $T_f = 150 \text{ } ^\circ\text{C}$
 $R_{gon} = 4 \text{ } \Omega$
 $R_{goff} = 4 \text{ } \Omega$



Switching Definitions

figure 50. IGBT
Turn-off Switching Waveforms & definition of t_{doff} , t_{Eoff} (t_{Eoff} = integrating time for E_{off})

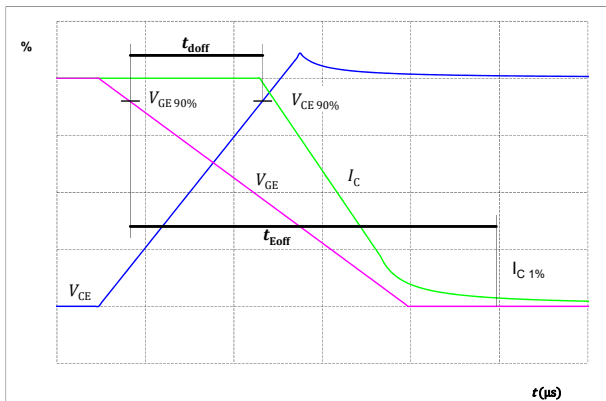

figure 51. IGBT
Turn-on Switching Waveforms & definition of t_{don} , t_{Eon} (t_{Eon} = integrating time for E_{on})

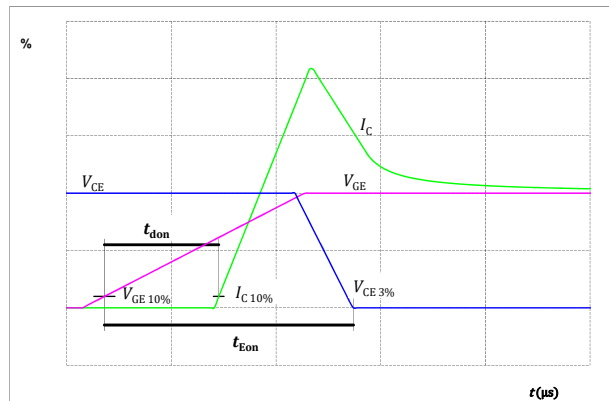

figure 52. IGBT
Turn-off Switching Waveforms & definition of t_f

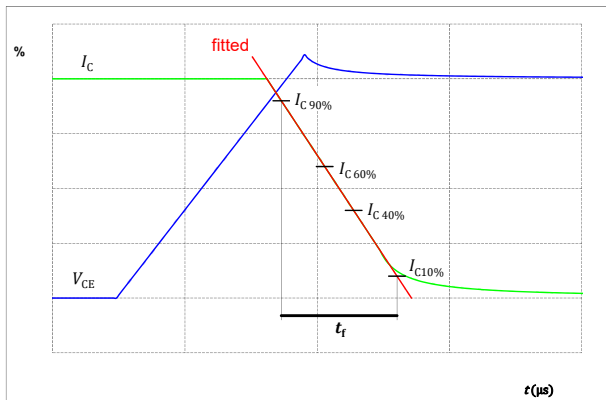
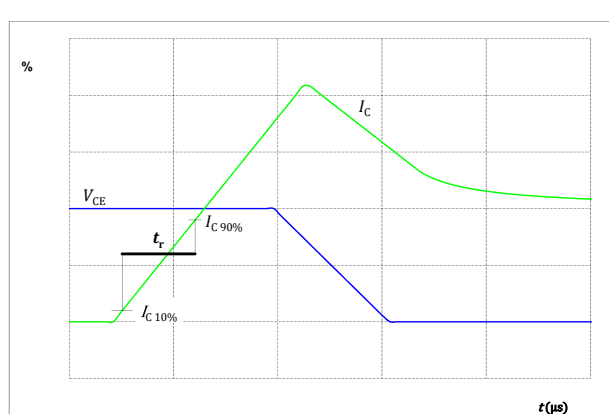

figure 53. IGBT
Turn-on Switching Waveforms & definition of t_r





Switching Definitions

figure 54. FWD

Turn-off Switching Waveforms & definition of t_{rr}

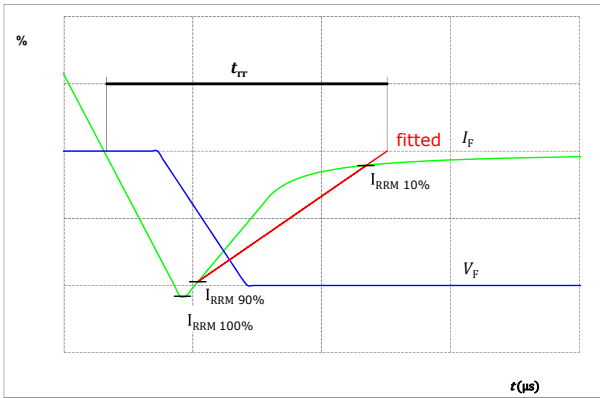
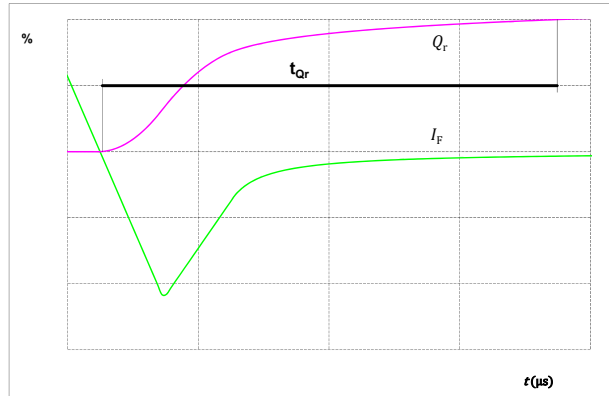

figure 55. FWD

Turn-on Switching Waveforms & definition of t_{Qr} (t_{Qr} = integrating time for Q_r)





Vincotech

Ordering Code	
Version	Ordering Code
Without thermal paste	10-FY10B2A100S7-LP26L06
With thermal paste	10-FY10B2A100S7-LP26L06-/3/

Marking						
	Text	Name NN-NNNNNNNNNNNNNN- TTTTTV	Date code WWYY	UL & VIN UL VIN	Lot LLLLL	Serial SSSS
	Datamatrix	Type&Ver TTTTTTVV	Lot number LLLLL	Serial SSSS	Date code WWYY	

Outline			
Pin table [mm]			
Pin	X	Y	Function
1	52,5	2,7	Boost2
2	52,5	0	Boost2
3	46	0	S25
4	43	1,4	G25
5	9,5	1,4	G15
6	6,5	0	S15
7	0	0	Boost1
8	0	2,7	Boost1
9	not assembled		
10	8,6	28,5	DC+Boost1
11	11,3	28,5	DC+Boost1
12	20,3	28,5	DC-Boost1
13	23	28,5	DC-Boost1
14	26	28,5	DC-Boost2
15	28,7	28,5	DC-Boost2
16	37,7	28,5	DC+Boost2
17	40,4	28,5	DC+Boost2
18	49,5	28,5	Therm1
19	52,5	28,5	Therm2
20	not assembled		
21	42,1	8,35	S27
22	39,1	8,85	G27
23	38,65	23,4	FC21
24	32,25	23,4	FC22
25	16,75	23,4	FC12
26	10,35	23,4	FC11
27	13,4	8,85	G17
28	10,4	8,35	S17

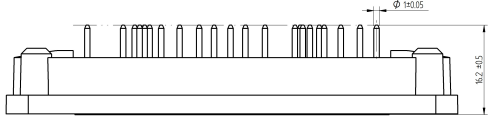
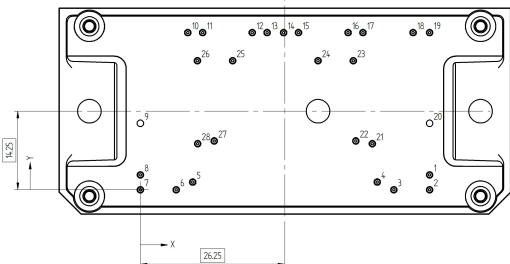
Tolerance of pinpositions: ±0.5mm at the end of pins
Dimension of coordinate axis is only offset without tolerance



Vincotech

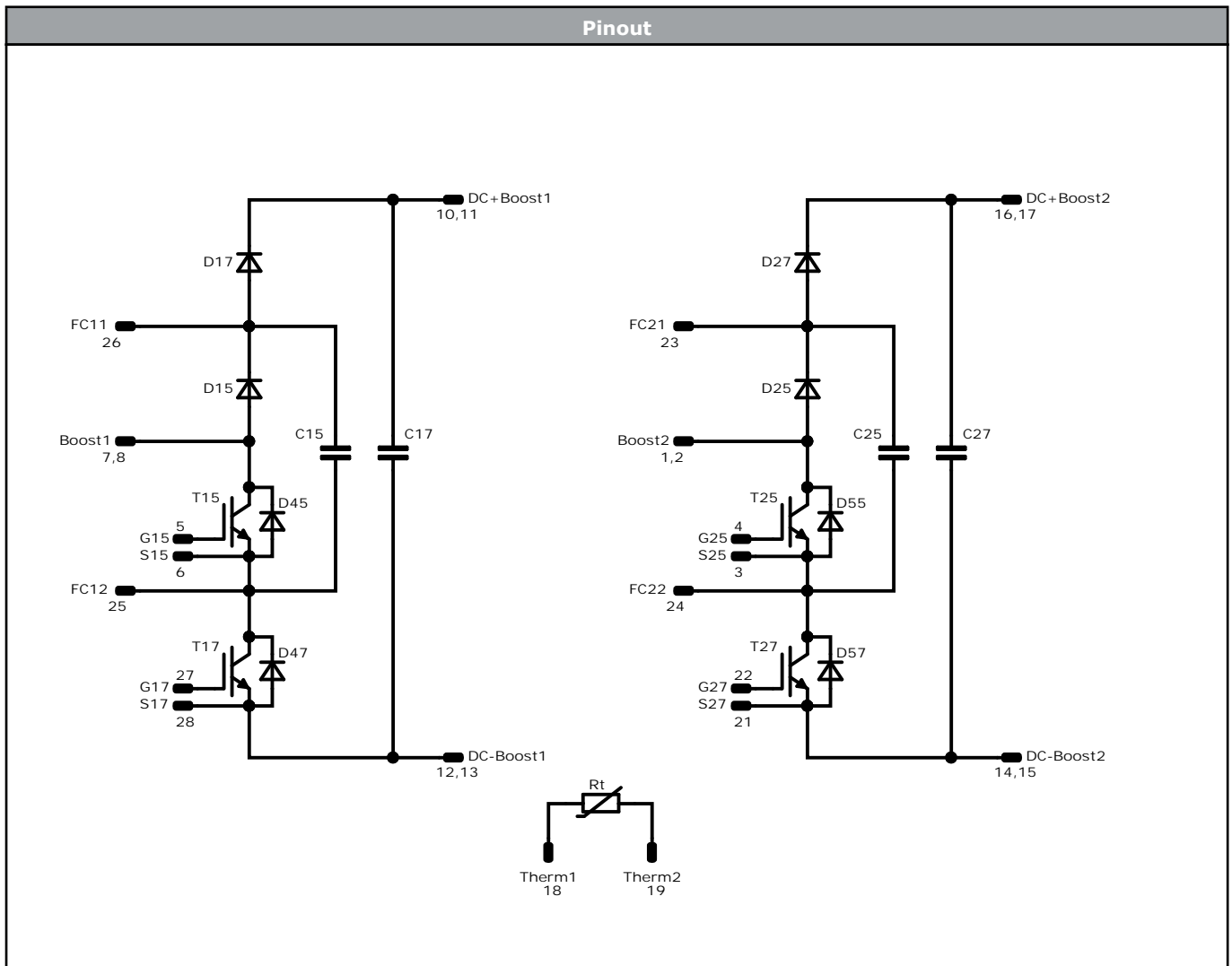

Identification					
ID	Component	Voltage	Current	Function	Comment
T15, T25	IGBT	950 V	100 A	Inner Boost Switch	
T17, T27	IGBT	950 V	100 A	Outer Boost Switch	
D15, D25	FWD	1200 V	30 A	Inner Boost Diode	
D17, D27	FWD	1200 V	30 A	Outer Boost Diode	
D45, D55	FWD	1200 V	35 A	Inner Boost Sw. Protection Diode	
D47, D57	FWD	1200 V	35 A	Outer Boost Sw. Protection Diode	
C15, C25	Capacitor	1000 V		Flying Capacitor	
C17, C27	Capacitor	1500 V		Capacitor (DC)	
Rt	Thermistor			Thermistor	



Vincotech

Packaging instruction				
Standard packaging quantity (SPQ) 100	>SPQ	Standard	<SPQ	Sample

Handling instruction
Handling instructions for <i>flow 1</i> packages see vincotech.com website.

Package data
Package data for <i>flow 1</i> packages see vincotech.com website.

Vincotech thermistor reference
See Vincotech thermistor reference table at vincotech.com website.

UL recognition and file number
This device is certified according to UL 1557 standard, UL file number E192116. For more information see vincotech.com website. 

Document No.:	Date:	Modification:	Pages
10-FY10B2A100S7-LP26L06-D1-14	11 Nov. 2020		

DISCLAIMER

The information, specifications, procedures, methods and recommendations herein (together "information") are presented by Vincotech to reader in good faith, are believed to be accurate and reliable, but may well be incomplete and/or not applicable to all conditions or situations that may exist or occur. Vincotech reserves the right to make any changes without further notice to any products to improve reliability, function or design. No representation, guarantee or warranty is made to reader as to the accuracy, reliability or completeness of said information or that the application or use of any of the same will avoid hazards, accidents, losses, damages or injury of any kind to persons or property or that the same will not infringe third parties rights or give desired results. It is reader's sole responsibility to test and determine the suitability of the information and the product for reader's intended use.

LIFE SUPPORT POLICY

Vincotech products are not authorised for use as critical components in life support devices or systems without the express written approval of Vincotech.

As used herein:

1. Life support devices or systems are devices or systems which, (a) are intended for surgical implant into the body, or (b) support or sustain life, or (c) whose failure to perform when properly used in accordance with instructions for use provided in labelling can be reasonably expected to result in significant injury to the user.
2. A critical component is any component of a life support device or system whose failure to perform can be reasonably expected to cause the failure of the life support device or system, or to affect its safety or effectiveness.

单击下面可查看定价，库存，交付和生命周期等信息

[>>Vincotech\(威科\)](#)