

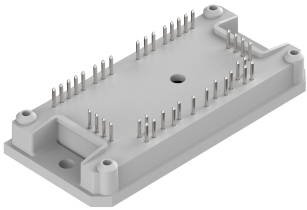

<b>fastPACK 1</b>		<b>650 V / 100 A</b>	
<b>Features</b>		<b>flow 1 12 mm housing</b>	
<ul style="list-style-type: none"><li>• High-efficient H-Bridge</li><li>• Open emitter topology</li><li>• Fast IGBT H5 + Fast Rapid 1 Diode</li><li>• Integrated capacitors</li><li>• Integrated thermistor</li><li>• Low inductive 12mm housing</li></ul>			
<b>Target applications</b>		<b>Schematic</b>	
<ul style="list-style-type: none"><li>• Power Supply</li><li>• Solar Inverters</li><li>• Welding &amp; Cutting</li></ul>			
<b>Types</b>			
<ul style="list-style-type: none"><li>• 10-FY074PA100SM01-L583F18</li></ul>			

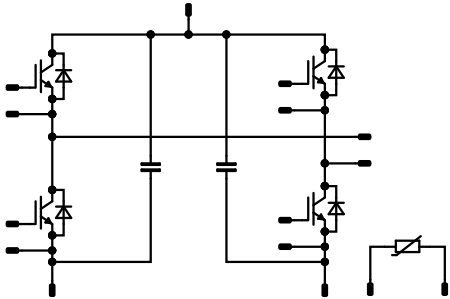

Vincotech

## Maximum Ratings

$T_j = 25\text{ °C}$ , unless otherwise specified

Parameter	Symbol	Conditions	Value	Unit
<b>H-Bridge Switch</b>				
Collector-emitter voltage	$V_{CES}$		650	V
Collector current (DC current)	$I_C$	$T_j = T_{jmax}$ $T_s = 80\text{ °C}$	80	A
Repetitive peak collector current	$I_{CRM}$	$t_p$ limited by $T_{jmax}$	300	A
Total power dissipation	$P_{tot}$	$T_j = T_{jmax}$ $T_s = 80\text{ °C}$	138	W
Gate-emitter voltage	$V_{GES}$		±20	V
Maximum junction temperature	$T_{jmax}$		175	°C

## H-Bridge Diode

Peak repetitive reverse voltage	$V_{RRM}$		650	V
Forward current (DC current)	$I_F$	$T_j = T_{jmax}$ $T_s = 80\text{ °C}$	99	A
Repetitive peak forward current	$I_{FRM}$	$t_p$ limited by $T_{jmax}$	180	A
Total power dissipation	$P_{tot}$	$T_j = T_{jmax}$ $T_s = 80\text{ °C}$	138	W
Maximum junction temperature	$T_{jmax}$		175	°C

## Capacitor (DC)

Maximum DC voltage	$V_{MAX}$		630	V
Operation Temperature	$T_{op}$		-55 ... 125	°C

## Module Properties

### Thermal Properties

Storage temperature	$T_{stg}$		-40...+125	°C
Operation temperature under switching condition	$T_{jop}$		-40...+( $T_{jmax} - 25$ )	°C

### Isolation Properties

Isolation voltage	$V_{isol}$	DC Test Voltage* $t_p = 2\text{ s}$	6000	V
Isolation voltage	$V_{isol}$	AC Voltage $t_p = 1\text{ min}$	2500	V
Creepage distance			>12,7	mm
Clearance			7,66	mm
Comparative Tracking Index	CTI		≥ 200	

\*100 % tested in production



Vincotech

### Characteristic Values

Parameter	Symbol	Conditions					Values			Unit
		$V_{GS}$ [V]	$V_{GE}$ [V]	$V_{DS}$ [V]	$I_C$ [A]	$T_j$ [°C]	Min	Typ	Max	

#### H-Bridge Switch

##### Static

Gate-emitter threshold voltage	$V_{GE(th)}$	$V_{CE} = V_{GE}$			0,001	25	3,3	4	4,7	V
Collector-emitter saturation voltage	$V_{CE(sat)}$		15		100	25 125		1,63 1,78	2,22 <sup>(1)</sup>	V
Collector-emitter cut-off current	$I_{CES}$		0	650		25			80	μA
Gate-emitter leakage current	$I_{GES}$		20	0		25			240	nA
Internal gate resistance	$r_g$							None		Ω
Input capacitance	$C_{ies}$							6000		pF
Output capacitance	$C_{oes}$	$f = 1$ Mhz	0	25		25		100		pF
Reverse transfer capacitance	$C_{res}$							22		pF
Gate charge	$Q_g$		15	520	100	25		240		nC

##### Thermal

Thermal resistance junction to sink <sup>(2)</sup>	$R_{th(j-s)}$	$\lambda_{paste} = 3,4$ W/mK (PSX)						0,69		K/W
--	---------------	------------------------------------	--	--	--	--	--	------	--	-----

##### Dynamic

Turn-on delay time	$t_{d(on)}$					25 125 150		43 44 46		ns
Rise time	$t_r$	$R_{gon} = 4$ Ω $R_{goff} = 4$ Ω				25 125 150		12 15 15		ns
Turn-off delay time	$t_{d(off)}$		-5/15	350	100	25 125 150		104 119 121		ns
Fall time	$t_f$					25 125 150		7,78 11,1 11,73		ns
Turn-on energy (per pulse)	$E_{on}$	$Q_{tFWD} = 3,14$ μC $Q_{tFWD} = 5,88$ μC $Q_{tFWD} = 6,52$ μC				25 125 150		1,36 1,74 1,87		mWs
Turn-off energy (per pulse)	$E_{off}$					25 125 150		0,426 0,817 0,881		mWs



Vincotech

### Characteristic Values

Parameter	Symbol	Conditions					Values			Unit
		$V_{GE}$ [V] $V_{GS}$ [V]	$V_{CE}$ [V] $V_{DS}$ [V] $V_F$ [V]	$I_C$ [A] $I_D$ [A] $I_F$ [A]	$T_j$ [°C]	Min	Typ	Max		

### H-Bridge Diode

#### Static

Forward voltage	$V_F$				90	25 125 150		1,47 1,4 1,37	1,92 <sup>(1)</sup>	V
Reverse leakage current	$I_R$	$V_r = 650$ V				25			4,8	μA

#### Thermal

Thermal resistance junction to sink <sup>(2)</sup>	$R_{th(j-s)}$	$\lambda_{paste} = 3,4$ W/mK (PSX)						0,69		K/W
--	---------------	---------------------------------------	--	--	--	--	--	------	--	-----

#### Dynamic

Peak recovery current	$I_{RRM}$					25 125 150		91,53 113,98 119,16		A
Reverse recovery time	$t_{rr}$					25 125 150		62,09 102,9 111		ns
Recovered charge	$Q_r$	$di/dt=5731$ A/μs $di/dt=5891$ A/μs $di/dt=5864$ A/μs	-5/15	350	100	25 125 150		3,14 5,88 6,52		μC
Reverse recovered energy	$E_{rec}$					25 125 150		0,724 1,46 1,61		mWs
Peak rate of fall of recovery current	$(di_r/dt)_{max}$					25 125 150		1275 1186 1270		A/μs



Vincotech

### Characteristic Values

Parameter	Symbol	Conditions					Values			Unit
		$V_{GE}$ [V] $V_{GS}$ [V]	$V_{CE}$ [V] $V_{DS}$ [V] $V_F$ [V]	$I_C$ [A] $I_D$ [A] $I_F$ [A]	$T_j$ [°C]	Min	Typ	Max		

### Capacitor (DC)

#### Static

Capacitance	$C$	DC bias voltage = 0 V				25		200		nF
Tolerance							-10		10	%
Dissipation factor		$f = 1$ kHz				25		2,5		%

### Thermistor

#### Static

Rated resistance	$R$					25		22		k $\Omega$
Deviation of $R_{100}$	$A_{R/R}$	$R_{100} = 1484 \Omega$				100	-5		5	%
Power dissipation	$P$							5		mW
Power dissipation constant	$d$					25		1,5		mW/K
B-value	$B_{(25/50)}$	Tol. $\pm 1$ %						3962		K
B-value	$B_{(25/100)}$	Tol. $\pm 1$ %						4000		K
Vincotech Thermistor Reference									I	

(1) Value at chip level

(2) Only valid with pre-applied Vincotech thermal interface material.



## H-Bridge Switch Characteristics

**figure 1.** IGBT

Typical output characteristics  
 $I_C = f(V_{CE})$

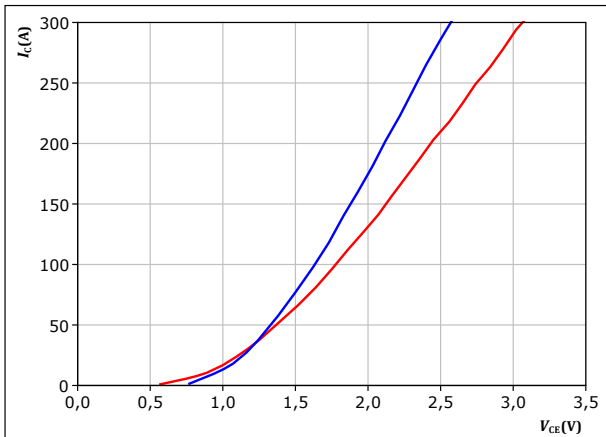

$t_p = 250 \mu s$   
 $V_{GE} = 15 V$   
 $T_j:$  — 25 °C  
— 125 °C

**figure 2.** IGBT

Typical output characteristics  
 $I_C = f(V_{CE})$

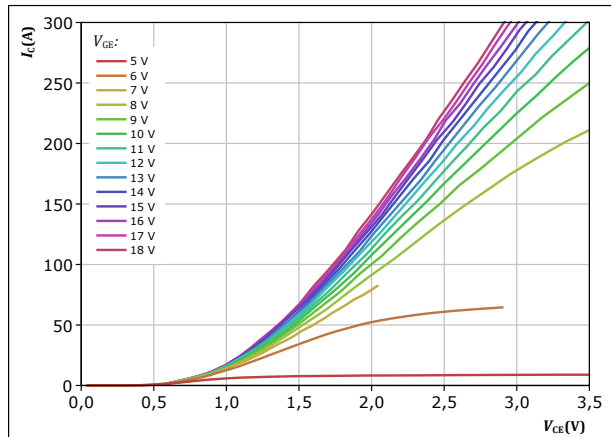

$t_p = 250 \mu s$   
 $T_j = 125 \text{ } ^\circ C$   
 $V_{GE}$  from 5 V to 18 V in steps of 1 V

**figure 3.** IGBT

Typical transfer characteristics  
 $I_C = f(V_{GE})$

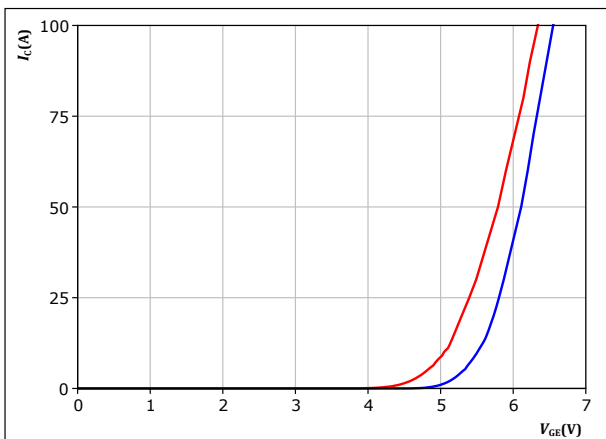

$t_p = 250 \mu s$   
 $V_{CE} = 10 V$   
 $T_j:$  — 25 °C  
— 125 °C

**figure 4.** IGBT

Transient thermal impedance as a function of pulse width  
 $Z_{th(j-s)} = f(t_p)$

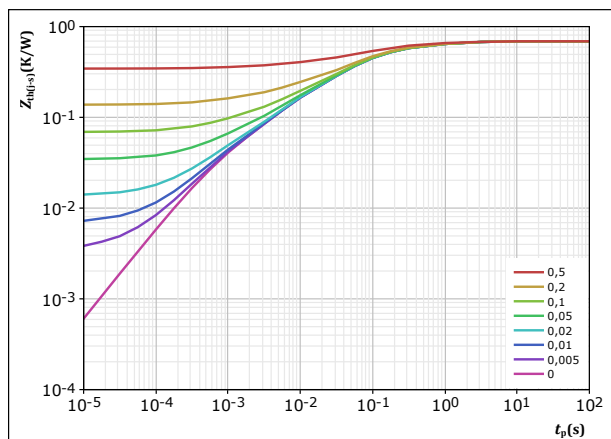

$D = t_p / T$   
 $R_{th(j-s)} = 0,689 \text{ K/W}$   
IGBT thermal model values  

R (K/W)	$\tau$ (s)
7,95E-02	1,67E+00
1,86E-01	2,17E-01
2,94E-01	5,38E-02
1,03E-01	6,67E-03
2,63E-02	6,74E-04



Vincotech

## H-Bridge Switch Characteristics

figure 5. IGBT

Safe operating area

$$I_C = f(V_{CE})$$

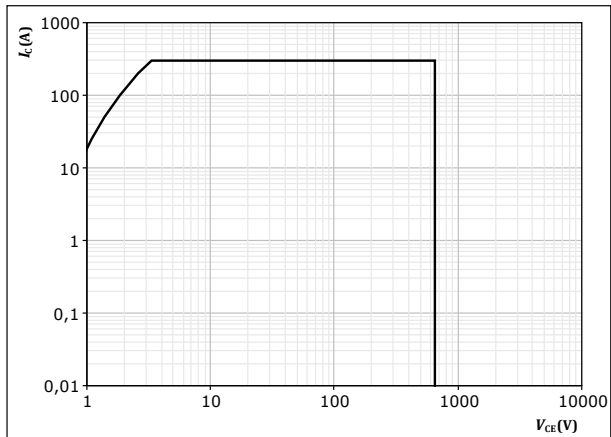

$D =$  single pulse  
 $T_s = 80$  °C  
 $V_{GE} = 15$  V  
 $T_j = T_{jmax}$



## H-Bridge Diode Characteristics

figure 6. FWD

Typical forward characteristics

$$I_F = f(V_F)$$

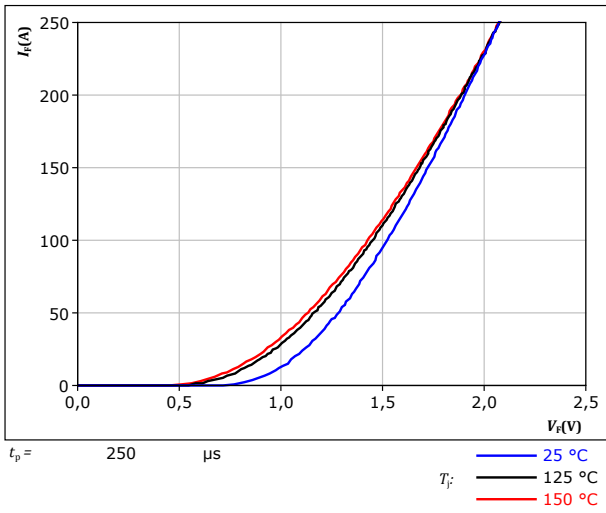
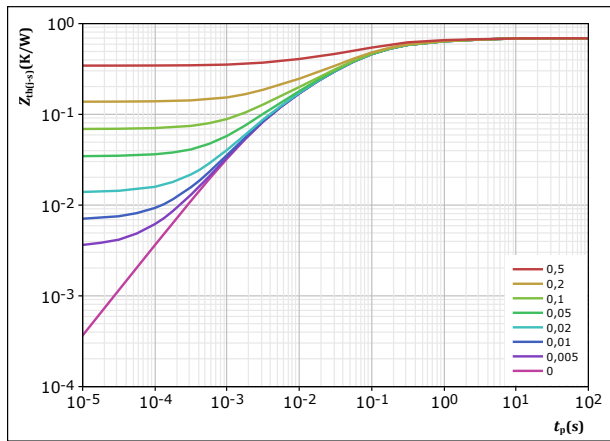

figure 7. FWD

Transient thermal impedance as a function of pulse width

$$Z_{th(j-s)} = f(t_p)$$



$D =$	$t_p / T$	
$R_{th(j-s)} =$	0,689	K/W
FWD thermal model values		
$R$ (K/W)	$\tau$ (s)	
6,10E-02	3,01E+00	
1,19E-01	3,45E-01	
3,11E-01	7,41E-02	
1,35E-01	1,50E-02	
6,36E-02	2,75E-03	





### Thermistor Characteristics

figure 8. Thermistor

Typical NTC characteristic as function of temperature

$$R_T = f(T)$$

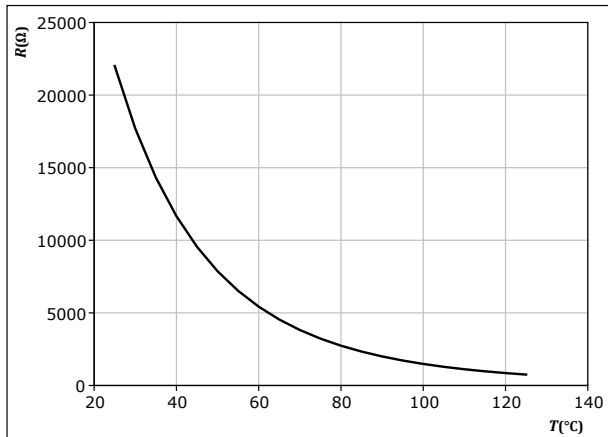



## H-Bridge Switching Characteristics

**figure 9.** IGBT

Typical switching energy losses as a function of collector current  
 $E = f(I_c)$

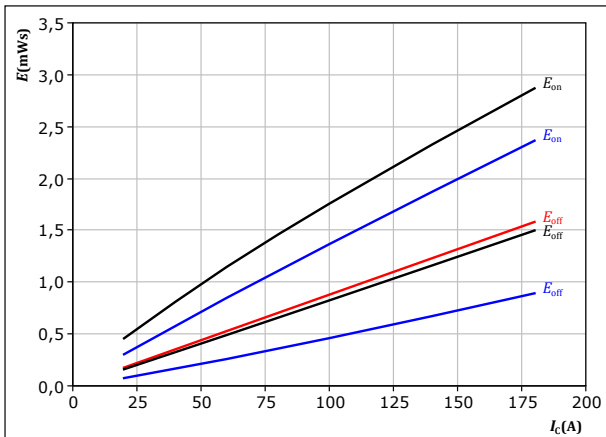

With an inductive load at  
 $V_{CE} = 350$  V  
 $V_{GE} = -5/15$  V  
 $R_{gon} = 4$   $\Omega$   
 $R_{goff} = 4$   $\Omega$

$T_j$ : 25 °C (blue), 125 °C (black), 150 °C (red)

**figure 10.** IGBT

Typical switching energy losses as a function of gate resistor  
 $E = f(R_g)$

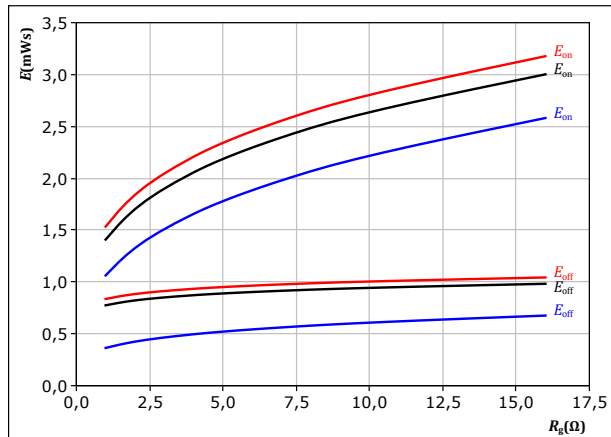

With an inductive load at  
 $V_{CE} = 350$  V  
 $V_{GE} = -5/15$  V  
 $I_c = 100$  A

$T_j$ : 25 °C (blue), 125 °C (black), 150 °C (red)

**figure 11.** FWD

Typical reverse recovered energy loss as a function of collector current  
 $E_{rec} = f(I_c)$

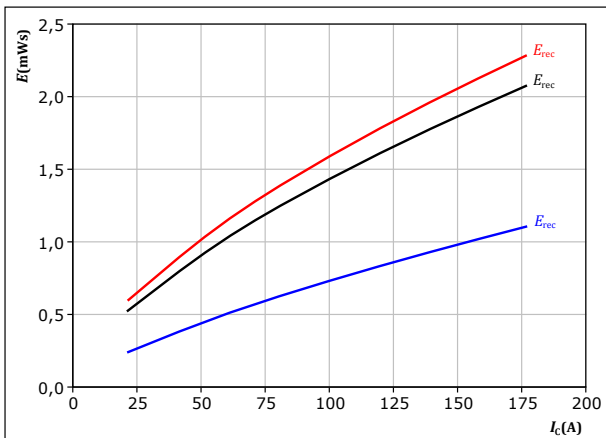

With an inductive load at  
 $V_{CE} = 350$  V  
 $V_{GE} = -5/15$  V  
 $R_{gon} = 4$   $\Omega$

$T_j$ : 25 °C (blue), 125 °C (black), 150 °C (red)

**figure 12.** FWD

Typical reverse recovered energy loss as a function of gate resistor  
 $E_{rec} = f(R_g)$

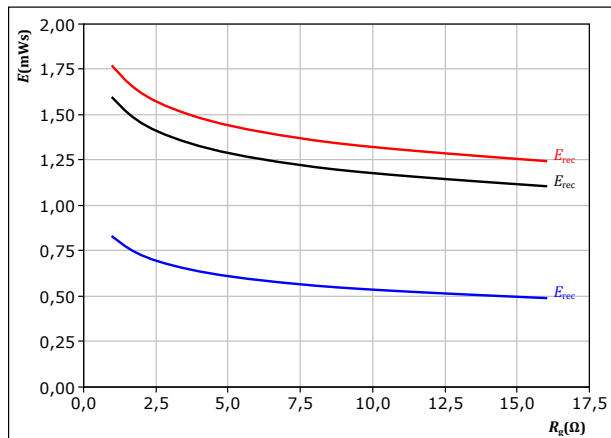

With an inductive load at  
 $V_{CE} = 350$  V  
 $V_{GE} = -5/15$  V  
 $I_c = 100$  A

$T_j$ : 25 °C (blue), 125 °C (black), 150 °C (red)



## H-Bridge Switching Characteristics

**figure 13.** IGBT

Typical switching times as a function of collector current  
 $t = f(I_c)$

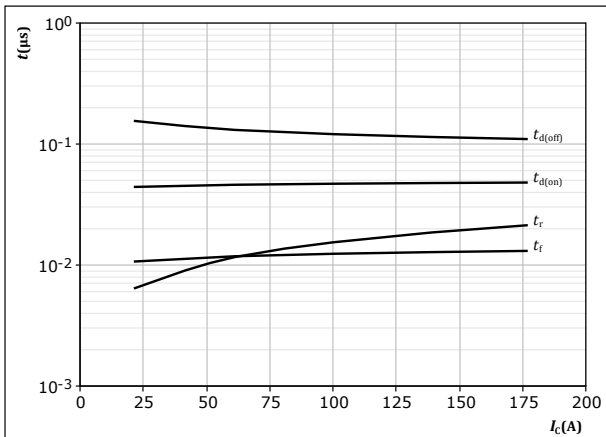

With an inductive load at  
 $T_j = 150 \text{ }^\circ\text{C}$   
 $V_{CE} = 350 \text{ V}$   
 $V_{GE} = -5/15 \text{ V}$   
 $R_{g(on)} = 4 \text{ } \Omega$   
 $R_{g(off)} = 4 \text{ } \Omega$

**figure 14.** IGBT

Typical switching times as a function of gate resistor  
 $t = f(R_g)$

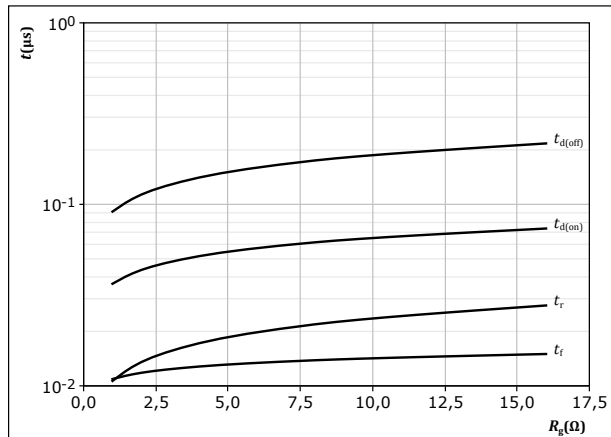

With an inductive load at  
 $T_j = 150 \text{ }^\circ\text{C}$   
 $V_{CE} = 350 \text{ V}$   
 $V_{GE} = -5/15 \text{ V}$   
 $I_c = 100 \text{ A}$

**figure 15.** FWD

Typical reverse recovery time as a function of collector current  
 $t_{rr} = f(I_c)$

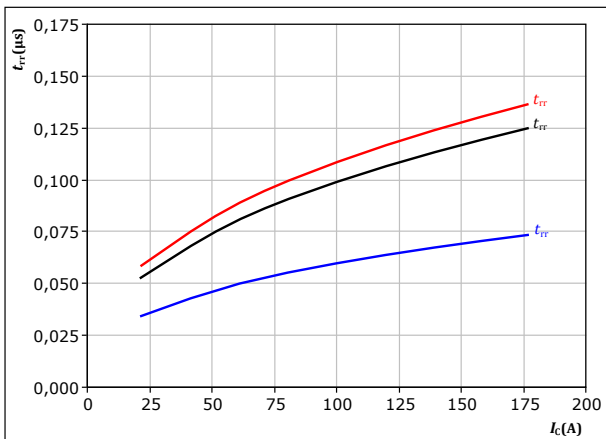

With an inductive load at  
 $V_{CE} = 350 \text{ V}$   
 $V_{GE} = -5/15 \text{ V}$   
 $R_{g(on)} = 4 \text{ } \Omega$   
 $T_j: \text{ } \text{---} 25 \text{ }^\circ\text{C}$   
 $\text{---} 125 \text{ }^\circ\text{C}$   
 $\text{---} 150 \text{ }^\circ\text{C}$

**figure 16.** FWD

Typical reverse recovery time as a function of IGBT turn off gate resistor  
 $t_{rr} = f(R_{g(off)})$

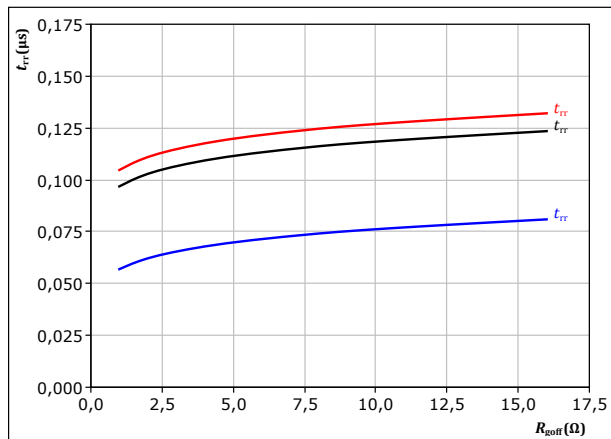

With an inductive load at  
 $V_{CE} = 350 \text{ V}$   
 $V_{GE} = -5/15 \text{ V}$   
 $I_c = 100 \text{ A}$   
 $T_j: \text{ } \text{---} 25 \text{ }^\circ\text{C}$   
 $\text{---} 125 \text{ }^\circ\text{C}$   
 $\text{---} 150 \text{ }^\circ\text{C}$



## H-Bridge Switching Characteristics

**figure 17.** FWD

Typical recovered charge as a function of collector current

$$Q_r = f(I_c)$$

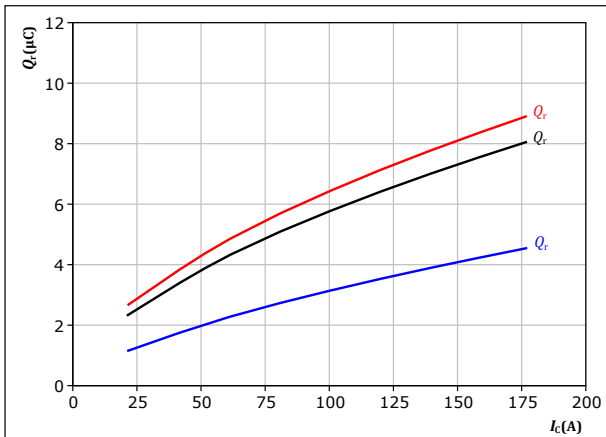

With an inductive load at

$V_{CE} = 350$  V  
 $V_{GE} = -5/15$  V  
 $R_{goff} = 4$   $\Omega$

$T_j$ : 25 °C (blue), 125 °C (black), 150 °C (red)

**figure 19.** FWD

Typical peak reverse recovery current as a function of collector current

$$I_{RM} = f(I_c)$$

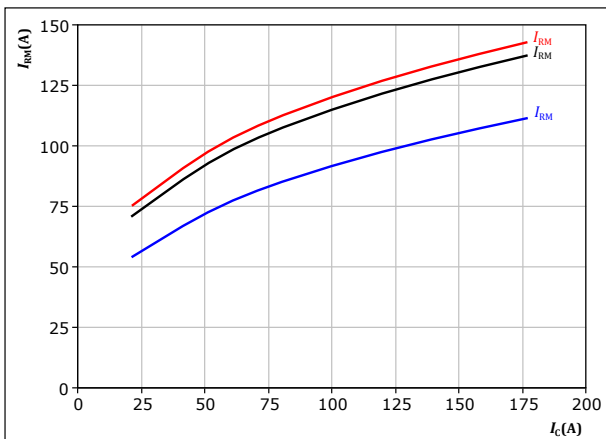

With an inductive load at

$V_{CE} = 350$  V  
 $V_{GE} = -5/15$  V  
 $R_{goff} = 4$   $\Omega$

$T_j$ : 25 °C (blue), 125 °C (black), 150 °C (red)

**figure 18.** FWD

Typical recovered charge as a function of turn off gate resistor

$$Q_r = f(R_{goff})$$

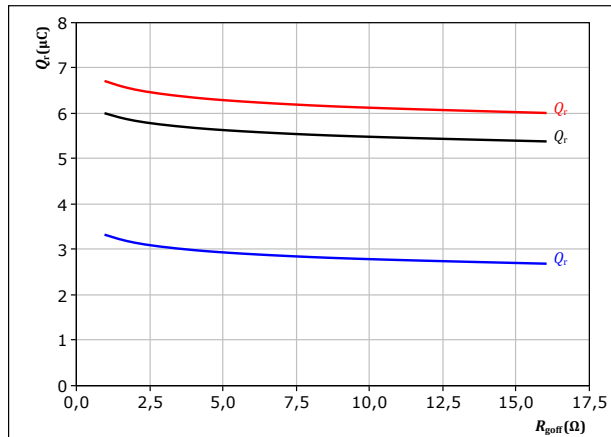

With an inductive load at

$V_{CE} = 350$  V  
 $V_{GE} = -5/15$  V  
 $I_c = 100$  A

$T_j$ : 25 °C (blue), 125 °C (black), 150 °C (red)

**figure 20.** FWD

Typical peak reverse recovery current as a function of turn off gate resistor

$$I_{RM} = f(R_{goff})$$

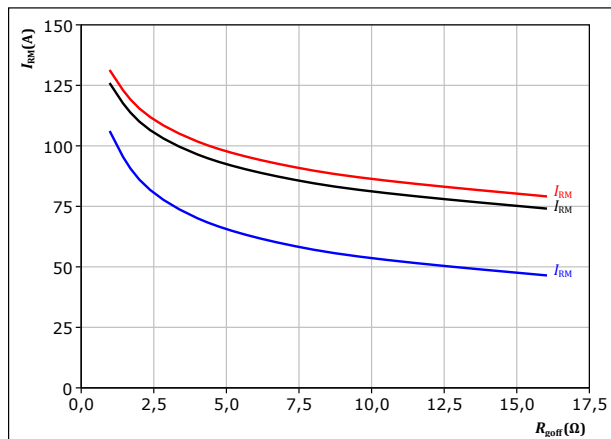

With an inductive load at

$V_{CE} = 350$  V  
 $V_{GE} = -5/15$  V  
 $I_c = 100$  A

$T_j$ : 25 °C (blue), 125 °C (black), 150 °C (red)



## H-Bridge Switching Characteristics

**figure 21.** FWD

Typical rate of fall of forward and reverse recovery current as a function of collector current  
 $di_i/dt, di_r/dt = f(I_c)$

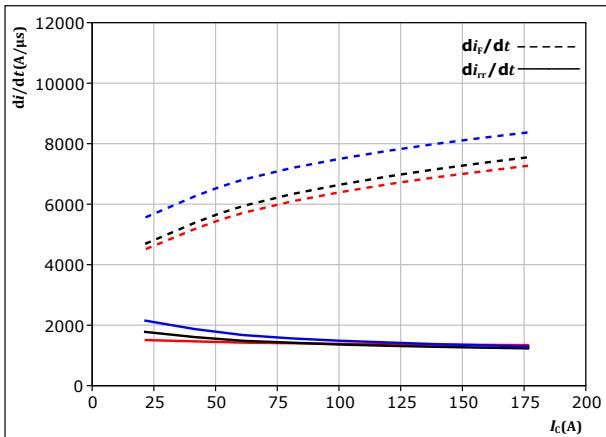

With an inductive load at  
 $V_{CE} = 350$  V  
 $V_{GE} = -5/15$  V  
 $R_{goff} = 4$  Ω  
 $T_j = 25$  °C  
 $T_j = 125$  °C  
 $T_j = 150$  °C

**figure 22.** FWD

Typical rate of fall of forward and reverse recovery current as a function of turn off gate resistor  
 $di_i/dt, di_r/dt = f(R_{goff})$

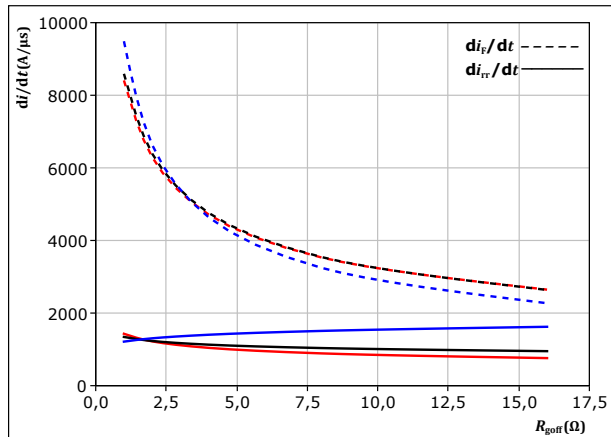

With an inductive load at  
 $V_{CE} = 350$  V  
 $V_{GE} = -5/15$  V  
 $I_c = 100$  A  
 $T_j = 25$  °C  
 $T_j = 125$  °C  
 $T_j = 150$  °C

**figure 23.** IGBT

Reverse bias safe operating area  
 $I_c = f(V_{CE})$

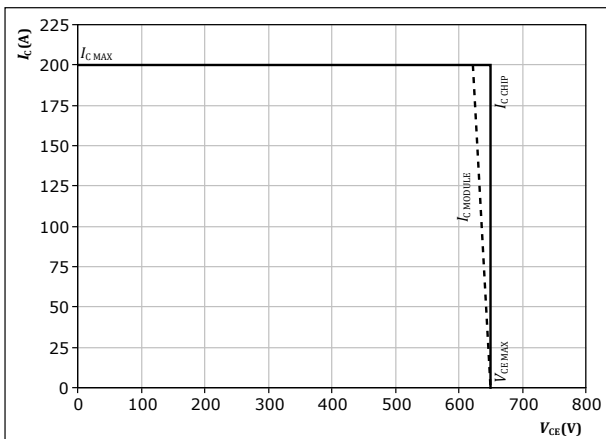

At  $T_j = 150$  °C  
 $R_{goff} = 4$  Ω  
 $R_{goff} = 4$  Ω



## H-Bridge Switching Definitions

**figure 24.** IGBT

Turn-off Switching Waveforms & definition of  $t_{doff}$ ,  $t_{Eoff}$  ( $t_{Eoff}$  = integrating time for  $E_{off}$ )

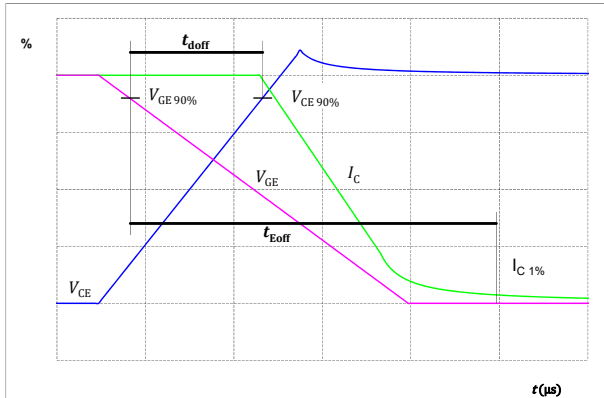

**figure 25.** IGBT

Turn-on Switching Waveforms & definition of  $t_{don}$ ,  $t_{Eon}$  ( $t_{Eon}$  = integrating time for  $E_{on}$ )

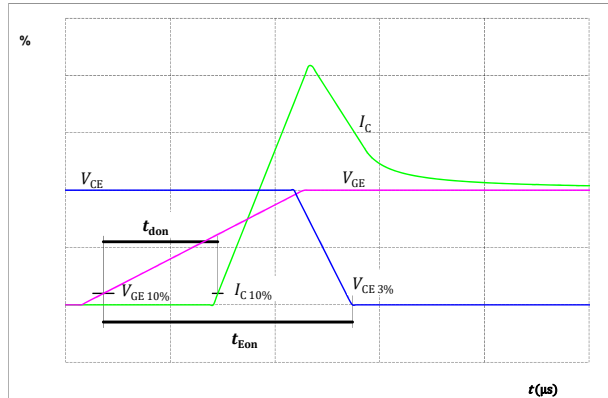

**figure 26.** IGBT

Turn-off Switching Waveforms & definition of  $t_f$

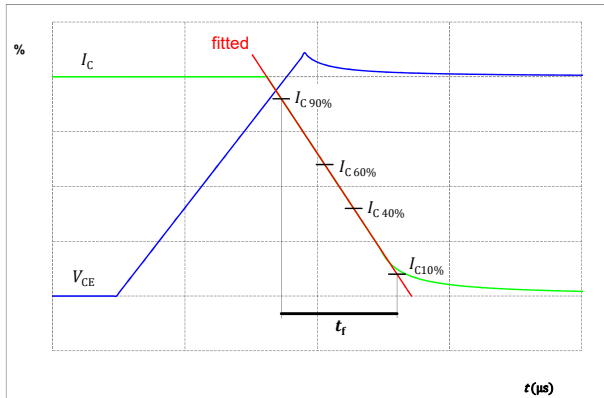

**figure 27.** IGBT

Turn-on Switching Waveforms & definition of  $t_r$

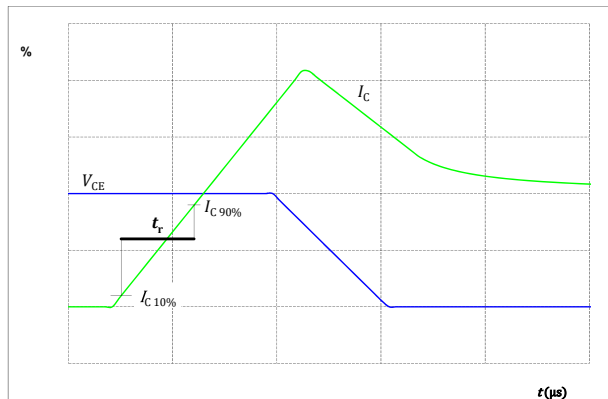



### H-Bridge Switching Definitions

figure 28. FWD

Turn-off Switching Waveforms & definition of  $t_{rr}$



figure 29. FWD

Turn-on Switching Waveforms & definition of  $t_{Qr}$  ( $t_{Qr}$  = integrating time for  $Q_r$ )

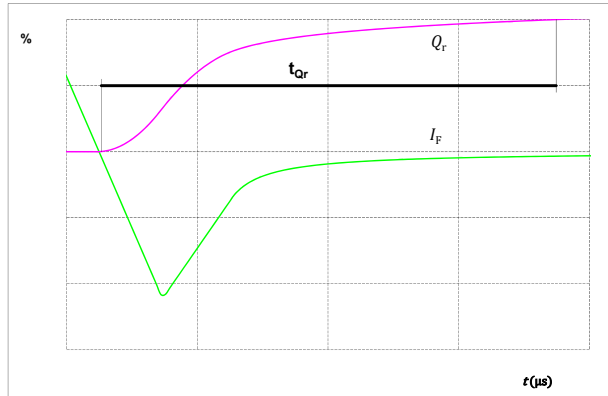



# 10-FY074PA100SM01-L583F18

datasheet

## Vincotech

Ordering Code	
Version	Ordering Code
Without thermal paste	10-FY074PA100SM01-L583F18
With thermal paste (5,2 W/mK, PTM6000HV)	10-FY074PA100SM01-L583F18-/7/
With thermal paste (3,4 W/mK, PSX-P7)	10-FY074PA100SM01-L583F18-/3/

Marking						
	Text	Name	Date code	UL & VIN	Lot	Serial
		NN-NNNNNNNNNNNNNN- TTTTIV	WWYY	UL VIN	LLLLL	SSSS
Datamatrix	Type&Ver	Lot number	Serial	Date code		
	TTTTTIV	LLLLL	SSSS	WWYY		

Pin table [mm]			
Pin	X	Y	Function
1	46,3	2,7	DC-2
2	46,3	0	DC-2
3	43,6	2,7	DC-2
4	43,6	0	DC-2
5	39,2	1	G13-a
6	36,2	0	S13
7	33,2	1	G13-b
8	28,8	0	Therm2
9	23,8	0	Therm1
10	19,4	1	G11-b
11	16,4	0	S11
12	13,4	1	G11-a
13	9	2,7	DC-1
14	9	0	DC-1
15	6,3	2,7	DC-1
16	6,3	0	DC-1
17	0	6,8	DC+
18	0	9,5	DC+
19	0	12,2	DC+
20	0	14,9	DC+
21	0	28,6	Ph1
22	2,7	28,6	Ph1
23	5,4	28,6	Ph1
24	8,1	28,6	Ph1
25	10,8	28,6	Ph1
26	15,25	28,6	G12-a
27	18,25	28,6	S12
28	21,25	28,6	G12-b
29	31,35	28,6	G14-b
30	34,35	28,6	S14
31	37,35	28,6	G14-a
32	41,8	28,6	Ph2
33	44,5	28,6	Ph2
34	47,2	28,6	Ph2
35	49,9	28,6	Ph2
36	52,6	28,6	Ph2
37	52,6	14,9	DC+
38	52,6	12,2	DC+
39	52,6	9,5	DC+
40	52,6	6,8	DC+

Tolerance of pinpositions: ±0.5mm at the end of pins  
Dimension of coordinate axis is only offset without tolerance





Vincotech

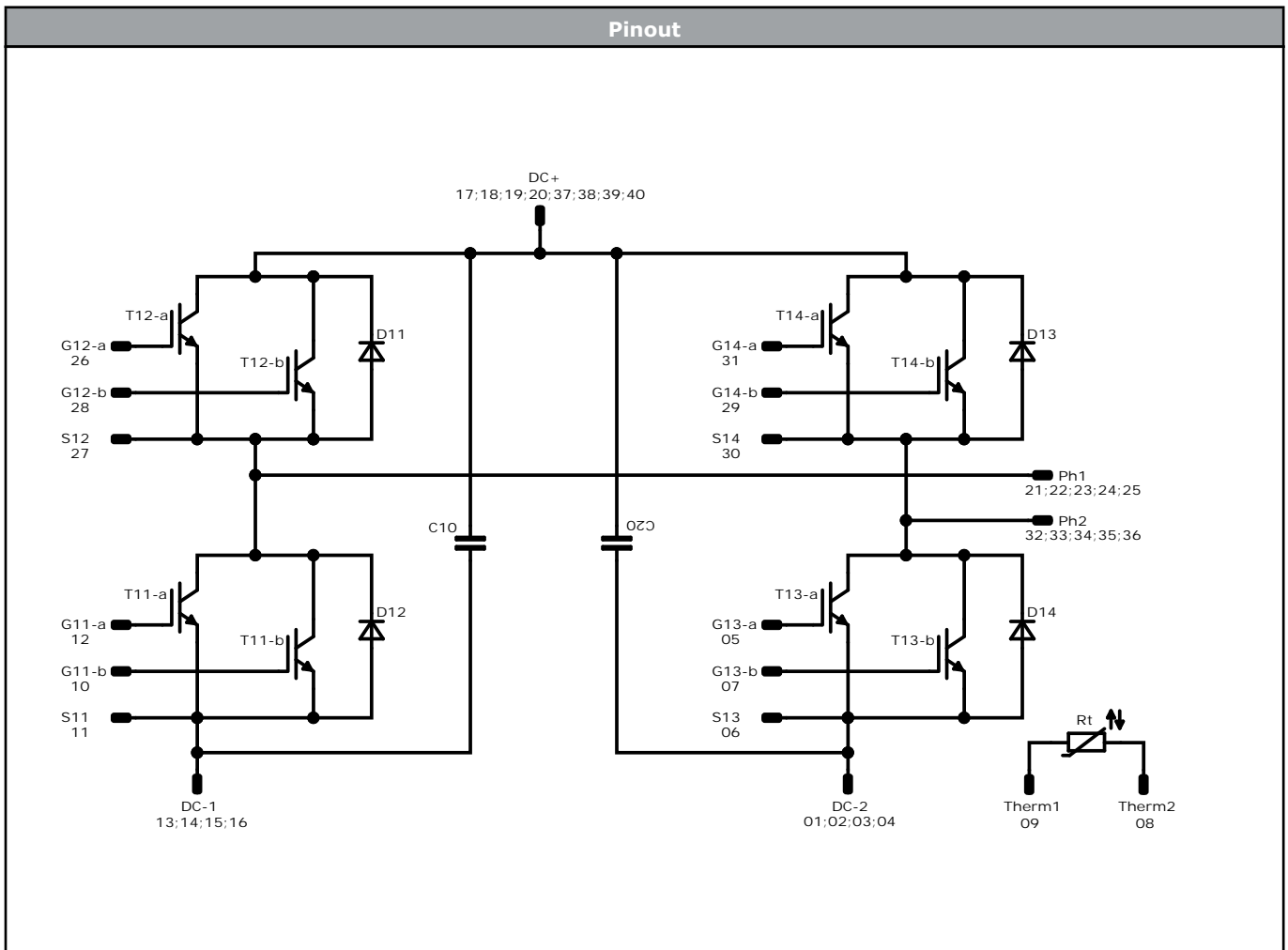

Identification					
ID	Component	Voltage	Current	Function	Comment
T11, T12, T13, T14	IGBT	650 V	100 A	H-Bridge Switch	
D11, D12, D13, D14	FWD	650 V	90 A	H-Bridge Diode	
C10, C20	Capacitor	630 V		Capacitor (DC)	
Rt	NTC			Thermistor	



Vincotech

Packaging instruction				
Standard packaging quantity (SPQ) 100	>SPQ	Standard	<SPQ	Sample

Handling instruction
Handling instructions for <i>flow 1</i> packages see vincotech.com website.

Package data
Package data for <i>flow 1</i> packages see vincotech.com website.

Vincotech thermistor reference
See Vincotech thermistor reference table at vincotech.com website.

UL recognition and file number
This device is certified according to UL 1557 standard, UL file number E192116. For more information see vincotech.com website. 

Document No.:	Date:	Modification:	Pages
10-FY074PA100SM01-L583F18-D3-14	9 Sep. 2021	Thermal characteristics are updated Separated datasheet for solder pin version New datasheet format, module is unchanged	

**DISCLAIMER**

The information, specifications, procedures, methods and recommendations herein (together "information") are presented by Vincotech to reader in good faith, are believed to be accurate and reliable, but may well be incomplete and/or not applicable to all conditions or situations that may exist or occur. Vincotech reserves the right to make any changes without further notice to any products to improve reliability, function or design. No representation, guarantee or warranty is made to reader as to the accuracy, reliability or completeness of said information or that the application or use of any of the same will avoid hazards, accidents, losses, damages or injury of any kind to persons or property or that the same will not infringe third parties rights or give desired results. It is reader's sole responsibility to test and determine the suitability of the information and the product for reader's intended use.

**LIFE SUPPORT POLICY**

Vincotech products are not authorised for use as critical components in life support devices or systems without the express written approval of Vincotech.

As used herein:

1. Life support devices or systems are devices or systems which, (a) are intended for surgical implant into the body, or (b) support or sustain life, or (c) whose failure to perform when properly used in accordance with instructions for use provided in labelling can be reasonably expected to result in significant injury to the user.
2. A critical component is any component of a life support device or system whose failure to perform can be reasonably expected to cause the failure of the life support device or system, or to affect its safety or effectiveness.

单击下面可查看定价，库存，交付和生命周期等信息

[>>Vincotech\(威科\)](#)