



<b>flow PIM 0</b>		<b>600 V / 10 A</b>	
<div style="border: 1px solid black; padding: 5px; margin-bottom: 5px;"> <p style="text-align: center; margin: 0;"><b>Features</b></p> <ul style="list-style-type: none"> <li>Clip-in housing</li> <li>Trenchstop™ IGBT3 for low saturation losses</li> <li>Optional w/o BRC</li> </ul> </div> <div style="border: 1px solid black; padding: 5px; margin-bottom: 5px;"> <p style="text-align: center; margin: 0;"><b>Target Applications</b></p> <ul style="list-style-type: none"> <li>Industrial drives</li> <li>Embedded drives</li> </ul> </div> <div style="border: 1px solid black; padding: 5px;"> <p style="text-align: center; margin: 0;"><b>Types</b></p> <ul style="list-style-type: none"> <li>V23990-P543-A28-PM</li> <li>V23990-P543-A29-PM</li> <li>V23990-P543-B28-PM</li> <li>V23990-P543-B128-PM</li> <li>V23990-P543-B129-PM</li> <li>V23990-P543-C28-PM</li> <li>V23990-P543-C29-PM</li> <li>V23990-P543-D28-PM</li> <li>V23990-P543-D129-PM</li> </ul> </div>	<div style="border: 1px solid black; padding: 5px; margin-bottom: 5px;"> <p style="text-align: center; margin: 0;"><b>flow 0 housing</b></p> <div style="display: flex; justify-content: space-around; align-items: center;"> </div> <div style="display: flex; justify-content: space-around; margin-top: 5px;"> <span>12mm housing</span> <span>17mm housing</span> </div> </div> <div style="border: 1px solid black; padding: 5px;"> <p style="text-align: center; margin: 0;"><b>Schematic</b></p> </div>		

## Maximum Ratings

$T_j=25^{\circ}\text{C}$ , unless otherwise specified

Parameter	Symbol	Condition	Value	Unit	
<b>Rectifier Diode</b>					
Repetitive peak reverse voltage	$V_{RRM}$		1600	V	
DC forward current	$I_{FAV}$	$T_j = T_{jmax}$	$T_s = 80^{\circ}\text{C}$ $T_c = 80^{\circ}\text{C}$	34 42	A
Surge (non-repetitive) forward current	$I_{FSM}$	$t_p = 10\text{ ms}$	$T_j = 25^{\circ}\text{C}$	200	A
I2t-value	$I^2t$	50 Hz half sine wave		200	$\text{A}^2\text{s}$
Power dissipation	$P_{tot}$	$T_j = T_{jmax}$	$T_s = 80^{\circ}\text{C}$ $T_c = 80^{\circ}\text{C}$	43 66	W
Maximum Junction Temperature	$T_{jmax}$		150	$^{\circ}\text{C}$	
<b>Inverter Switch</b>					
Collector-emitter breakdown voltage	$V_{CE}$		600	V	
DC collector current	$I_C$	$T_j = T_{jmax}$	$T_s = 80^{\circ}\text{C}$ $T_c = 80^{\circ}\text{C}$	14 14	A
Repetitive peak collector current	$I_{CRM}$	$t_p$ limited by $T_{jmax}$		30	A
Turn off safe operating area		$V_{CE} \leq 1200\text{ V}, T_j \leq T_{op\ max}$		30	A
Power dissipation	$P_{tot}$	$T_j = T_{jmax}$	$T_s = 80^{\circ}\text{C}$ $T_c = 80^{\circ}\text{C}$	44 66	W
Gate-emitter peak voltage	$V_{GE}$		$\pm 20$	V	
Short circuit ratings	$t_{SC}$ $V_{CC}$	$T_j \leq 150^{\circ}\text{C}$ $V_{GE} = 15\text{ V}$		6 360	$\mu\text{s}$ V
Maximum Junction Temperature	$T_{jmax}$		175	$^{\circ}\text{C}$	

**Maximum Ratings** $T_i=25^{\circ}\text{C}$ , unless otherwise specified

Parameter	Symbol	Condition	Value	Unit
-----------	--------	-----------	-------	------

**Inverter Diode**

Peak Repetitive Reverse Voltage	$V_{RRM}$		600	V
DC forward current	$I_F$	$T_j = T_{jmax}$ $T_s = 80^{\circ}\text{C}$ $T_c = 80^{\circ}\text{C}$	14 14	A
Repetitive peak forward current	$I_{FRM}$	$t_p$ limited by $T_{jmax}$	20	A
Power dissipation	$P_{tot}$	$T_j = T_{jmax}$ $T_s = 80^{\circ}\text{C}$ $T_c = 80^{\circ}\text{C}$	21 29	W
Maximum Junction Temperature	$T_{jmax}$		175	$^{\circ}\text{C}$

**Brake Switch**

Collector-emitter breakdown voltage	$V_{CE}$		600	V
DC collector current	$I_C$	$T_j = T_{jmax}$ $T_s = 80^{\circ}\text{C}$ $T_c = 80^{\circ}\text{C}$	8 8	A
Repetitive peak collector current	$I_{CRM}$	$t_p$ limited by $T_{jmax}$	18	A
Turn off safe operating area		$V_{CE} \leq 1200\text{ V}$ , $T_j \leq T_{op\ max}$	18	A
Power dissipation	$P_{tot}$	$T_j = T_{jmax}$ $T_s = 80^{\circ}\text{C}$ $T_c = 80^{\circ}\text{C}$	36 54	W
Gate-emitter peak voltage	$V_{GE}$		$\pm 20$	V
Short circuit ratings	$t_{SC}$ $V_{CC}$	$T_j \leq 150^{\circ}\text{C}$ $V_{GE} = 15\text{ V}$	6 360	$\mu\text{s}$ V
Maximum Junction Temperature	$T_{jmax}$		175	$^{\circ}\text{C}$

**Brake Diode**

Peak Repetitive Reverse Voltage	$V_{RRM}$		600	V
DC forward current	$I_F$	$T_j = T_{jmax}$ $T_s = 80^{\circ}\text{C}$ $T_c = 80^{\circ}\text{C}$	8 8	A
Repetitive peak forward current	$I_{FRM}$	$t_p$ limited by $T_{jmax}$	12	A
Power dissipation	$P_{tot}$	$T_j = T_{jmax}$ $T_s = 80^{\circ}\text{C}$ $T_c = 80^{\circ}\text{C}$	27 40	W
Maximum Junction Temperature	$T_{jmax}$		175	$^{\circ}\text{C}$

**Thermal Properties**

Storage temperature	$T_{stg}$		-40...+125	$^{\circ}\text{C}$
Operation temperature under switching condition	$T_{op}$		-40...+( $T_{jmax} - 25$ )	$^{\circ}\text{C}$

**Isolation Properties**

Isolation voltage	$V_{is}$	$t = 2\text{ s}$ DC voltage	4000	V
Creepage distance			min 12,7	mm
Clearance		12 mm housing	9,29	mm
		17 mm housing	min 12,7	mm
Comparative tracking index	CTI		>200	



### Characteristic Values

Parameter	Symbol	Conditions					Value			Unit
		$V_{GE}$ [V] or $V_{GS}$ [V]	$V_r$ [V] or $V_{CE}$ [V] or $V_{DS}$ [V]	$I_C$ [A] or $I_F$ [A] or $I_D$ [A]	$T_j$ [°C]	Min	Typ	Max		

#### Rectifier Diode

Forward voltage	$V_F$				30	25 125	0,8	1,26 1,24	1,45	V
Threshold voltage (for power loss calc. only)	$V_{to}$				30	25 125		0,92 0,82		V
Slope resistance (for power loss calc. only)	$r_t$				30	25 125		11 14		mΩ
Reverse current	$I_r$			1500		145			1,1	mA
Thermal resistance junction to sink	$R_{th(j-s)}$	$\lambda_{paste} = 3,4$ W/mK (PSX)						1,61		K/W

#### Inverter Switch

Gate emitter threshold voltage	$V_{GE(th)}$	$V_{CE} = V_{GE}$				0,00015	25	5	5,8	6,5	V
Collector-emitter saturation voltage	$V_{CE(sat)}$		15		10	25 125	1	1,59 1,78	2,2		V
Collector-emitter cut-off current incl. Diode	$I_{CES}$		0	600		25			0,08		mA
Gate-emitter leakage current	$I_{GES}$		20	0		25			350		nA
Integrated Gate resistor	$R_{gint}$							none			Ω
Turn-on delay time	$t_{d(on)}$	$R_{gon} = 16$ Ω $R_{goff} = 32$ Ω	±15	300	10	25		15			ns
Rise time	$t_r$					125		14			
Turn-off delay time	$t_{d(off)}$					25		11			
Fall time	$t_f$					125		14			
Turn-on energy loss	$E_{on}$					25		155			
Turn-off energy loss	$E_{off}$	125		170		25		89	mWs		
Input capacitance	$C_{ies}$					125		98			
Output capacitance	$C_{oss}$	$f = 1$ MHz	0	25		25		0,16 0,22			
Reverse transfer capacitance	$C_{rss}$							0,24 0,29			
Gate charge	$Q_G$		±15	480	10	25		62		nC	
Thermal resistance junction to sink	$R_{th(j-s)}$	$\lambda_{paste} = 3,4$ W/mK (PSX)						2,15		K/W	

#### Inverter Diode

Diode forward voltage	$V_F$				10	25 125	1	1,61 1,51	2,25		V
Peak reverse recovery current	$I_{RRM}$	$R_{gon} = 32$ Ω	±15	300	10	25		10			A
Reverse recovery time	$t_{rr}$					125		11			
Reverse recovered charge	$Q_{rr}$					25		142			
Peak rate of fall of recovery current	$(di_{rr}/dt)_{max}$					125		219			
Reverse recovered energy	$E_{rec}$					25		0,46			
Thermal resistance junction to sink	$R_{th(j-s)}$	$\lambda_{paste} = 3,4$ W/mK (PSX)						0,80		μC	
						25		703		A/μs	
						125		397		mWs	
						25		0,09		K/W	
						125		0,17			



### Characteristic Values

Parameter	Symbol	Conditions					Value			Unit
		$V_{GE}$ [V] or $V_{GS}$ [V]	$V_{CE}$ [V] or $V_{DS}$ [V]	$I_C$ [A] or $I_F$ [A] or $I_D$ [A]	$T_j$ [°C]	Min	Typ	Max		

#### Brake Switch

Gate emitter threshold voltage	$V_{GE(th)}$	$V_{CE} = V_{GE}$			0,00043	25	5	5,8	6,5	V
Collector-emitter saturation voltage	$V_{CE(sat)}$		15		6	25 125	1	1,55 1,72	2,1	V
Collector-emitter cut-off incl diode	$I_{CES}$		0	600		25			0,06	mA
Gate-emitter leakage current	$I_{GES}$		20	0		25			350	nA
Integrated Gate resistor	$R_{gint}$							none		$\Omega$
Turn-on delay time	$t_{d(on)}$					25 125		11 10		ns
Rise time	$t_r$					25 125		8 10		
Turn-off delay time	$t_{d(off)}$	$R_{goff} = 16 \Omega$ $R_{gonn} = 32 \Omega$	$\pm 15$	300	6	25 125		118 130		
Fall time	$t_f$					25 125		93 117		
Turn-on energy loss	$E_{on}$					25 125		0,07 0,10		mWs
Turn-off energy loss	$E_{off}$					25 125		0,15 0,18		
Input capacitance	$C_{ies}$							368		pF
Output capacitance	$C_{oss}$	$f = 1 \text{ MHz}$	0	25		25		28		
Reverse transfer capacitance	$C_{rss}$							11		
Gate charge	$Q_G$					25		42		nC
Thermal resistance junction to sink	$R_{th(j-s)}$	$\lambda_{paste} = 3,4 \text{ W/mK}$ (PSX)						2,44		K/W

#### Brake Diode

Diode forward voltage	$V_F$				6	25 125	1	1,69 1,61	2,5	V
Reverse leakage current	$I_r$			600		25			60	$\mu\text{A}$
Peak reverse recovery current	$I_{RRM}$					25 125		7 8		A
Reverse recovery time	$t_{rr}$					25 125		97 151		ns
Reverse recovered charge	$Q_{rr}$	$R_{gonn} = 32 \Omega$	$\pm 15$	300	6	25 125		0,23 0,23		$\mu\text{C}$
Peak rate of fall of recovery current	$(di_{rr}/dt)_{max}$					25 125		522 321		A/ $\mu\text{s}$
Reverse recovery energy	$E_{rec}$					25 125		0,05 0,09		mWs
Thermal resistance junction to sink	$R_{th(j-s)}$	$\lambda_{paste} = 3,4 \text{ W/mK}$ (PSX)						2,68		K/W

#### Thermistor

Rated resistance	$R$					25		22000		$\Omega$
Deviation of R100	$\Delta_{R/R}$	$R_{100} = 1486 \Omega$				100	-5		5	%
Power dissipation	$P$					25		210		mW
Power dissipation constant						25		3,5		mW/K
B-value	$B_{(25/50)}$	Tol. $\pm 3 \%$				25				K
B-value	$B_{(25/100)}$	Tol. $\pm 3 \%$				25		4000		K
Vincotech NTC Reference						25			A	



### Inverter Characteristics

**Figure 1** Inverter IGBT

Typical output characteristics

$I_C = f(V_{CE})$

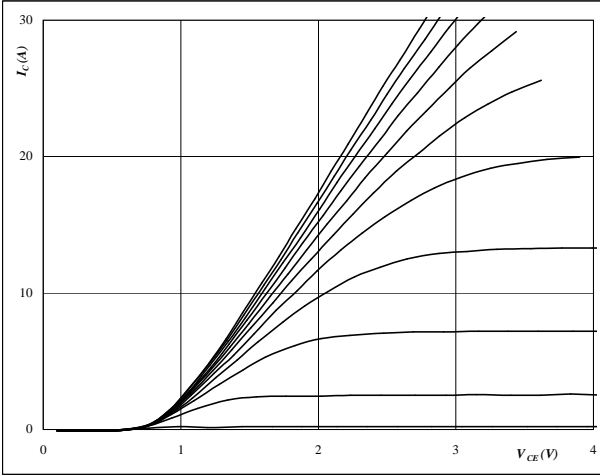

**At**

$t_p = 250 \mu s$   
 $T_j = 25 \text{ } ^\circ C$   
 $V_{GE}$  from 7 V to 17 V in steps of 1 V

**Figure 2** Inverter IGBT

Typical output characteristics

$I_C = f(V_{CE})$

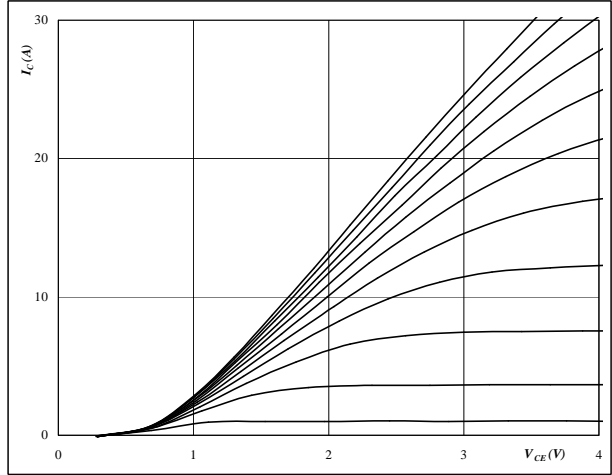

**At**

$t_p = 250 \mu s$   
 $T_j = 125 \text{ } ^\circ C$   
 $V_{GE}$  from 7 V to 17 V in steps of 1 V

**Figure 3** Inverter IGBT

Typical transfer characteristics

$I_C = f(V_{GE})$

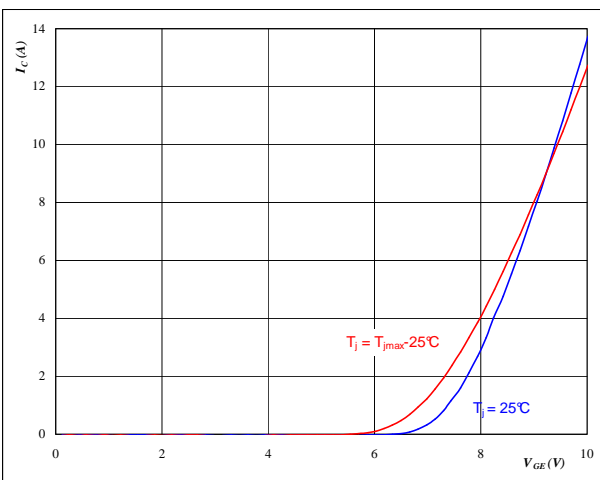

**At**

$t_p = 250 \mu s$   
 $V_{CE} = 10 V$

**Figure 4** Inverter FWD

Typical diode forward current as a function of forward voltage

$I_F = f(V_F)$

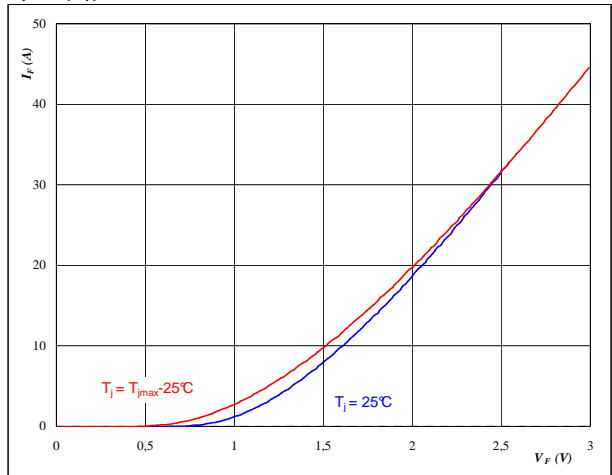

**At**

$t_p = 250 \mu s$



### Inverter Characteristics

**Figure 5** Inverter IGBT

Typical switching energy losses  
as a function of collector current

$E = f(I_C)$

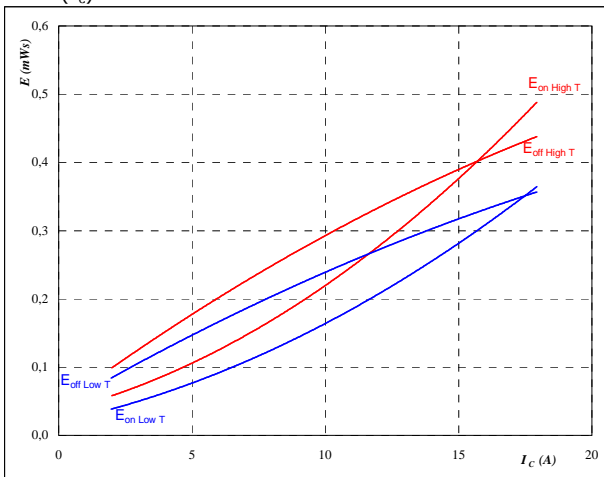

With an inductive load at

- $T_j = 25/125$  °C
- $V_{CE} = 300$  V
- $V_{GE} = 15$  V
- $R_{gon} = 32$  Ω
- $R_{goff} = 16$  Ω

**Figure 6** Inverter IGBT

Typical switching energy losses  
as a function of gate resistor

$E = f(R_G)$

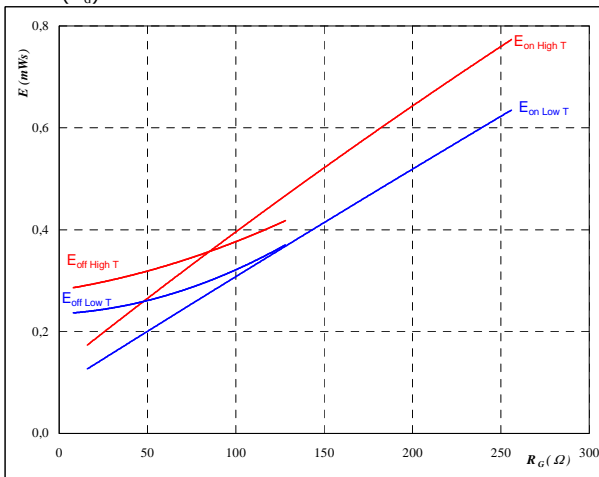

With an inductive load at

- $T_j = 25/125$  °C
- $V_{CE} = 300$  V
- $V_{GE} = 15$  V
- $I_C = 10$  A

**Figure 7** Inverter FWD

Typical reverse recovery energy loss  
as a function of collector current

$E_{rec} = f(I_C)$

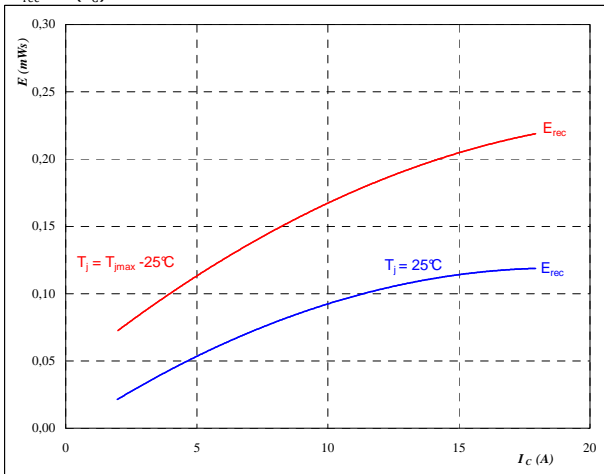

With an inductive load at

- $T_j = 25/125$  °C
- $V_{CE} = 300$  V
- $V_{GE} = 15$  V
- $R_{gon} = 32$  Ω

**Figure 8** Inverter FWD

Typical reverse recovery energy loss  
as a function of gate resistor

$E_{rec} = f(R_G)$

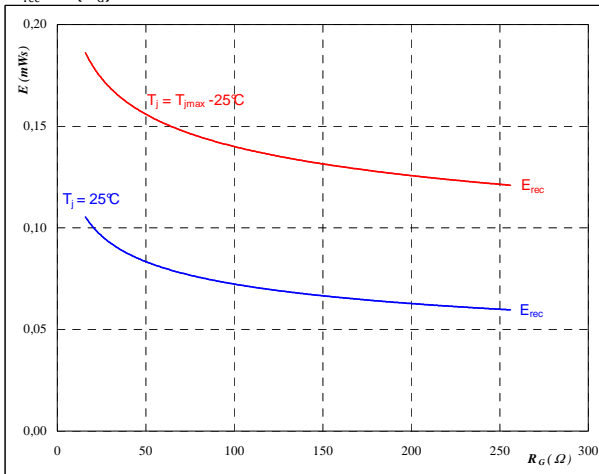

With an inductive load at

- $T_j = 25/125$  °C
- $V_{CE} = 300$  V
- $V_{GE} = 15$  V
- $I_C = 10$  A



### Inverter Characteristics

**Figure 9** Inverter IGBT

Typical switching times as a function of collector current

$t = f(I_C)$

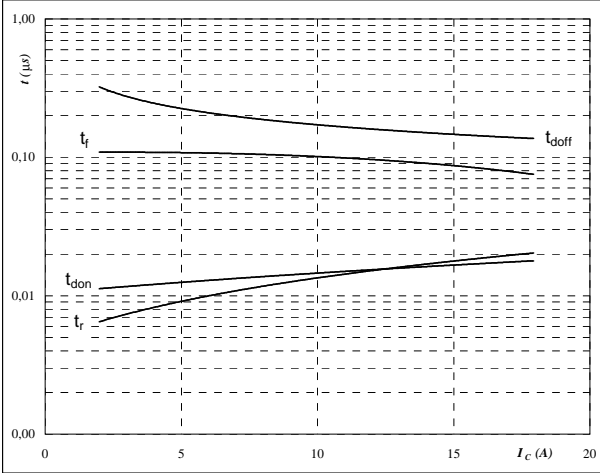

With an inductive load at

$T_j =$	125	°C
$V_{CE} =$	300	V
$V_{GE} =$	15	V
$R_{gon} =$	32	Ω
$R_{goff} =$	16	Ω

**Figure 10** Inverter IGBT

Typical switching times as a function of gate resistor

$t = f(R_G)$

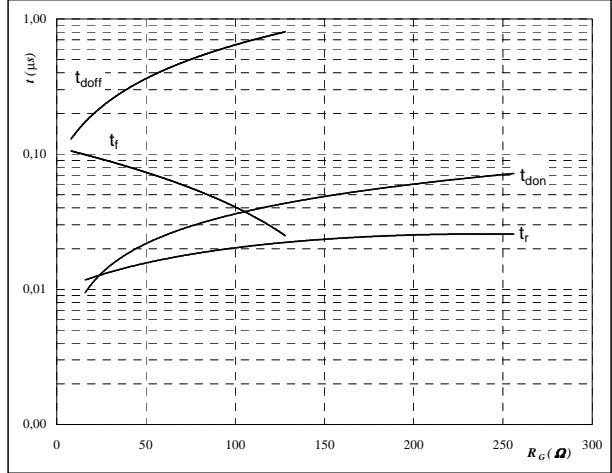

With an inductive load at

$T_j =$	125	°C
$V_{CE} =$	300	V
$V_{GE} =$	15	V
$I_C =$	10	A

**Figure 11** Inverter FWD

Typical reverse recovery time as a function of collector current

$t_{rr} = f(I_C)$

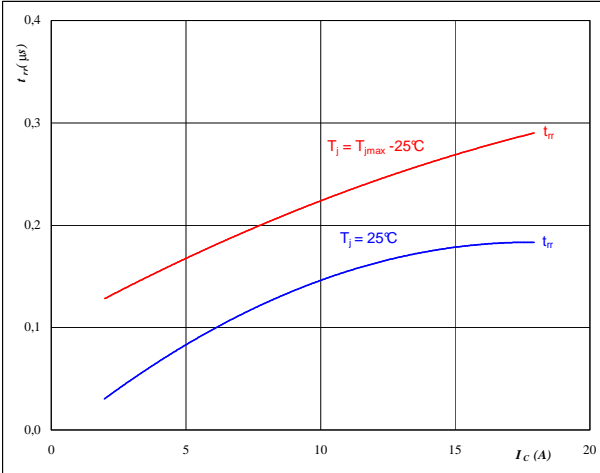

At

$T_j =$	25/125	°C
$V_{CE} =$	300	V
$V_{GE} =$	15	V
$R_{gon} =$	32	Ω

**Figure 12** Inverter FWD

Typical reverse recovery time as a function of IGBT turn on gate resistor

$t_{rr} = f(R_{gon})$

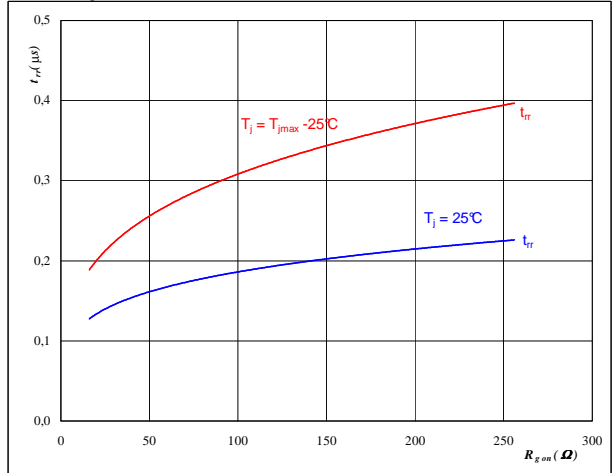

At

$T_j =$	25/125	°C
$V_R =$	300	V
$I_F =$	10	A
$V_{GE} =$	15	V



## Inverter Characteristics

Figure 13 Inverter FWD

Typical reverse recovery charge as a function of collector current

$$Q_{rr} = f(I_C)$$

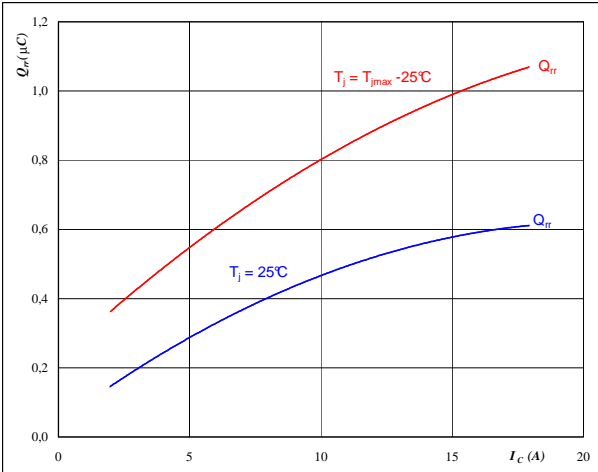

At

$T_j =$	25/125	°C
$V_{CE} =$	300	V
$V_{GE} =$	15	V
$R_{gon} =$	32	Ω

Figure 14 Inverter FWD

Typical reverse recovery charge as a function of IGBT turn on gate resistor

$$Q_{rr} = f(R_{gon})$$

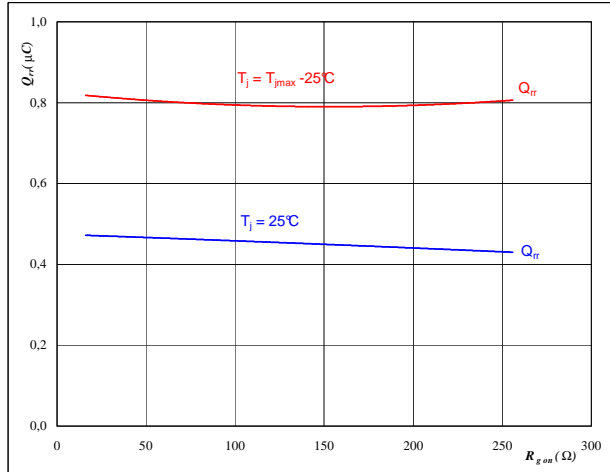

At

$T_j =$	25/125	°C
$V_R =$	300	V
$I_F =$	10	A
$V_{GE} =$	15	V

Figure 15 Inverter FWD

Typical reverse recovery current as a function of collector current

$$I_{RRM} = f(I_C)$$

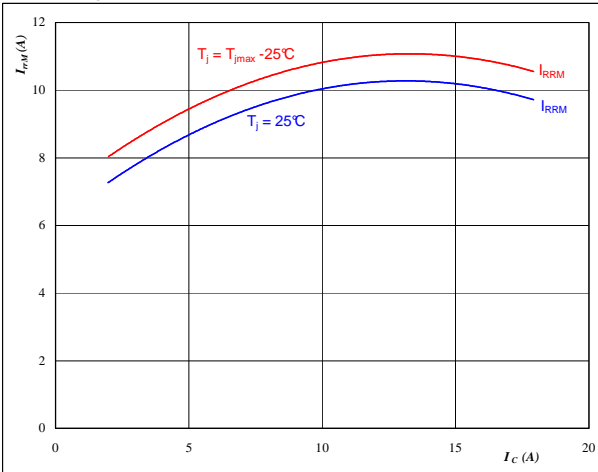

At

$T_j =$	25/125	°C
$V_{CE} =$	300	V
$V_{GE} =$	15	V
$R_{gon} =$	32	Ω

Figure 16 Inverter FWD

Typical reverse recovery current as a function of IGBT turn on gate resistor

$$I_{RRM} = f(R_{gon})$$

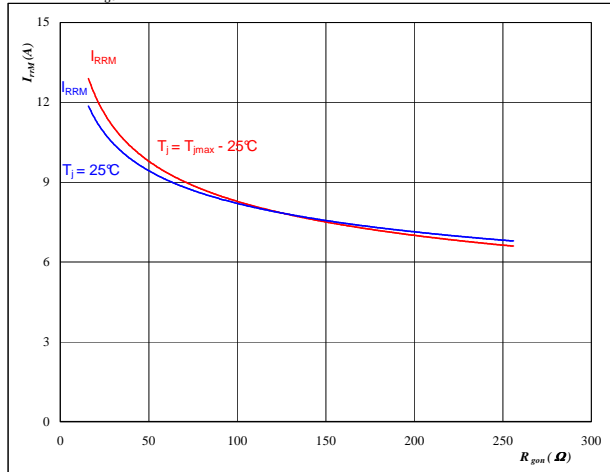

At

$T_j =$	25/125	°C
$V_R =$	300	V
$I_F =$	10	A
$V_{GE} =$	15	V





## Inverter Characteristics

**Figure 17** Inverter FWD

**Typical rate of fall of forward and reverse recovery current as a function of collector current**

$$dI_0/dt, dI_{rec}/dt = f(I_C)$$

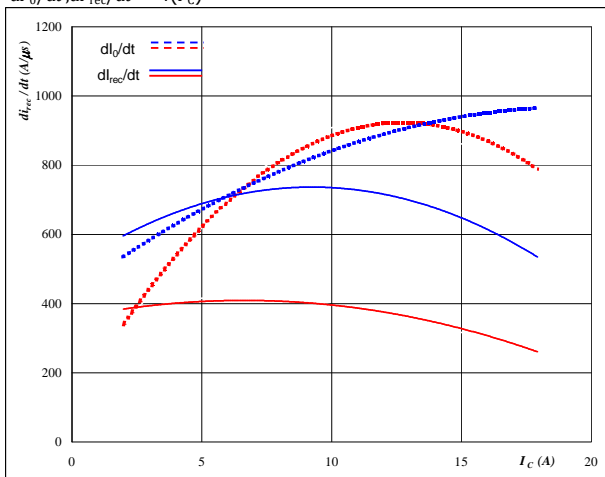

**At**  
 $T_j = 25/125$  °C  
 $V_{CE} = 300$  V  
 $V_{GE} = 15$  V  
 $R_{gon} = 32$  Ω

**Figure 18** Inverter FWD

**Typical rate of fall of forward and reverse recovery current as a function of IGBT turn on gate resistor**

$$dI_0/dt, dI_{rec}/dt = f(R_{gon})$$

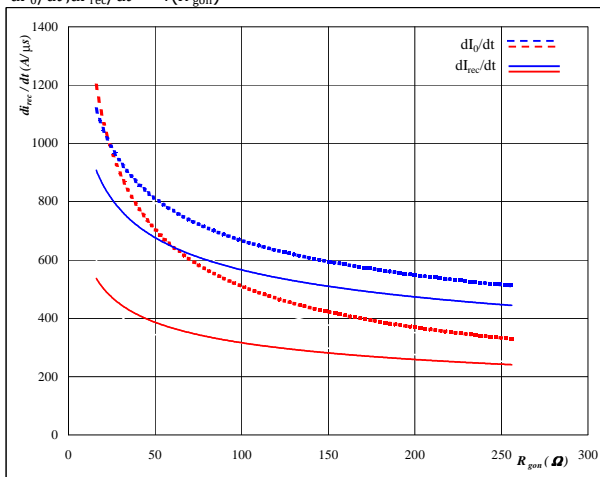

**At**  
 $T_j = 25/125$  °C  
 $V_R = 300$  V  
 $I_F = 10$  A  
 $V_{GE} = 15$  V

**Figure 19** Inverter IGBT

**IGBT transient thermal impedance as a function of pulse width**

$$Z_{th(j-s)} = f(t_p)$$

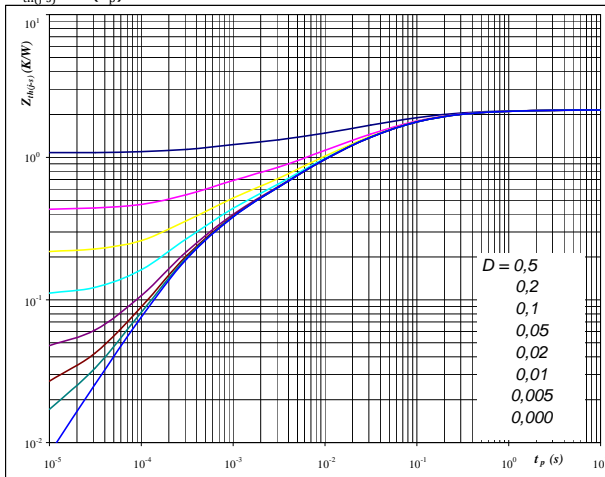

**At**  
 $D = t_p / T$   
 $R_{th(j-s)} = 2,15$  K/W

IGBT thermal model values

R (K/W)	Tau (s)
1,04E-01	5,21E+00
2,88E-01	5,04E-01
6,99E-01	1,01E-01
4,91E-01	1,86E-02
3,07E-01	3,43E-03
2,60E-01	3,51E-04

**Figure 20** Inverter FWD

**FWD transient thermal impedance as a function of pulse width**

$$Z_{th(j-s)} = f(t_p)$$

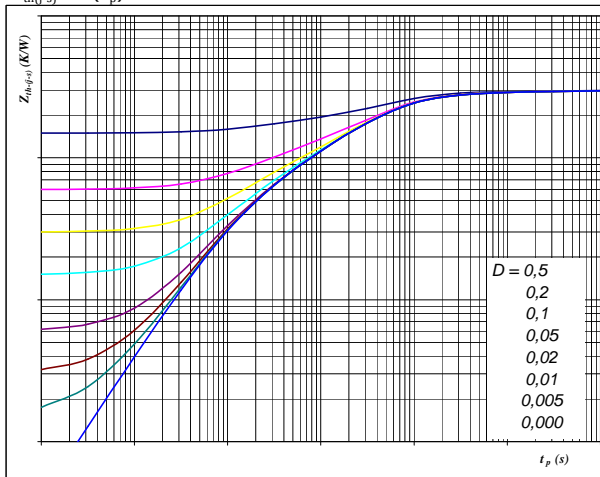

**At**  
 $D = t_p / T$   
 $R_{th(j-s)} = 2,98$  K/W

FWD thermal model values

R (K/W)	Tau (s)
8,74E-02	8,15E+00
2,41E-01	5,25E-01
1,22E+00	9,35E-02
6,89E-01	2,02E-02
4,52E-01	3,19E-03
2,99E-01	4,10E-04



### Inverter Characteristics

**Figure 25** Inverter IGBT

Safe operating area as a function of collector-emitter voltage

$I_C = f(V_{CE})$

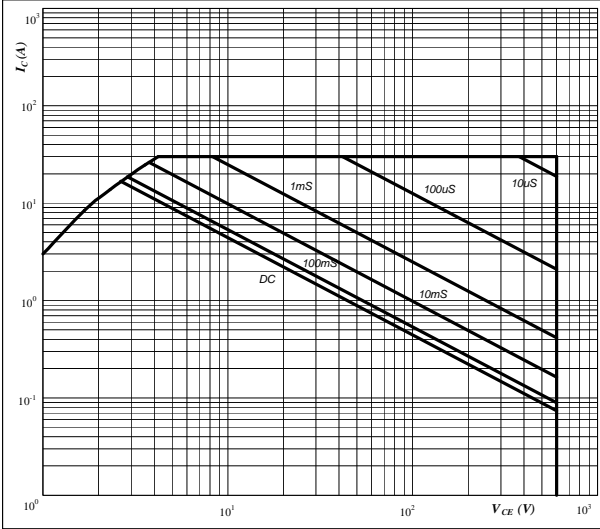

**At**  
 $D =$  single pulse  
 $T_s =$  80 °C  
 $V_{GE} =$  15 V  
 $T_j = T_{jmax}$  °C

**Figure 26** Inverter IGBT

Gate voltage vs Gate charge

$V_{GE} = f(Q_g)$

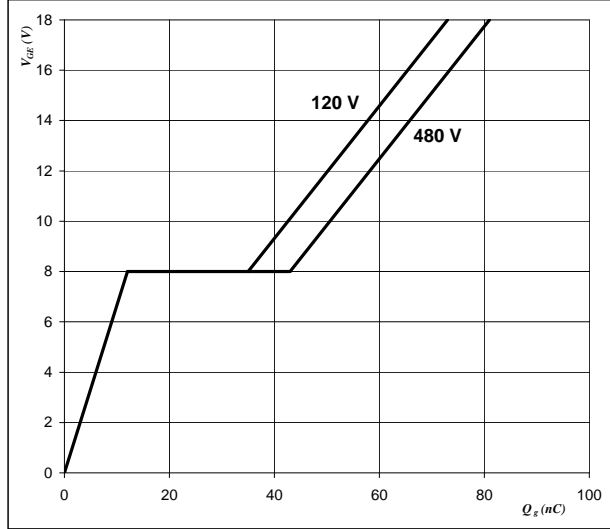

**At**  
 $I_C =$  10 A

**Figure 27** Inverter IGBT

Short circuit withstand time as a function of gate-emitter voltage

$t_{sc} = f(V_{GE})$

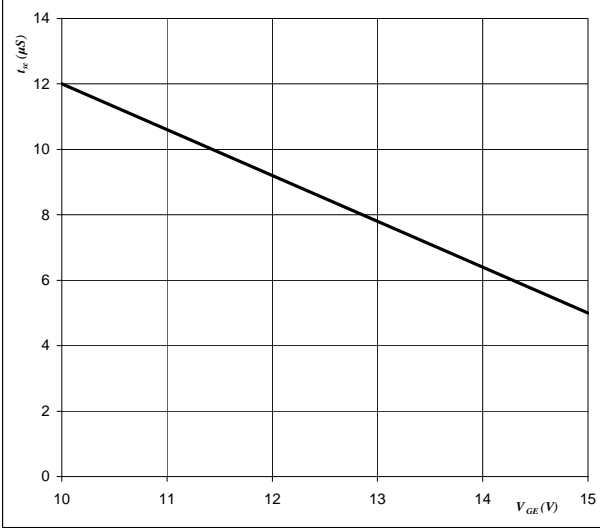

**At**  
 $V_{CE} =$  600 V  
 $T_j \leq$  175 °C

**Figure 28** Inverter IGBT

Typical short circuit collector current as a function of gate-emitter voltage

$V_{GE} = f(Q_{GE})$

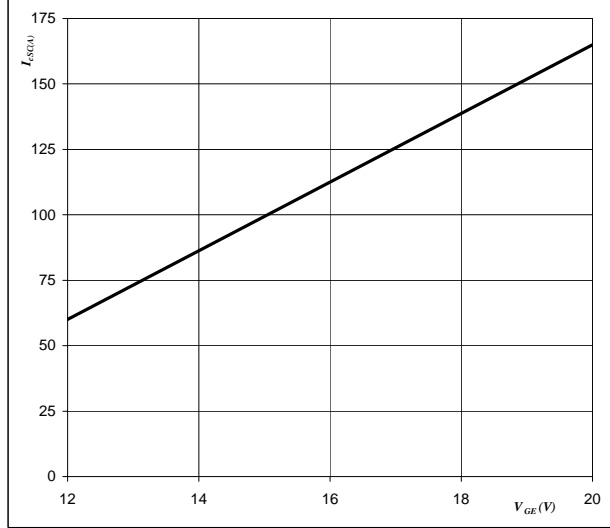

**At**  
 $V_{CE} \leq$  600 V  
 $T_j =$  175 °C



### Inverter Characteristics

**Figure 29** Inverter IGBT  
**Reverse bias safe operating area**

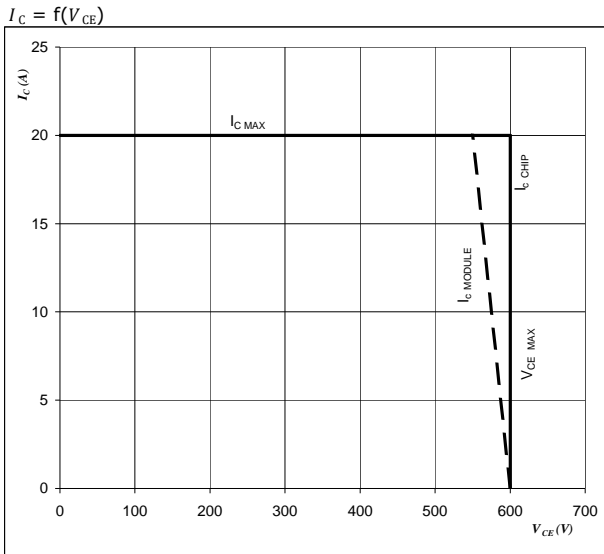

**At**  
 $T_j = T_{jmax} - 25 \text{ } ^\circ\text{C}$



### Brake Characteristics

**Figure 1** Brake IGBT

Typical output characteristics

$I_C = f(V_{CE})$

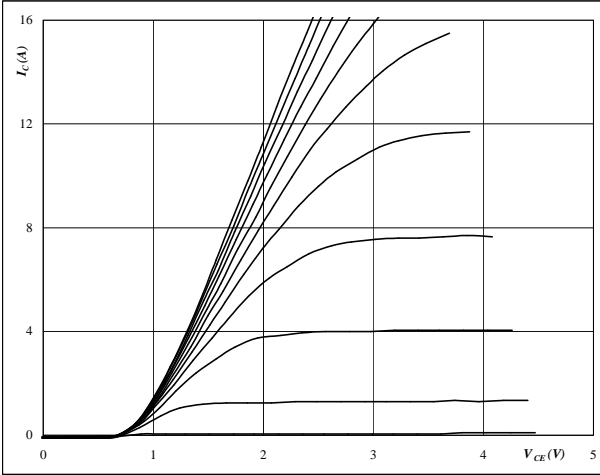

**At**  
 $t_p = 250 \mu s$   
 $T_j = 25 \text{ } ^\circ C$   
 $V_{GE}$  from 7 V to 17 V in steps of 1 V

**Figure 2** Brake IGBT

Typical output characteristics

$I_C = f(V_{CE})$

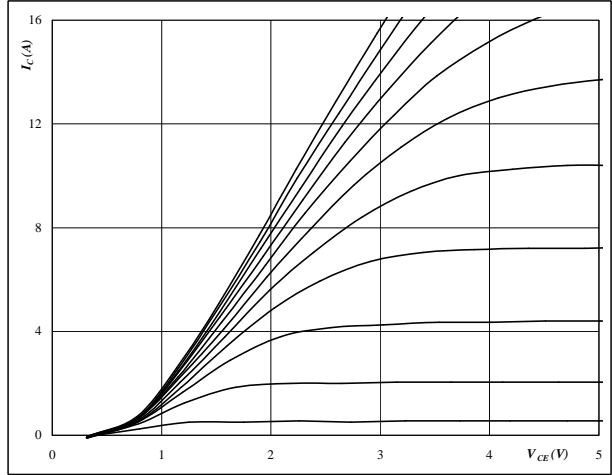

**At**  
 $t_p = 250 \mu s$   
 $T_j = 125 \text{ } ^\circ C$   
 $V_{GE}$  from 7 V to 17 V in steps of 1 V

**Figure 3** Brake IGBT

Typical transfer characteristics

$I_C = f(V_{GE})$

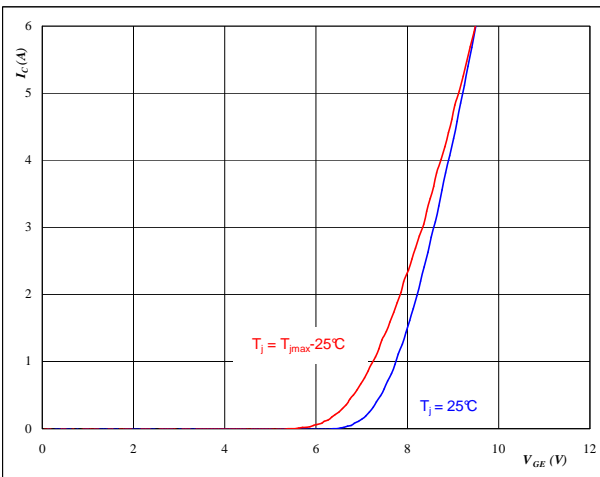

**At**  
 $t_p = 250 \mu s$   
 $V_{CE} = 10 V$

**Figure 4** Brake FWD

Typical diode forward current as a function of forward voltage

$I_F = f(V_F)$

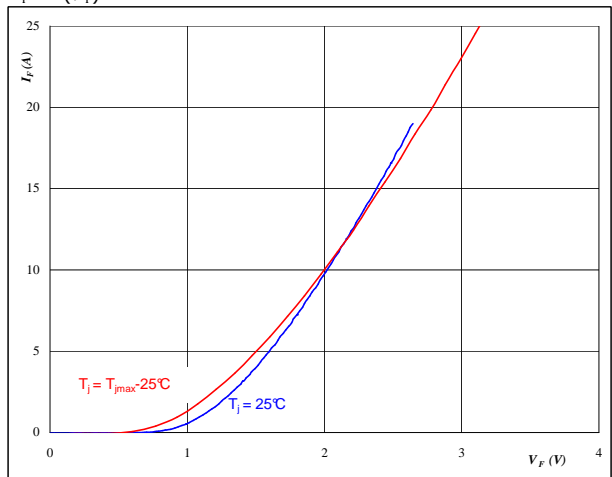

**At**  
 $t_p = 250 \mu s$



### Brake Characteristics

**Figure 5** Brake IGBT

Typical switching energy losses  
as a function of collector current

$E = f(I_C)$

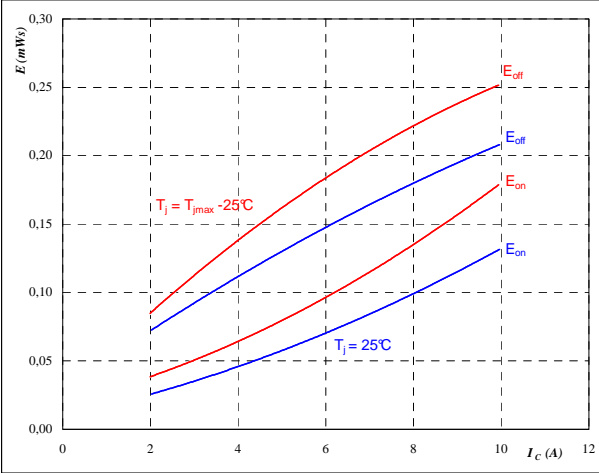

With an inductive load at

- $T_j = 25/125$  °C
- $V_{CE} = 300$  V
- $V_{GE} = 15$  V
- $R_{gon} = 32$  Ω
- $R_{goff} = 16$  Ω

**Figure 6** Brake IGBT

Typical switching energy losses  
as a function of gate resistor

$E = f(R_G)$

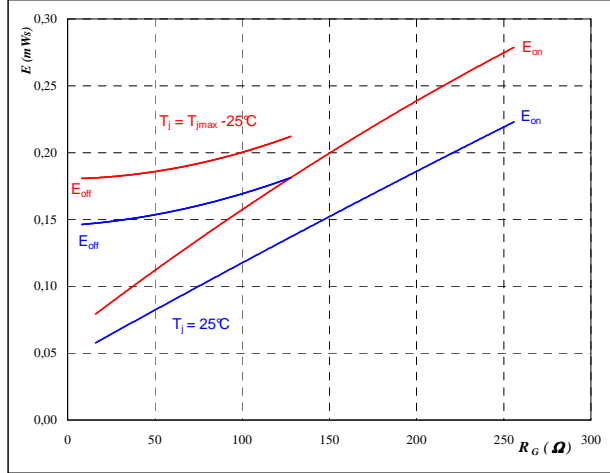

With an inductive load at

- $T_j = 25/125$  °C
- $V_{CE} = 300$  V
- $V_{GE} = 15$  V
- $I_C = 6$  A

**Figure 7** Brake FWD

Typical reverse recovery energy loss  
as a function of collector current

$E_{rec} = f(I_C)$

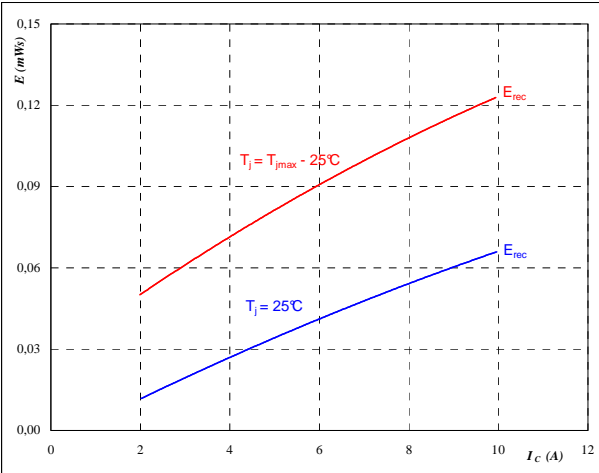

With an inductive load at

- $T_j = 25/125$  °C
- $V_{CE} = 300$  V
- $V_{GE} = 15$  V
- $R_{gon} = 32$  Ω

**Figure 8** Brake FWD

Typical reverse recovery energy loss  
as a function of gate resistor

$E_{rec} = f(R_G)$

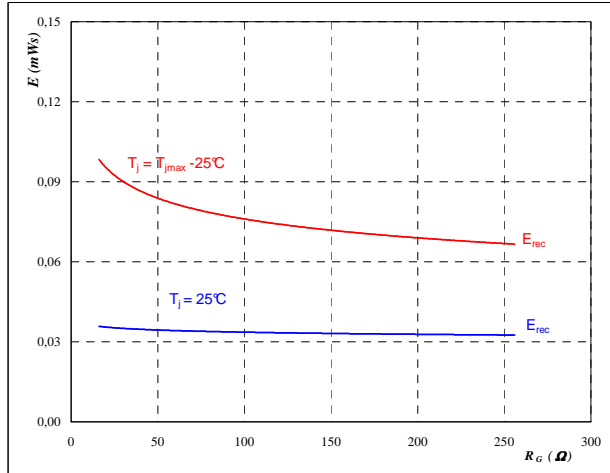

With an inductive load at

- $T_j = 25/125$  °C
- $V_{CE} = 300$  V
- $V_{GE} = 15$  V
- $I_C = 6$  A



### Brake Characteristics

**Figure 9** Brake IGBT

Typical switching times as a function of collector current

$t = f(I_C)$

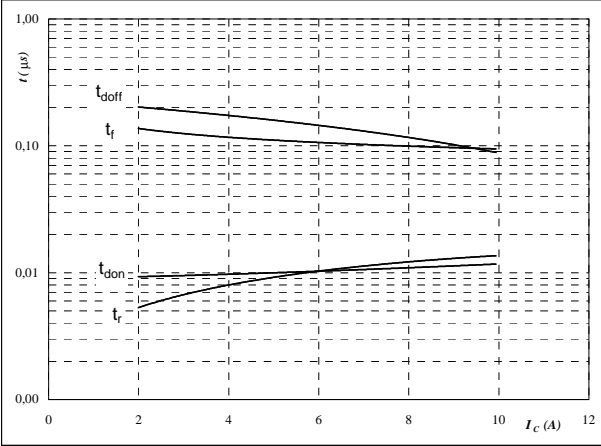

With an inductive load at

- $T_j = 125 \text{ } ^\circ\text{C}$
- $V_{CE} = 300 \text{ V}$
- $V_{GE} = 15 \text{ V}$
- $R_{gon} = 32 \text{ } \Omega$
- $R_{goff} = 16 \text{ } \Omega$

**Figure 10** Brake IGBT

Typical switching times as a function of gate resistor

$t = f(R_G)$

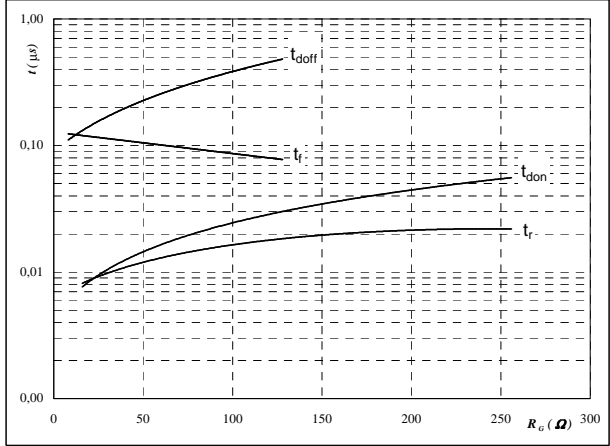

With an inductive load at

- $T_j = 125 \text{ } ^\circ\text{C}$
- $V_{CE} = 300 \text{ V}$
- $V_{GE} = 15 \text{ V}$
- $I_C = 6 \text{ A}$

**Figure 11** Brake IGBT

IGBT transient thermal impedance as a function of pulse width

$Z_{th(j-s)} = f(t_p)$

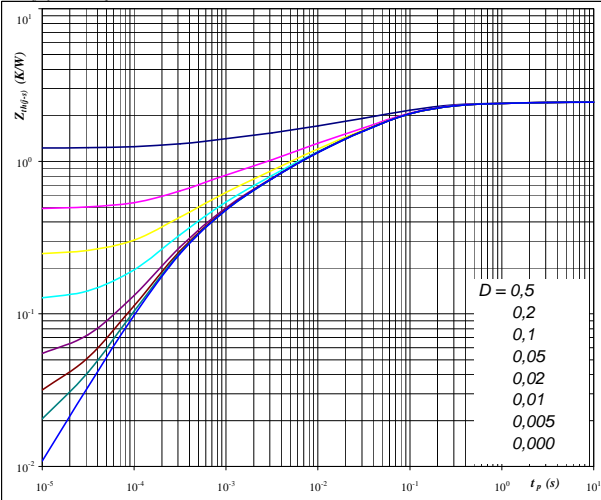

At

- $D = t_p / T$
- $R_{th(j-s)} = 2,44 \text{ K/W}$

**Figure 12** Brake FWD

FWD transient thermal impedance as a function of pulse width

$Z_{th(j-s)} = f(t_p)$

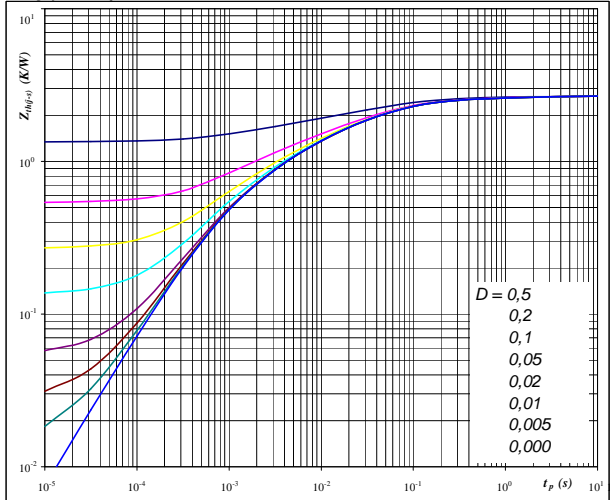

At

- $D = t_p / T$
- $R_{th(j-s)} = 2,68 \text{ K/W}$



### Rectifier Diode Characteristics

**Figure 1** Rectifier diode

Typical diode forward current as a function of forward voltage

$I_F = f(V_F)$

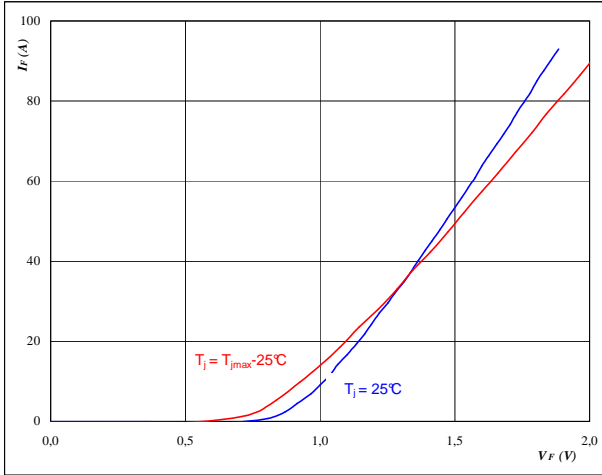

**At**  
 $t_p = 250 \mu s$

**Figure 2** Rectifier diode

Diode transient thermal impedance as a function of pulse width

$Z_{th(j-s)} = f(t_p)$

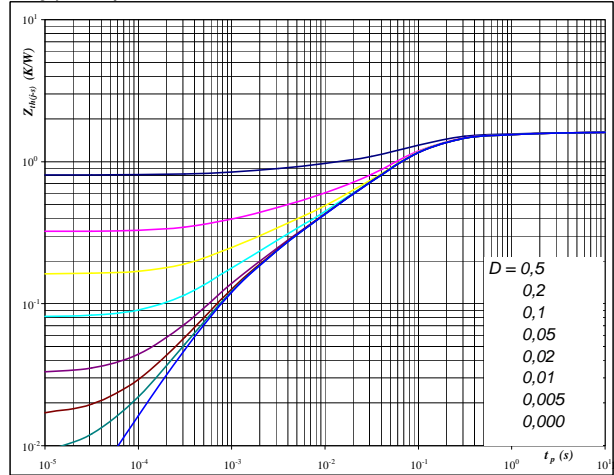

**At**  
 $D = t_p / T$   
 $R_{th(j-s)} = 1,61 \text{ K/W}$

### Thermistor Characteristics

**Figure 1** Thermistor

Typical NTC characteristic as a function of temperature

$R_T = f(T)$

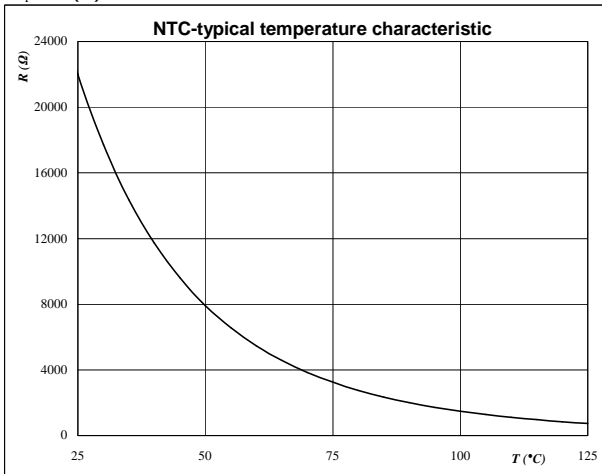



## Switching Definitions Inverter

### General conditions

$T_j$	=	125 °C
$R_{gon}$	=	32 $\Omega$
$R_{goff}$	=	16 $\Omega$

**Figure 1** Inverter IGBT

Turn-off Switching Waveforms & definition of  $t_{doff}$ ,  $t_{Eoff}$   
( $t_{Eoff}$  = integrating time for  $E_{off}$ )

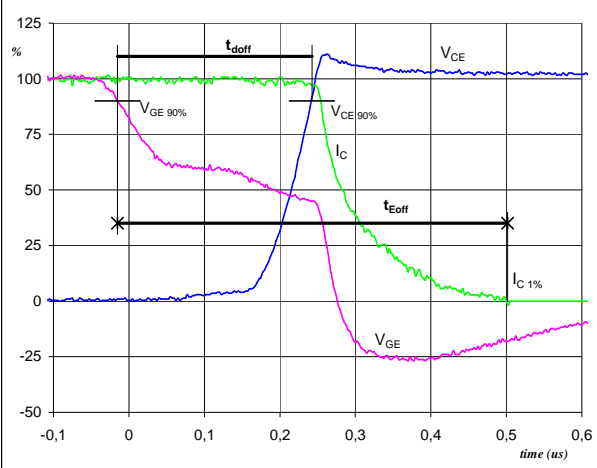

$V_{GE}$ (0%) =	0	V
$V_{GE}$ (100%) =	15	V
$V_C$ (100%) =	300	V
$I_C$ (100%) =	10	A
$t_{doff}$ =	0,26	$\mu$ s
$t_{Eoff}$ =	0,52	$\mu$ s

**Figure 2** Inverter IGBT

Turn-on Switching Waveforms & definition of  $t_{don}$ ,  $t_{Eon}$   
( $t_{Eon}$  = integrating time for  $E_{on}$ )

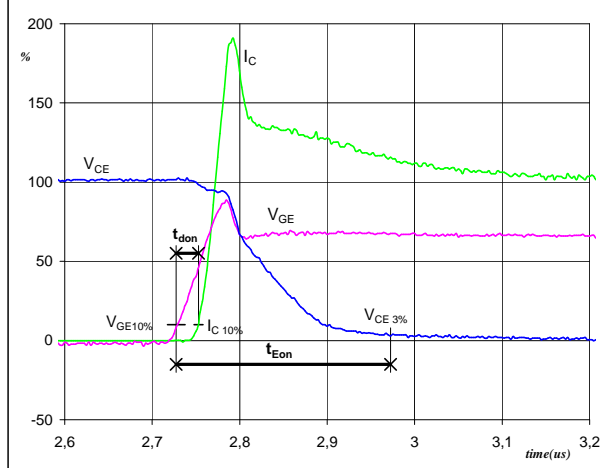

$V_{GE}$ (0%) =	0	V
$V_{GE}$ (100%) =	15	V
$V_C$ (100%) =	300	V
$I_C$ (100%) =	10	A
$t_{don}$ =	0,02	$\mu$ s
$t_{Eon}$ =	0,24	$\mu$ s

**Figure 3** Inverter IGBT

Turn-off Switching Waveforms & definition of  $t_f$

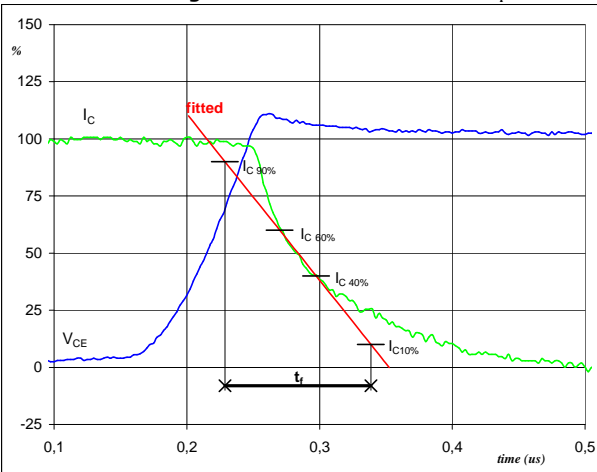

$V_C$ (100%) =	300	V
$I_C$ (100%) =	10	A
$t_f$ =	0,10	$\mu$ s

**Figure 4** Inverter IGBT

Turn-on Switching Waveforms & definition of  $t_r$

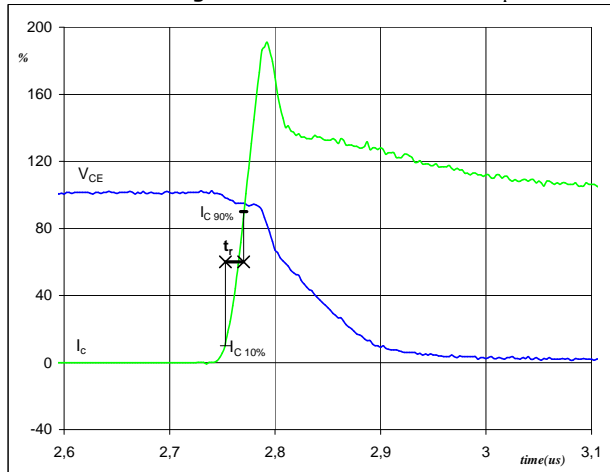

$V_C$ (100%) =	300	V
$I_C$ (100%) =	10	A
$t_r$ =	0,02	$\mu$ s





### Switching Definitions Inverter

**Figure 5** Inverter IGBT

Turn-off Switching Waveforms & definition of  $t_{Eoff}$

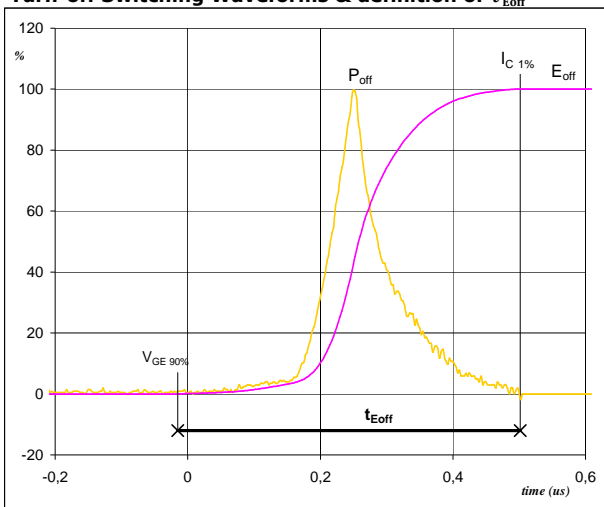

$P_{off}$ (100%) =	2,99	kW
$E_{off}$ (100%) =	0,30	mJ
$t_{Eoff}$ =	0,52	$\mu$ s

**Figure 6** Inverter IGBT

Turn-on Switching Waveforms & definition of  $t_{Eon}$

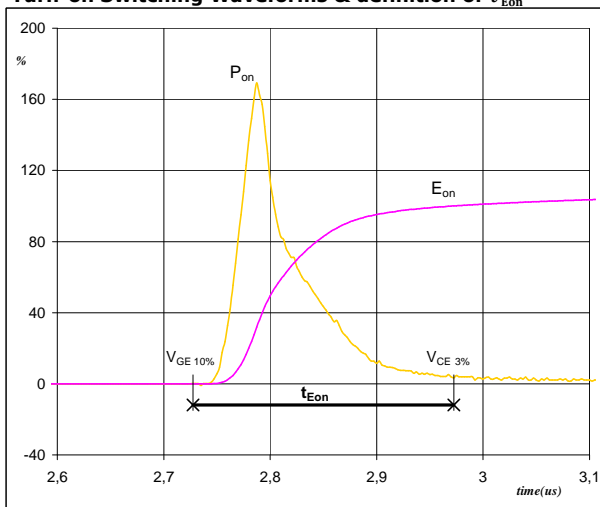

$P_{on}$ (100%) =	2,99	kW
$E_{on}$ (100%) =	0,31	mJ
$t_{Eon}$ =	0,24	$\mu$ s

**Figure 7** Inverter IGBT

Turn-off Switching Waveforms & definition of  $t_{rr}$

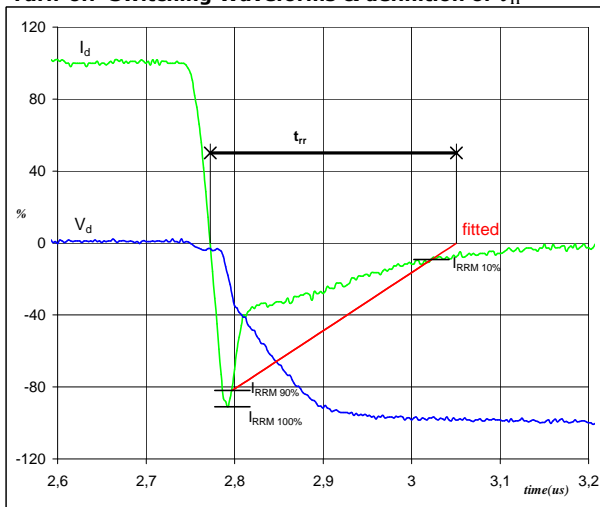

$V_d$ (100%) =	300	V
$I_d$ (100%) =	10	A
$I_{RRM}$ (100%) =	9	A
$t_{rr}$ =	0,26	$\mu$ s



### Switching Definitions Inverter

**Figure 8** Inverter FWD  
**Turn-on Switching Waveforms & definition of  $t_{Qrr}$**   
( $t_{Qrr}$  = integrating time for  $Q_{rr}$ )

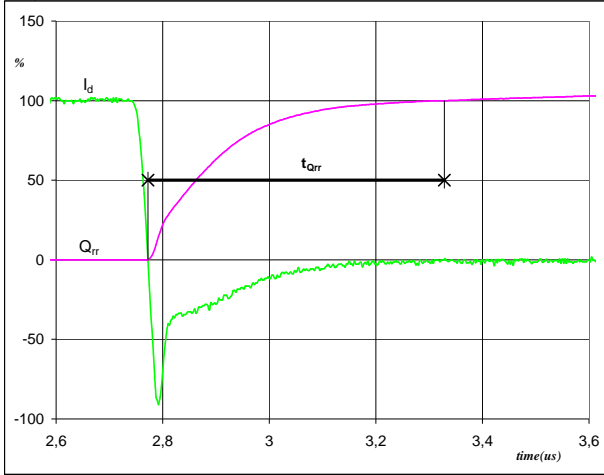

$I_d$ (100%) =	10	A
$Q_{rr}$ (100%) =	0,82	$\mu\text{C}$
$t_{Qrr}$ =	0,56	$\mu\text{s}$

**Figure 9** Inverter FWD  
**Turn-on Switching Waveforms & definition of  $t_{Erec}$**   
( $t_{Erec}$  = integrating time for  $E_{rec}$ )

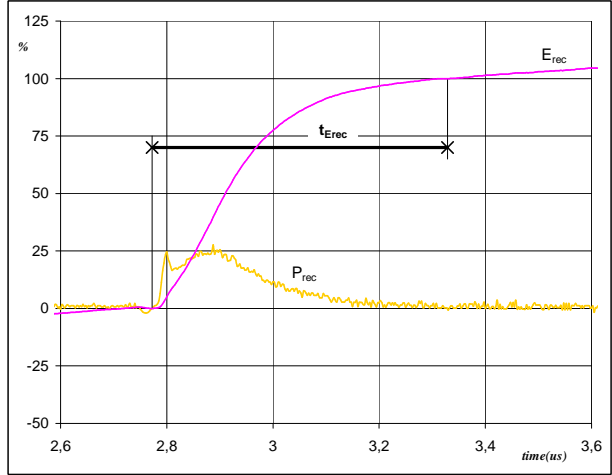

$P_{rec}$ (100%) =	2,99	kW
$E_{rec}$ (100%) =	0,16	mJ
$t_{Erec}$ =	0,56	$\mu\text{s}$



## Ordering Code and Marking - Outline - Pinout

Ordering Code & Marking								
Version			Ordering Code					
without thermal paste 12mm housing with solder pins			V23990-P543-A28-PM					
with thermal paste 12mm housing with solder pins			V23990-P543-A28-/3/-PM					
without thermal paste 17mm housing with solder pins			V23990-P543-A29-PM					
with thermal paste 17mm housing with solder pins			V23990-P543-A29-/3/-PM					
without thermal paste 1 phase rectifier 12mm housing with solder pins			V23990-P543-B28-PM					
with thermal paste 1 phase rectifier 12mm housing with solder pins			V23990-P543-B28-/3/-PM					
without thermal paste 1 phase rectifier 12mm housing with solder pins			V23990-P543-B128-PM					
with thermal paste 1 phase rectifier 12mm housing with solder pins			V23990-P543-B128-/3/-PM					
without thermal paste 1 phase rectifier 17mm housing with solder pins			V23990-P543-B129-PM					
with thermal paste 1 phase rectifier 17mm housing with solder pins			V23990-P543-B129-/3/-PM					
without thermal paste without brake 12mm housing with solder pins			V23990-P543-C28-PM					
with thermal paste without brake 12mm housing with solder pins			V23990-P543-C28-/3/-PM					
without thermal paste without brake 17mm housing with solder pins			V23990-P543-C29-PM					
with thermal paste without brake 17mm housing with solder pins			V23990-P543-C29-/3/-PM					
without thermal paste without brake 1 phase rectifier 12mm housing with solder pins			V23990-P543-D28-PM					
with thermal paste without brake 1 phase rectifier 12mm housing with solder pins			V23990-P543-D28-/3/-PM					
without thermal paste without brake 1 phase rectifier 17mm housing with solder pins			V23990-P543-D129-PM					
with thermal paste without brake 1 phase rectifier 17mm housing with solder pins			V23990-P543-D129-/3/-PM					
		Text	VIN	Date code	Name&Ver	UL	Lot	Serial
			VIN	WWYY	NNNNNVV	UL	LLLLL	SSSS
		Datamatrix	Type&Ver	Lot number	Serial	Date code		
			TTTTTVV	LLLLL	SSSS	WWYY		

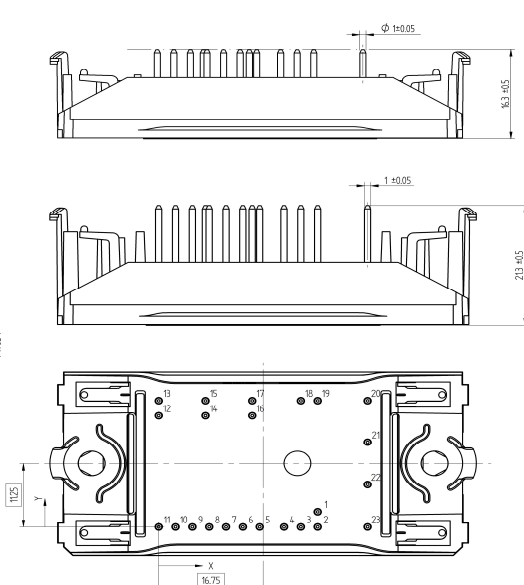
Pin table			Outline		Pinout variation	
Pin	X	Y			Modul subtype	Not assembled pins
1	25,5	2,7			P543-A2x	-
2	25,5	0			P543-B2x	21
3	22,8	0			P543-B12x	23
4	20,1	0			P543-C2x	4,5,20
5	16,2	0			P543-D2x	4,5,20,21
6	13,5	0			P543-D12x	4,5,20,23
7	10,8	0				
8	8,1	0				
9	5,4	0				
10	2,7	0				
11	0	0				
12	0	19,8				
13	0	22,5				
14	7,5	19,8				
15	7,5	22,5				
16	15	19,8				
17	15	22,5				
18	22,8	22,5				
19	25,5	22,5				
20	33,5	22,5				
21	33,5	15				
22	33,5	7,5				
23	33,5	0				



### Ordering Code and Marking - Outline - Pinout

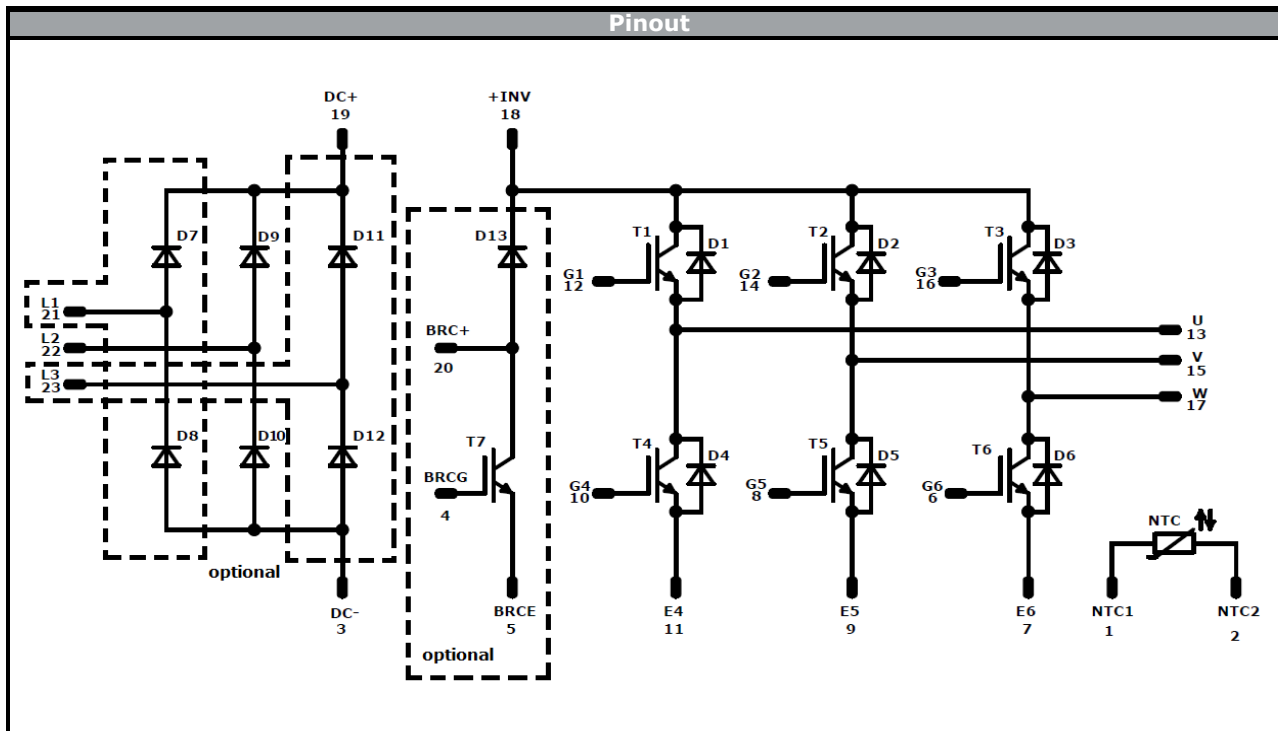

Identification					
ID	Component	Voltage	Current	Function	Comment
D7-D12	Diode	1600 V	25 A	Rectifier Diode	
T1-T6	IGBT	600 V	10 A	Inverter Switch	
D1-D6	FWD	600 V	10 A	Inverter Diode	
T7	IGBT	600 V	6 A	Brake Switch	
D13	FWD	600 V	6 A	Brake Diode	
NTC	NTC			Thermistor	



Packaging instruction			
Standard packaging quantity (SPQ)	135	>SPQ Standard	<SPQ Sample

Handling instruction
Handling instructions for <i>flow</i> 0 packages see vincotech.com website.

Package data
Package data for <i>flow</i> 0 packages see vincotech.com website.

UL recognition and file number
This device is certified according to UL 1557 standard, UL file number E192116. For more information see vincotech.com website. 

Document No.:	Date:	Modification:	Pages
V23990-P543-A28-PM-D8-14	25 Nov. 2018	$R_{thr}$ , $I_{max}$ , $P_{tot}$ Clearance values updated	All

**DISCLAIMER**

The information, specifications, procedures, methods and recommendations herein (together "information") are presented by Vincotech to reader in good faith, are believed to be accurate and reliable, but may well be incomplete and/or not applicable to all conditions or situations that may exist or occur. Vincotech reserves the right to make any changes without further notice to any products to improve reliability, function or design. No representation, guarantee or warranty is made to reader as to the accuracy, reliability or completeness of said information or that the application or use of any of the same will avoid hazards, accidents, losses, damages or injury of any kind to persons or property or that the same will not infringe third parties rights or give desired results. It is reader's sole responsibility to test and determine the suitability of the information and the product for reader's intended use.

**LIFE SUPPORT POLICY**

Vincotech products are not authorised for use as critical components in life support devices or systems without the express written approval of Vincotech.

As used herein:

1. Life support devices or systems are devices or systems which, (a) are intended for surgical implant into the body, or (b) support or sustain life, or (c) whose failure to perform when properly used in accordance with instructions for use provided in labelling can be reasonably expected to result in significant injury to the user.
2. A critical component is any component of a life support device or system whose failure to perform can be reasonably expected to cause the failure of the life support device or system, or to affect its safety or effectiveness.

单击下面可查看定价，库存，交付和生命周期等信息

[>>Vincotech\(威科\)](#)