



flow3xNPC 1

1200 V / 50 A

Features

- NPC with compact design
- Fast switching with IGBT H5+L5 and Stealth Diode
- Low inductive layout
- 3 phase design

Target applications

- Power Supply
- Solar Inverters
- UPS

Types

- 10-PY07N3A050SM-M896F04Y

flow 1 12 mm housing

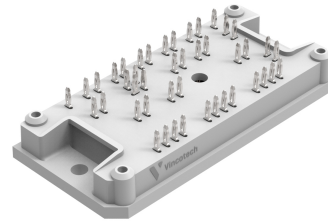

Schematic

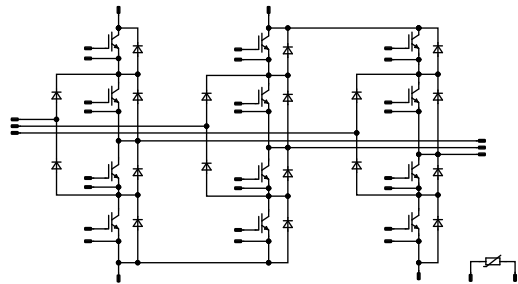



Vincotech

10-PY07N3A050SM-M896F04Y
datasheet

Maximum Ratings

$T_j = 25\text{ °C}$, unless otherwise specified

Parameter	Symbol	Conditions	Value	Unit
-----------	--------	------------	-------	------

Buck Switch

Collector-emitter voltage	V_{CES}		650	V
Collector current	I_C	$T_j = T_{jmax}$ $T_s = 80\text{ °C}$	41	A
Repetitive peak collector current	I_{CRM}	t_p limited by T_{jmax}	150	A
Total power dissipation	P_{tot}	$T_j = T_{jmax}$ $T_s = 80\text{ °C}$	78	W
Gate-emitter voltage	V_{GES}		± 20	V
Maximum junction temperature	T_{jmax}		175	°C

Buck Diode

Peak repetitive reverse voltage	V_{RRM}		650	V
Continuous (direct) forward current	I_F	$T_j = T_{jmax}$ $T_s = 80\text{ °C}$	29	A
Repetitive peak forward current	I_{FRM}	t_p limited by T_{jmax}	180	A
Total power dissipation	P_{tot}	$T_j = T_{jmax}$ $T_s = 80\text{ °C}$	52	W
Maximum junction temperature	T_{jmax}		175	°C

Boost Switch

Collector-emitter voltage	V_{CES}		650	V
Collector current	I_C	$T_j = T_{jmax}$ $T_s = 80\text{ °C}$	84	A
Repetitive peak collector current	I_{CRM}	t_p limited by T_{jmax}	225	A
Total power dissipation	P_{tot}	$T_j = T_{jmax}$ $T_s = 80\text{ °C}$	95	W
Gate-emitter voltage	V_{GES}		± 20	V
Maximum junction temperature	T_{jmax}		175	°C



Vincotech

Maximum Ratings

$T_j = 25\text{ °C}$, unless otherwise specified

Parameter	Symbol	Conditions	Value	Unit
Boost Diode				
Peak repetitive reverse voltage	V_{RRM}		650	V
Continuous (direct) forward current	I_F	$T_j = T_{jmax}$ $T_s = 80\text{ °C}$	23	A
Repetitive peak forward current	I_{FRM}	t_p limited by T_{jmax}	40	A
Total power dissipation	P_{tot}	$T_j = T_{jmax}$ $T_s = 80\text{ °C}$	39	W
Maximum junction temperature	T_{jmax}		175	°C

Boost Sw. Inv. Diode

Peak repetitive reverse voltage	V_{RRM}		650	V
Continuous (direct) forward current	I_F	$T_j = T_{jmax}$ $T_s = 80\text{ °C}$	23	A
Repetitive peak forward current	I_{FRM}	t_p limited by T_{jmax}	40	A
Total power dissipation	P_{tot}	$T_j = T_{jmax}$ $T_s = 80\text{ °C}$	39	W
Maximum junction temperature	T_{jmax}		175	°C

Module Properties

Thermal Properties

Storage temperature	T_{stg}		-40...+125	°C
Operation temperature under switching condition	T_{jop}		-40...+($T_{jmax} - 25$)	°C

Isolation Properties

Isolation voltage	V_{isol}	DC Test Voltage* $t_p = 2\text{ s}$	4000	V
Isolation voltage	V_{isol}	AC Voltage $t_p = 1\text{ min}$	2500	V
Creepage distance			min. 12,7	mm
Clearance			8,6	mm
Comparative Tracking Index	CTI		≥ 200	

*100 % tested in production



Vincotech

Characteristic Values

Parameter	Symbol	Conditions					Values			Unit
		V_{GS} [V]	V_{GE} [V]	V_{DS} [V]	I_D [A]	T_j [°C]	Min	Typ	Max	

Buck Switch

Static

Gate-emitter threshold voltage	$V_{GE(th)}$	$V_{CE} = V_{GE}$			0,0005	25	3,3	4	4,7	V
Collector-emitter saturation voltage	$V_{CE(sat)}$		15		50	25 125		1,83 2,01	2,22	V
Collector-emitter cut-off current	I_{CES}		0	650		25			40	μA
Gate-emitter leakage current	I_{GES}		20	0		25			120	nA
Internal gate resistance	r_g							None		Ω
Input capacitance	C_{ies}	$f = 1 \text{ Mhz}$	0	25		25		3000		pF
Reverse transfer capacitance	C_{res}									
Gate charge	Q_g		15	520	50	25		120		nC

Thermal

Thermal resistance junction to sink*	$R_{th(j-s)}$	$\lambda_{paste} = 3,4 \text{ W/mK}$ (PSX)						1,22		K/W
--------------------------------------	---------------	---	--	--	--	--	--	------	--	-----

*Only valid with pre-applied Vincotech thermal interface material.

Dynamic

Turn-on delay time	$t_{d(on)}$	$R_{gon} = 8 \Omega$ $R_{goff} = 8 \Omega$	-5/15	350	20	25		29		ns
						125		29		
						150		30		
Rise time	t_r					25		6		ns
						125		6		
						150		6		
Turn-off delay time	$t_{d(off)}$					25		98		ns
						125		121		
						150		127		
Fall time	t_f					25		9,7		ns
						125		8,98		
						150		9,6		
Turn-on energy (per pulse)	E_{on}	$Q_{ifwd}=0,508 \mu\text{C}$ $Q_{ifwd}=0,99 \mu\text{C}$ $Q_{ifwd}=1,12 \mu\text{C}$				25		0,142		mWs
						125		0,25		
						150		0,287		
Turn-off energy (per pulse)	E_{off}					25		0,086		mWs
						125		0,142		
						150		0,159		



Vincotech

Characteristic Values

Parameter	Symbol	Conditions					Values			Unit
		V_{GE} [V] V_{GS} [V]	V_{CE} [V] V_{DS} [V] V_F [V]	I_C [A] I_D [A] I_F [A]	T_j [°C]	Min	Typ	Max		

Buck Diode

Static

Forward voltage	V_F				30	25 125		2,47 2,03	2,6	V
Reverse leakage current	I_R	$V_i = 650$ V				25			10	μA

Thermal

Thermal resistance junction to sink*	$R_{th(j-s)}$	$\lambda_{paste} = 3,4$ W/mK (PSX)						1,83		K/W
--------------------------------------	---------------	---------------------------------------	--	--	--	--	--	------	--	-----

*Only valid with pre-applied Vincotech thermal interface material.

Dynamic

Peak recovery current	I_{RRM}					25 125 150		44,04 57,61 61,02		A
Reverse recovery time	t_{rr}					25 125 150		18,91 23,85 25,93		ns
Recovered charge	Q_r	$di/dt=4993$ A/μs $di/dt=4646$ A/μs $di/dt=4409$ A/μs	-5/15	350	20	25 125 150		0,508 0,99 1,12		μC
Reverse recovered energy	E_{rec}					25 125 150		0,104 0,193 0,211		mWs
Peak rate of fall of recovery current	$(di/dt)_{max}$					25 125 150		5933 6559 6494		A/μs



Vincotech

Characteristic Values

Parameter	Symbol	Conditions					Values			Unit
		V_{GE} [V] V_{GS} [V]	V_{CE} [V] V_{DS} [V] V_F [V]	I_C [A] I_D [A] I_F [A]	T_j [°C]	Min	Typ	Max		

Boost Switch

Static

Gate-emitter threshold voltage	$V_{GE(th)}$	$V_{CE} = V_{GE}$			0,001	25	4,2	5	5,8	V
Collector-emitter saturation voltage	$V_{CE(sat)}$		15		75	25 125 150		1,1 1,09 1,09	1,45	V
Collector-emitter cut-off current	I_{CES}		0	650		25			40	μA
Gate-emitter leakage current	I_{GES}		20	0		25			100	nA
Internal gate resistance	r_g							None		Ω
Input capacitance	C_{ies}	$f = 1 \text{ Mhz}$	0	25		25		11625		pF
Reverse transfer capacitance	C_{res}							30		pF
Gate charge	Q_g		15	520	75	25		436		nC

Thermal

Thermal resistance junction to sink*	$R_{th(j-s)}$	$\lambda_{paste} = 3,4 \text{ W/mK}$ (PSX)						1		K/W
--------------------------------------	---------------	---	--	--	--	--	--	---	--	-----

*Only valid with pre-applied Vincotech thermal interface material.

Dynamic

Turn-on delay time	$t_{d(on)}$	$R_{gon} = 4 \Omega$ $R_{goff} = 4 \Omega$	-5/15	350	20	25		68		ns				
						125		66						
						150		66						
Rise time	t_r									25		4		ns
										125		5		
										150		5		
Turn-off delay time	$t_{d(off)}$									25		471		ns
						125		597						
						150		622						
Fall time	t_f					25		81,87		ns				
						125		137,08						
						150		157,21						
Turn-on energy (per pulse)	E_{on}	$Q_{fwd} = 0,901 \mu\text{C}$ $Q_{fwd} = 1,56 \mu\text{C}$ $Q_{fwd} = 1,73 \mu\text{C}$				25		0,052		mWs				
						125		0,096						
						150		0,111						
Turn-off energy (per pulse)	E_{off}					25		1,14		mWs				
						125		1,82						
						150		1,96						



Vincotech

Characteristic Values

Parameter	Symbol	Conditions					Values			Unit
		V_{GE} [V] V_{GS} [V]	V_{CE} [V] V_{DS} [V] V_F [V]	I_C [A] I_D [A] I_F [A]	T_j [°C]	Min	Typ	Max		

Boost Diode

Static

Forward voltage	V_F				20	25 125 150	1,23	1,74 1,66 1,61	1,87	V
Reverse leakage current	I_R	$V_T = 650$ V				25			0,24	μA

Thermal

Thermal resistance junction to sink*	$R_{th(j-s)}$	$\lambda_{paste} = 3,4$ W/mK (PSX)						2,46		K/W
--------------------------------------	---------------	---------------------------------------	--	--	--	--	--	------	--	-----

*Only valid with pre-applied Vincotech thermal interface material.

Dynamic

Peak recovery current	I_{RRM}					25 125 150		41,84 47,61 48,5		A
Reverse recovery time	t_{rr}					25 125 150		17,94 24,4 26,47		ns
Recovered charge	Q_r	$di/dt=4817$ A/μs $di/dt=5026$ A/μs $di/dt=5000$ A/μs	-5/15	350	20	25 125 150		0,901 1,56 1,73		μC
Reverse recovered energy	E_{rec}					25 125 150		0,256 0,455 0,503		mWs
Peak rate of fall of recovery current	$(di_{rr}/dt)_{max}$					25 125 150		6079 4632 4242		A/μs



Vincotech

Characteristic Values

Parameter	Symbol	Conditions						Values			Unit
		V_{GS} [V]	V_{GE} [V]	V_{DS} [V]	V_{CE} [V]	I_D [A]	I_C [A]	T_j [°C]	Min	Typ	

Boost Sw. Inv. Diode

Static

Forward voltage	V_F					20	25 125 150	1,23	1,74 1,66 1,61	1,87	V
Reverse leakage current	I_R	$V_i = 650$ V					25			0,24	μA

Thermal

Thermal resistance junction to sink*	$R_{th(j-s)}$	$\lambda_{paste} = 3,4$ W/mK (PSX)							2,46		K/W
--------------------------------------	---------------	------------------------------------	--	--	--	--	--	--	------	--	-----

*Only valid with pre-applied Vincotech thermal interface material.

Thermistor

Static

Rated resistance	R					25			22		kΩ
Deviation of R_{100}	$\Delta_{R/R}$	$R_{100} = 1484$ Ω				100		-5		5	%
Power dissipation	P								5		mW
Power dissipation constant	d					25			1,5		mW/K
B-value	$B_{(25/50)}$	Tol. ±1 %							3962		K
B-value	$B_{(25/100)}$	Tol. ±1 %							4000		K
Vincotech Thermistor Reference										I	



Buck Switch Characteristics

figure 1. IGBT

Typical output characteristics
 $I_C = f(V_{CE})$

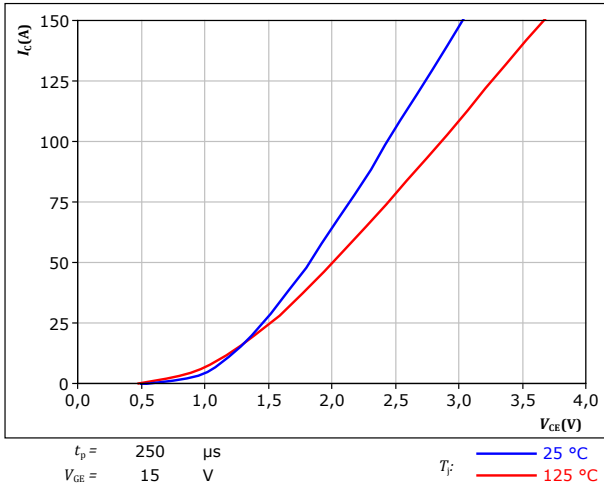

figure 2. IGBT

Typical output characteristics
 $I_C = f(V_{CE})$

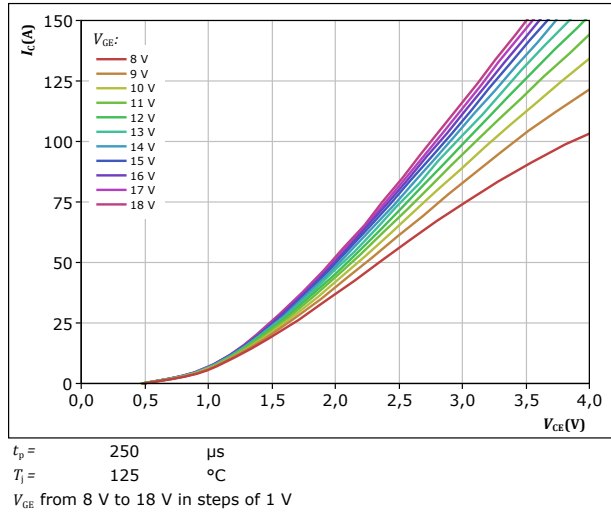

figure 3. IGBT

Typical transfer characteristics
 $I_C = f(V_{GE})$

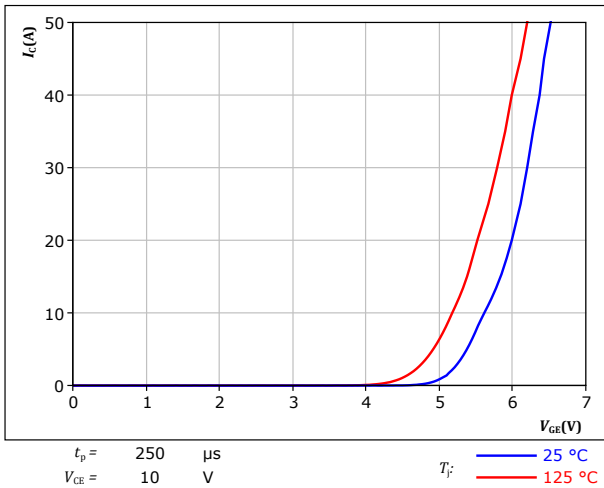
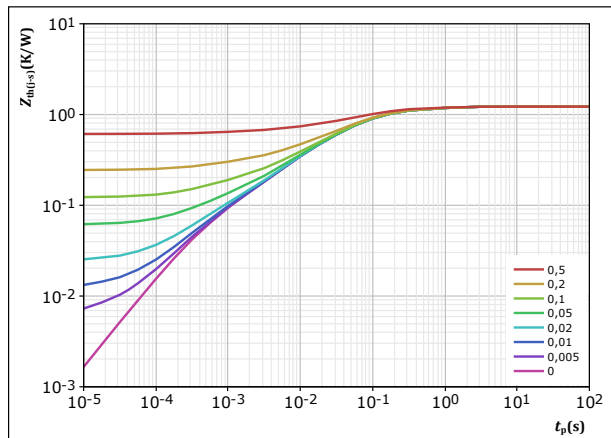

figure 4. IGBT

Transient thermal impedance as a function of pulse width
 $Z_{th(j-s)} = f(t_p)$



$D = t_p / T$
 $R_{th(j-s)} = 1,222 \text{ K/W}$

IGBT thermal model values

R (K/W)	τ (s)
1,28E-01	8,75E-01
4,40E-01	1,12E-01
3,96E-01	3,56E-02
1,75E-01	7,55E-03
3,44E-02	1,97E-03
4,80E-02	4,33E-04



Buck Switch Characteristics

figure 5. IGBT

Safe operating area

$I_C = f(V_{CE})$

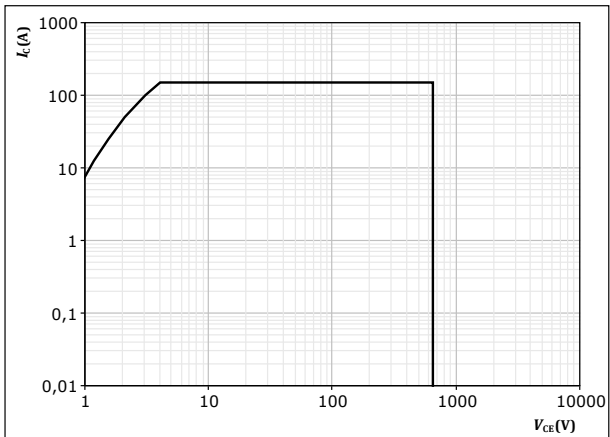

$D = \text{single pulse}$
 $T_s = 80 \text{ } ^\circ\text{C}$
 $V_{CE} = 15 \text{ V}$
 $T_j = T_{jmax}$



Buck Diode Characteristics

figure 6. FWD

Typical forward characteristics

$$I_F = f(V_F)$$

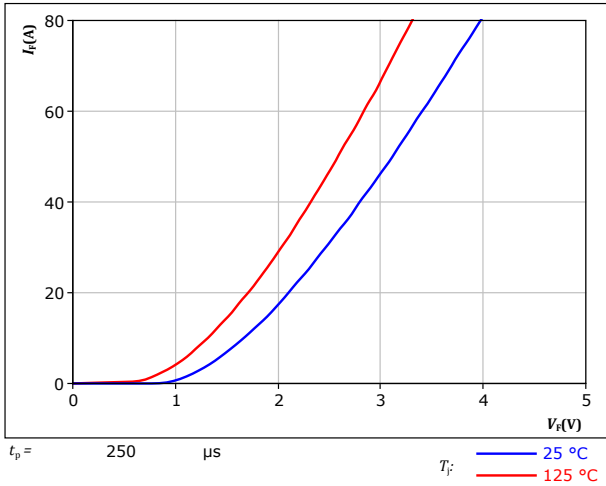
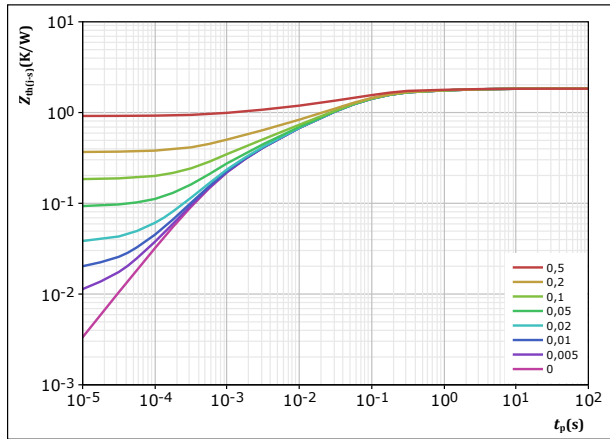

figure 7. FWD

Transient thermal impedance as a function of pulse width

$$Z_{th(j-s)} = f(t_p)$$



$D = t_p / T$

$R_{th(j-s)} = 1,833 \text{ K/W}$

IGBT thermal model values

$R \text{ (K/W)}$	$\tau \text{ (s)}$
6,05E-02	3,63E+00
1,50E-01	6,48E-01
8,27E-01	7,70E-02
4,06E-01	1,51E-02
2,16E-01	3,45E-03
1,73E-01	7,36E-04



Boost Switch Characteristics

figure 8. IGBT

Typical output characteristics

$$I_C = f(V_{CE})$$

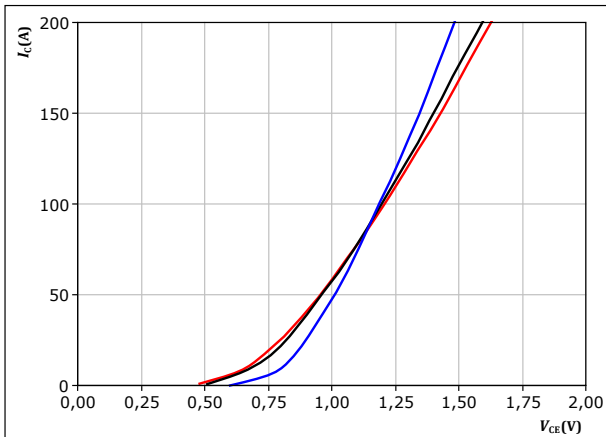

$t_p = 250 \mu s$
 $V_{GE} = 15 V$
 $T_j:$ 25 °C, 125 °C, 150 °C

figure 9. IGBT

Typical output characteristics

$$I_C = f(V_{CE})$$

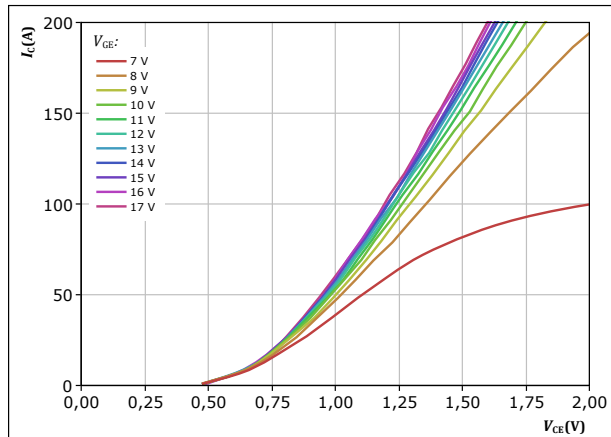

$t_p = 250 \mu s$
 $T_j = 150 \text{ °C}$
 V_{GE} from 7 V to 17 V in steps of 1 V

figure 10. IGBT

Typical transfer characteristics

$$I_C = f(V_{GE})$$

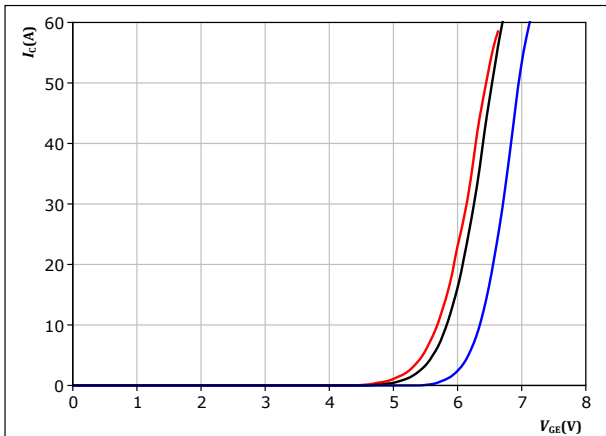

$t_p = 250 \mu s$
 $V_{CE} = 10 V$
 $T_j:$ 25 °C, 125 °C, 150 °C

figure 11. IGBT

Transient thermal impedance as a function of pulse width

$$Z_{th(j-s)} = f(t_p)$$

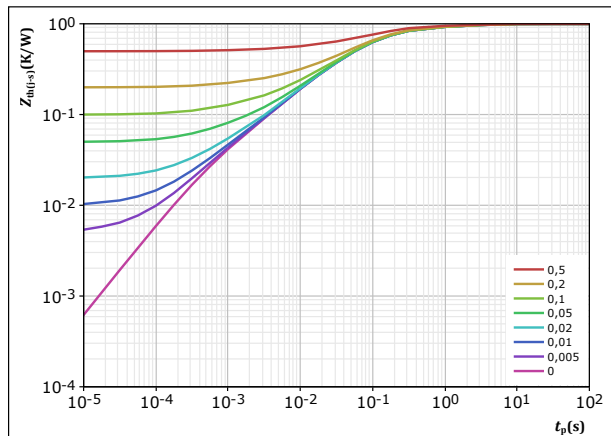

$D = t_p / T$
 $R_{th(j-s)} = 0,996 \text{ K/W}$
IGBT thermal model values

R (K/W)	τ (s)
8,80E-02	2,68E+00
1,67E-01	3,70E-01
5,38E-01	8,09E-02
1,47E-01	1,56E-02
3,80E-02	3,42E-03
1,88E-02	5,45E-04



Vincotech

Boost Switch Characteristics

figure 12. IGBT

Safe operating area

$$I_C = f(V_{CE})$$

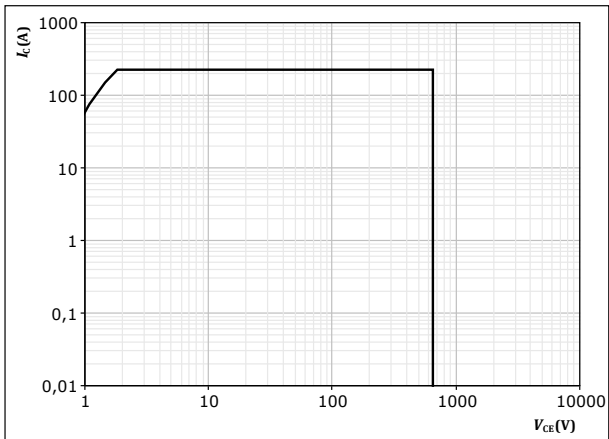

$D =$ single pulse

$T_s = 80$ °C

$V_{CE} = 15$ V

$T_j = T_{jmax}$



Boost Diode Characteristics

figure 13. FWD

Typical forward characteristics

$$I_F = f(V_F)$$

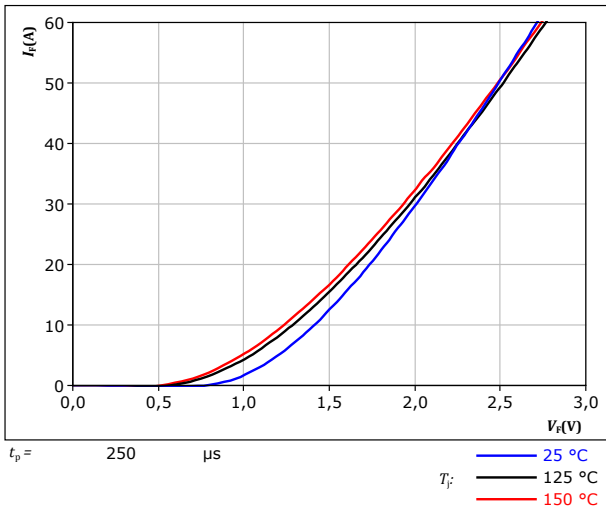
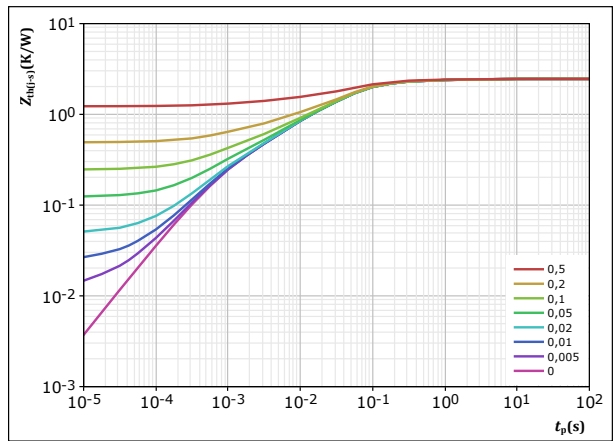

figure 14. FWD

Transient thermal impedance as a function of pulse width

$$Z_{th(j-s)} = f(t_p)$$



$D = \frac{t_p}{T}$
 $R_{th(j-s)} = 2,457 \text{ K/W}$
 IGBT thermal model values

R (K/W)	τ (s)
1,00E-01	2,27E+00
3,37E-01	2,00E-01
1,37E+00	4,58E-02
4,51E-01	6,21E-03
2,01E-01	7,45E-04



Boost Sw. Inv. Diode Characteristics

figure 15. FWD

Typical forward characteristics

$$I_F = f(V_F)$$

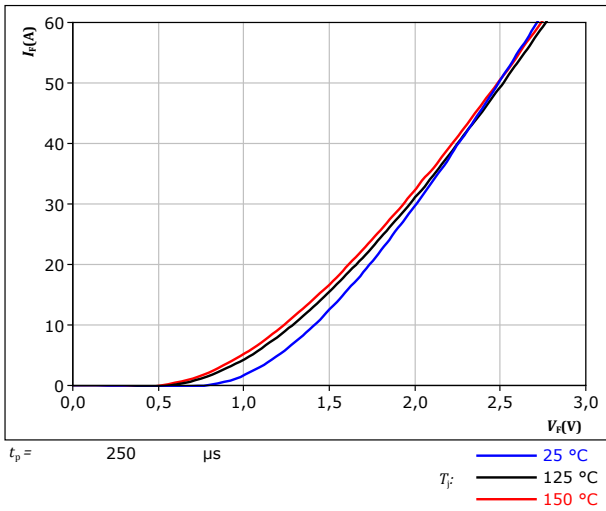
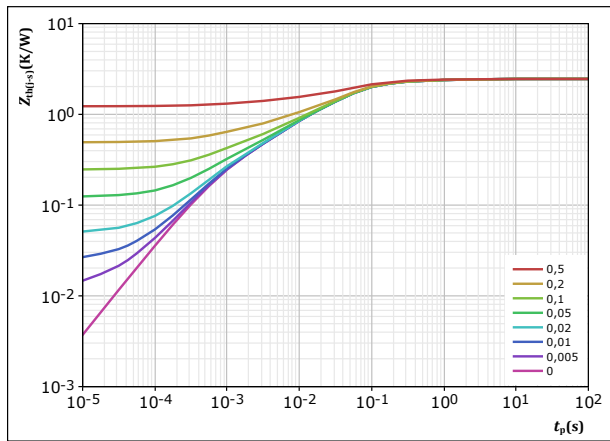

figure 16. FWD

Transient thermal impedance as a function of pulse width

$$Z_{th(j-s)} = f(t_p)$$



$D = \frac{t_p}{T}$
 $R_{th(j-s)} = 2,457 \text{ K/W}$
 IGBT thermal model values

R (K/W)	τ (s)
1,00E-01	2,27E+00
3,37E-01	2,00E-01
1,37E+00	4,58E-02
4,51E-01	6,21E-03
2,01E-01	7,45E-04



Thermistor Characteristics

figure 17. Thermistor

Typical NTC characteristic as function of temperature

$$R_T = f(T)$$

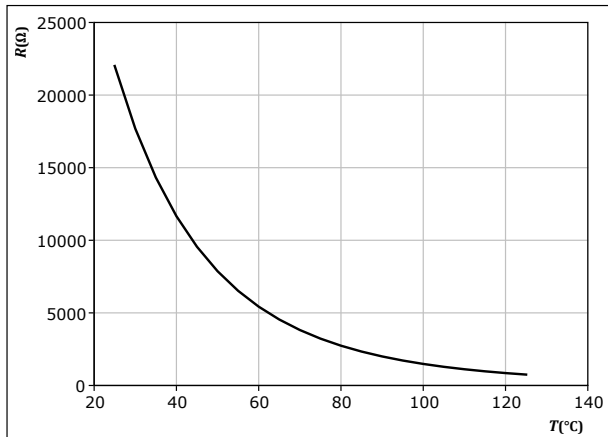



Buck Switching Characteristics

figure 18. IGBT

Typical switching energy losses as a function of collector current
 $E = f(I_c)$

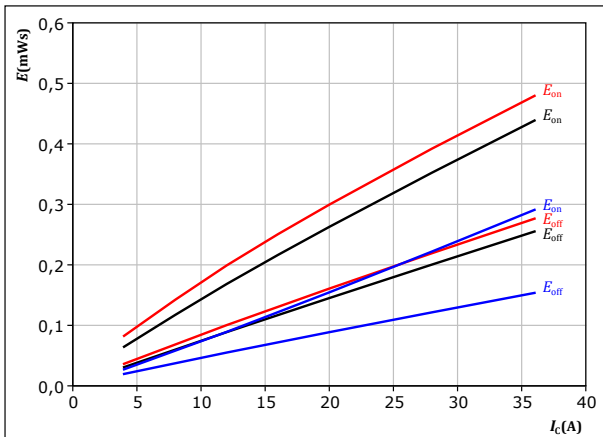

With an inductive load at
 $V_{CE} = 350$ V
 $V_{GE} = -5/15$ V
 $R_{g(on)} = 8$ Ω
 $R_{g(off)} = 8$ Ω
 T_j : 25 °C (blue), 125 °C (black), 150 °C (red)

figure 19. IGBT

Typical switching energy losses as a function of gate resistor
 $E = f(R_g)$

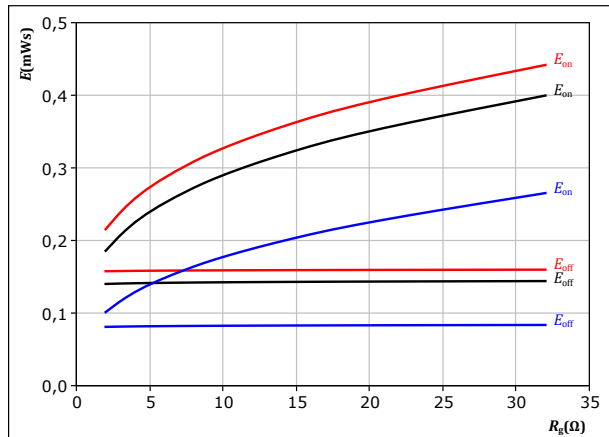

With an inductive load at
 $V_{CE} = 350$ V
 $V_{GE} = -5/15$ V
 $I_c = 20$ A
 T_j : 25 °C (blue), 125 °C (black), 150 °C (red)

figure 20. FWD

Typical reverse recovered energy loss as a function of collector current
 $E_{rec} = f(I_c)$

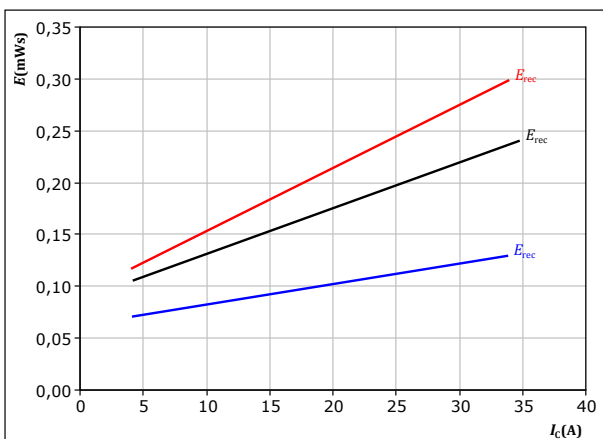

With an inductive load at
 $V_{CE} = 350$ V
 $V_{GE} = -5/15$ V
 $R_{g(on)} = 8$ Ω
 T_j : 25 °C (blue), 125 °C (black), 150 °C (red)

figure 21. FWD

Typical reverse recovered energy loss as a function of gate resistor
 $E_{rec} = f(R_g)$

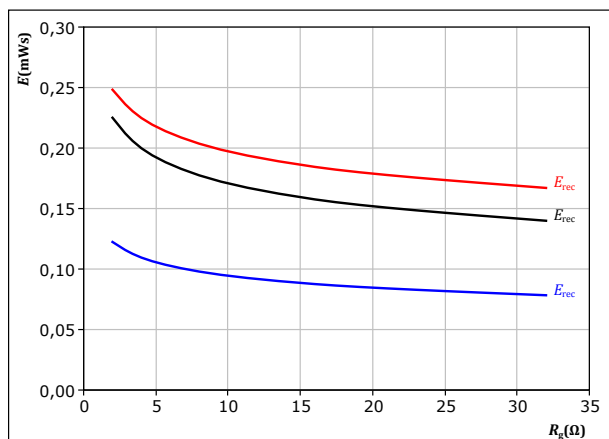

With an inductive load at
 $V_{CE} = 350$ V
 $V_{GE} = -5/15$ V
 $I_c = 20$ A
 T_j : 25 °C (blue), 125 °C (black), 150 °C (red)



Buck Switching Characteristics

figure 22. IGBT

Typical switching times as a function of collector current
 $t = f(I_c)$

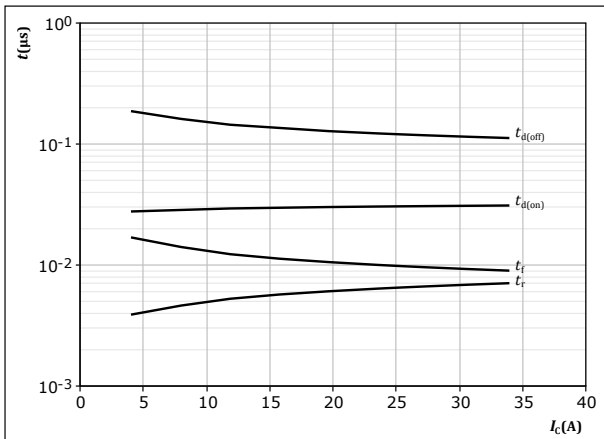

With an inductive load at
 $T_j = 150 \text{ }^\circ\text{C}$
 $V_{CE} = 350 \text{ V}$
 $V_{GE} = -5/15 \text{ V}$
 $R_{gon} = 8 \text{ } \Omega$
 $R_{goff} = 8 \text{ } \Omega$

figure 23. IGBT

Typical switching times as a function of gate resistor
 $t = f(R_g)$

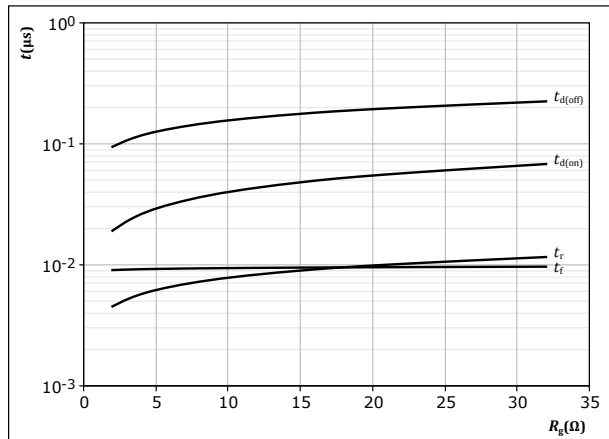

With an inductive load at
 $T_j = 150 \text{ }^\circ\text{C}$
 $V_{CE} = 350 \text{ V}$
 $V_{GE} = -5/15 \text{ V}$
 $I_c = 20 \text{ A}$

figure 24. FWD

Typical reverse recovery time as a function of collector current
 $t_{rr} = f(I_c)$

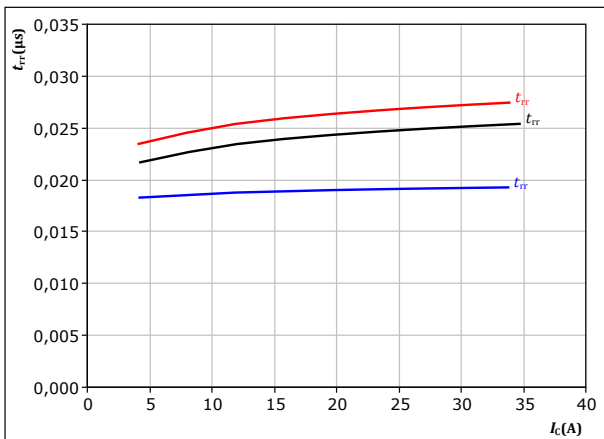

With an inductive load at
 $V_{CE} = 350 \text{ V}$
 $V_{GE} = -5/15 \text{ V}$
 $R_{gon} = 8 \text{ } \Omega$
 $T_j: \text{ } \text{---} 25 \text{ }^\circ\text{C}$
 $\text{---} 125 \text{ }^\circ\text{C}$
 $\text{---} 150 \text{ }^\circ\text{C}$

figure 25. FWD

Typical reverse recovery time as a function of IGBT turn on gate resistor
 $t_{rr} = f(R_{gon})$

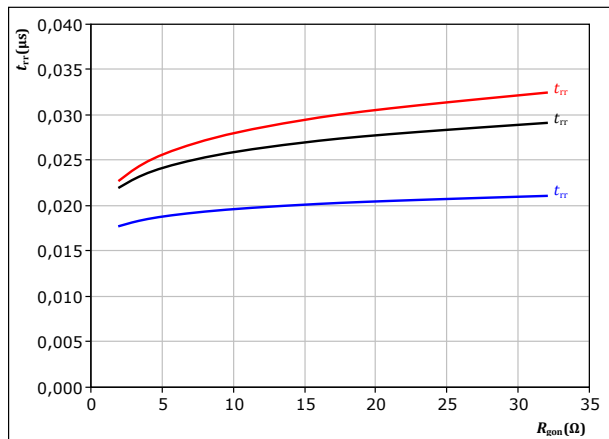

With an inductive load at
 $V_{CE} = 350 \text{ V}$
 $V_{GE} = -5/15 \text{ V}$
 $I_c = 20 \text{ A}$
 $T_j: \text{ } \text{---} 25 \text{ }^\circ\text{C}$
 $\text{---} 125 \text{ }^\circ\text{C}$
 $\text{---} 150 \text{ }^\circ\text{C}$



Buck Switching Characteristics

figure 26. FWD

Typical recovered charge as a function of collector current

$$Q_r = f(I_c)$$

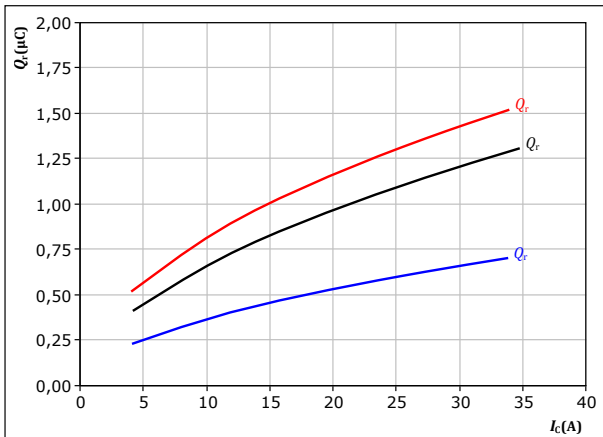

With an inductive load at

$V_{CE} = 350 \text{ V}$
 $V_{GE} = -5/15 \text{ V}$
 $R_{gon} = 8 \ \Omega$

T_j :
— 25 °C
— 125 °C
— 150 °C

figure 27. FWD

Typical recovered charge as a function of turn on gate resistor

$$Q_r = f(R_{gon})$$

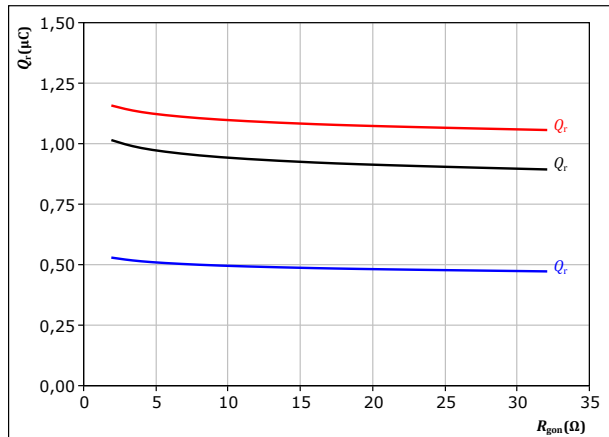

With an inductive load at

$V_{CE} = 350 \text{ V}$
 $V_{GE} = -5/15 \text{ V}$
 $I_c = 20 \text{ A}$

T_j :
— 25 °C
— 125 °C
— 150 °C

figure 28. FWD

Typical peak reverse recovery current as a function of collector current

$$I_{RM} = f(I_c)$$

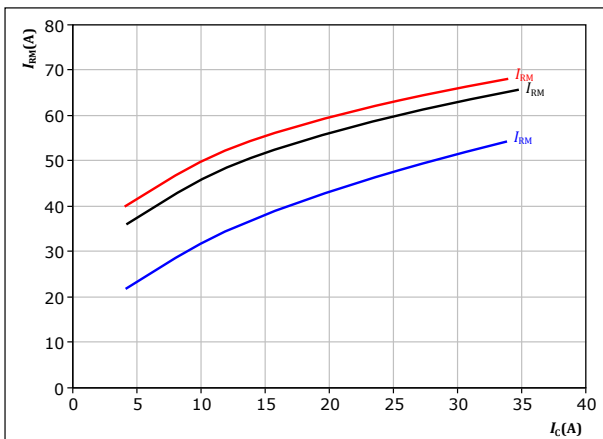

With an inductive load at

$V_{CE} = 350 \text{ V}$
 $V_{GE} = -5/15 \text{ V}$
 $R_{gon} = 8 \ \Omega$

T_j :
— 25 °C
— 125 °C
— 150 °C

figure 29. FWD

Typical peak reverse recovery current as a function of turn on gate resistor

$$I_{RM} = f(R_{gon})$$

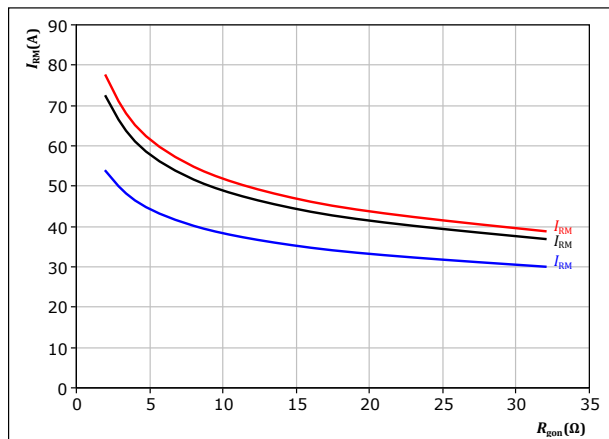

With an inductive load at

$V_{CE} = 350 \text{ V}$
 $V_{GE} = -5/15 \text{ V}$
 $I_c = 20 \text{ A}$

T_j :
— 25 °C
— 125 °C
— 150 °C



Vincotech

Buck Switching Characteristics

figure 30. FWD

Typical rate of fall of forward and reverse recovery current as a function of collector current
 $di_f/dt, di_r/dt = f(I_c)$

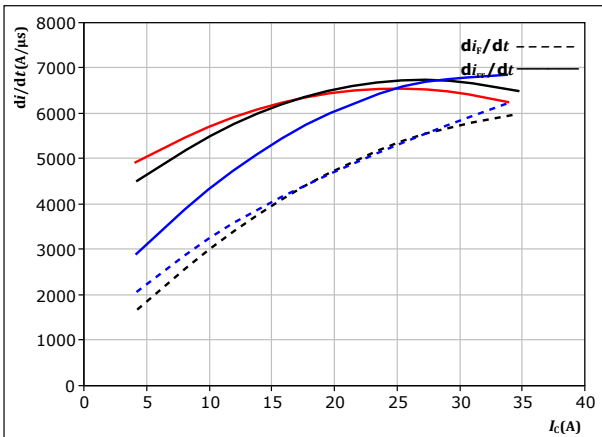

With an inductive load at
 $V_{CE} = 350 \text{ V}$
 $V_{GE} = -5/15 \text{ V}$
 $R_{gon} = 8 \text{ } \Omega$

T_f :
— 25 °C
— 125 °C
— 150 °C

figure 31. FWD

Typical rate of fall of forward and reverse recovery current as a function of turn on gate resistor
 $di_f/dt, di_r/dt = f(R_{gon})$

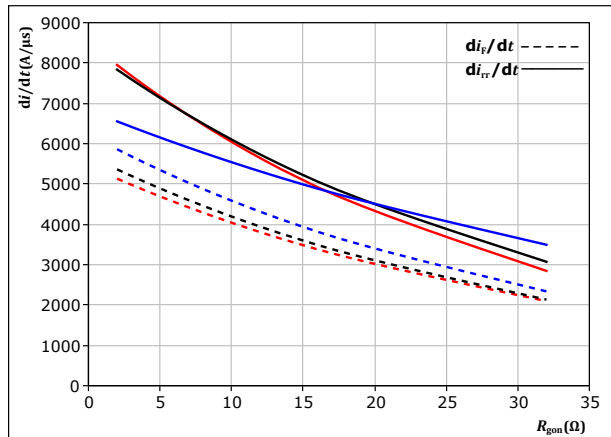

With an inductive load at
 $V_{CE} = 350 \text{ V}$
 $V_{GE} = -5/15 \text{ V}$
 $I_c = 20 \text{ A}$

T_f :
— 25 °C
— 125 °C
— 150 °C

figure 32. IGBT

Reverse bias safe operating area

$I_c = f(V_{CE})$

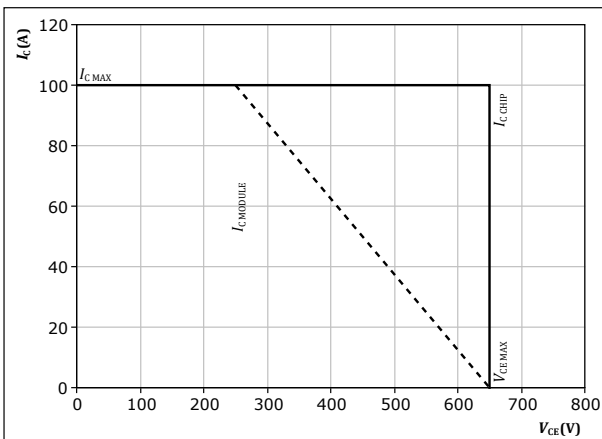

At $T_f = 150 \text{ } ^\circ\text{C}$
 $R_{gon} = 8 \text{ } \Omega$
 $R_{goff} = 8 \text{ } \Omega$



Boost Switching Characteristics

figure 33. IGBT

Typical switching energy losses as a function of collector current
 $E = f(I_c)$

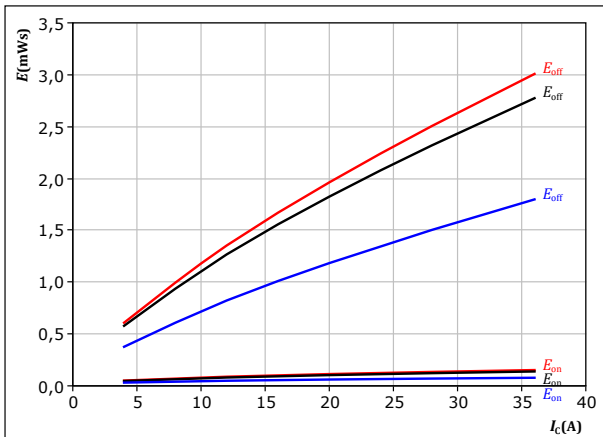

With an inductive load at
 $V_{CE} = 350$ V
 $V_{GE} = -5/15$ V
 $R_{gon} = 4$ Ω
 $R_{goff} = 4$ Ω
 T_j : 25 °C (blue), 125 °C (black), 150 °C (red)

figure 34. IGBT

Typical switching energy losses as a function of gate resistor
 $E = f(R_g)$

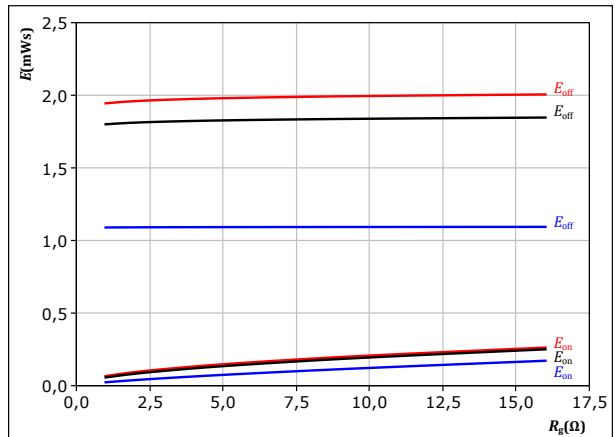

With an inductive load at
 $V_{CE} = 350$ V
 $V_{GE} = -5/15$ V
 $I_c = 20$ A
 T_j : 25 °C (blue), 125 °C (black), 150 °C (red)

figure 35. FWD

Typical reverse recovered energy loss as a function of collector current
 $E_{rec} = f(I_c)$

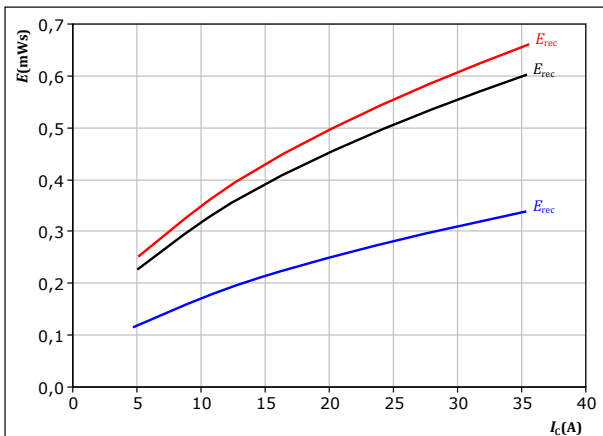

With an inductive load at
 $V_{CE} = 350$ V
 $V_{GE} = -5/15$ V
 $R_{gon} = 4$ Ω
 T_j : 25 °C (blue), 125 °C (black), 150 °C (red)

figure 36. FWD

Typical reverse recovered energy loss as a function of gate resistor
 $E_{rec} = f(R_g)$

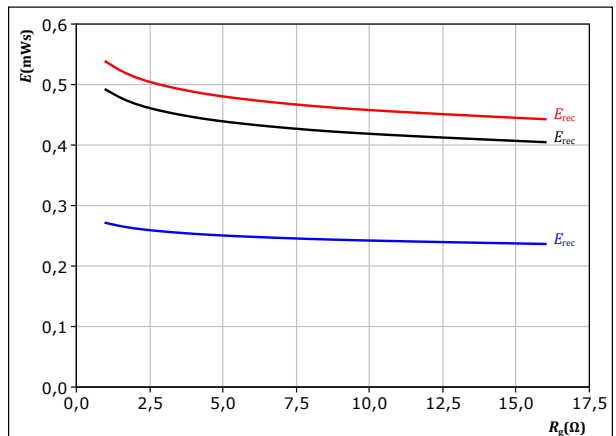

With an inductive load at
 $V_{CE} = 350$ V
 $V_{GE} = -5/15$ V
 $I_c = 20$ A
 T_j : 25 °C (blue), 125 °C (black), 150 °C (red)



Boost Switching Characteristics

figure 37. IGBT

Typical switching times as a function of collector current
 $t = f(I_c)$

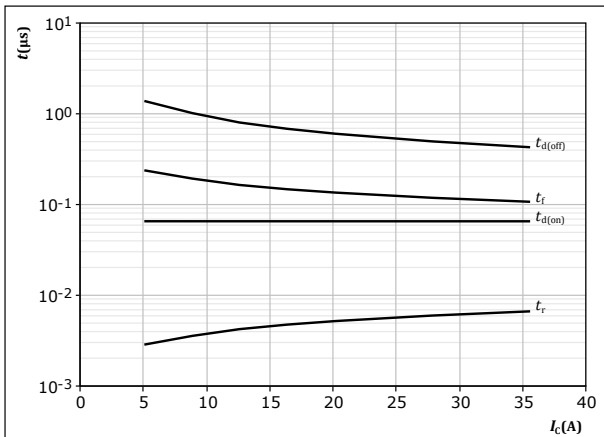

With an inductive load at
 $T_j = 150 \text{ }^\circ\text{C}$
 $V_{CE} = 350 \text{ V}$
 $V_{GE} = -5/15 \text{ V}$
 $R_{gon} = 4 \text{ } \Omega$
 $R_{goff} = 4 \text{ } \Omega$

figure 38. IGBT

Typical switching times as a function of gate resistor
 $t = f(R_g)$

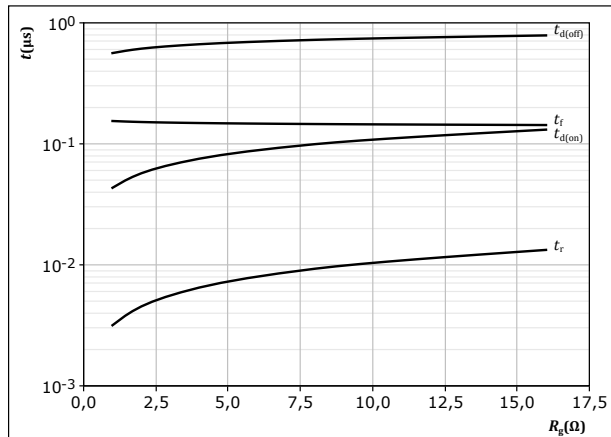

With an inductive load at
 $T_j = 150 \text{ }^\circ\text{C}$
 $V_{CE} = 350 \text{ V}$
 $V_{GE} = -5/15 \text{ V}$
 $I_c = 20 \text{ A}$

figure 39. FWD

Typical reverse recovery time as a function of collector current
 $t_{rr} = f(I_c)$

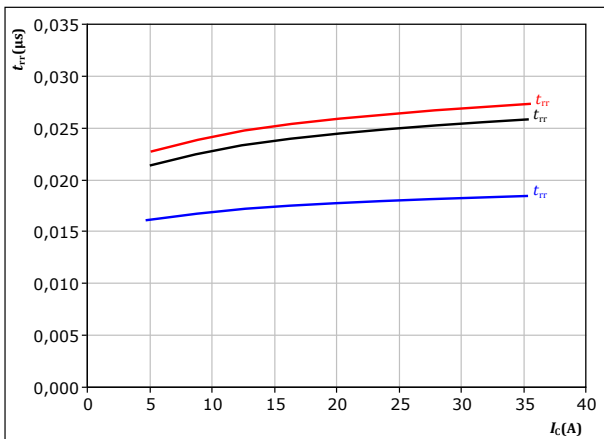

With an inductive load at
 $V_{CE} = 350 \text{ V}$
 $V_{GE} = -5/15 \text{ V}$
 $R_{gon} = 4 \text{ } \Omega$
 $T_j: \text{ } \text{---} 25 \text{ }^\circ\text{C}$
 $\text{---} 125 \text{ }^\circ\text{C}$
 $\text{---} 150 \text{ }^\circ\text{C}$

figure 40. FWD

Typical reverse recovery time as a function of IGBT turn on gate resistor
 $t_{rr} = f(R_{gon})$

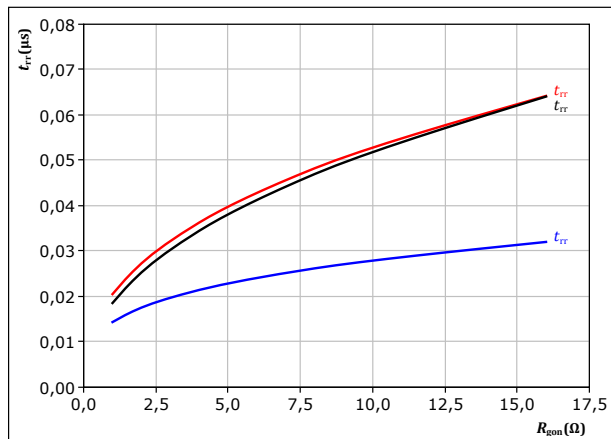

With an inductive load at
 $V_{CE} = 350 \text{ V}$
 $V_{GE} = -5/15 \text{ V}$
 $I_c = 20 \text{ A}$
 $T_j: \text{ } \text{---} 25 \text{ }^\circ\text{C}$
 $\text{---} 125 \text{ }^\circ\text{C}$
 $\text{---} 150 \text{ }^\circ\text{C}$



Boost Switching Characteristics

figure 41. FWD

Typical recovered charge as a function of collector current

$$Q_r = f(I_c)$$

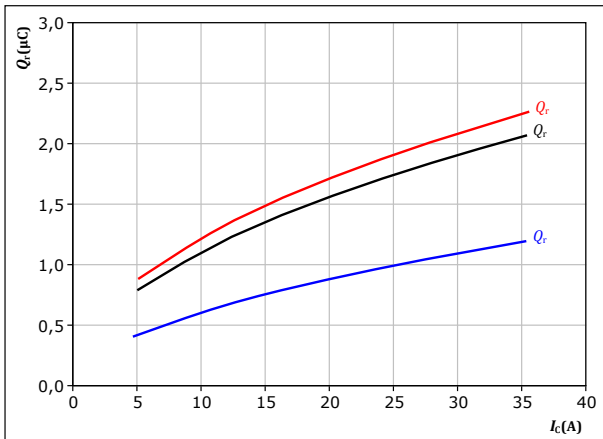

With an inductive load at

$V_{CE} = 350$ V
 $V_{GE} = -5/15$ V
 $R_{gon} = 4$ Ω
 T_j : 25 °C (blue), 125 °C (black), 150 °C (red)

figure 43. FWD

Typical peak reverse recovery current as a function of collector current

$$I_{RM} = f(I_c)$$

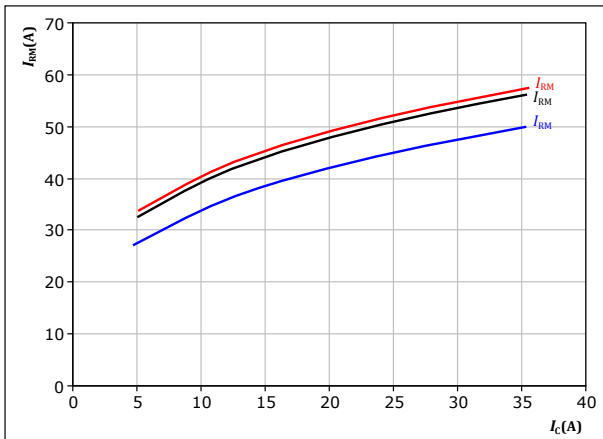

With an inductive load at

$V_{CE} = 350$ V
 $V_{GE} = -5/15$ V
 $R_{gon} = 4$ Ω
 T_j : 25 °C (blue), 125 °C (black), 150 °C (red)

figure 42. FWD

Typical recovered charge as a function of turn on gate resistor

$$Q_r = f(R_{gon})$$

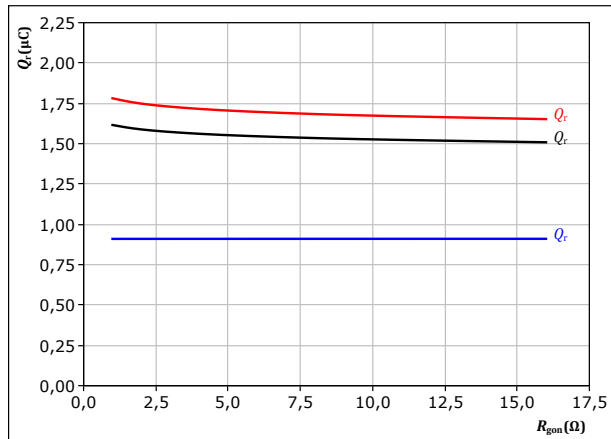

With an inductive load at

$V_{CE} = 350$ V
 $V_{GE} = -5/15$ V
 $I_c = 20$ A
 T_j : 25 °C (blue), 125 °C (black), 150 °C (red)

figure 44. FWD

Typical peak reverse recovery current as a function of turn on gate resistor

$$I_{RM} = f(R_{gon})$$

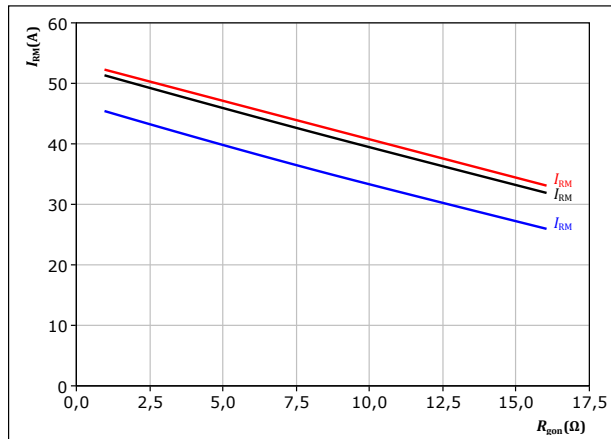

With an inductive load at

$V_{CE} = 350$ V
 $V_{GE} = -5/15$ V
 $I_c = 20$ A
 T_j : 25 °C (blue), 125 °C (black), 150 °C (red)



Boost Switching Characteristics

figure 45. FWD

Typical rate of fall of forward and reverse recovery current as a function of collector current
 $di_i/dt, di_r/dt = f(I_C)$

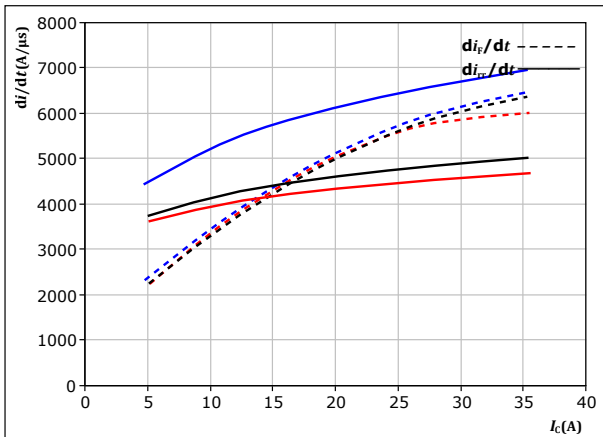

With an inductive load at
 $V_{CE} = 350 \text{ V}$
 $V_{GE} = -5/15 \text{ V}$
 $R_{gon} = 4 \text{ } \Omega$

Legend:
 — 25 °C
 — 125 °C
 — 150 °C

figure 46. FWD

Typical rate of fall of forward and reverse recovery current as a function of turn on gate resistor
 $di_i/dt, di_r/dt = f(R_{gon})$

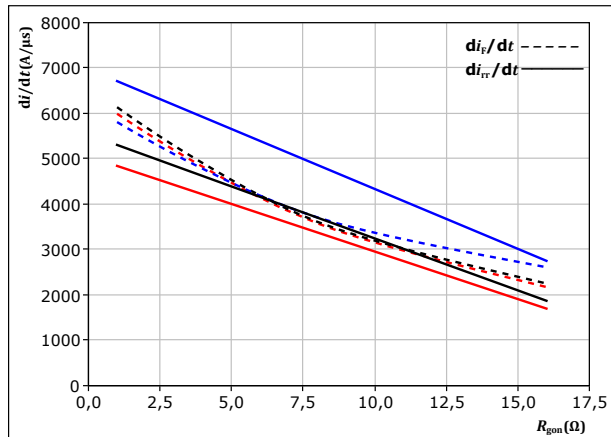

With an inductive load at
 $V_{CE} = 350 \text{ V}$
 $V_{GE} = -5/15 \text{ V}$
 $I_C = 20 \text{ A}$

Legend:
 — 25 °C
 — 125 °C
 — 150 °C

figure 47. IGBT

Reverse bias safe operating area
 $I_C = f(V_{CE})$

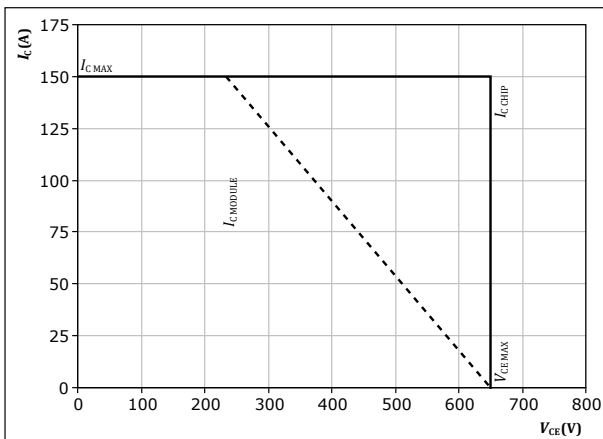

At $T_j = 150 \text{ } ^\circ\text{C}$
 $R_{gon} = 4 \text{ } \Omega$
 $R_{goff} = 4 \text{ } \Omega$



Switching Definitions

figure 48. IGBT

Turn-off Switching Waveforms & definition of t_{doff} , t_{Eoff} (t_{Eoff} = integrating time for E_{off})

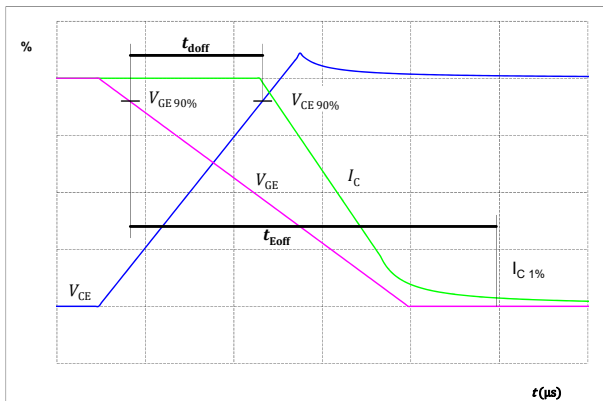

figure 49. IGBT

Turn-on Switching Waveforms & definition of t_{don} , t_{Eon} (t_{Eon} = integrating time for E_{on})

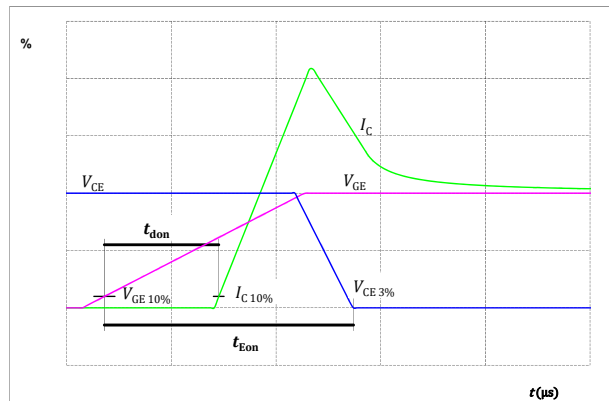

figure 50. IGBT

Turn-off Switching Waveforms & definition of t_f

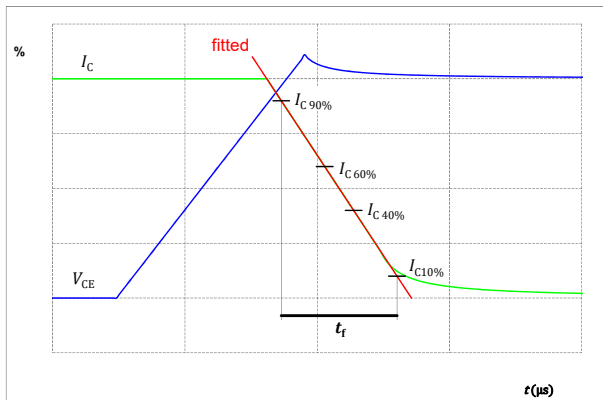
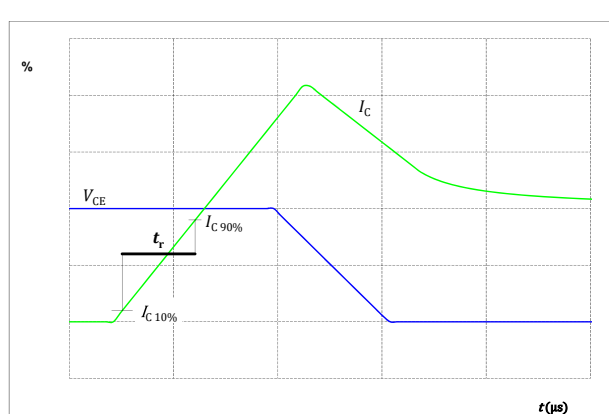

figure 51. IGBT

Turn-on Switching Waveforms & definition of t_r





Switching Definitions

figure 52. FWD

Turn-off Switching Waveforms & definition of t_{rr}

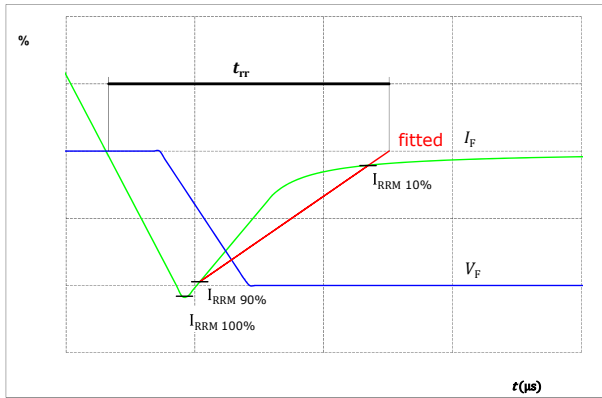
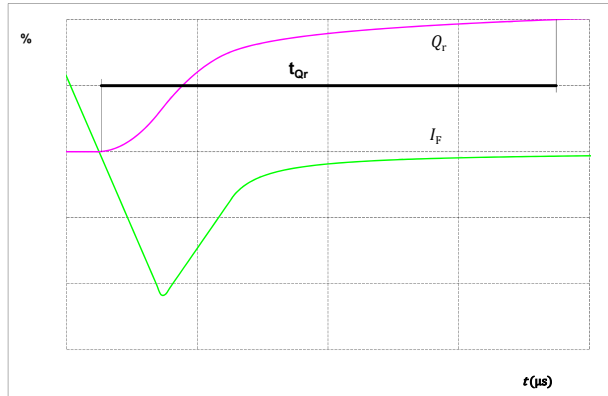

figure 53. FWD

Turn-on Switching Waveforms & definition of t_{Qr} (t_{Qr} = integrating time for Q_r)





10-PY07N3A050SM-M896F04Y

datasheet

Vincotech

Ordering Code	
Version	Ordering Code
Without thermal paste	10-PY07N3A050SM-M896F04Y
With thermal paste	10-PY07N3A050SM-M896F04Y-/3/

Marking						
	Text	Name NN-NNNNNNNNNNNNNN- TTTTTVV	Date code WWYY	UL & VIN UL VIN	Lot LLLLL	Serial SSSS
	Datamatrix	Type&Ver TTTTTTTV	Lot number LLLLL	Serial SSSS	Date code WWYY	

Pin table [mm]			
Pin	X	Y	Function
1	0	28,2	+DC
2	6	28,2	GND
3	9,7	28,2	GND
4	15,7	28,2	-DC
5	18,7	28,2	-DC
6	24,7	28,2	GND
7	27,7	28,2	GND
8	33,8	28,2	+DC
9	36,8	28,2	+DC
10	42,8	28,2	GND
11	46,2	28,2	GND
12	52,2	28,2	-DC
13	52,2	23,7	G10
14	52,2	20,7	S10
15	41,25	20,6	G9
16	38,25	20,6	S9
17	32,55	20,6	S5
18	29,55	20,6	G5
19	18,7	20,7	S6
20	18,7	23,7	G6
21	15,7	23,7	G2
22	15,7	20,7	S2
23	4,75	20,6	G1
24	1,75	20,6	S1
25	8,35	12,2	G4
26	11,35	12,2	S4
27	19,95	12,2	S8
28	22,95	12,2	G8
29	44,35	12,2	G12
30	47,35	12,2	S12
31	52,2	8,9	NTC1
32	52,2	5,9	NTC2
33	46,75	0	OUT3
34	43,95	0	OUT3
35	40,95	0	S11
36	37,95	0	G11
37	29,2	0	G7
38	26,2	0	S7
39	23,2	0	OUT2
40	20,4	0	OUT2
41	11,8	0	OUT1
42	9	0	OUT1
43	6	0	S3
44	3	0	G3

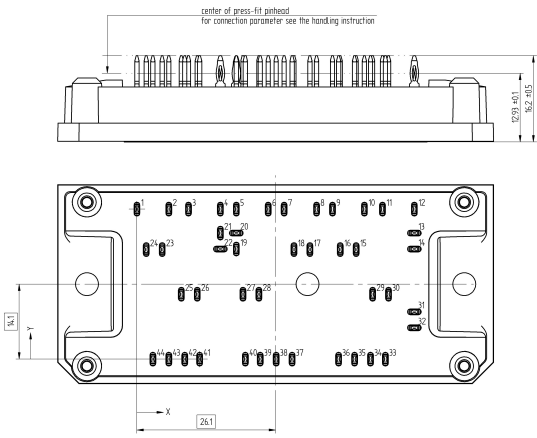

center of press-fit pinhead
for connection parameter see the handling instruction

Tolerance of propositions: ±0.5mm of the end of pins
Dimension of coordinate axis is only offset without tolerance



Vincotech

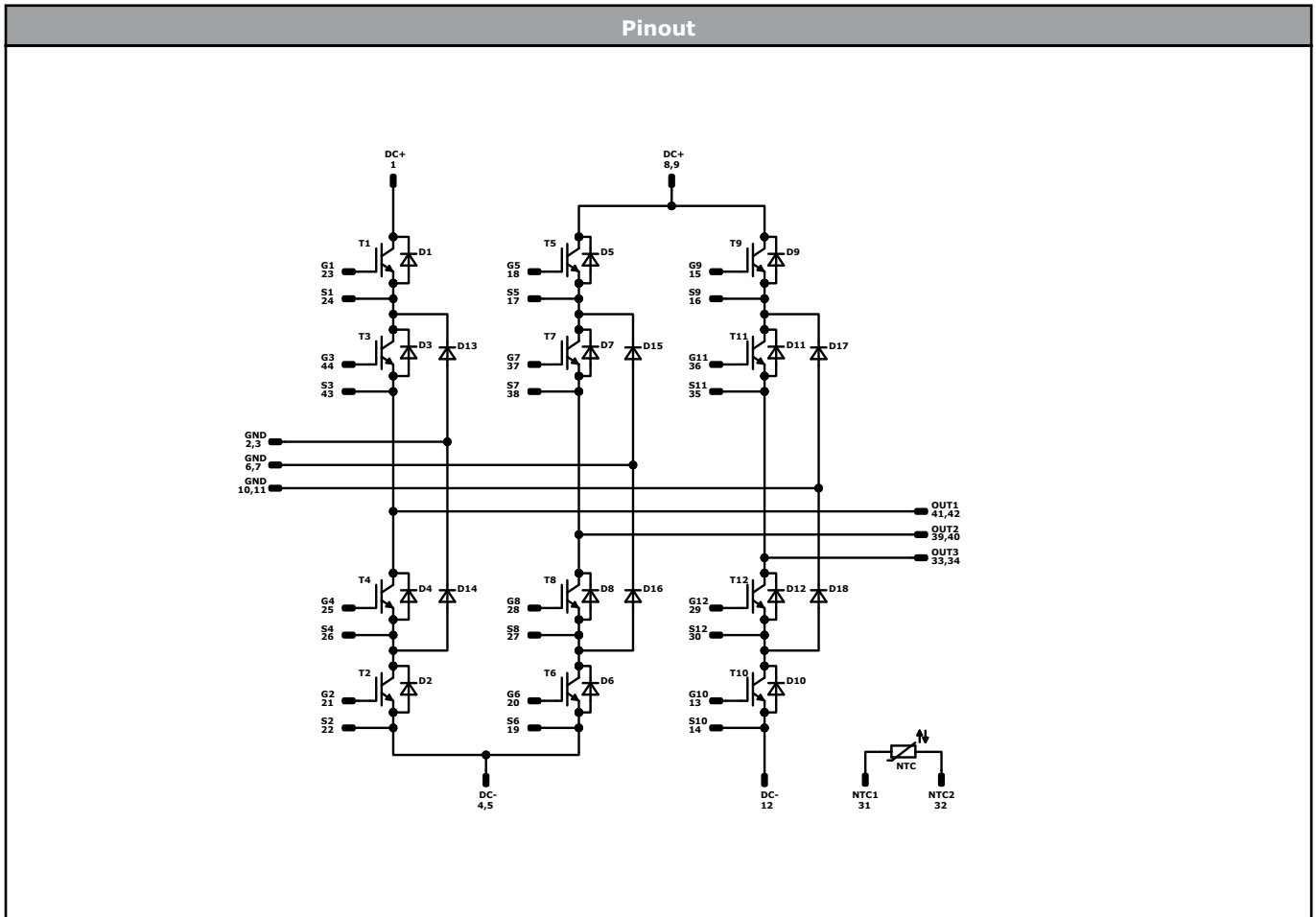

Identification					
ID	Component	Voltage	Current	Function	Comment
T1, T5, T9, T2, T6, T10	IGBT	650 V	50 A	Buck Switch	
D13, D15, D17, D14, D16, D18	FWD	650 V	30 A	Buck Diode	
T3, T7, T11, T4, T8, T12	IGBT	650 V	75 A	Boost Switch	
D2, D6, D10, D1, D5, D9	FWD	650 V	20 A	Boost Diode	
D4, D3, D8, D7, D12, D11	FWD	650 V	20 A	Boost Sw. Inv. Diode	
NTC	NTC			Thermistor	



Vincotech

Packaging instruction				
Standard packaging quantity (SPQ) 100	>SPQ	Standard	<SPQ	Sample

Handling instruction
Handling instructions for <i>flow 1</i> packages see vincotech.com website.

Package data
Package data for <i>flow 1</i> packages see vincotech.com website.

UL recognition and file number
This device is certified according to UL 1557 standard, UL file number E192116. For more information see vincotech.com website. 

Document No.:	Date:	Modification:	Pages
10-PY07N3A050SM-M896F04Y-D1-14	21 May, 2020		

DISCLAIMER

The information, specifications, procedures, methods and recommendations herein (together "information") are presented by Vincotech to reader in good faith, are believed to be accurate and reliable, but may well be incomplete and/or not applicable to all conditions or situations that may exist or occur. Vincotech reserves the right to make any changes without further notice to any products to improve reliability, function or design. No representation, guarantee or warranty is made to reader as to the accuracy, reliability or completeness of said information or that the application or use of any of the same will avoid hazards, accidents, losses, damages or injury of any kind to persons or property or that the same will not infringe third parties rights or give desired results. It is reader's sole responsibility to test and determine the suitability of the information and the product for reader's intended use.

LIFE SUPPORT POLICY

Vincotech products are not authorised for use as critical components in life support devices or systems without the express written approval of Vincotech.

As used herein:

1. Life support devices or systems are devices or systems which, (a) are intended for surgical implant into the body, or (b) support or sustain life, or (c) whose failure to perform when properly used in accordance with instructions for use provided in labelling can be reasonably expected to result in significant injury to the user.
2. A critical component is any component of a life support device or system whose failure to perform can be reasonably expected to cause the failure of the life support device or system, or to affect its safety or effectiveness.

单击下面可查看定价，库存，交付和生命周期等信息

[>>Vincotech\(威科\)](#)