



<i>flowPACK E1</i>	600 V / 50 A
<div style="border: 1px solid black; padding: 5px; margin-bottom: 10px;"> <p style="text-align: center; background-color: #ccc; margin: 0;">Features</p> <ul style="list-style-type: none"> Trenchstop™ IGBT3 technology Standard industrial housing Optimized $R_{th(j-s)}$ with Phase Change Material Built-in NTC </div> <div style="border: 1px solid black; padding: 5px; margin-bottom: 10px;"> <p style="text-align: center; background-color: #ccc; margin: 0;">Target applications</p> <ul style="list-style-type: none"> Industrial Drives </div> <div style="border: 1px solid black; padding: 5px;"> <p style="text-align: center; background-color: #ccc; margin: 0;">Types</p> <ul style="list-style-type: none"> 10-EZ066PA050SA-L855F38T 10-E1066PA050SA-L855F38Z </div>	<div style="border: 1px solid black; padding: 5px; margin-bottom: 10px;"> <p style="text-align: center; background-color: #ccc; margin: 0;"><i>flow E1 12 mm housing</i></p> <div style="display: flex; justify-content: space-around; align-items: center;"> </div> <div style="display: flex; justify-content: space-around; margin-top: 5px;"> Press-fit pin Solder pin </div> </div> <div style="border: 1px solid black; padding: 5px;"> <p style="text-align: center; background-color: #ccc; margin: 0;">Schematic</p> </div>

Maximum Ratings

$T_j = 25\text{ °C}$, unless otherwise specified

Parameter	Symbol	Condition	Value	Unit
Inverter Switch				
Collector-emitter voltage	V_{CES}		600	V
Collector current	I_C	$T_j = T_{jmax}$ $T_s = 80\text{ °C}$	51	A
Repetitive peak collector current	I_{CRM}	t_p limited by T_{jmax}	150	A
Total power dissipation	P_{tot}	$T_j = T_{jmax}$ $T_s = 80\text{ °C}$	95	W
Gate-emitter voltage	V_{GES}		±20	V
Short circuit ratings	t_{SC}	$V_{GE} = 15\text{ V}$ $V_{CE} = 360\text{ V}$ $T_j = 150\text{ °C}$	6	μs
Maximum junction temperature	T_{jmax}		175	°C



Maximum Ratings

$T_j = 25\text{ °C}$, unless otherwise specified

Parameter	Symbol	Condition	Value	Unit
Inverter Diode				
Peak repetitive reverse voltage	V_{RRM}		600	V
Continuous (direct) forward current	I_F	$T_j = T_{jmax}$ $T_s = 80\text{ °C}$	46	A
Repetitive peak forward current	I_{FRM}		100	A
Total power dissipation	P_{tot}	$T_j = T_{jmax}$ $T_s = 80\text{ °C}$	67	W
Maximum junction temperature	T_{jmax}		175	°C

Module Properties

General Properties

Stray inductance	L_P		25	nH
------------------	-------	--	----	----

Thermal Properties

Storage temperature	T_{stg}		-40...+125	°C
Operation temperature under switching condition	T_{jop}		-40...($T_{jmax} - 25$)	°C

Isolation Properties

Isolation voltage	V_{isol}	DC Test Voltage* $t_p = 2\text{ s}$	6000	V
		AC Voltage $t_p = 1\text{ min}$	2500	V
Creepage distance			min. 12,7	mm
Clearance			8,62	mm
Comparative Tracking Index	CTI		≥ 600	

*100 % tested in production



Characteristic Values

Parameter	Symbol	Conditions					Value			Unit
		V_{GS} [V]	V_{GE} [V]	V_{DS} [V]	I_D [A]	T_j [°C]	Min	Typ	Max	

Inverter Switch

Static

Parameter	Symbol	Conditions	V_{GS} [V]	V_{GE} [V]	V_{DS} [V]	I_D [A]	T_j [°C]	Min	Typ	Max	Unit
Gate-emitter threshold voltage	$V_{GE(th)}$	$V_{GE} = V_{CE}$				0,0008	25	5	5,8	6,5	V
Collector-emitter saturation voltage	V_{CEsat}		15			50	25 125 150	1,05	1,57 1,76 1,80	1,85	V
Collector-emitter cut-off current	I_{CES}		0	600			25			2,6	μA
Gate-emitter leakage current	I_{GES}		20	0			25			600	nA
Internal gate resistance	r_g								none		Ω
Input capacitance	C_{ies}								3140		pF
Output capacitance	C_{oes}	$f = 1$ Mhz	0	25		25			200		
Reverse transfer capacitance	C_{res}								93		

Thermal

Parameter	Symbol	Conditions	V_{GS} [V]	V_{GE} [V]	V_{DS} [V]	I_D [A]	T_j [°C]	Min	Typ	Max	Unit
Thermal resistance junction to sink	$R_{th(j-s)}$	$\lambda_{paste} = 3,4$ W/mK (PSX)							1,00		K/W

Dynamic

Parameter	Symbol	Conditions	V_{GS} [V]	V_{GE} [V]	V_{DS} [V]	I_D [A]	T_j [°C]	Min	Typ	Max	Unit
Turn-on delay time	$t_{d(on)}$	$R_{gon} = 8 \Omega$ $R_{goff} = 8 \Omega$	±15	300	50			25	95		ns
Rise time	t_r							150	100		
Turn-off delay time	$t_{d(off)}$							25	14		
Fall time	t_f							150	18		
Turn-on energy (per pulse)*	E_{on}	$Q_{FWD} = 2,3 \mu C$ $Q_{FWD} = 4,4 \mu C$						25	0,675		mWs
Turn-off energy (per pulse)*	E_{off}							150	1,02		
								25	1,30		
								150	1,76		

* $L_s = 14$ nH



Vincotech

10-EZ066PA050SA-L855F38T
10-E1066PA050SA-L855F38Z
 datasheet

Characteristic Values

Parameter	Symbol	Conditions					Value			Unit
		V_{GE} [V]	V_{CE} [V]	I_C [A]	T_j [°C]	Min	Typ	Max		

Inverter Diode

Static

Parameter	Symbol	V_{GE} [V]	V_{CE} [V]	I_C [A]	T_j [°C]	Min	Typ	Max	Unit
Forward voltage	V_F			50	25 125 150		1,64 1,56 1,54	1,9	V
Reverse leakage current	I_R		600		25			27	μA

Thermal

Parameter	Symbol	Conditions	Value	Unit
Thermal resistance junction to sink	$R_{th(j-s)}$	$\lambda_{paste} = 3,4 \text{ W/mK}$ (PSX)	1,41	K/W

Dynamic

Parameter	Symbol	V_{GE} [V]	V_{CE} [V]	I_C [A]	T_j [°C]	Min	Typ	Max	Unit
Peak recovery current	I_{RRM}				25 150		52 62		A
Reverse recovery time	t_{rr}				25 150		130 172		ns
Recovered charge	Q_r			± 15	300	50	2,29 4,37		μC
Reverse recovered energy	E_{rec}				25 150		0,515 0,92		mWs
Peak rate of fall of recovery current	$(di_{rf}/dt)_{max}$				25 150		3909 2375		A/μs

Thermistor

Parameter	Symbol	Conditions	Value	Unit
Rated resistance	R		5	kΩ
Deviation of R_{100}	$\Delta_{R/R}$	$R_{100} = 493 \Omega$	-5	+5
Power dissipation	P		245	mW
Power dissipation constant			1,4	mW/K
B-value	$B_{(25/50)}$	Tol. $\pm 2 \%$	3375	K
B-value	$B_{(25/100)}$	Tol. $\pm 2 \%$	3437	K
Vincotech NTC Reference				K



Inverter Switch Characteristics

figure 1. IGBT

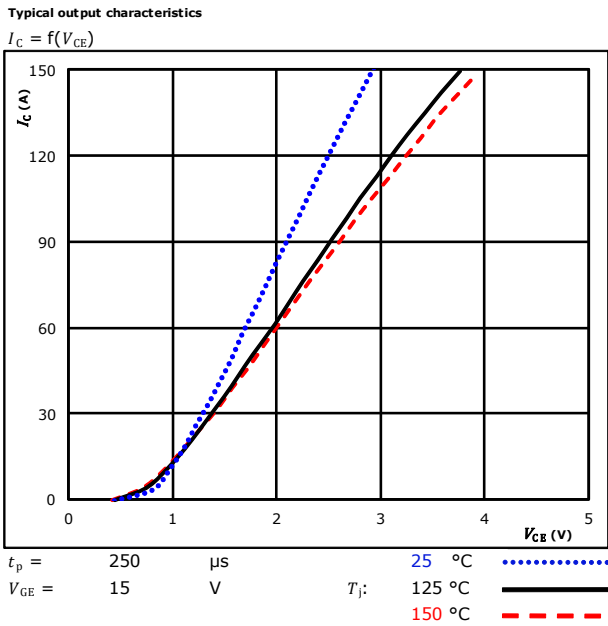

figure 2. IGBT

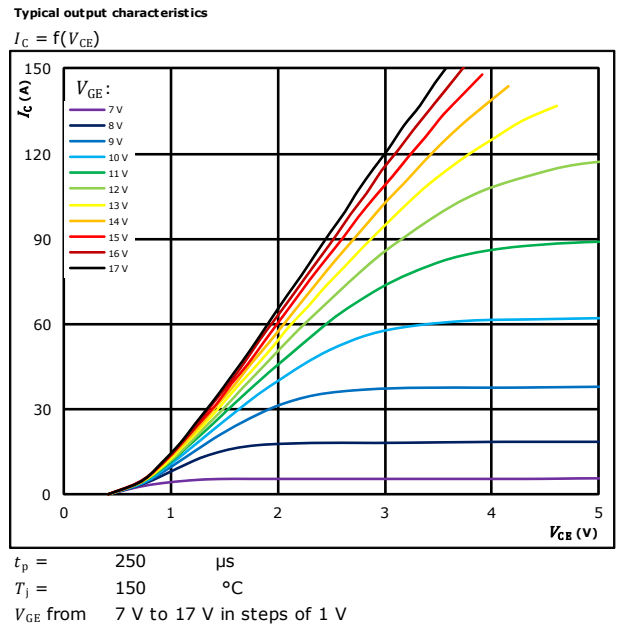

figure 3. IGBT

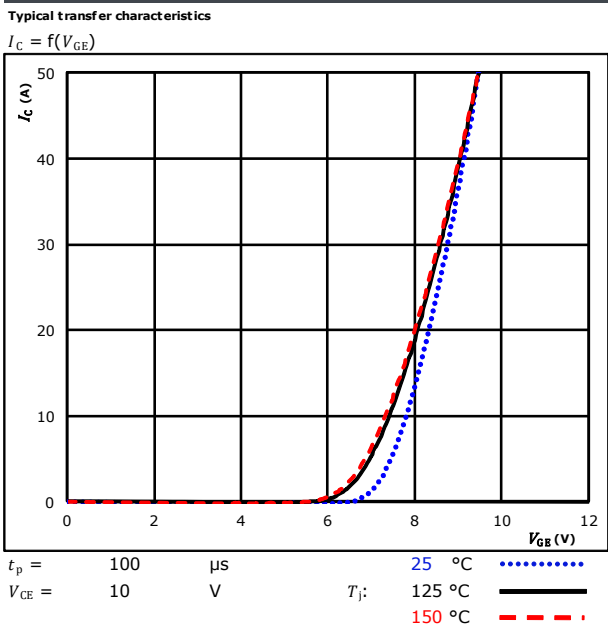
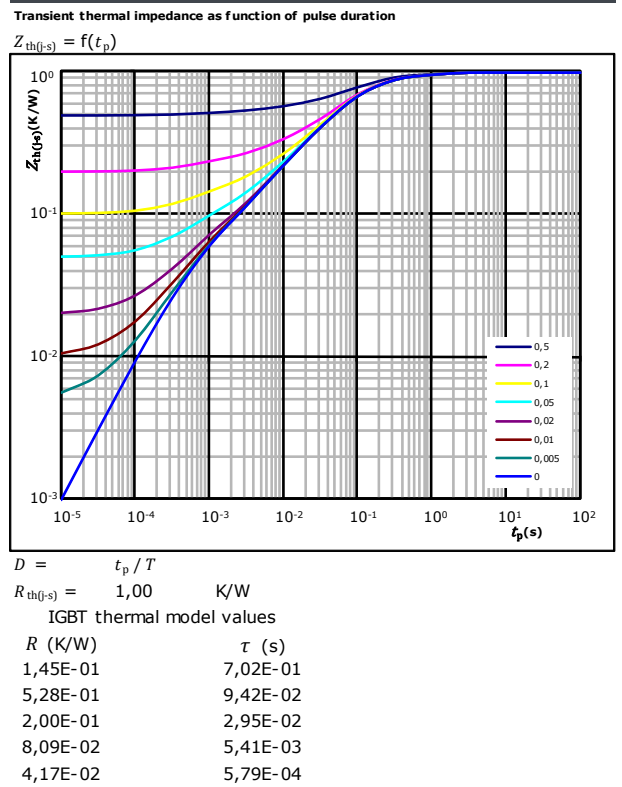

figure 4. IGBT





Inverter Switch Characteristics

figure 5. IGBT

Safe operating area

$$I_C = f(V_{CE})$$

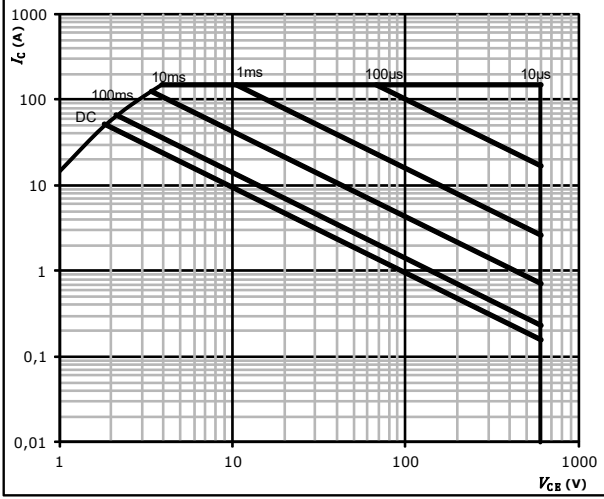

- $D =$ single pulse
- $T_s =$ 80 °C
- $V_{GE} =$ ±15 V
- $T_j =$ T_{max}



Inverter Diode Characteristics

figure 1. **FWD**

Typical forward characteristics

$$I_F = f(V_F)$$

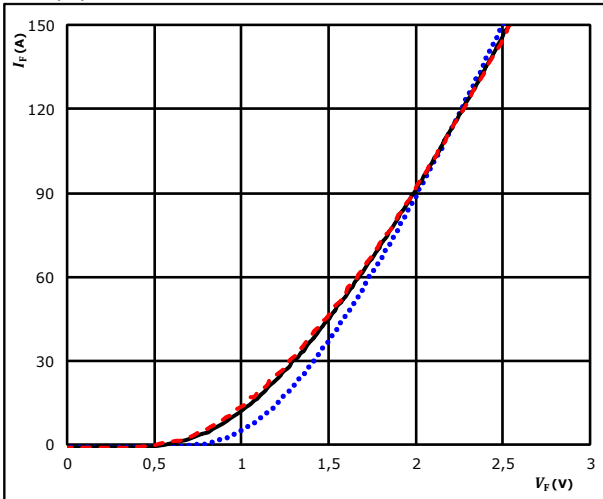

$t_p = 250 \mu s$
 T_j : 25 °C
 125 °C ———
 150 °C - - - -

figure 2. **FWD**

Transient thermal impedance as a function of pulse width

$$Z_{th(j-s)} = f(t_p)$$

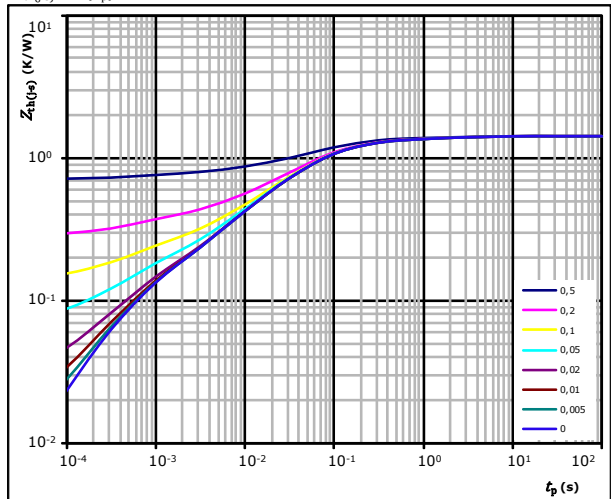

$D = t_p / T$
 $R_{th(j-s)} = 1,41 \text{ K/W}$
 FWD thermal model values

R (K/W)	τ (s)
7,38E-02	2,82E+00
1,47E-01	4,00E-01
6,53E-01	7,18E-02
3,22E-01	2,02E-02
1,24E-01	4,33E-03
9,40E-02	4,82E-04

Thermistor Characteristics

figure 1. **Thermistor**

Typical NTC characteristic as a function of temperature

$$R = f(T)$$

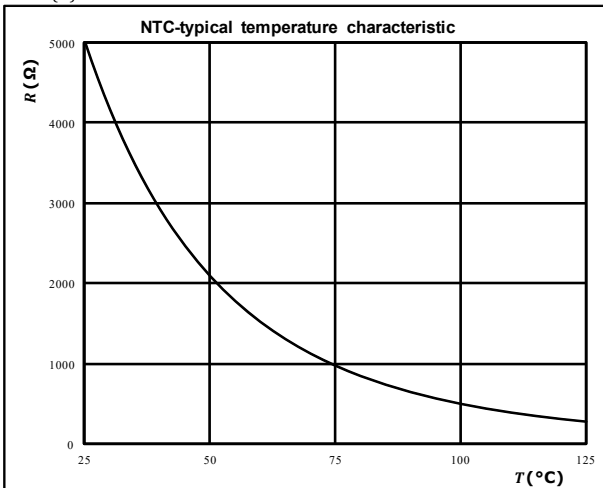



Inverter Switching Characteristics

figure 1. IGBT

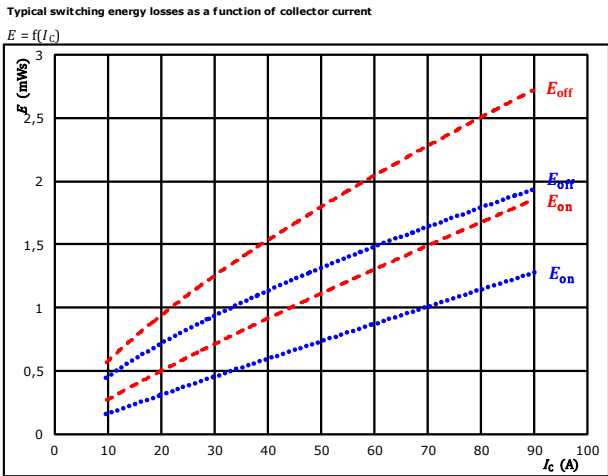

With an inductive load at
 $V_{CE} = 300$ V
 $V_{GE} = \pm 15$ V
 $R_{g(on)} = 8$ Ω
 $R_{g(off)} = 8$ Ω
 $T_j: 25$ °C (blue dotted line)
 150 °C (red dashed line)

figure 2. IGBT

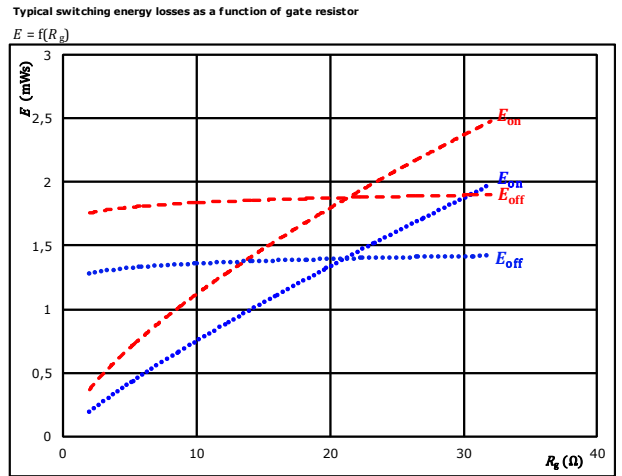

With an inductive load at
 $V_{CE} = 300$ V
 $V_{GE} = \pm 15$ V
 $I_C = 50$ A
 $T_j: 25$ °C (blue dotted line)
 150 °C (red dashed line)

figure 3. FWD

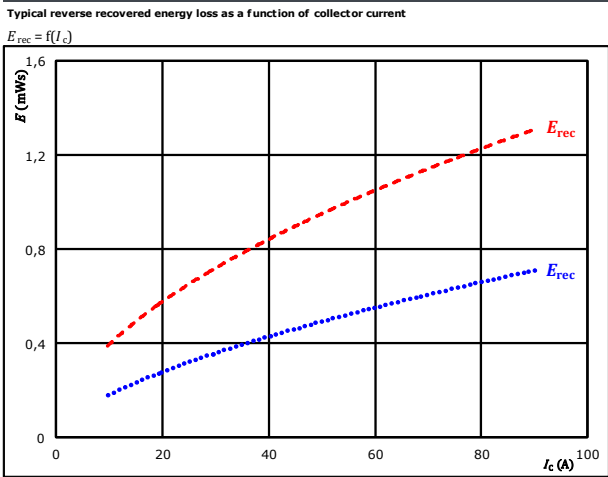

With an inductive load at
 $V_{CE} = 300$ V
 $V_{GE} = \pm 15$ V
 $R_{g(on)} = 8$ Ω
 $T_j: 25$ °C (blue dotted line)
 150 °C (red dashed line)

figure 4. FWD

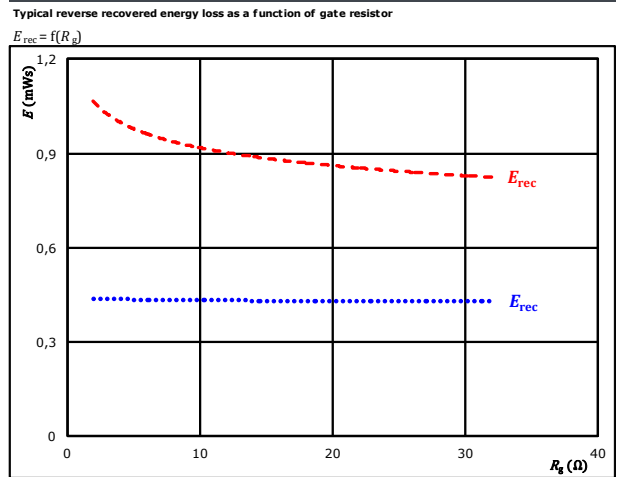

With an inductive load at
 $V_{CE} = 300$ V
 $V_{GE} = \pm 15$ V
 $I_C = 50$ A
 $T_j: 25$ °C (blue dotted line)
 150 °C (red dashed line)



Vincotech

10-EZ066PA050SA-L855F38T
10-E1066PA050SA-L855F38Z
 datasheet

Inverter Switching Characteristics

figure 5. IGBT

Typical switching times as a function of collector current

$$t = f(I_c)$$

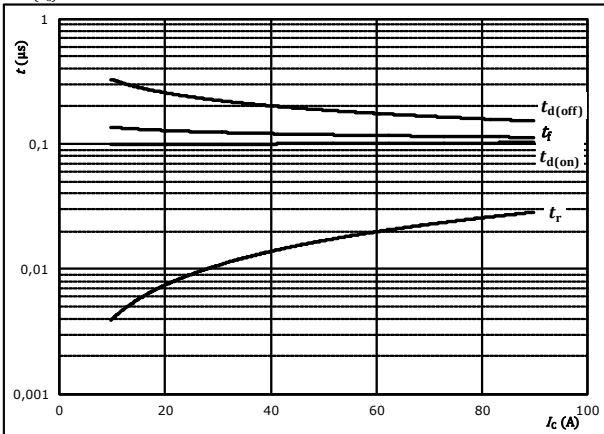

With an inductive load at

$T_j =$	150	°C
$V_{CE} =$	300	V
$V_{GE} =$	±15	V
$R_{g(on)} =$	8	Ω
$R_{g(off)} =$	8	Ω

figure 6. IGBT

Typical switching times as a function of gate resistor

$$t = f(R_g)$$

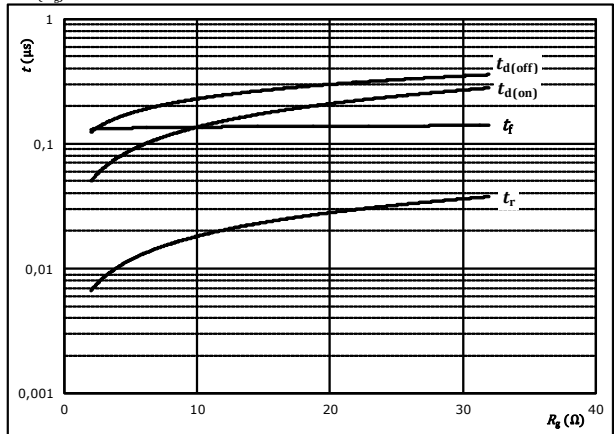

With an inductive load at

$T_j =$	150	°C
$V_{CE} =$	300	V
$V_{GE} =$	±15	V
$I_c =$	50	A

figure 7. FWD

Typical reverse recovery time as a function of collector current

$$t_{rr} = f(I_c)$$

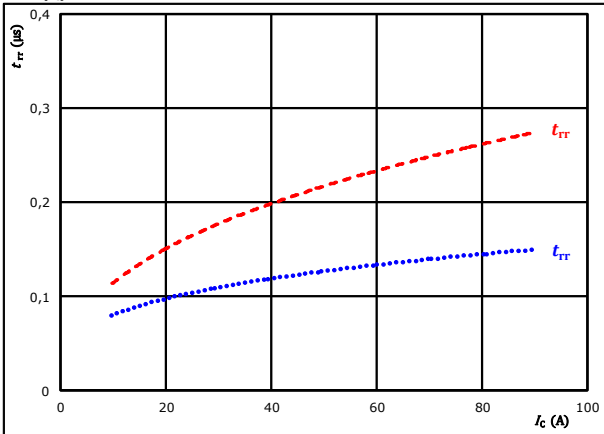

At	$V_{CE} =$	300	V	$T_j =$	25 °C
	$V_{GE} =$	±15	V		150 °C	-----
	$R_{g(on)} =$	8	Ω			

figure 8. FWD

Typical reverse recovery time as a function of IGBT turn on gate resistor

$$t_{rr} = f(R_{g(on)})$$

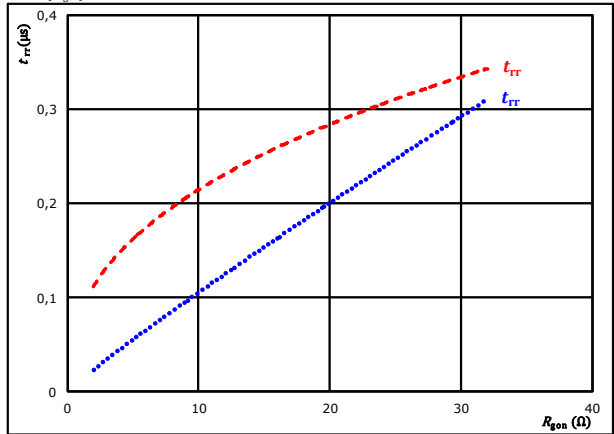

At	$V_{CE} =$	300	V	$T_j =$	25 °C
	$V_{GE} =$	±15	V		150 °C	-----
	$I_c =$	50	A			



Inverter Switching Characteristics

figure 9. FWD

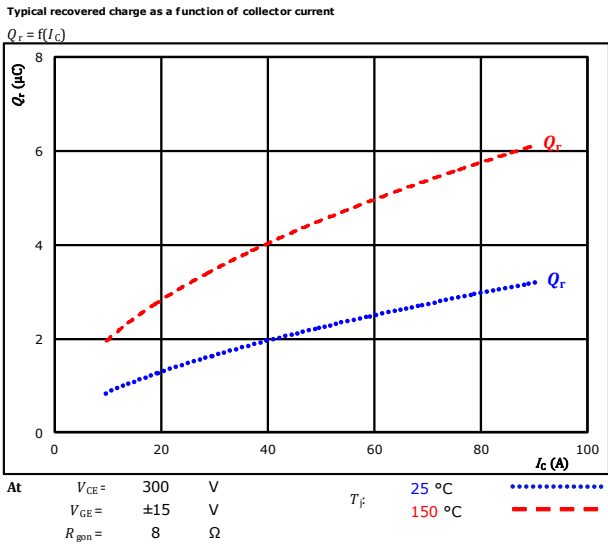

figure 10. FWD

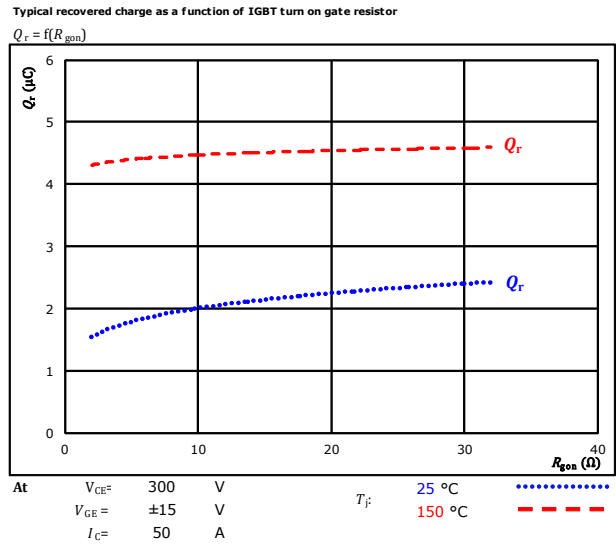

figure 11. FWD

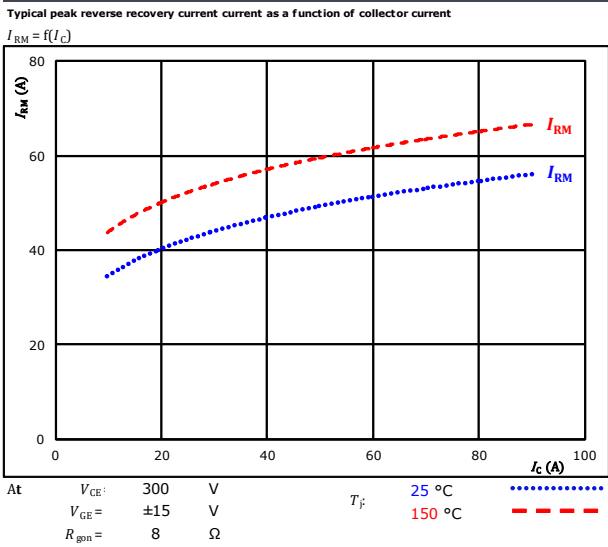
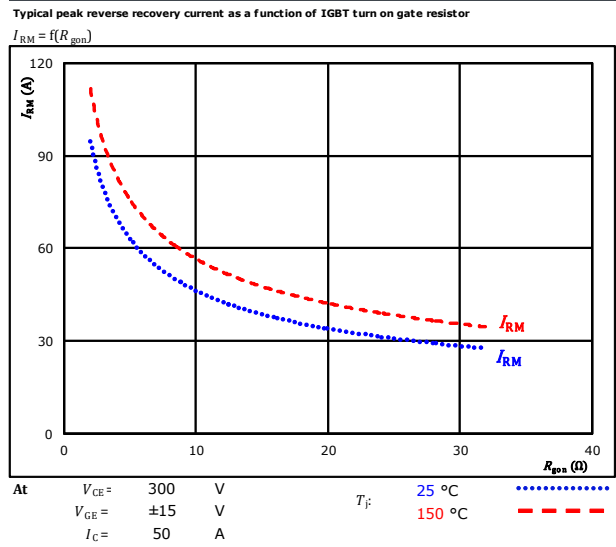

figure 12. FWD





Vincotech

10-EZ066PA050SA-L855F38T
10-E1066PA050SA-L855F38Z
 datasheet

Inverter Switching Characteristics

figure 13. FWD

Typical rate of fall of forward and reverse recovery current as a function of collector current
 $di_f/dt, di_{rr}/dt = f(I_c)$

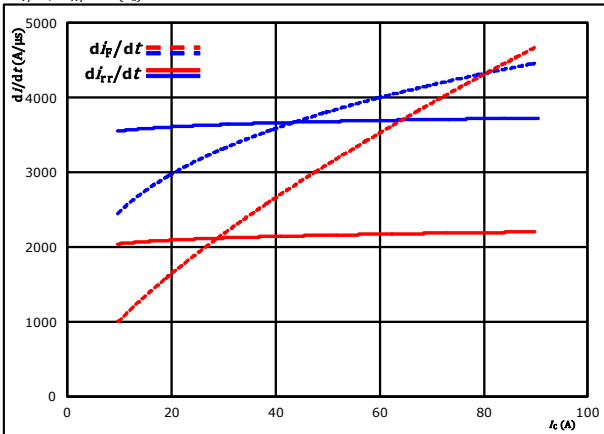

At $V_{CE} = 300$ V
 $V_{GE} = \pm 15$ V
 $R_{g\text{on}} = 8$ Ω
 $T_j = 25$ °C
 150 °C

figure 14. FWD

Typical rate of fall of forward and reverse recovery current as a function of IGBT turn on gate resistor
 $di_f/dt, di_{rr}/dt = f(R_{g\text{on}})$

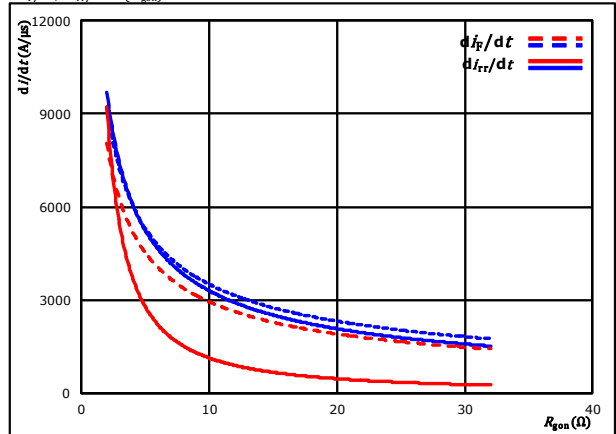

At $V_{CE} = 300$ V
 $V_{GE} = \pm 15$ V
 $I_c = 50$ A
 $T_j = 25$ °C
 150 °C

figure 15. IGBT

Reverse bias safe operating area
 $I_c = f(V_{CE})$

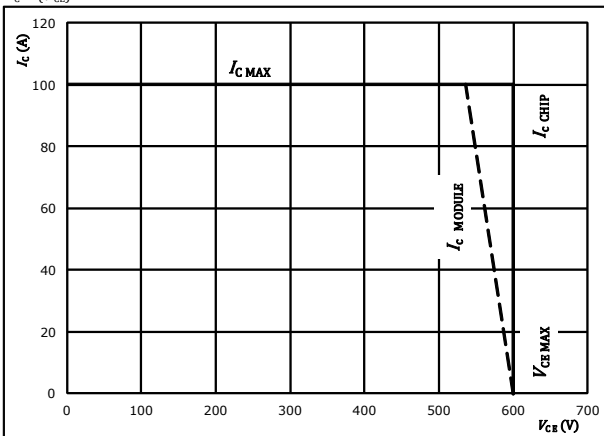

At $T_j = 150$ °C
 $R_{g\text{on}} = 8$ Ω
 $R_{g\text{off}} = 8$ Ω



Vincotech

10-EZ066PA050SA-L855F38T
10-E1066PA050SA-L855F38Z
 datasheet

Inverter Switching Definitions

General conditions

T_j	=	125 °C
R_{gon}	=	8 Ω
R_{goff}	=	8 Ω

figure 1. IGBT

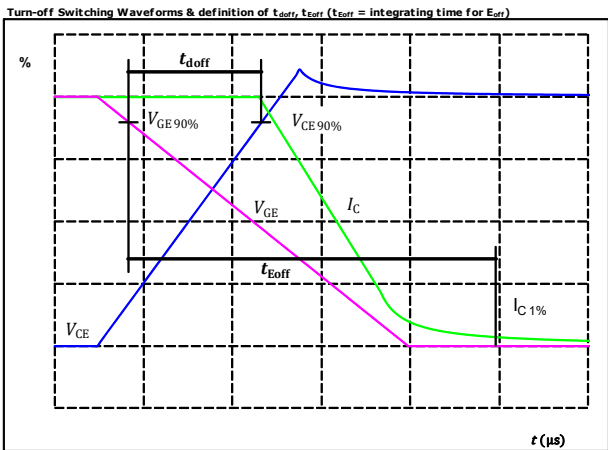

$V_{CE}(0\%) =$	-15	V
$V_{GE}(100\%) =$	15	V
$V_C(100\%) =$	300	V
$I_C(100\%) =$	50	A
$t_{doff} =$	184	ns

figure 2. IGBT

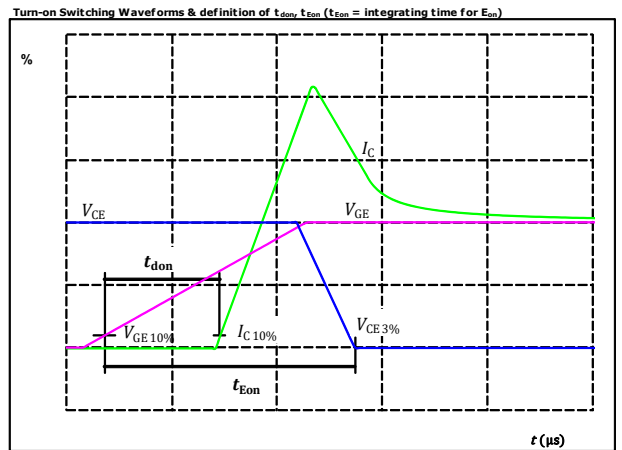

$V_{CE}(0\%) =$	-15	V
$V_{GE}(100\%) =$	15	V
$V_C(100\%) =$	300	V
$I_C(100\%) =$	50	A
$t_{don} =$	100	ns

figure 3. IGBT

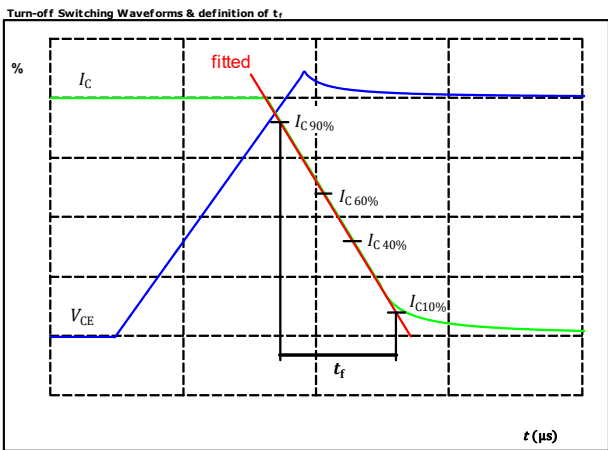

$V_C(100\%) =$	300	V
$I_C(100\%) =$	50	A
$t_f =$	131	ns

figure 4. IGBT

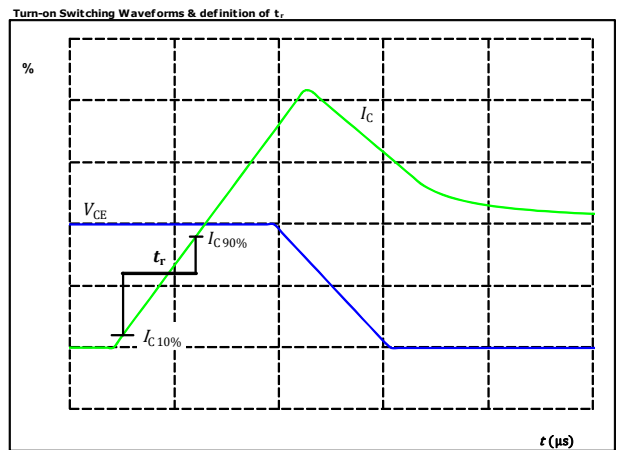

$V_C(100\%) =$	300	V
$I_C(100\%) =$	50	A
$t_r =$	18	ns



Vincotech

10-EZ066PA050SA-L855F38T
10-E1066PA050SA-L855F38Z
 datasheet

Inverter Switching Characteristics

figure 5. FWD

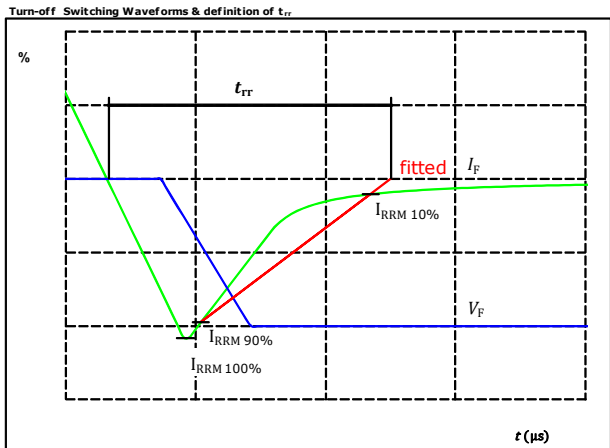

$V_F(100\%) =$	300	V
$I_F(100\%) =$	50	A
$I_{RRM}(100\%) =$	62	A
$t_{rr} =$	172	ns

figure 6. FWD

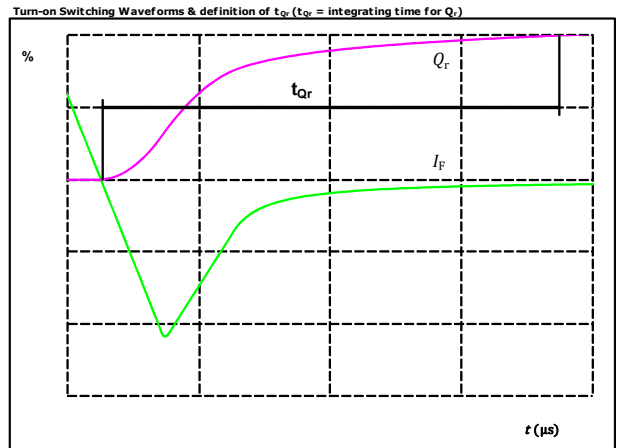

$I_F(100\%) =$	50	A
$Q_r(100\%) =$	4,37	μC



Ordering Code & Marking							
Version			Ordering Code				
without thermal paste 12 mm housing with press-fit pins			10-EZ066PA050SA-L855F38T				
with thermal paste 12 mm housing with press-fit pins			10-EZ066PA050SA-L855F38T-/3/				
without thermal paste 12 mm housing with solder pins			10-E1066PA050SA-L855F38Z				
with thermal paste 12 mm housing with solder pins			10-E1066PA050SA-L855F38Z-/3/				
NN-NNNNNNNNNNNN TTTTIV WWYY UL VIN LLLL SSSS		Text	Name	Date code	UL & VIN	Lot	Serial
			NN-NNNNNNNNNNNN-TTTTIV WWYY UL VIN LLLL SSSS	WWYY	UL VIN	LLLLL	SSSS
Datamatrix		Text	Type&Ver	Lot number	Serial	Date code	
			TTTTIVV	LLLLL	SSSS	WWYY	

Pin table				Outline	
Pin	X	Y	Function		
1	12,8	9,6	DC+		
2	16	9,6	DC+		
3	22,4	9,6	Therm1		
4	25,6	9,6	Therm2		
5	32	9,6	DC-2		
6	32	6,4	S13		
7	32	3,2	DC-1		
8	32	0	S11		
9	28,8	0	G11		
10	6,4	0	Ph1		
11	3,2	0	Ph1		
12	0	0	G12		
13	0	6,4	G14		
14	0	16	Ph2		
15	0	19,2	Ph2		
16	0	25,6	G16		
17	3,2	25,6	Ph3		
18	6,4	25,6	Ph3		
19	28,8	25,6	G15		
20	32	25,6	S15		
21	32	22,4	DC-3		
22	32	16	G13		

Tolerance of pinpositions: ±0.4mm at the end of pins
 Dimension of coordinate axis is only offset without tolerance



Vincotech

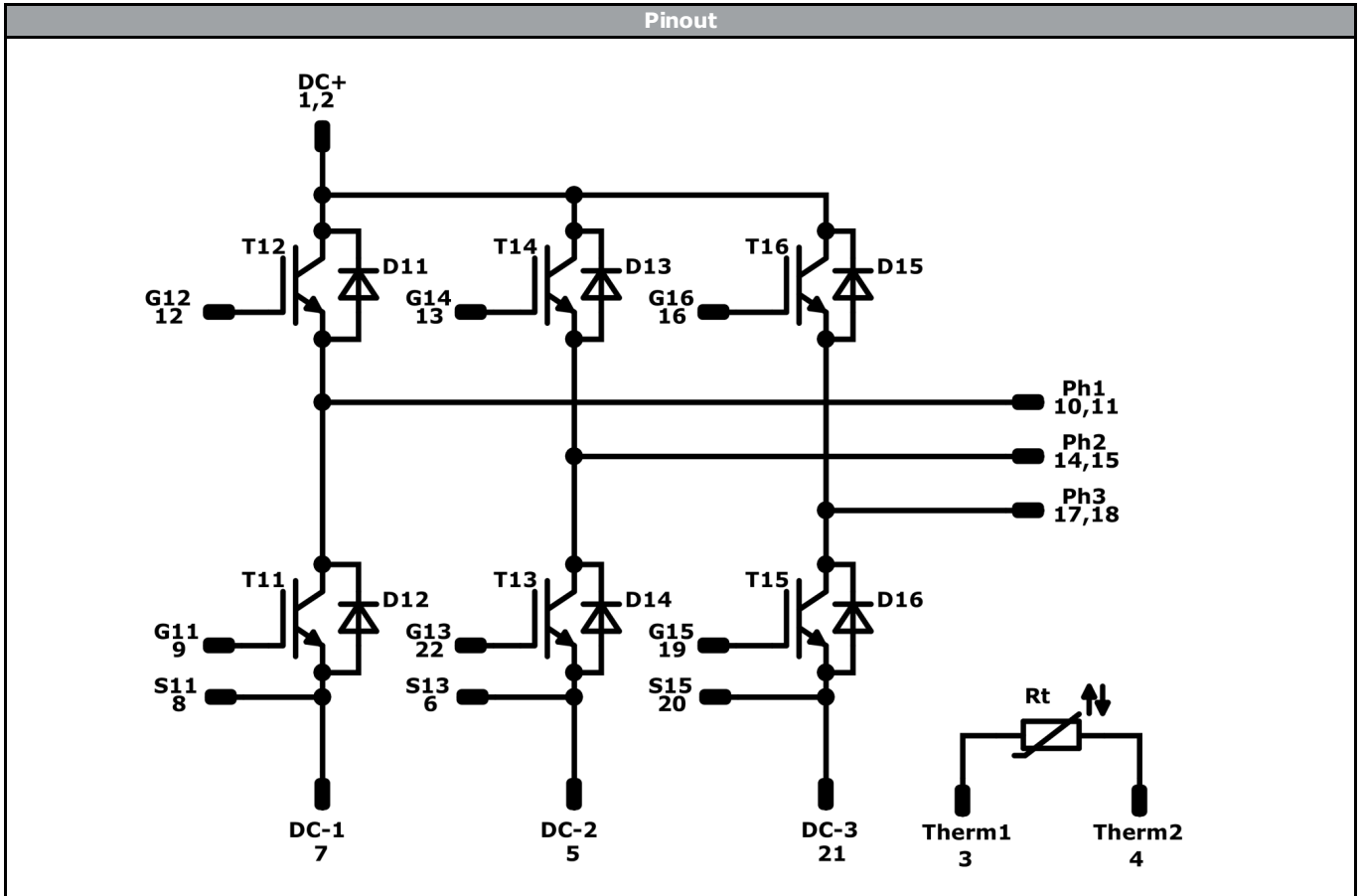

Identification					
ID	Component	Voltage	Current	Function	Comment
T11, T12, T13, T14, T15, T16	IGBT	600 V	50 A	Inverter Switch	
D11, D12, D13, D14, D15, D16	FWD	600 V	50 A	Inverter Diode	
Rt	NTC			Thermistor	



Vincotech

10-EZ066PA050SA-L855F38T
10-E1066PA050SA-L855F38Z
datasheet

Packaging instruction			
Standard packaging quantity (SPQ) 100	>SPQ	Standard	<SPQ Sample

Handling instruction
Handling instructions for <i>flow</i> E1 packages see vincotech.com website.

Package data
Package data for <i>flow</i> E1 packages see vincotech.com website.

UL recognition and file number
This device is certified according to UL 1557 standard, UL file number E192116. For more information see vincotech.com website. 

Document No.:	Date:	Modification:	Pages
10-Ex066PA050SA-L855F38x-D3-14	30 May. 2019	Correction of I_c/I_f values Outline updated	1 14

DISCLAIMER

The information, specifications, procedures, methods and recommendations herein (together "information") are presented by Vincotech to reader in good faith, are believed to be accurate and reliable, but may well be incomplete and/or not applicable to all conditions or situations that may exist or occur. Vincotech reserves the right to make any changes without further notice to any products to improve reliability, function or design. No representation, guarantee or warranty is made to reader as to the accuracy, reliability or completeness of said information or that the application or use of any of the same will avoid hazards, accidents, losses, damages or injury of any kind to persons or property or that the same will not infringe third parties rights or give desired results. It is reader's sole responsibility to test and determine the suitability of the information and the product for reader's intended use.

LIFE SUPPORT POLICY

Vincotech products are not authorised for use as critical components in life support devices or systems without the express written approval of Vincotech.

As used herein:

1. Life support devices or systems are devices or systems which, (a) are intended for surgical implant into the body, or (b) support or sustain life, or (c) whose failure to perform when properly used in accordance with instructions for use provided in labelling can be reasonably expected to result in significant injury to the user.
2. A critical component is any component of a life support device or system whose failure to perform can be reasonably expected to cause the failure of the life support device or system, or to affect its safety or effectiveness.

单击下面可查看定价，库存，交付和生命周期等信息

[>>Vincotech\(威科\)](#)