



**flowNPC 2**

**650 V / 320 A**

**Topology features**

- Kelvin Emitter for improved switching performance
- Neutral Point Clamped Topology (I-Type)
- Temperature sensor

**Component features**

- High speed and smooth switching
- Low gate charge
- Very low collector emitter saturation voltage

**Housing features**

- Base isolation: Al<sub>2</sub>O<sub>3</sub>
- Convex shaped baseplate for superior thermal contact
- Cu baseplate
- Thermo-mechanical push-and-pull force relief
- Solder pin

**Target applications**

Energy Storage Systems; Solar Inverters; UPS

**Types**

- 30-FT07NIC320S501-PJ76F58

**flow 2 13 mm housing**



**Schematic**

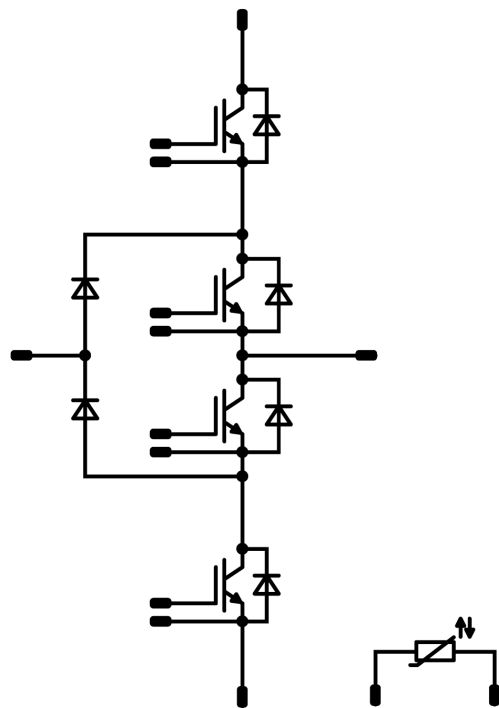



Vincotech

**30-FT07NIC320S501-PJ76F58**  
datasheet

## Maximum Ratings

$T_j = 25\text{ °C}$ , unless otherwise specified

Parameter	Symbol	Conditions	Value	Unit
<b>Buck Switch</b>				
Collector-emitter voltage	$V_{CES}$		650	V
Collector current (DC current)	$I_C$	$T_j = T_{jmax}$ $T_s = 80\text{ °C}$	285	A
Repetitive peak collector current	$I_{CRM}$	$t_p$ limited by $T_{jmax}$	960	A
Total power dissipation	$P_{tot}$	$T_j = T_{jmax}$ $T_s = 80\text{ °C}$	444	W
Gate-emitter voltage	$V_{GES}$		$\pm 20$	V
Maximum junction temperature	$T_{jmax}$		175	°C
<b>Buck Diode</b>				
Peak repetitive reverse voltage	$V_{RRM}$		650	V
Forward current (DC current)	$I_F$	$T_j = T_{jmax}$ $T_s = 80\text{ °C}$	237	A
Repetitive peak forward current	$I_{FRM}$	$t_p$ limited by $T_{jmax}$	900	A
Total power dissipation	$P_{tot}$	$T_j = T_{jmax}$ $T_s = 80\text{ °C}$	346	W
Maximum junction temperature	$T_{jmax}$		175	°C
<b>Boost Switch</b>				
Collector-emitter voltage	$V_{CES}$		650	V
Collector current (DC current)	$I_C$	$T_j = T_{jmax}$ $T_s = 80\text{ °C}$	285	A
Repetitive peak collector current	$I_{CRM}$	$t_p$ limited by $T_{jmax}$	960	A
Total power dissipation	$P_{tot}$	$T_j = T_{jmax}$ $T_s = 80\text{ °C}$	444	W
Gate-emitter voltage	$V_{GES}$		$\pm 20$	V
Maximum junction temperature	$T_{jmax}$		175	°C

**Maximum Ratings** $T_j = 25\text{ °C}$ , unless otherwise specified

Parameter	Symbol	Conditions	Value	Unit
<b>Boost Diode</b>				
Peak repetitive reverse voltage	$V_{RRM}$		650	V
Forward current (DC current)	$I_F$	$T_j = T_{jmax}$ $T_s = 80\text{ °C}$	254	A
Repetitive peak forward current	$I_{FRM}$	$t_p$ limited by $T_{jmax}$	720	A
Total power dissipation	$P_{tot}$	$T_j = T_{jmax}$ $T_s = 80\text{ °C}$	363	W
Maximum junction temperature	$T_{jmax}$		175	°C

**Boost Sw. Inv. Diode**

Peak repetitive reverse voltage	$V_{RRM}$		650	V
Forward current (DC current)	$I_F$	$T_j = T_{jmax}$ $T_s = 80\text{ °C}$	254	A
Repetitive peak forward current	$I_{FRM}$	$t_p$ limited by $T_{jmax}$	720	A
Total power dissipation	$P_{tot}$	$T_j = T_{jmax}$ $T_s = 80\text{ °C}$	363	W
Maximum junction temperature	$T_{jmax}$		175	°C

**Module Properties****Thermal Properties**

Storage temperature	$T_{stg}$		-40...+125	°C
Operation temperature under switching condition	$T_{jop}$		-40...+( $T_{jmax} - 25$ )	°C

**Isolation Properties**

Isolation voltage	$V_{isol}$	DC Test Voltage* $t_p = 2\text{ s}$	6000	V
Isolation voltage	$V_{isol}$	AC Voltage $t_p = 1\text{ min}$	2500	V
Creepage distance			>12,7	mm
Clearance			>12,7	mm
Comparative Tracking Index	CTI		≥ 600	

\*100 % tested in production



Vincotech

**30-FT07NIC320S501-PJ76F58**  
datasheet

### Characteristic Values

Parameter	Symbol	Conditions					Values			Unit
		$V_{GE}$ [V] $V_{GS}$ [V]	$V_{CE}$ [V] $V_{DS}$ [V] $V_F$ [V]	$I_C$ [A] $I_D$ [A] $I_F$ [A]	$T_j$ [°C]	Min	Typ	Max		

#### Buck Switch

##### Static

Gate-emitter threshold voltage	$V_{GE(th)}$	$V_{CE} = V_{GE}$			0,0032	25	3,2	4	4,8	V
Collector-emitter saturation voltage	$V_{CE(sat)}$		15		320	25 125 150		1,43 1,57 1,6	1,75 <sup>(1)</sup>	V
Collector-emitter cut-off current	$I_{CES}$		0	650		25			400	μA
Gate-emitter leakage current	$I_{GES}$		20	0		25			800	nA
Internal gate resistance	$r_g$							None		Ω
Input capacitance	$C_{ies}$	$f = 1 \text{ Mhz}$	0	25		25		20000		pF
Reverse transfer capacitance	$C_{res}$							72		pF

##### Thermal

Thermal resistance junction to sink <sup>(2)</sup>	$R_{th(j-s)}$	$\lambda_{paste} = 3,4 \text{ W/mK}$ (PSX)						0,21		K/W
--	---------------	---	--	--	--	--	--	------	--	-----

##### Dynamic

Turn-on delay time	$t_{d(on)}$	$R_{gon} = 2 \Omega$ $R_{goff} = 2 \Omega$	±15	350	300	25		79,3		ns
Rise time	$t_r$					125		80,7		ns
						150		81,4		
						25		16,42		
Turn-off delay time	$t_{d(off)}$					125		17,79		ns
						150		18,12		
						25		87,43		
Fall time	$t_f$	125		104,41		ns				
		150		108,52						
		25		13,44						
Turn-on energy (per pulse)	$E_{on}$	$Q_{fwd} = 7,07 \mu\text{C}$				25		3,48		mWs
		$Q_{fwd} = 14,99 \mu\text{C}$				125		4,73		
		$Q_{fwd} = 17,5 \mu\text{C}$				150		4,95		
Turn-off energy (per pulse)	$E_{off}$					25		3,11		mWs
						125		4,8		
						150		5,25		





Vincotech

**30-FT07NIC320S501-PJ76F58**  
datasheet

### Characteristic Values

Parameter	Symbol	Conditions					Values			Unit
		$V_{GE}$ [V] $V_{GS}$ [V]	$V_{CE}$ [V] $V_{DS}$ [V] $V_F$ [V]	$I_C$ [A] $I_D$ [A] $I_F$ [A]	$T_j$ [°C]	Min	Typ	Max		

#### Buck Diode

##### Static

Forward voltage	$V_F$				300	25 125 150		1,66 1,63 1,6	1,92 <sup>(1)</sup>	V
Reverse leakage current	$I_R$	$V_r = 650$ V				25			15,2	μA

##### Thermal

Thermal resistance junction to sink <sup>(2)</sup>	$R_{th(j-s)}$	$\lambda_{paste} = 3,4$ W/mK (PSX)						0,27		K/W
--	---------------	---------------------------------------	--	--	--	--	--	------	--	-----

##### Dynamic

Peak recovery current	$I_{RM}$					25 125 150		191,8 271,69 298,08		A
Reverse recovery time	$t_{rr}$					25 125 150		67,23 94,75 104,81		ns
Recovered charge	$Q_r$	$di/dt=13959$ A/μs $di/dt=14408$ A/μs $di/dt=12703$ A/μs	±15	350	300	25 125 150		7,07 14,99 17,5		μC
Reverse recovered energy	$E_{rec}$					25 125 150		1,48 3,43 4,07		mWs
Peak rate of fall of recovery current	$(di_r/dt)_{max}$					25 125 150		3480,89 3373,08 3580,7		A/μs



Vincotech

**30-FT07NIC320S501-PJ76F58**  
datasheet

### Characteristic Values

Parameter	Symbol	Conditions					Values			Unit
		$V_{GE}$ [V] $V_{GS}$ [V]	$V_{CE}$ [V] $V_{DS}$ [V] $V_F$ [V]	$I_C$ [A] $I_D$ [A] $I_F$ [A]	$T_j$ [°C]	Min	Typ	Max		

#### Boost Switch

##### Static

Gate-emitter threshold voltage	$V_{GE(th)}$	$V_{CE} = V_{GE}$			0,0032	25	3,2	4	4,8	V
Collector-emitter saturation voltage	$V_{CE(sat)}$		15		320	25 125 150		1,43 1,57 1,6	1,75 <sup>(1)</sup>	V
Collector-emitter cut-off current	$I_{CES}$		0	650		25			400	μA
Gate-emitter leakage current	$I_{GES}$		20	0		25			800	nA
Internal gate resistance	$r_g$							None		Ω
Input capacitance	$C_{ies}$	$f = 1 \text{ Mhz}$	0	25		25		20000		pF
Reverse transfer capacitance	$C_{res}$							72		pF

##### Thermal

Thermal resistance junction to sink <sup>(2)</sup>	$R_{th(j-s)}$	$\lambda_{paste} = 3,4 \text{ W/mK}$ (PSX)						0,21		K/W
--	---------------	---	--	--	--	--	--	------	--	-----

##### Dynamic

Turn-on delay time	$t_{d(on)}$	$R_{gon} = 2 \Omega$ $R_{goff} = 2 \Omega$	±15	350	300	25		82,7		ns				
						125		84,2						
						150		84,57						
Rise time	$t_r$									25		16,2		ns
										125		18,21		
										150		18,69		
Turn-off delay time	$t_{d(off)}$									25		84,7		ns
						125		101,39						
						150		105,95						
Fall time	$t_f$					25		13,31		ns				
						125		26,53						
						150		30,31						
Turn-on energy (per pulse)	$E_{on}$	$Q_{fwd} = 7,13 \mu\text{C}$ $Q_{fwd} = 14,14 \mu\text{C}$ $Q_{fwd} = 16,24 \mu\text{C}$				25		2,3		mWs				
						125		2,76						
						150		2,86						
Turn-off energy (per pulse)	$E_{off}$					25		3,59		mWs				
						125		5,57						
						150		6,02						



Vincotech

### Characteristic Values

Parameter	Symbol	Conditions					Values			Unit
		$V_{GE}$ [V] $V_{GS}$ [V]	$V_{CE}$ [V] $V_{DS}$ [V] $V_F$ [V]	$I_C$ [A] $I_D$ [A] $I_F$ [A]	$T_j$ [°C]	Min	Typ	Max		
<b>Boost Diode</b>										
<b>Static</b>										
Forward voltage	$V_F$			240	25 125 150		1,53 1,46 1,43	1,92 <sup>(1)</sup>		V
Reverse leakage current	$I_R$	$V_r = 650$ V			25			12,8		μA
<b>Thermal</b>										
Thermal resistance junction to sink <sup>(2)</sup>	$R_{th(j-s)}$	$\lambda_{paste} = 3,4$ W/mK (PSX)					0,26			K/W
<b>Dynamic</b>										
Peak recovery current	$I_{RM}$				25 125 150		189,35 250,58 267,71			A
Reverse recovery time	$t_{rr}$				25 125 150		68,76 105,57 117,78			ns
Recovered charge	$Q_r$	$di/dt=14869$ A/μs $di/dt=13339$ A/μs $di/dt=13176$ A/μs	±15	350	300	25 125 150	7,13 14,14 16,24			μC
Reverse recovered energy	$E_{rec}$				25 125 150		1,53 3,14 3,6			mWs
Peak rate of fall of recovery current	$(di_r/dt)_{max}$				25 125 150		3043,21 2513,7 2618,43			A/μs



### Characteristic Values

Parameter	Symbol	Conditions					Values			Unit
		$V_{GE}$ [V] $V_{GS}$ [V]	$V_{CE}$ [V] $V_{DS}$ [V] $V_F$ [V]	$I_C$ [A] $I_D$ [A] $I_F$ [A]	$T_j$ [°C]	Min	Typ	Max		

#### Boost Sw. Inv. Diode

##### Static

Forward voltage	$V_F$				240	25 125 150		1,53 1,46 1,43	1,92 <sup>(1)</sup>	V
Reverse leakage current	$I_R$	$V_r = 650$ V				25			12,8	μA

##### Thermal

Thermal resistance junction to sink <sup>(2)</sup>	$R_{th(j-s)}$	$\lambda_{paste} = 3,4$ W/mK (PSX)						0,26		K/W
--	---------------	---------------------------------------	--	--	--	--	--	------	--	-----

#### Thermistor

##### Static

Rated resistance	$R$					25		22		kΩ
Deviation of R100	$\Delta_{R/R}$	$R_{100} = 1484$ Ω				100	-5		5	%
Power dissipation	$P$					25		130		mW
Power dissipation constant	$d$					25		1,5		mW/K
B-value	$B_{(25/50)}$	Tol. ±1 %						3962		K
B-value	$B_{(25/100)}$	Tol. ±1 %						4000		K
Vincotech Thermistor Reference									I	

<sup>(1)</sup> Value at chip level

<sup>(2)</sup> Only valid with pre-applied Vincotech thermal interface material.



## Buck Switch Characteristics

**figure 1.** IGBT

Typical output characteristics

$$I_C = f(V_{CE})$$

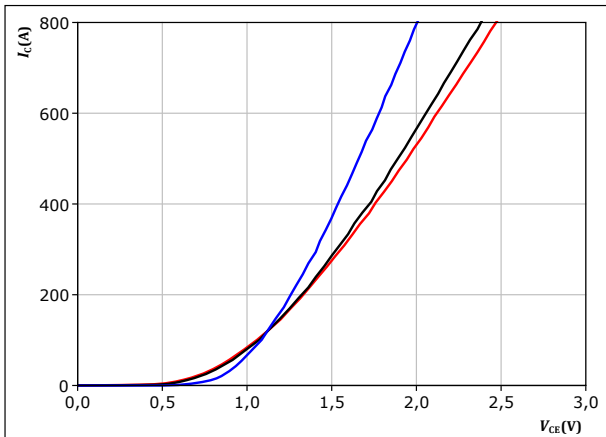

$t_p = 250 \mu s$   
 $V_{GE} = 14 V$

$T_j$ : 25 °C (blue), 125 °C (black), 150 °C (red)

**figure 2.** IGBT

Typical output characteristics

$$I_C = f(V_{CE})$$

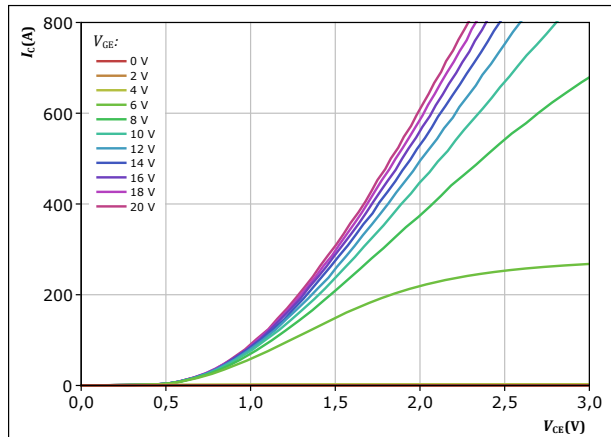

$t_p = 250 \mu s$   
 $T_j = 150 \text{ °C}$   
 $V_{GE}$  from 0 V to 20 V in steps of 2 V

**figure 3.** IGBT

Typical transfer characteristics

$$I_C = f(V_{GE})$$

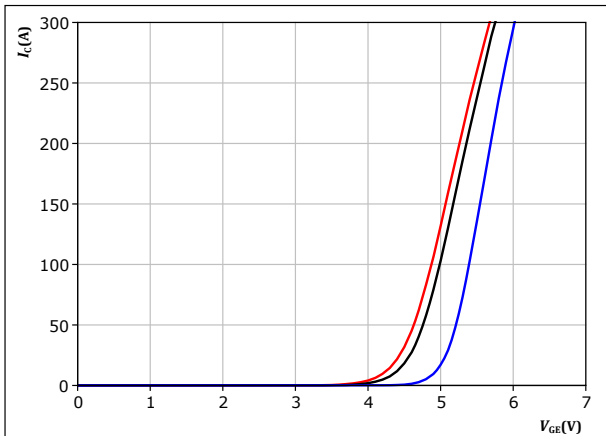

$t_p = 250 \mu s$   
 $V_{CE} = 55 V$

$T_j$ : 25 °C (blue), 125 °C (black), 150 °C (red)

**figure 4.** IGBT

Transient thermal impedance as a function of pulse width

$$Z_{th(j-s)} = f(t_p)$$

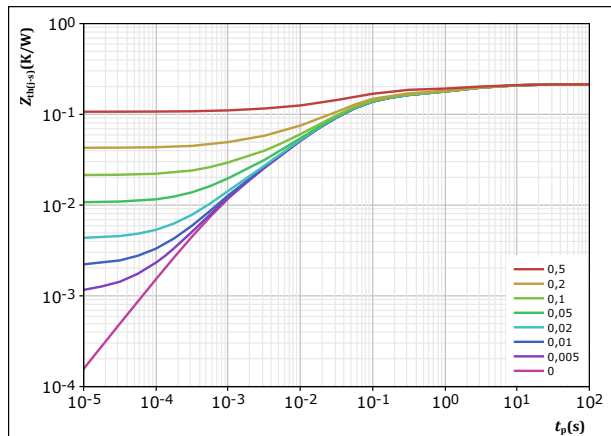

$D = t_p / T$   
 $R_{th(j-s)} = 0,214 \text{ K/W}$

IGBT thermal model values

$R$ (K/W)	$\tau$ (s)
2,36E-02	6,25E+00
3,62E-02	1,16E+00
1,05E-01	5,88E-02
3,87E-02	1,02E-02
1,00E-02	9,95E-04



### Buck Switch Characteristics

figure 5. IGBT

Safe operating area

$$I_C = f(V_{CE})$$

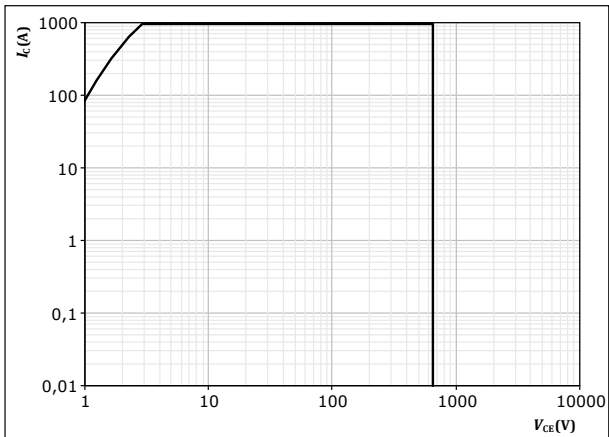

$D =$  single pulse  
 $T_s = 80 \text{ } ^\circ\text{C}$   
 $V_{CE} = 14 \text{ V}$   
 $T_j = T_{jmax}$



### Buck Diode Characteristics

figure 6. FWD

Typical forward characteristics

$$I_F = f(V_F)$$

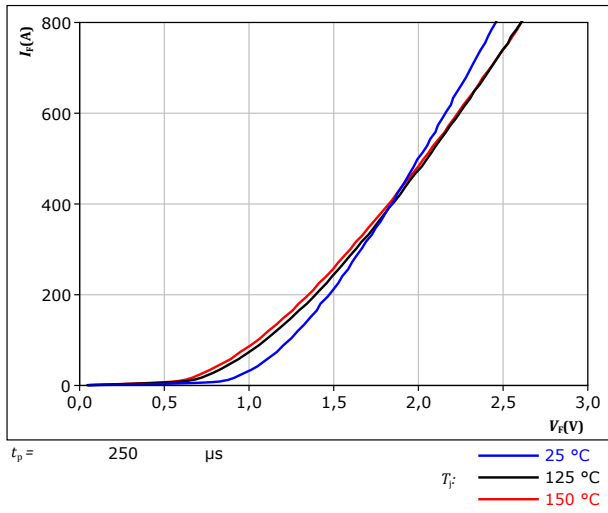
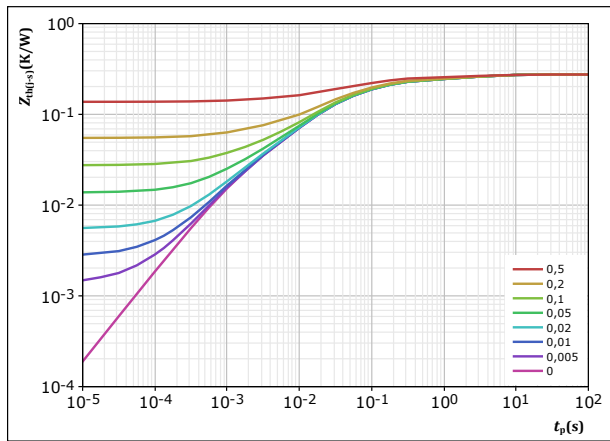

figure 7. FWD

Transient thermal impedance as a function of pulse width

$$Z_{th(j-s)} = f(t_p)$$



$D = \frac{t_p}{T}$   
 $R_{th(j-s)} = 0,275 \text{ K/W}$   
 FWD thermal model values

R (K/W)	$\tau$ (s)
2,62E-02	4,51E+00
2,75E-02	8,53E-01
1,18E-01	8,44E-02
8,67E-02	1,56E-02
1,65E-02	1,38E-03



### Boost Switch Characteristics

figure 8. IGBT

Typical output characteristics

$$I_C = f(V_{CE})$$

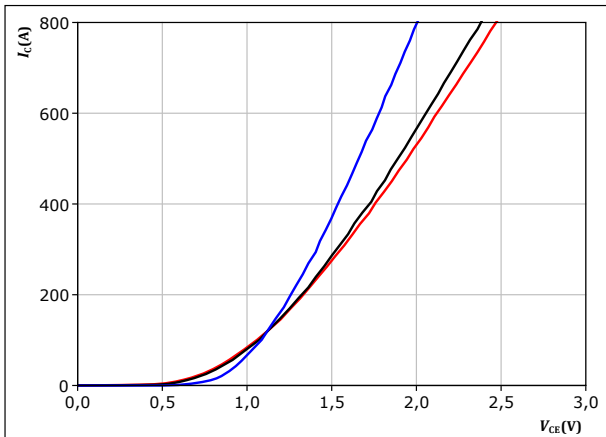

$t_p = 250 \mu s$   
 $V_{GE} = 14 V$   
 $T_j:$  25 °C, 125 °C, 150 °C

figure 9. IGBT

Typical output characteristics

$$I_C = f(V_{CE})$$

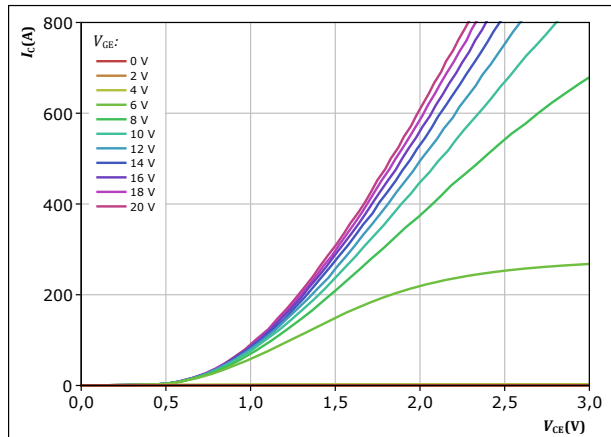

$t_p = 250 \mu s$   
 $T_j = 150 \text{ °C}$   
 $V_{GE}$  from 0 V to 20 V in steps of 2 V

figure 10. IGBT

Typical transfer characteristics

$$I_C = f(V_{GE})$$

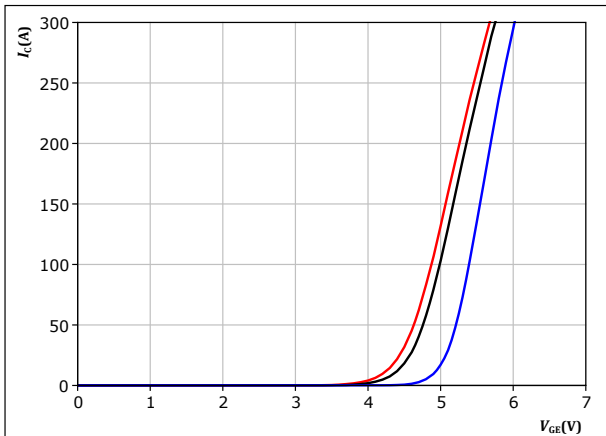

$t_p = 250 \mu s$   
 $V_{CE} = 55 V$   
 $T_j:$  25 °C, 125 °C, 150 °C

figure 11. IGBT

Transient thermal impedance as a function of pulse width

$$Z_{th(j-s)} = f(t_p)$$

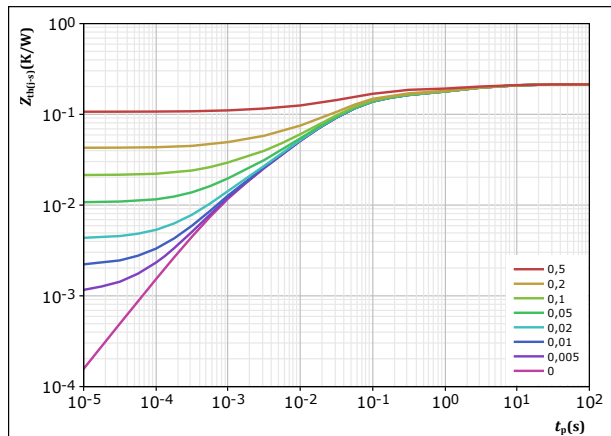

$D = t_p / T$   
 $R_{th(j-s)} = 0,214 \text{ K/W}$   
IGBT thermal model values  

$R$ (K/W)	$\tau$ (s)
2,36E-02	6,25E+00
3,62E-02	1,16E+00
1,05E-01	5,88E-02
3,87E-02	1,02E-02
1,00E-02	9,95E-04





### Boost Switch Characteristics

figure 12. IGBT

Safe operating area

$$I_C = f(V_{CE})$$

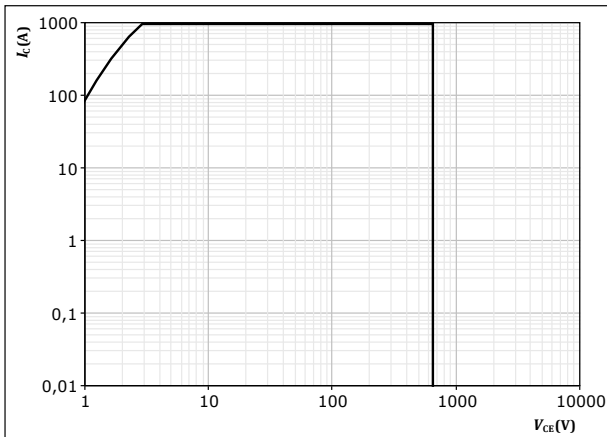

$D =$  single pulse  
 $T_s = 80$  °C  
 $V_{GE} = 14$  V  
 $T_j = T_{jmax}$



### Boost Diode Characteristics

figure 13. FWD

Typical forward characteristics

$$I_F = f(V_F)$$

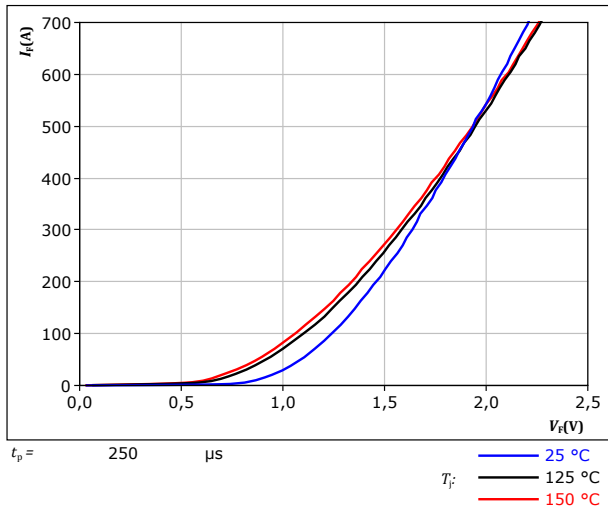
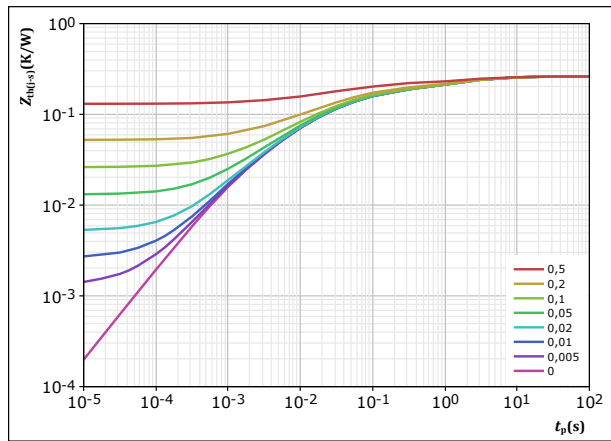

figure 14. FWD

Transient thermal impedance as a function of pulse width

$$Z_{th(j-s)} = f(t_p)$$



$D = \frac{t_p}{T}$   
 $R_{th(j-s)} = 0,262 \text{ K/W}$   
 FWD thermal model values

R (K/W)	$\tau$ (s)
2,89E-02	6,06E+00
5,91E-02	1,13E+00
9,21E-02	6,58E-02
6,69E-02	9,86E-03
1,45E-02	1,25E-03



### Boost Sw. Inv. Diode Characteristics

figure 15. FWD

Typical forward characteristics

$$I_F = f(V_F)$$

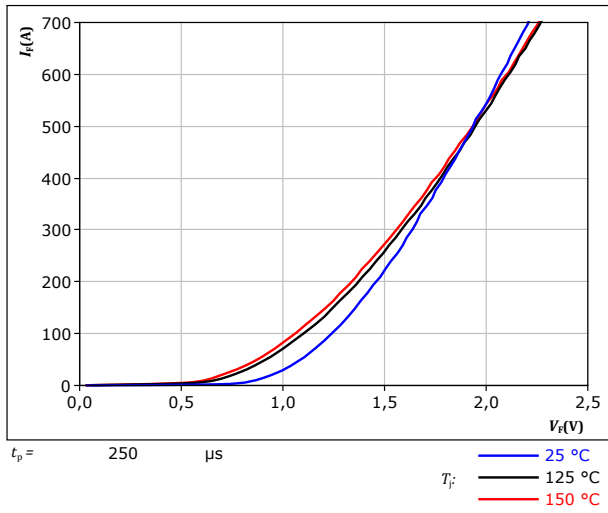
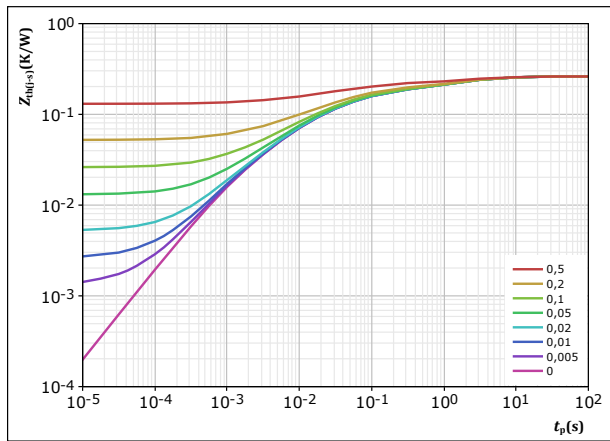

figure 16. FWD

Transient thermal impedance as a function of pulse width

$$Z_{th(j-s)} = f(t_p)$$



$D = t_p / T$   
 $R_{th(j-s)} = 0,262 \text{ K/W}$   
 FWD thermal model values

R (K/W)	$\tau$ (s)
2,89E-02	6,06E+00
5,91E-02	1,13E+00
9,21E-02	6,58E-02
6,69E-02	9,86E-03
1,45E-02	1,25E-03



### Thermistor Characteristics

figure 17. Thermistor

Typical NTC characteristic as function of temperature

$$R_T = f(T)$$

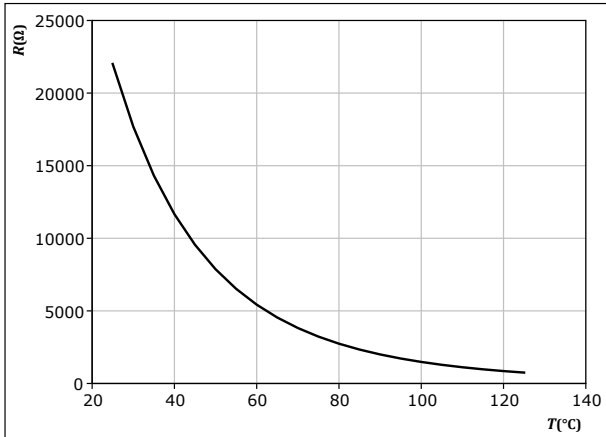



## Buck Switching Characteristics

**figure 18.** IGBT

Typical switching energy losses as a function of collector current

$$E = f(I_c)$$

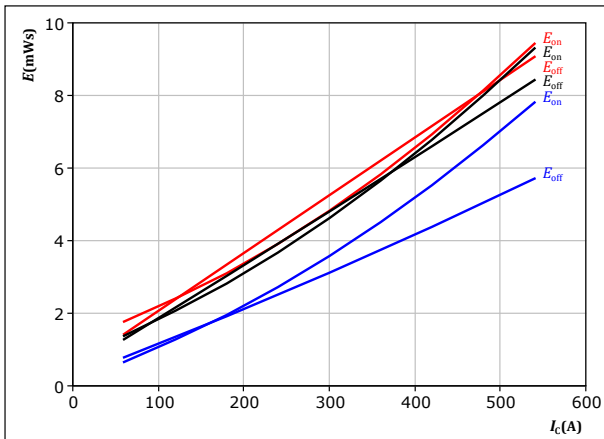

With an inductive load at

$V_{CE} = 350$  V  
 $V_{GE} = \pm 15$  V  
 $R_{gon} = 2$   $\Omega$   
 $R_{goff} = 2$   $\Omega$

$T_j$ : — 25 °C  
— 125 °C  
— 150 °C

**figure 19.** IGBT

Typical switching energy losses as a function of IGBT turn on gate resistor

$$E = f(R_g)$$

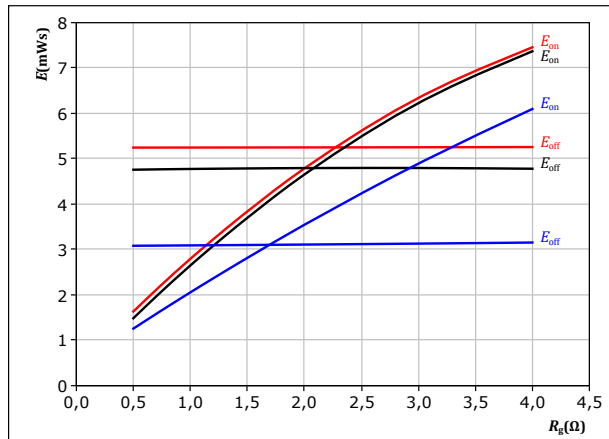

With an inductive load at

$V_{CE} = 350$  V  
 $V_{GE} = \pm 15$  V  
 $I_c = 300$  A

$T_j$ : — 25 °C  
— 125 °C  
— 150 °C

**figure 20.** FWD

Typical reverse recovered energy loss as a function of collector current

$$E_{rec} = f(I_c)$$

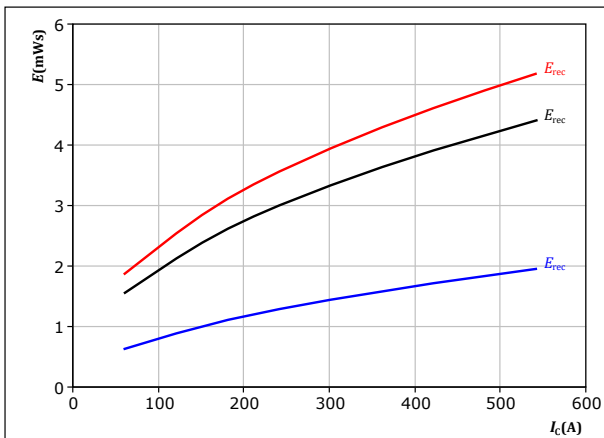

With an inductive load at

$V_{CE} = 350$  V  
 $V_{GE} = \pm 15$  V  
 $R_{gon} = 2$   $\Omega$

$T_j$ : — 25 °C  
— 125 °C  
— 150 °C

**figure 21.** FWD

Typical reverse recovered energy loss as a function of IGBT turn on gate resistor

$$E_{rec} = f(R_g)$$

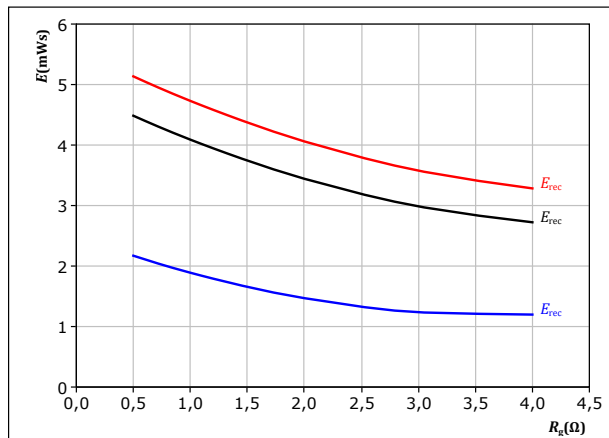

With an inductive load at

$V_{CE} = 350$  V  
 $V_{GE} = \pm 15$  V  
 $I_c = 300$  A

$T_j$ : — 25 °C  
— 125 °C  
— 150 °C



## Buck Switching Characteristics

**figure 22.** IGBT

Typical switching times as a function of collector current  
 $t = f(I_c)$

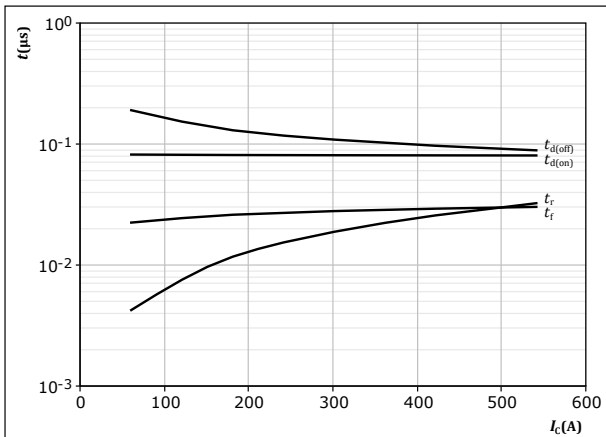

With an inductive load at  
 $T_j = 150 \text{ }^\circ\text{C}$   
 $V_{CE} = 350 \text{ V}$   
 $V_{GE} = \pm 15 \text{ V}$   
 $R_{gon} = 2 \text{ } \Omega$   
 $R_{goff} = 2 \text{ } \Omega$

**figure 23.** IGBT

Typical switching times as a function of IGBT turn on gate resistor  
 $t = f(R_g)$

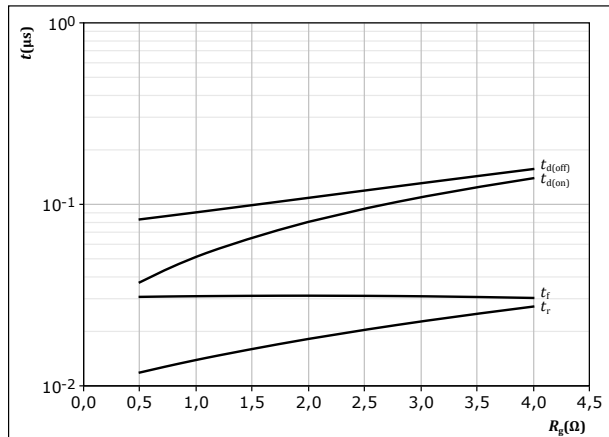

With an inductive load at  
 $T_j = 150 \text{ }^\circ\text{C}$   
 $V_{CE} = 350 \text{ V}$   
 $V_{GE} = \pm 15 \text{ V}$   
 $I_c = 300 \text{ A}$

**figure 24.** FWD

Typical reverse recovery time as a function of collector current  
 $t_{rr} = f(I_c)$

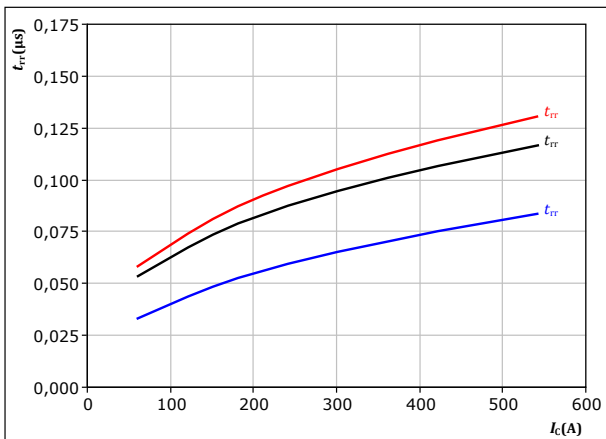

With an inductive load at  
 $V_{CE} = 350 \text{ V}$   
 $V_{GE} = \pm 15 \text{ V}$   
 $R_{gon} = 2 \text{ } \Omega$   
 $T_j: \text{ } \text{---} 25 \text{ }^\circ\text{C}$   
 $\text{---} 125 \text{ }^\circ\text{C}$   
 $\text{---} 150 \text{ }^\circ\text{C}$

**figure 25.** FWD

Typical reverse recovery time as a function of IGBT turn on gate resistor  
 $t_{rr} = f(R_{gon})$

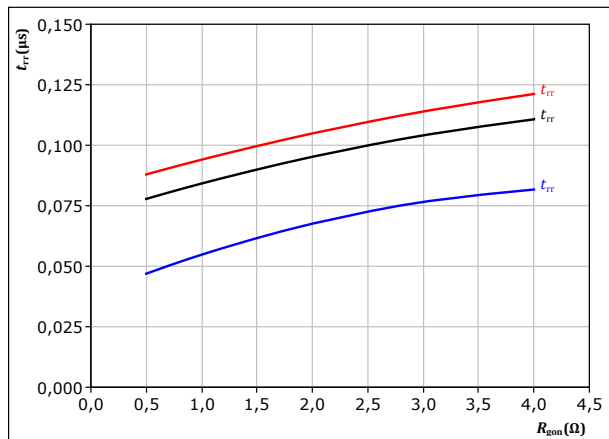

With an inductive load at  
 $V_{CE} = 350 \text{ V}$   
 $V_{GE} = \pm 15 \text{ V}$   
 $I_c = 300 \text{ A}$   
 $T_j: \text{ } \text{---} 25 \text{ }^\circ\text{C}$   
 $\text{---} 125 \text{ }^\circ\text{C}$   
 $\text{---} 150 \text{ }^\circ\text{C}$



## Buck Switching Characteristics

**figure 26.** FWD

Typical recovered charge as a function of collector current

$$Q_r = f(I_c)$$

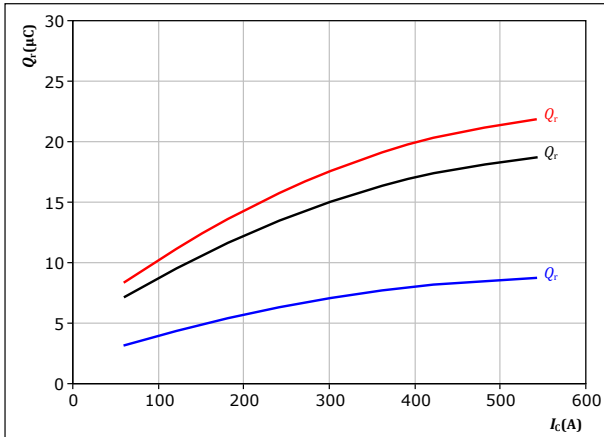

With an inductive load at

$V_{CE} = 350 \text{ V}$   
 $V_{GE} = \pm 15 \text{ V}$   
 $R_{gon} = 2 \ \Omega$

$T_j$ : 25 °C (blue)  
 125 °C (black)  
 150 °C (red)

**figure 27.** FWD

Typical recovered charge as a function of IGBT turn on gate resistor

$$Q_r = f(R_{gon})$$

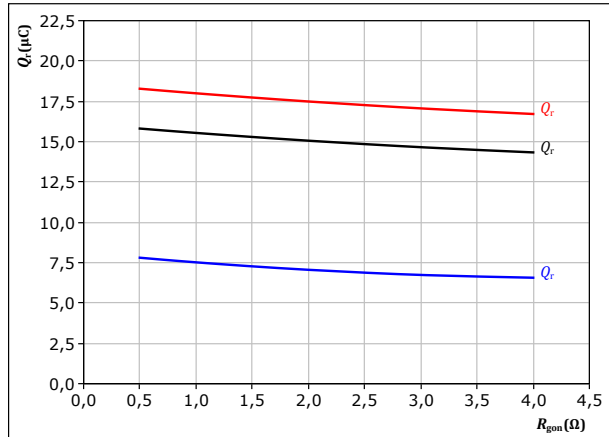

With an inductive load at

$V_{CE} = 350 \text{ V}$   
 $V_{GE} = \pm 15 \text{ V}$   
 $I_c = 300 \text{ A}$

$T_j$ : 25 °C (blue)  
 125 °C (black)  
 150 °C (red)

**figure 28.** FWD

Typical peak reverse recovery current as a function of collector current

$$I_{RM} = f(I_c)$$

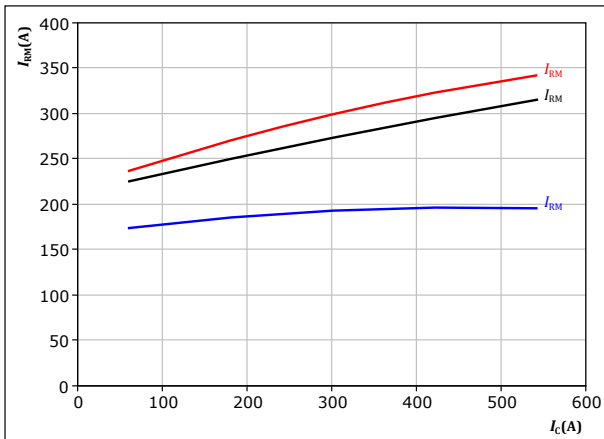

With an inductive load at

$V_{CE} = 350 \text{ V}$   
 $V_{GE} = \pm 15 \text{ V}$   
 $R_{gon} = 2 \ \Omega$

$T_j$ : 25 °C (blue)  
 125 °C (black)  
 150 °C (red)

**figure 29.** FWD

Typical peak reverse recovery current as a function of IGBT turn on gate resistor

$$I_{RM} = f(R_{gon})$$

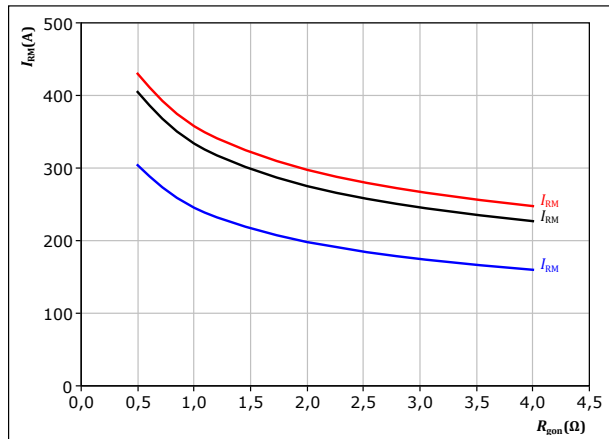

With an inductive load at

$V_{CE} = 350 \text{ V}$   
 $V_{GE} = \pm 15 \text{ V}$   
 $I_c = 300 \text{ A}$

$T_j$ : 25 °C (blue)  
 125 °C (black)  
 150 °C (red)



## Buck Switching Characteristics

**figure 30.** FWD

Typical rate of fall of forward and reverse recovery current as a function of collector current  
 $di_f/dt, di_{rr}/dt = f(I_C)$

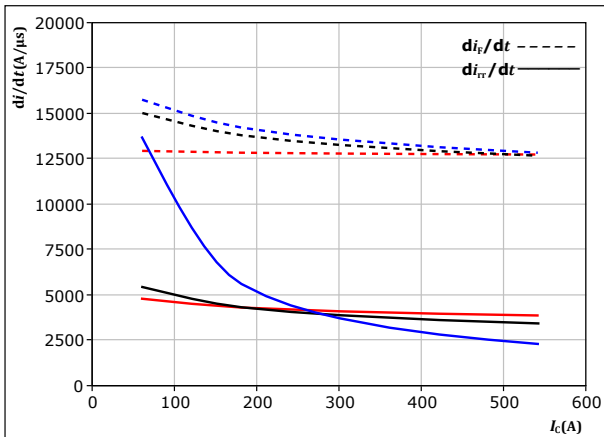

With an inductive load at

$V_{CE} = 350$  V  
 $V_{GE} = \pm 15$  V  
 $R_{gon} = 2$   $\Omega$

$T_j$ : — 25 °C  
 — 125 °C  
 — 150 °C

**figure 31.** FWD

Typical rate of fall of forward and reverse recovery current as a function of turn on gate resistor  
 $di_f/dt, di_{rr}/dt = f(R_{gon})$

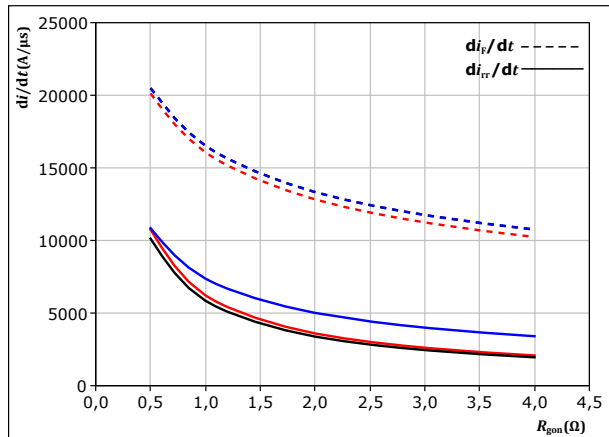

With an inductive load at

$V_{CE} = 350$  V  
 $V_{GE} = \pm 15$  V  
 $I_C = 300$  A

$T_j$ : — 25 °C  
 — 125 °C  
 — 150 °C

**figure 32.** IGBT

Reverse bias safe operating area

$I_C = f(V_{CE})$

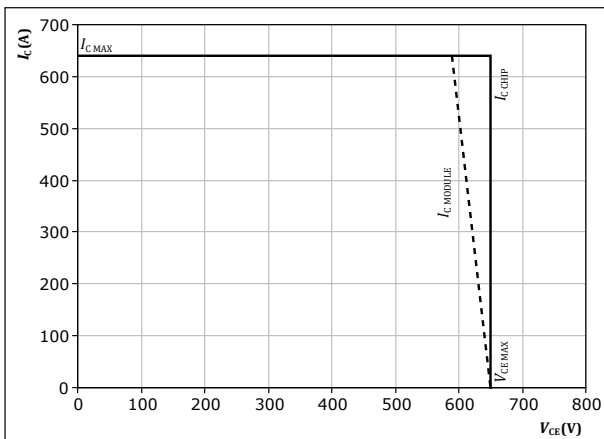

At  $T_j = 150$  °C  
 $R_{gon} = 2$   $\Omega$   
 $R_{goff} = 2$   $\Omega$





## Boost Switching Characteristics

**figure 33.** IGBT

Typical switching energy losses as a function of collector current  
 $E = f(I_c)$

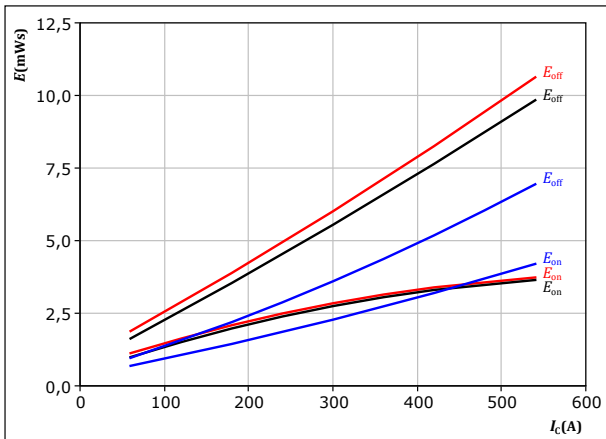

With an inductive load at

$V_{CE} = 350 \text{ V}$   
 $V_{GE} = \pm 15 \text{ V}$   
 $R_{gon} = 2 \text{ } \Omega$   
 $R_{goff} = 2 \text{ } \Omega$

$T_j$ :  $25 \text{ } ^\circ\text{C}$  (blue)  
 $125 \text{ } ^\circ\text{C}$  (black)  
 $150 \text{ } ^\circ\text{C}$  (red)

**figure 34.** IGBT

Typical switching energy losses as a function of IGBT turn on gate resistor  
 $E = f(R_g)$

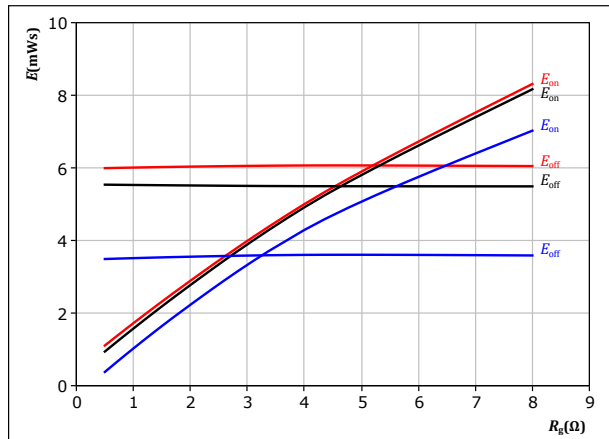

With an inductive load at

$V_{CE} = 350 \text{ V}$   
 $V_{GE} = \pm 15 \text{ V}$   
 $I_c = 300 \text{ A}$

$T_j$ :  $25 \text{ } ^\circ\text{C}$  (blue)  
 $125 \text{ } ^\circ\text{C}$  (black)  
 $150 \text{ } ^\circ\text{C}$  (red)

**figure 35.** FWD

Typical reverse recovered energy loss as a function of collector current  
 $E_{rec} = f(I_c)$

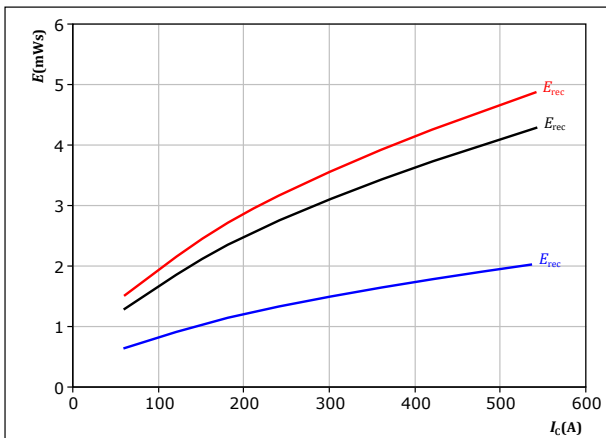

With an inductive load at

$V_{CE} = 350 \text{ V}$   
 $V_{GE} = \pm 15 \text{ V}$   
 $R_{gon} = 2 \text{ } \Omega$

$T_j$ :  $25 \text{ } ^\circ\text{C}$  (blue)  
 $125 \text{ } ^\circ\text{C}$  (black)  
 $150 \text{ } ^\circ\text{C}$  (red)

**figure 36.** FWD

Typical reverse recovered energy loss as a function of IGBT turn on gate resistor  
 $E_{rec} = f(R_g)$

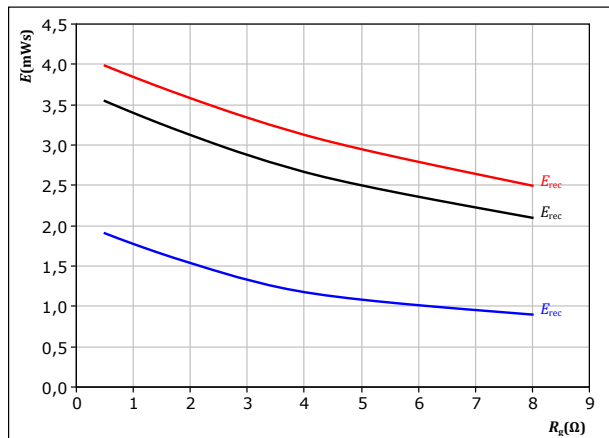

With an inductive load at

$V_{CE} = 350 \text{ V}$   
 $V_{GE} = \pm 15 \text{ V}$   
 $I_c = 300 \text{ A}$

$T_j$ :  $25 \text{ } ^\circ\text{C}$  (blue)  
 $125 \text{ } ^\circ\text{C}$  (black)  
 $150 \text{ } ^\circ\text{C}$  (red)



## Boost Switching Characteristics

**figure 37.** IGBT

Typical switching times as a function of collector current  
 $t = f(I_c)$

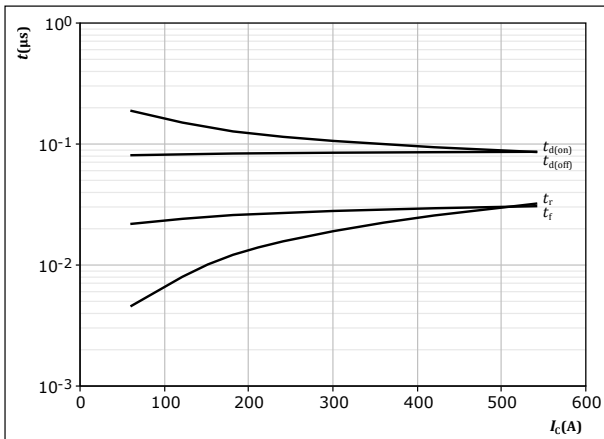

With an inductive load at  
 $T_j = 150 \text{ }^\circ\text{C}$   
 $V_{CE} = 350 \text{ V}$   
 $V_{GE} = \pm 15 \text{ V}$   
 $R_{gon} = 2 \text{ } \Omega$   
 $R_{goff} = 2 \text{ } \Omega$

**figure 38.** IGBT

Typical switching times as a function of IGBT turn on gate resistor  
 $t = f(R_g)$

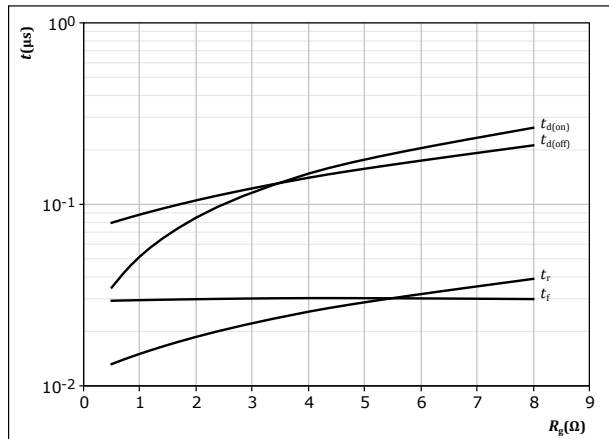

With an inductive load at  
 $T_j = 150 \text{ }^\circ\text{C}$   
 $V_{CE} = 350 \text{ V}$   
 $V_{GE} = \pm 15 \text{ V}$   
 $I_c = 300 \text{ A}$

**figure 39.** FWD

Typical reverse recovery time as a function of collector current  
 $t_{rr} = f(I_c)$

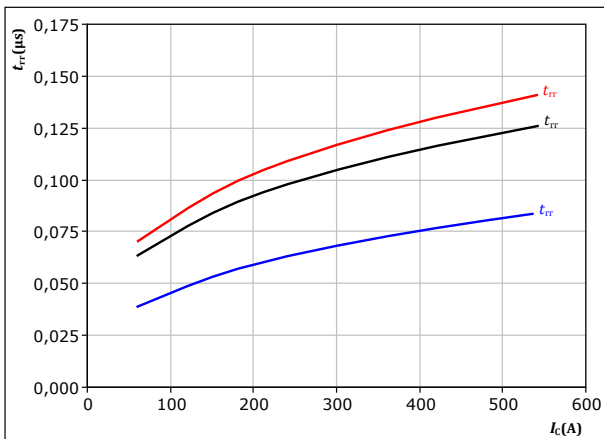

With an inductive load at  
 $V_{CE} = 350 \text{ V}$   
 $V_{GE} = \pm 15 \text{ V}$   
 $R_{gon} = 2 \text{ } \Omega$   
 $T_j: \text{ } \text{---} 25 \text{ }^\circ\text{C}$   
 $\text{---} 125 \text{ }^\circ\text{C}$   
 $\text{---} 150 \text{ }^\circ\text{C}$

**figure 40.** FWD

Typical reverse recovery time as a function of IGBT turn on gate resistor  
 $t_{rr} = f(R_{gon})$

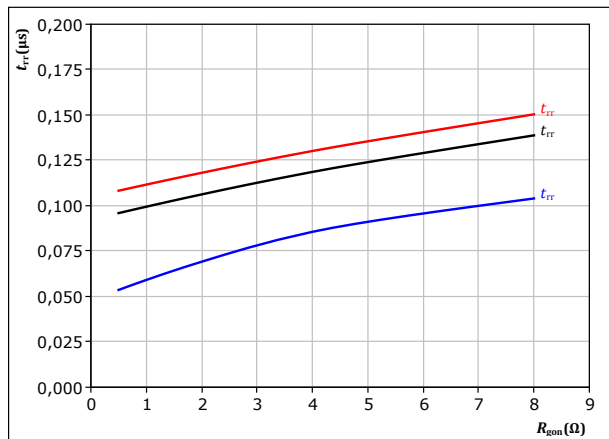

With an inductive load at  
 $V_{CE} = 350 \text{ V}$   
 $V_{GE} = \pm 15 \text{ V}$   
 $I_c = 300 \text{ A}$   
 $T_j: \text{ } \text{---} 25 \text{ }^\circ\text{C}$   
 $\text{---} 125 \text{ }^\circ\text{C}$   
 $\text{---} 150 \text{ }^\circ\text{C}$



## Boost Switching Characteristics

figure 41. FWD

Typical recovered charge as a function of collector current

$$Q_r = f(I_c)$$

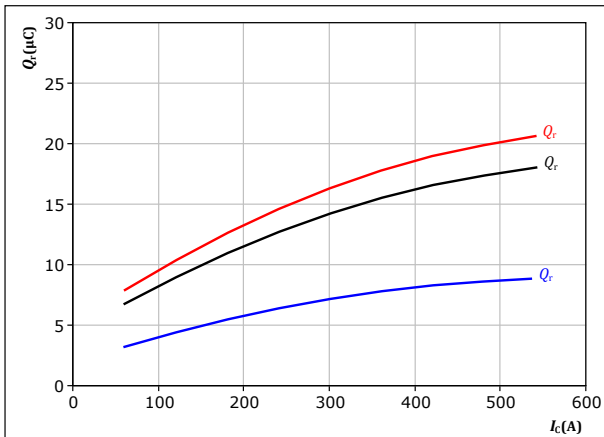

With an inductive load at

$V_{CE} = 350$  V  
 $V_{GE} = \pm 15$  V  
 $R_{g(on)} = 2$  Ω  
 $T_j$ : 25 °C (blue), 125 °C (black), 150 °C (red)

figure 42. FWD

Typical recovered charge as a function of IGBT turn on gate resistor

$$Q_r = f(R_{g(on)})$$

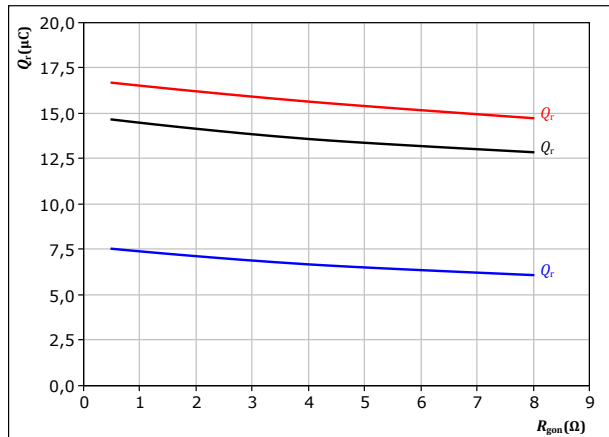

With an inductive load at

$V_{CE} = 350$  V  
 $V_{GE} = \pm 15$  V  
 $I_c = 300$  A  
 $T_j$ : 25 °C (blue), 125 °C (black), 150 °C (red)

figure 43. FWD

Typical peak reverse recovery current as a function of collector current

$$I_{RM} = f(I_c)$$

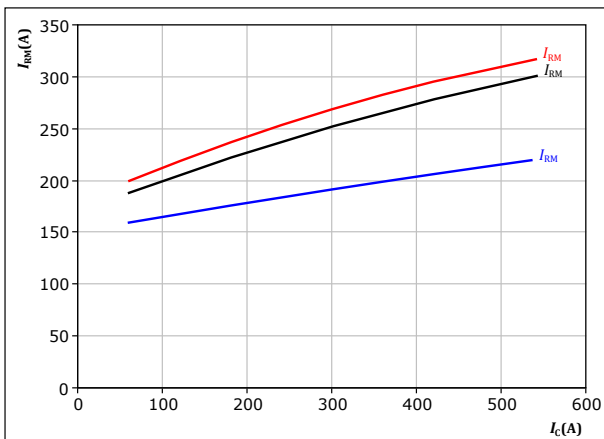

With an inductive load at

$V_{CE} = 350$  V  
 $V_{GE} = \pm 15$  V  
 $R_{g(on)} = 2$  Ω  
 $T_j$ : 25 °C (blue), 125 °C (black), 150 °C (red)

figure 44. FWD

Typical peak reverse recovery current as a function of IGBT turn on gate resistor

$$I_{RM} = f(R_{g(on)})$$

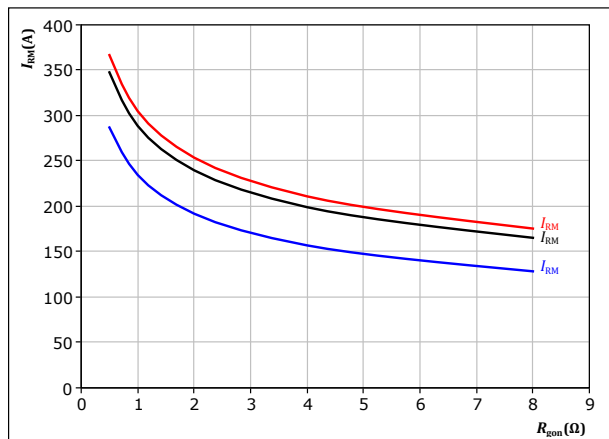

With an inductive load at

$V_{CE} = 350$  V  
 $V_{GE} = \pm 15$  V  
 $I_c = 300$  A  
 $T_j$ : 25 °C (blue), 125 °C (black), 150 °C (red)



## Boost Switching Characteristics

**figure 45.** FWD

Typical rate of fall of forward and reverse recovery current as a function of collector current  
 $di_f/dt, di_{rr}/dt = f(I_c)$

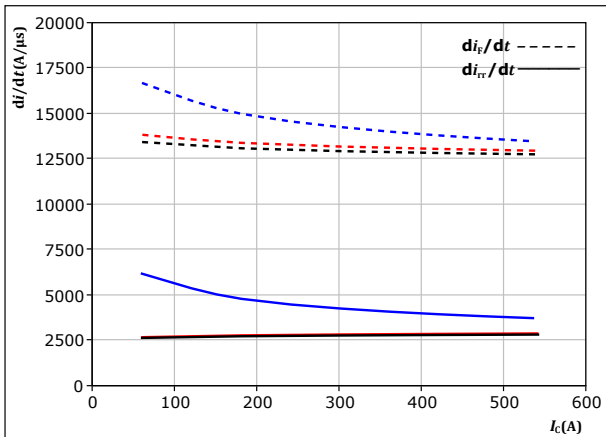

With an inductive load at

$V_{CE} = 350$  V  
 $V_{GE} = \pm 15$  V  
 $R_{gon} = 2$   $\Omega$

$T_j$ : — 25 °C  
 — 125 °C  
 — 150 °C

**figure 46.** FWD

Typical rate of fall of forward and reverse recovery current as a function of turn on gate resistor  
 $di_f/dt, di_{rr}/dt = f(R_{gon})$

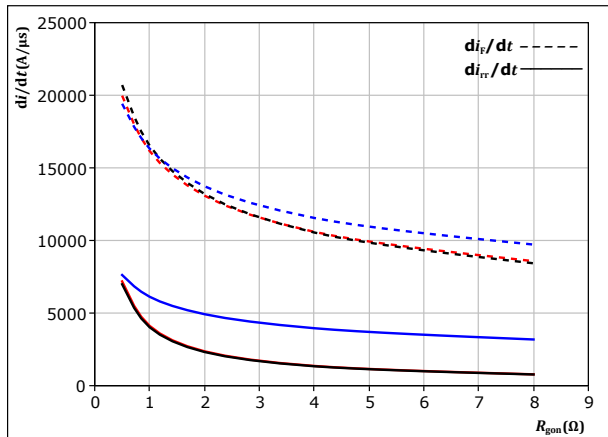

With an inductive load at

$V_{CE} = 350$  V  
 $V_{GE} = \pm 15$  V  
 $I_c = 300$  A

$T_j$ : — 25 °C  
 — 125 °C  
 — 150 °C

**figure 47.** IGBT

Reverse bias safe operating area

$I_c = f(V_{CE})$

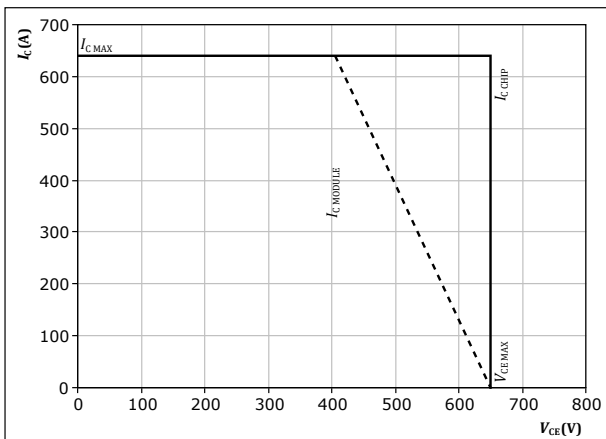

At  $T_j = 150$  °C  
 $R_{gon} = 2$   $\Omega$   
 $R_{goff} = 2$   $\Omega$



## Switching Definitions

figure 48. IGBT

Turn-off Switching Waveforms & definition of  $t_{doff}$ ,  $t_{Eoff}$  ( $t_{Eoff}$  = integrating time for  $E_{off}$ )

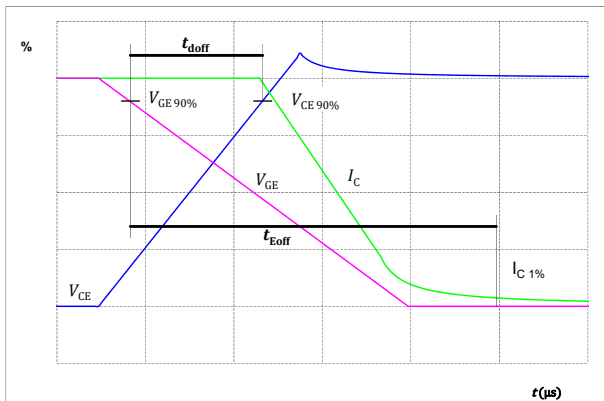

figure 49. IGBT

Turn-on Switching Waveforms & definition of  $t_{don}$ ,  $t_{Eon}$  ( $t_{Eon}$  = integrating time for  $E_{on}$ )

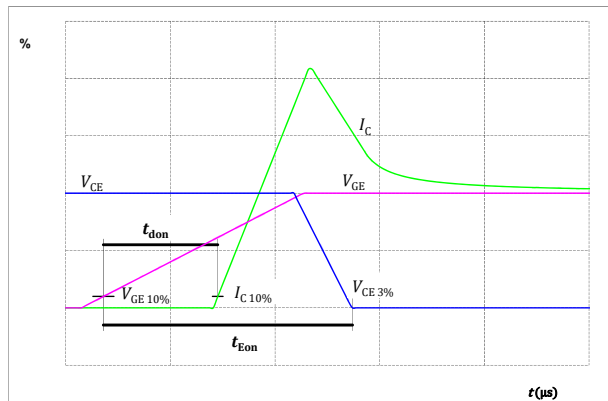

figure 50. IGBT

Turn-off Switching Waveforms & definition of  $t_f$

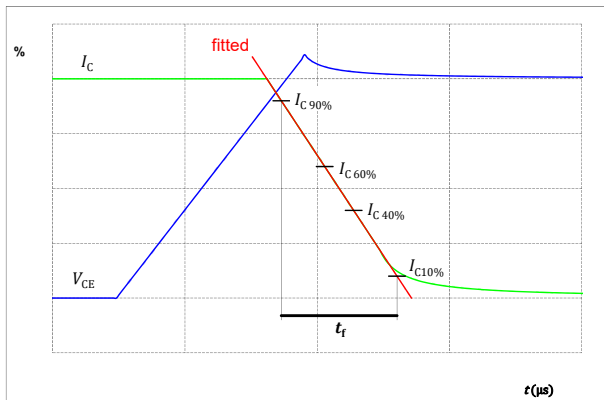
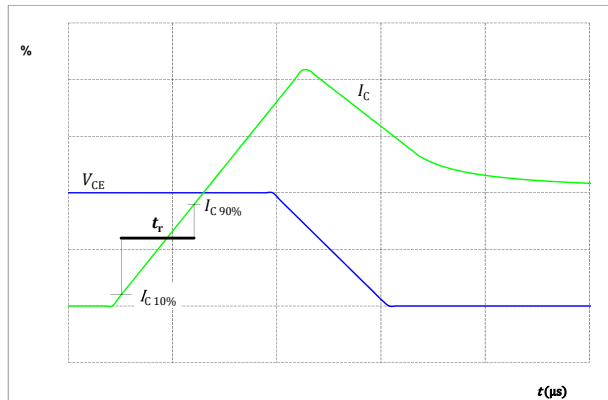

figure 51. IGBT

Turn-on Switching Waveforms & definition of  $t_r$





### Switching Definitions

figure 52. FWD

Turn-off Switching Waveforms & definition of  $t_{rr}$

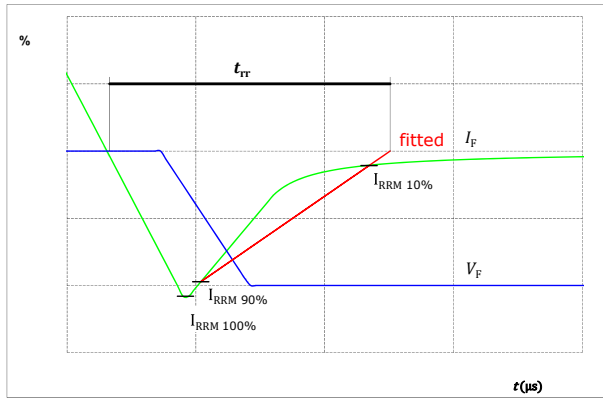
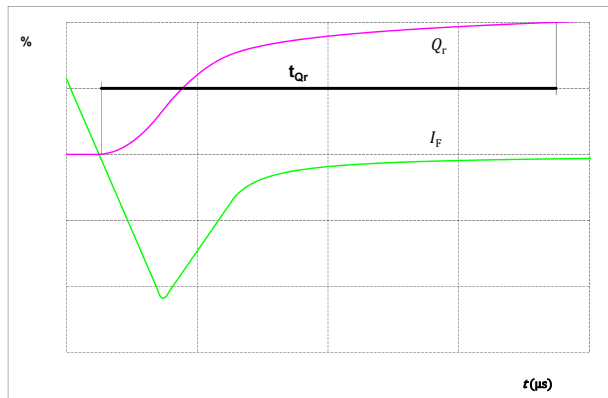

figure 53. FWD

Turn-on Switching Waveforms & definition of  $t_{Qr}$  ( $t_{Qr}$  = integrating time for  $Q_r$ )





Vincotech

**30-FT07NIC320S501-PJ76F58**  
datasheet

Ordering Code	
<b>Version</b>	<b>Ordering Code</b>
Without thermal paste	30-FT07NIC320S501-PJ76F58
With thermal paste (3,4 W/mK, PSX-P7)	30-FT07NIC320S501-PJ76F58-/3/

Marking							
	<b>Text</b>	<b>Name</b> NN-NNNNNNNNNNNNNN- TTTTTVV		<b>Date code</b> WWYY	<b>UL &amp; VIN</b> UL VIN	<b>Lot</b> LLLLL	<b>Serial</b> SSSS
	<b>Datamatrix</b>	<b>Type&amp;Ver</b> TTTTTTVV	<b>Lot number</b> LLLLL	<b>Serial</b> SSSS	<b>Date code</b> WWYY		

Outline							
Pin table [mm]							
Pin	X	Y	Function	37	65,5	15,75	S11-4
1	12,1	2,7	DC-1	38	71,1	15,75	S11-4
2	21	2,7	DC-2	39	12,3	8,1	G12-1
3	50,1	2,7	DC-3	40	20,8	8,1	G12-2
4	59	2,7	DC-4	41	50,3	8,1	G12-3
5	7,65	0	GND1	42	58,8	8,1	G12-4
6	16,55	0	GND1	43	12,3	5,4	S12-1
7	25,45	0	GND1	44	20,8	5,4	S12-2
8	45,65	0	GND2	45	50,3	5,4	S12-3
9	54,55	0	GND2	46	58,8	5,4	S12-4
10	63,45	0	GND2	47	2,8	29,2	G13-1
11	3,2	2,7	DC+1	48	30,3	29,2	G13-2
12	29,9	2,7	DC+2	49	40,8	29,2	G13-3
13	41,2	2,7	DC+3	50	68,3	29,2	G13-4
14	67,9	2,7	DC+4	51	0	29,2	S13-1
15	0	33,95	Ph-1	52	5,6	29,2	S13-1
16	2,8	33,95	Ph-1	53	27,5	29,2	S13-2
17	5,6	33,95	Ph-1	54	33,1	29,2	S13-2
18	27,5	33,95	Ph-1	55	38	29,2	S13-3
19	30,3	33,95	Ph-1	56	43,6	29,2	S13-3
20	33,1	33,95	Ph-1	57	65,5	29,2	S13-4
21	38	33,95	Ph-2	58	71,1	29,2	S13-4
22	40,8	33,95	Ph-2	59	12,15	20,7	G14-1
23	43,6	33,95	Ph-2	60	20,95	20,7	G14-2
24	65,5	33,95	Ph-2	61	50,15	20,7	G14-3
25	68,3	33,95	Ph-2	62	58,95	20,7	G14-4
26	71,1	33,95	Ph-2	63	9,35	20,7	S14-1
27	2,8	15,75	G11-1	64	14,95	20,7	S14-1
28	30,3	15,75	G11-2	65	18,15	20,7	S14-2
29	40,8	15,75	G11-3	66	23,75	20,7	S14-2
30	68,3	15,75	G11-4	67	47,35	20,7	S14-3
31	0	15,75	S11-1	68	52,95	20,7	S14-3
32	5,6	15,75	S11-1	69	56,15	20,7	S14-4
33	27,5	15,75	S11-2	70	61,75	20,7	S14-4
34	33,1	15,75	S11-2	71	13,3	33,95	Therm1
35	38	15,75	S11-3	72	19,8	33,95	Therm2
36	43,6	15,75	S11-3				

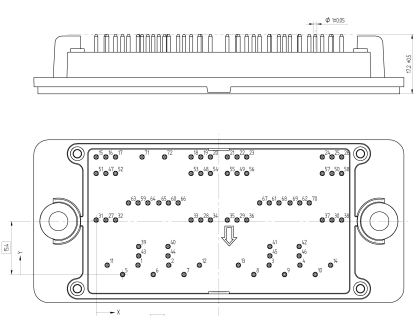

Tolerance of coordinates: <math>\pm 0,05</math> at the end of pins.  
Deviation of coordinates: <math>\pm 0,05</math> at the end of pins.

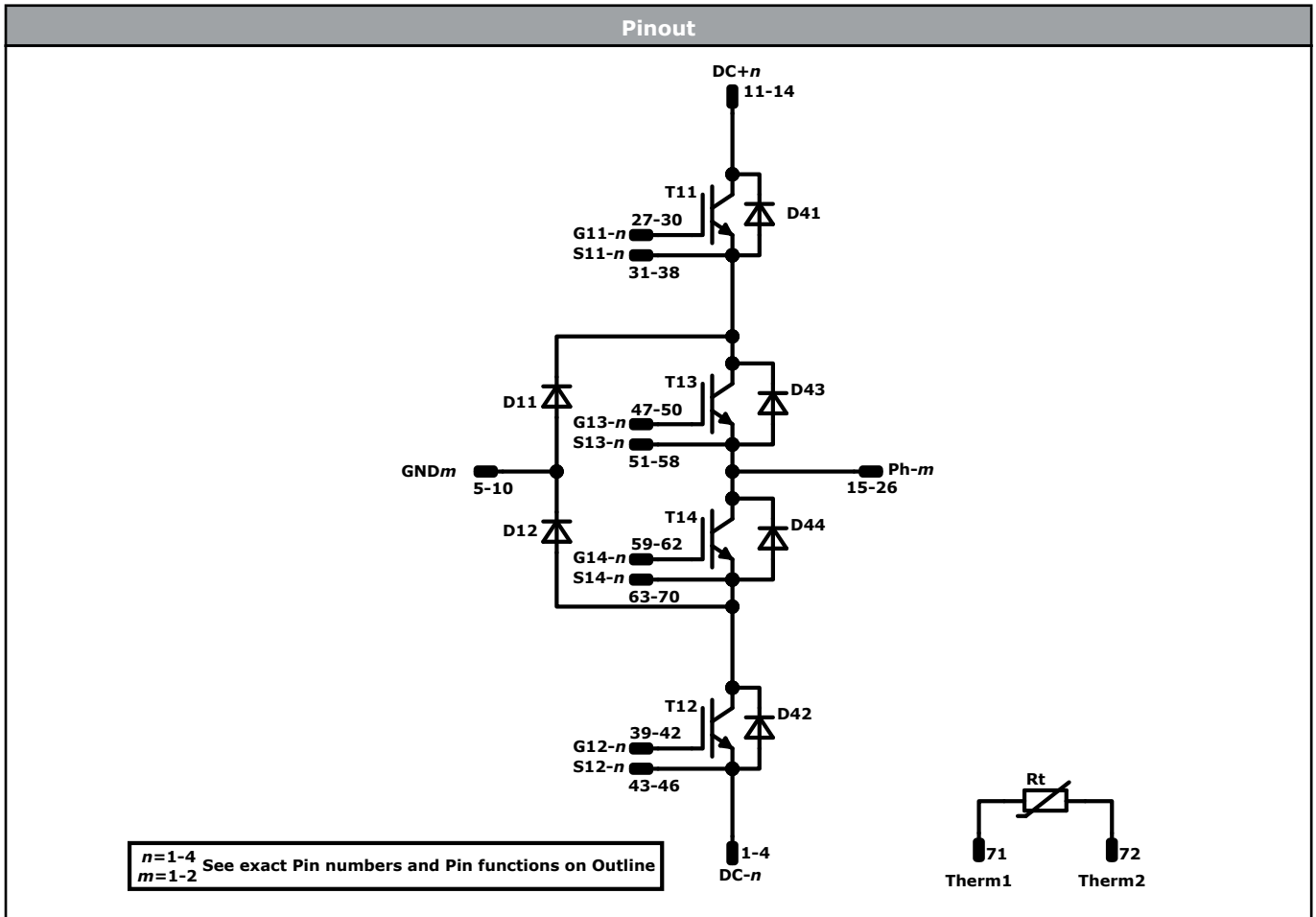

Identification					
ID	Component	Voltage	Current	Function	Comment
T11, T12	IGBT	650 V	320 A	Buck Switch	Parallel devices with separate control. Values apply to complete device.
D11, D12	FWD	650 V	300 A	Buck Diode	
T13, T14	IGBT	650 V	320 A	Boost Switch	Parallel devices with separate control. Values apply to complete device.
D42, D41	FWD	650 V	240 A	Boost Diode	
D44, D43	FWD	650 V	240 A	Boost Sw. Inv. Diode	
Rt	Thermistor			Thermistor	





Vincotech

Packaging instruction				
Standard packaging quantity (SPQ) 36	>SPQ	Standard	<SPQ	Sample

Handling instruction
Handling instructions for <i>flow 2</i> packages see vincotech.com website.

Package data
Package data for <i>flow 2</i> packages see vincotech.com website.

Vincotech thermistor reference
See Vincotech thermistor reference table at vincotech.com website.

UL recognition and file number
This device is certified according to UL 1557 standard, UL file number E192116. For more information see vincotech.com website. 

Document No.:	Date:	Modification:	Pages
30-FT07NIC320S501-PJ76F58-D1-14	24 Nov. 2023	Initial Release	

**DISCLAIMER**

The information, specifications, procedures, methods and recommendations herein (together "information") are presented by Vincotech to reader in good faith, are believed to be accurate and reliable, but may well be incomplete and/or not applicable to all conditions or situations that may exist or occur. Vincotech reserves the right to make any changes without further notice to any products to improve reliability, function or design. No representation, guarantee or warranty is made to reader as to the accuracy, reliability or completeness of said information or that the application or use of any of the same will avoid hazards, accidents, losses, damages or injury of any kind to persons or property or that the same will not infringe third parties rights or give desired results. It is reader's sole responsibility to test and determine the suitability of the information and the product for reader's intended use.

**LIFE SUPPORT POLICY**

Vincotech products are not authorised for use as critical components in life support devices or systems without the express written approval of Vincotech.

As used herein:

1. Life support devices or systems are devices or systems which, (a) are intended for surgical implant into the body, or (b) support or sustain life, or (c) whose failure to perform when properly used in accordance with instructions for use provided in labelling can be reasonably expected to result in significant injury to the user.
2. A critical component is any component of a life support device or system whose failure to perform can be reasonably expected to cause the failure of the life support device or system, or to affect its safety or effectiveness.

单击下面可查看定价，库存，交付和生命周期等信息

[>>Vincotech\(威科\)](#)