



flowPIM E2

1200 V / 25 A

**Features**

- Trench IGBT4 technology
- Standard industrial housing
- Optimized Rth(j-s) with Phase Change Material
- Built-in NTC

**Target applications**

- Industrial Drives

**Types**

- 10-EY12PMA025SC-L187A48T

**flow E2 12 mm housing**

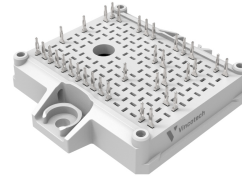

**Schematic**

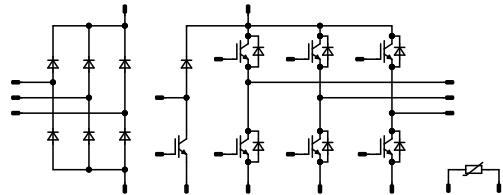



Vincotech

**10-EY12PMA025SC-L187A48T**  
datasheet

## Maximum Ratings

$T_j = 25\text{ °C}$ , unless otherwise specified

Parameter	Symbol	Conditions	Value	Unit
<b>Inverter Switch</b>				
Collector-emitter voltage	$V_{CES}$		1200	V
Collector current (DC current)	$I_C$	$T_j = T_{jmax}$ $T_s = 80\text{ °C}$	32	A
Repetitive peak collector current	$I_{CRM}$	$t_p$ limited by $T_{jmax}$	75	A
Total power dissipation	$P_{tot}$	$T_j = T_{jmax}$ $T_s = 80\text{ °C}$	86	W
Gate-emitter voltage	$V_{GES}$		$\pm 20$	V
Short circuit ratings	$t_{SC}$	$V_{GE} = 15\text{ V}$ , $V_{CC} = 800\text{ V}$ $T_j = 150\text{ °C}$	10	$\mu\text{s}$
Maximum junction temperature	$T_{jmax}$		175	$^{\circ}\text{C}$

<b>Inverter Diode</b>				
Peak repetitive reverse voltage	$V_{RRM}$		1200	V
Forward current (DC current)	$I_F$	$T_j = T_{jmax}$ $T_s = 80\text{ °C}$	31	A
Repetitive peak forward current	$I_{FRM}$	$t_p$ limited by $T_{jmax}$	50	A
Total power dissipation	$P_{tot}$	$T_j = T_{jmax}$ $T_s = 80\text{ °C}$	66	W
Maximum junction temperature	$T_{jmax}$		175	$^{\circ}\text{C}$

<b>Brake Switch</b>				
Collector-emitter voltage	$V_{CES}$		1200	V
Collector current (DC current)	$I_C$	$T_j = T_{jmax}$ $T_s = 80\text{ °C}$	32	A
Repetitive peak collector current	$I_{CRM}$	$t_p$ limited by $T_{jmax}$	75	A
Total power dissipation	$P_{tot}$	$T_j = T_{jmax}$ $T_s = 80\text{ °C}$	86	W
Gate-emitter voltage	$V_{GES}$		$\pm 20$	V
Short circuit ratings	$t_{SC}$	$V_{GE} = 15\text{ V}$ , $V_{CC} = 800\text{ V}$ $T_j = 150\text{ °C}$	10	$\mu\text{s}$
Maximum junction temperature	$T_{jmax}$		175	$^{\circ}\text{C}$



Vincotech

## Maximum Ratings

$T_j = 25\text{ °C}$ , unless otherwise specified

Parameter	Symbol	Conditions	Value	Unit
<b>Brake Diode</b>				
Peak repetitive reverse voltage	$V_{RRM}$		1200	V
Forward current (DC current)	$I_F$	$T_j = T_{jmax}$ $T_s = 80\text{ °C}$	20	A
Repetitive peak forward current	$I_{FRM}$	$t_p$ limited by $T_{jmax}$	20	A
Total power dissipation	$P_{tot}$	$T_j = T_{jmax}$ $T_s = 80\text{ °C}$	50	W
Maximum junction temperature	$T_{jmax}$		175	°C

## Rectifier Diode

Peak repetitive reverse voltage	$V_{RRM}$		1600	V
Forward current (DC current)	$I_F$	$T_j = T_{jmax}$ $T_s = 80\text{ °C}$	58	A
Surge (non-repetitive) forward current	$I_{FSM}$	Single Half Sine Wave, $t_p = 10\text{ ms}$ $T_j = 150\text{ °C}$	400	A
Surge current capability	$I^2t$		800	A <sup>2</sup> s
Total power dissipation	$P_{tot}$	$T_j = T_{jmax}$ $T_s = 80\text{ °C}$	68	W
Maximum junction temperature	$T_{jmax}$		150	°C

## Module Properties

### Thermal Properties

Storage temperature	$T_{stg}$		-40...+125	°C
Operation temperature under switching condition	$T_{jop}$		-40...+( $T_{jmax} - 25$ )	°C

### Isolation Properties

Isolation voltage	$V_{isol}$	DC Test Voltage* $t_p = 2\text{ s}$	6000	V
Isolation voltage	$V_{isol}$	AC Voltage $t_p = 1\text{ min}$	2500	V
Creepage distance			>12,7	mm
Clearance			8,83	mm
Comparative Tracking Index	CTI		≥ 600	

\*100 % tested in production



Vincotech

### Characteristic Values

Parameter	Symbol	Conditions					Values			Unit
		$V_{GE}$ [V] $V_{GS}$ [V]	$V_{CE}$ [V] $V_{DS}$ [V] $V_F$ [V]	$I_C$ [A] $I_D$ [A] $I_F$ [A]	$T_j$ [°C]	Min	Typ	Max		

#### Inverter Switch

##### Static

Gate-emitter threshold voltage	$V_{GE(th)}$	$V_{CE} = V_{GE}$			0,00085	25	5,3	5,8	6,3	V
Collector-emitter saturation voltage	$V_{CE(sat)}$		15		25	25 125 150	1,58	1,83 2,12 2,18	2,07 <sup>(1)</sup>	V
Collector-emitter cut-off current	$I_{CES}$		0	1200		25			2,4	μA
Gate-emitter leakage current	$I_{GES}$		20	0		25			120	nA
Internal gate resistance	$r_g$							None		Ω
Input capacitance	$C_{ies}$	$f = 1 \text{ Mhz}$	0	25		25		1450		pF
Reverse transfer capacitance	$C_{res}$							50		pF
Gate charge	$Q_g$		-15		0	25		200		nC

##### Thermal

Thermal resistance junction to sink <sup>(2)</sup>	$R_{th(j-s)}$	$\lambda_{paste} = 3,4 \text{ W/mK}$ (PSX)						1,11		K/W
--	---------------	---	--	--	--	--	--	------	--	-----

##### Dynamic

Turn-on delay time	$t_{d(on)}$	$R_{gon} = 16 \Omega$ $R_{goff} = 16 \Omega$	±15	600	27	25		62,6		ns
Rise time	$t_r$					125		62,4		
						150		62,8		
						25		32,4		
Turn-off delay time	$t_{d(off)}$					125		34,2		
						150		34,2		
		25		180,6						
Fall time	$t_f$	125		236						
		150		255,6						
		25		84,28						
Turn-on energy (per pulse)	$E_{on}$	$Q_{tFWD} = 2,2 \mu\text{C}$ $Q_{tFWD} = 4,12 \mu\text{C}$ $Q_{tFWD} = 4,77 \mu\text{C}$				25		1,99		mWs
						125		2,79		
						150		3,02		
Turn-off energy (per pulse)	$E_{off}$					25		1,52		
						125		2,4		
						150		2,74		



Vincotech

### Characteristic Values

Parameter	Symbol	Conditions					Values			Unit
		$V_{GE}$ [V] $V_{GS}$ [V]	$V_{CE}$ [V] $V_{DS}$ [V] $V_F$ [V]	$I_C$ [A] $I_D$ [A] $I_F$ [A]	$T_j$ [°C]	Min	Typ	Max		
<b>Inverter Diode</b>										
<b>Static</b>										
Forward voltage	$V_F$				25 125 150	1,35	1,9 1,9 1,88	2,05 <sup>(1)</sup>		V
Reverse leakage current	$I_R$	$V_r = 1200$ V				25		5,2		μA
<b>Thermal</b>										
Thermal resistance junction to sink <sup>(2)</sup>	$R_{th(j-s)}$	$\lambda_{paste} = 3,4$ W/mK (PSX)					1,44			K/W
<b>Dynamic</b>										
Peak recovery current	$I_{RRM}$					25 125 150	15,66 19,3 20,2			A
Reverse recovery time	$t_{rr}$					25 125 150	278,92 444,27 504,3			ns
Recovered charge	$Q_r$	$di/dt=707$ A/μs $di/dt=565$ A/μs $di/dt=683$ A/μs	±15	600	27	25 125 150	2,2 4,12 4,77			μC
Reverse recovered energy	$E_{rec}$					25 125 150	0,806 1,59 1,87			mWs
Peak rate of fall of recovery current	$(di_r/dt)_{max}$					25 125 150	99,04 96,55 84,72			A/μs



Vincotech

### Characteristic Values

Parameter	Symbol	Conditions					Values			Unit
		$V_{GE}$ [V] $V_{GS}$ [V]	$V_{CE}$ [V] $V_{DS}$ [V] $V_F$ [V]	$I_C$ [A] $I_D$ [A] $I_F$ [A]	$T_j$ [°C]	Min	Typ	Max		

#### Brake Switch

##### Static

Gate-emitter threshold voltage	$V_{GE(th)}$	$V_{CE} = V_{GE}$			0,00085	25	5,3	5,8	6,3	V
Collector-emitter saturation voltage	$V_{CE(sat)}$		15		25	25 125 150	1,58	1,83 2,12 2,18	2,07 <sup>(1)</sup>	V
Collector-emitter cut-off current	$I_{CES}$		0	1200		25			2,4	μA
Gate-emitter leakage current	$I_{GES}$		20	0		25			120	nA
Internal gate resistance	$r_g$							None		Ω
Input capacitance	$C_{ies}$	$f = 1 \text{ Mhz}$	0	25		25		1450		pF
Reverse transfer capacitance	$C_{res}$							50		pF
Gate charge	$Q_g$		-15		0	25		200		nC

##### Thermal

Thermal resistance junction to sink <sup>(2)</sup>	$R_{th(j-s)}$	$\lambda_{paste} = 3,4 \text{ W/mK}$ (PSX)						1,11		K/W
--	---------------	---	--	--	--	--	--	------	--	-----

##### Dynamic

Turn-on delay time	$t_{d(on)}$	$R_{gon} = 64 \Omega$ $R_{goff} = 64 \Omega$	-5/15	600	27	25		87,4		ns
Rise time	$t_r$					125		120,2	ns	
						150		118		
						25		76,8		
Turn-off delay time	$t_{d(off)}$					125		78,2	ns	
						150		77		
		25		622,2						
Fall time	$t_f$	125		483,4	ns					
		150		515						
		25		24,64						
Turn-on energy (per pulse)	$E_{on}$	125		130,87	mWs					
		150		149,46						
		25		3,87						
Turn-off energy (per pulse)	$E_{off}$	125		4,85	mWs					
		150		4,78						
		25		1,98						
						125		2,62		
						150		3		



Vincotech

10-EY12PMA025SC-L187A48T  
datasheet

### Characteristic Values

Parameter	Symbol	Conditions					Values			Unit
		$V_{GE}$ [V] $V_{GS}$ [V]	$V_{CE}$ [V] $V_{DS}$ [V] $V_F$ [V]	$I_C$ [A] $I_D$ [A] $I_F$ [A]	$T_j$ [°C]	Min	Typ	Max		
<b>Brake Diode</b>										
<b>Static</b>										
Forward voltage	$V_F$			10	25 125 150	1,35	1,79 1,77 1,73	2,05 <sup>(1)</sup>		V
Reverse leakage current	$I_R$	$V_r = 1200$ V			25			2,7		μA
<b>Thermal</b>										
Thermal resistance junction to sink <sup>(2)</sup>	$R_{th(j-s)}$	$\lambda_{paste} = 3,4$ W/mK (PSX)					1,91			K/W
<b>Dynamic</b>										
Peak recovery current	$I_{RRM}$				25 125 150		5,86 7,34 8,13			A
Reverse recovery time	$t_{rr}$				25 125 150		453,81 685,44 731,88			ns
Recovered charge	$Q_r$	$di/dt=258$ A/μs $di/dt=229$ A/μs $di/dt=235$ A/μs	-5/15	600	27	25 125 150	1,27 2,47 2,78			μC
Reverse recovered energy	$E_{rec}$				25 125 150		0,409 0,866 0,999			mWs
Peak rate of fall of recovery current	$(di_r/dt)_{max}$				25 125 150		12,62 7,34 8,63			A/μs



### Characteristic Values

Parameter	Symbol	Conditions					Values			Unit
		$V_{GE}$ [V] $V_{GS}$ [V]	$V_{CE}$ [V] $V_{DS}$ [V] $V_F$ [V]	$I_C$ [A] $I_D$ [A] $I_F$ [A]	$T_j$ [°C]	Min	Typ	Max		

#### Rectifier Diode

##### Static

Forward voltage	$V_F$				35	25 125 150		1,09 1,02 1,02	1,5 <sup>(1)</sup>	V
Reverse leakage current	$I_R$	$V_T = 1600$ V				25 150			100 2000	μA

##### Thermal

Thermal resistance junction to sink <sup>(2)</sup>	$R_{th(j-s)}$	$\lambda_{paste} = 3,4$ W/mK (PSX)						1,03		K/W
--	---------------	---------------------------------------	--	--	--	--	--	------	--	-----

#### Thermistor

##### Static

Rated resistance	$R$					25		5		kΩ
Deviation of $R_{100}$	$\Delta_{R/R}$	$R_{100} = 493$ Ω				100	-5		5	%
Power dissipation	$P$							245		mW
Power dissipation constant	$d$					25		1,4		mW/K
B-value	$B_{(25/50)}$	Tol. ±2 %						3375		K
B-value	$B_{(25/100)}$	Tol. ±2 %						3437		K
Vincotech Thermistor Reference									K	

<sup>(1)</sup> Value at chip level

<sup>(2)</sup> Only valid with pre-applied Vincotech thermal interface material.





## Inverter Switch Characteristics

figure 1. IGBT

Typical output characteristics

$$I_C = f(V_{CE})$$

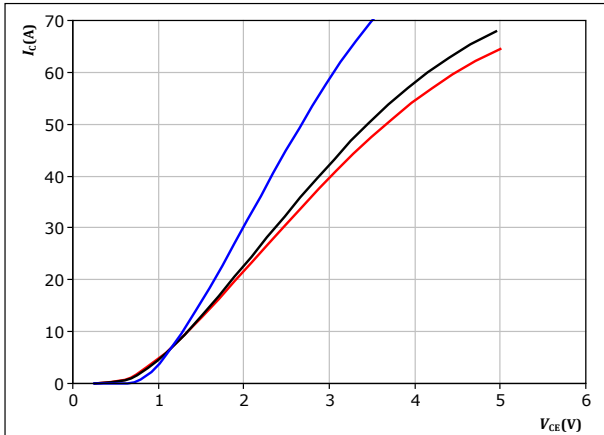

$t_p = 250 \mu s$   
 $V_{GE} = 15 V$

$T_j$ : — 25 °C  
— 125 °C  
— 150 °C

figure 2. IGBT

Typical output characteristics

$$I_C = f(V_{CE})$$

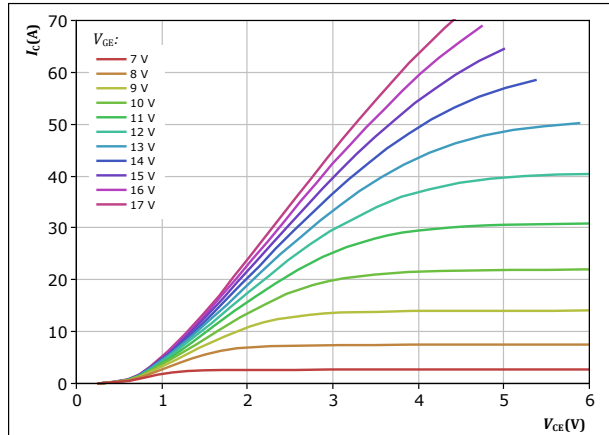

$t_p = 250 \mu s$   
 $T_j = 150 \text{ °C}$   
 $V_{GE}$  from 7 V to 17 V in steps of 1 V

figure 3. IGBT

Typical transfer characteristics

$$I_C = f(V_{GE})$$

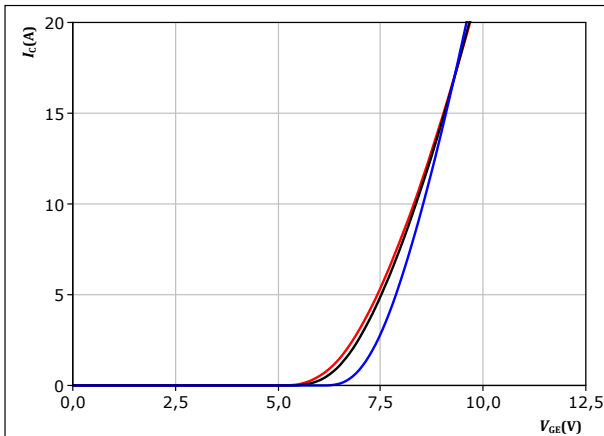

$t_p = 250 \mu s$   
 $V_{CE} = 10 V$

$T_j$ : — 25 °C  
— 125 °C  
— 150 °C

figure 4. IGBT

Transient thermal impedance as a function of pulse width

$$Z_{th(j-s)} = f(t_p)$$

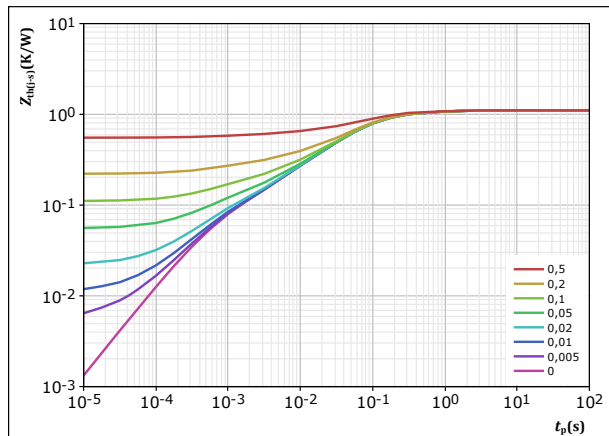

$D = t_p / T$   
 $R_{th(j-s)} = 1,106 \text{ K/W}$

IGBT thermal model values

R (K/W)	$\tau$ (s)
1,48E-01	6,22E-01
6,17E-01	8,14E-02
1,91E-01	2,57E-02
8,97E-02	5,16E-03
6,06E-02	6,02E-04



Vincotech

## Inverter Switch Characteristics

figure 5. IGBT

Safe operating area

$$I_C = f(V_{CE})$$

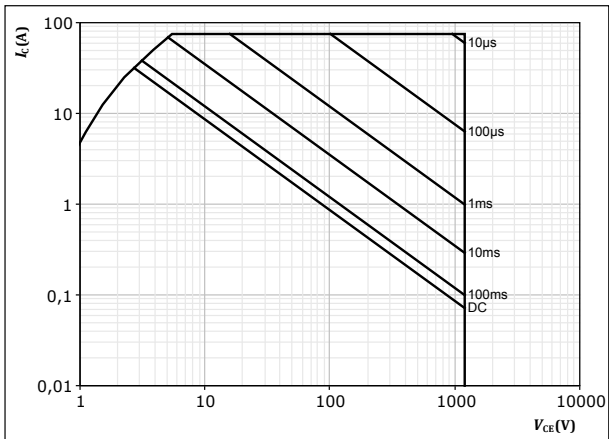

$D =$  single pulse  
 $T_s = 80$  °C  
 $V_{GE} = 15$  V  
 $T_j = T_{jmax}$



## Inverter Diode Characteristics

figure 6. FWD

Typical forward characteristics

$$I_F = f(V_F)$$

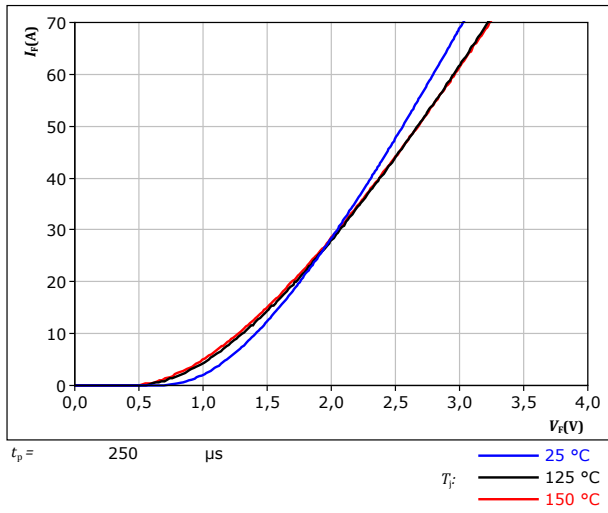
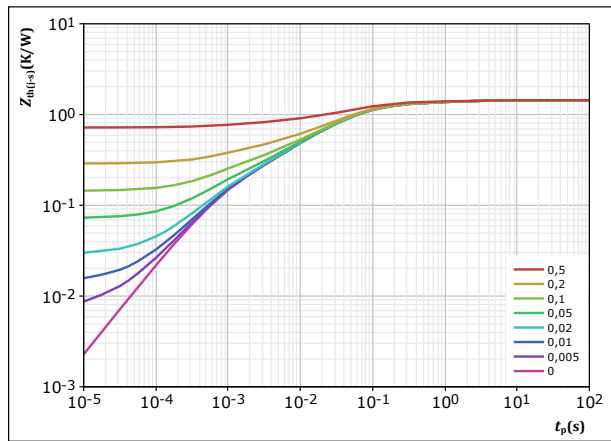

figure 7. FWD

Transient thermal impedance as a function of pulse width

$$Z_{th(j-s)} = f(t_p)$$



$D = t_p / T$   
 $R_{th(j-s)} = 1,439$  K/W  
 FWD thermal model values

R (K/W)	$\tau$ (s)
9,20E-02	2,28E+00
1,26E-01	3,18E-01
5,59E-01	6,71E-02
3,61E-01	2,27E-02
1,79E-01	5,09E-03
1,23E-01	7,30E-04



### Brake Switch Characteristics

**figure 8.** IGBT

Typical output characteristics

$$I_C = f(V_{CE})$$

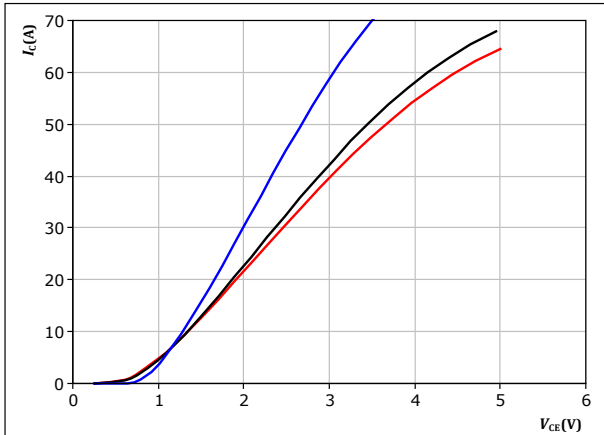

$t_p = 250 \mu s$   
 $V_{GE} = 15 V$   
 $T_j:$  25 °C, 125 °C, 150 °C

**figure 9.** IGBT

Typical output characteristics

$$I_C = f(V_{CE})$$

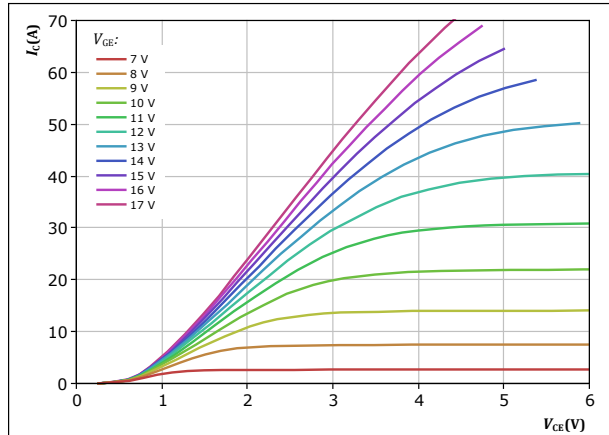

$t_p = 250 \mu s$   
 $T_j = 150 \text{ °C}$   
 $V_{GE}$  from 7 V to 17 V in steps of 1 V

**figure 10.** IGBT

Typical transfer characteristics

$$I_C = f(V_{GE})$$

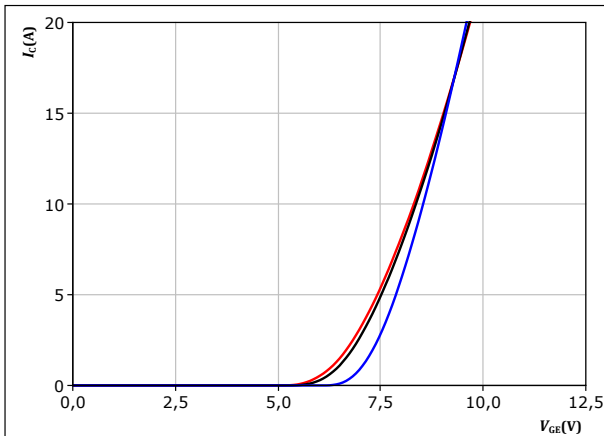

$t_p = 250 \mu s$   
 $V_{CE} = 10 V$   
 $T_j:$  25 °C, 125 °C, 150 °C

**figure 11.** IGBT

Transient thermal impedance as a function of pulse width

$$Z_{th(j-s)} = f(t_p)$$

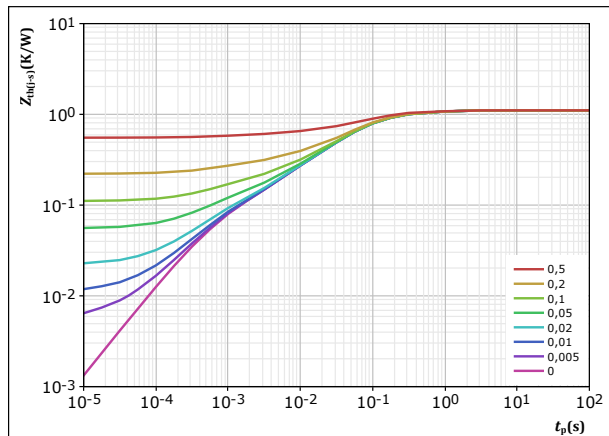

$D = t_p / T$   
 $R_{th(j-s)} = 1,106 \text{ K/W}$   
IGBT thermal model values  

R (K/W)	$\tau$ (s)
1,48E-01	6,22E-01
6,17E-01	8,14E-02
1,91E-01	2,57E-02
8,97E-02	5,16E-03
6,06E-02	6,02E-04



### Brake Switch Characteristics

figure 12. IGBT

Safe operating area

$$I_C = f(V_{CE})$$

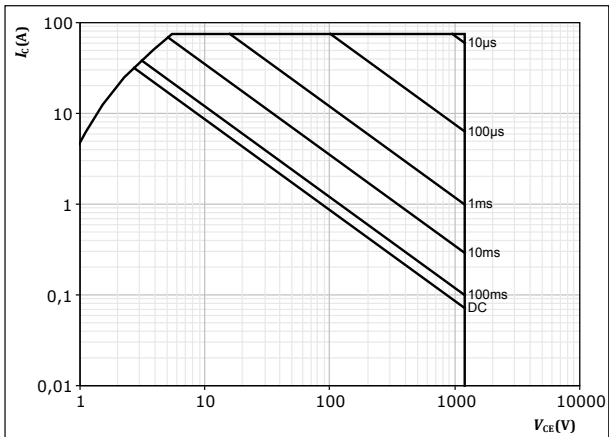

$D =$  single pulse  
 $T_s = 80 \text{ } ^\circ\text{C}$   
 $V_{CE} = 15 \text{ V}$   
 $T_j = T_{jmax}$



### Brake Diode Characteristics

figure 13. FWD

Typical forward characteristics

$$I_F = f(V_F)$$

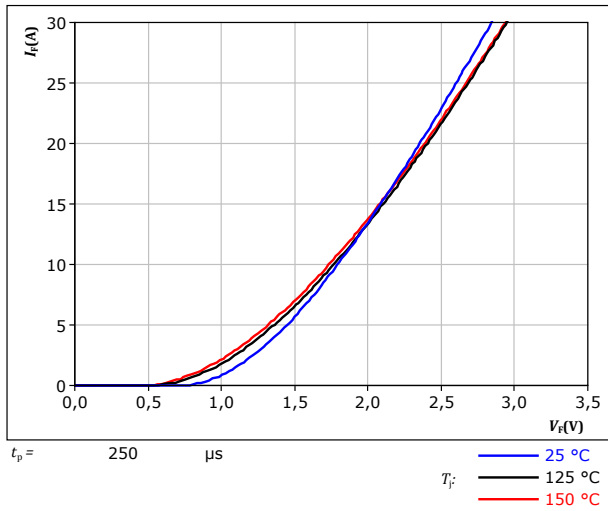
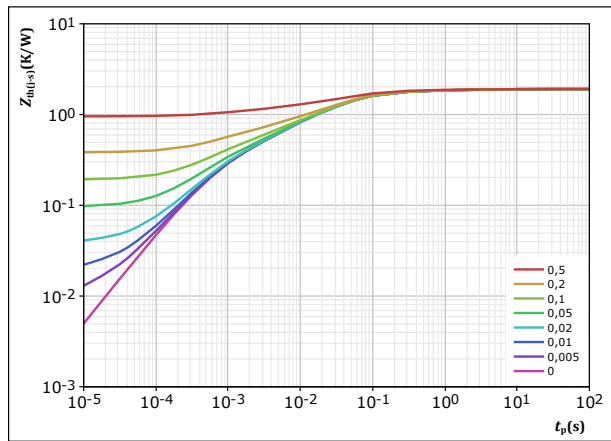

figure 14. FWD

Transient thermal impedance as a function of pulse width

$$Z_{th(j-s)} = f(t_p)$$



$D = t_p / T$   
 $R_{th(j-s)} = 1,909$  K/W  
 FWD thermal model values

R (K/W)	$\tau$ (s)
6,90E-02	3,61E+00
1,74E-01	3,07E-01
8,07E-01	4,87E-02
3,70E-01	1,36E-02
2,79E-01	3,22E-03
2,10E-01	5,68E-04



## Rectifier Diode Characteristics

figure 15. Rectifier

Typical forward characteristics

$$I_F = f(V_F)$$

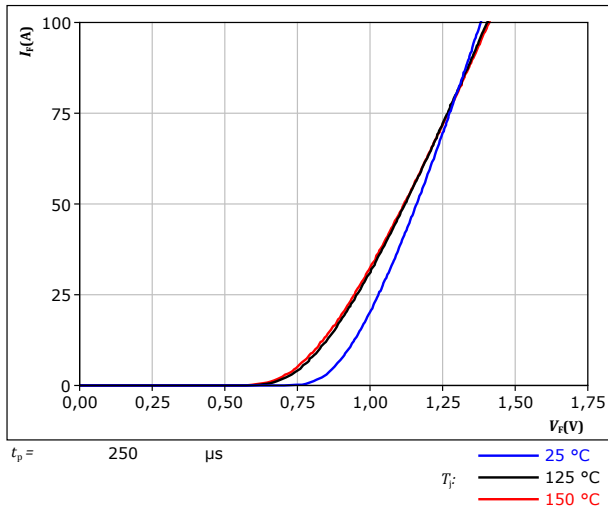
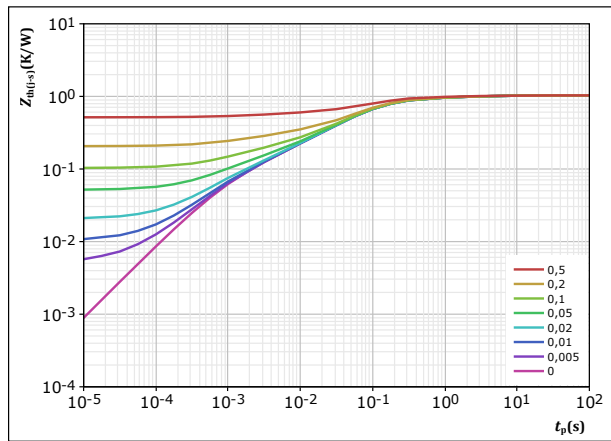

figure 16. Rectifier

Transient thermal impedance as a function of pulse width

$$Z_{th(j-s)} = f(t_p)$$



$D = t_p / T$   
 $R_{th(j-s)} = 1,032 \text{ K/W}$   
 Rectifier thermal model values

$R$ (K/W)	$\tau$ (s)
4,86E-02	5,67E+00
1,31E-01	6,68E-01
5,24E-01	9,95E-02
1,97E-01	3,35E-02
8,14E-02	4,54E-03
4,98E-02	8,29E-04



### Thermistor Characteristics

figure 17. Thermistor

Typical NTC characteristic as function of temperature  
 $R_T = f(T)$

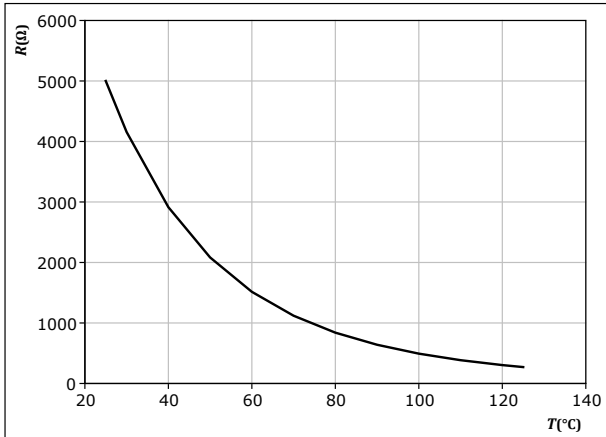





## Inverter Switching Characteristics

**figure 18.** IGBT

Typical switching energy losses as a function of collector current  
 $E = f(I_c)$

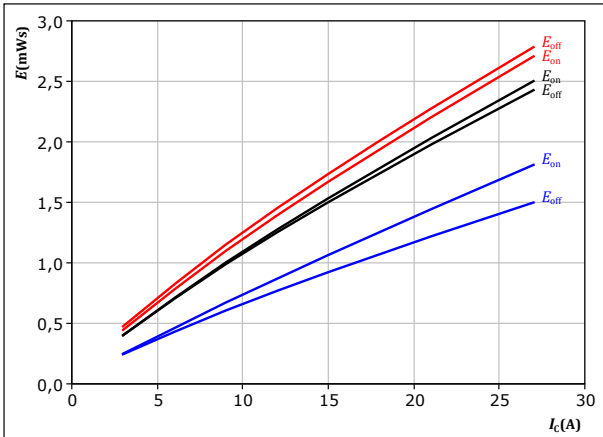

With an inductive load at  
 $V_{CE} = 600 \text{ V}$   
 $V_{GE} = \pm 15 \text{ V}$   
 $R_{gon} = 16 \ \Omega$   
 $R_{goff} = 16 \ \Omega$

$T_f$ : 25 °C (blue), 125 °C (black), 150 °C (red)

**figure 19.** IGBT

Typical switching energy losses as a function of gate resistor  
 $E = f(R_g)$

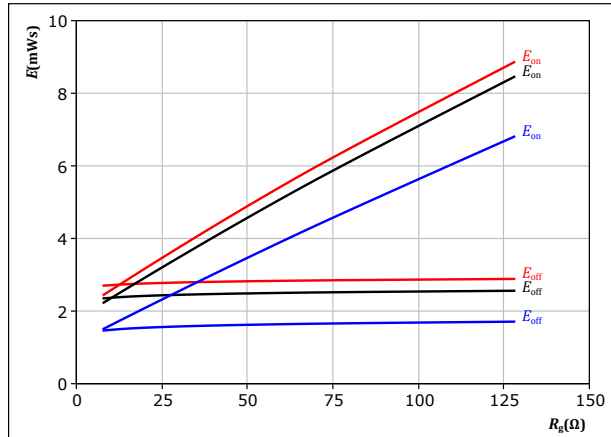

With an inductive load at  
 $V_{CE} = 600 \text{ V}$   
 $V_{GE} = \pm 15 \text{ V}$   
 $I_c = 27 \text{ A}$

$T_f$ : 25 °C (blue), 125 °C (black), 150 °C (red)

**figure 20.** FWD

Typical reverse recovered energy loss as a function of collector current  
 $E_{rec} = f(I_c)$

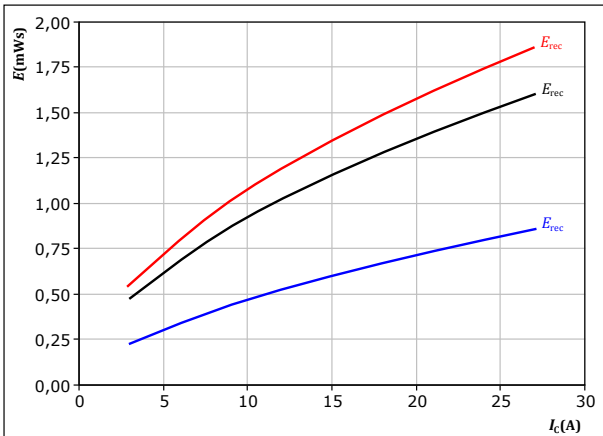

With an inductive load at  
 $V_{CE} = 600 \text{ V}$   
 $V_{GE} = \pm 15 \text{ V}$   
 $R_{gon} = 16 \ \Omega$

$T_f$ : 25 °C (blue), 125 °C (black), 150 °C (red)

**figure 21.** FWD

Typical reverse recovered energy loss as a function of gate resistor  
 $E_{rec} = f(R_g)$

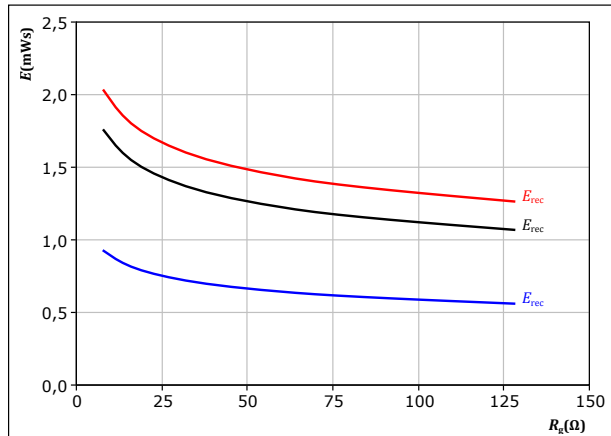

With an inductive load at  
 $V_{CE} = 600 \text{ V}$   
 $V_{GE} = \pm 15 \text{ V}$   
 $I_c = 27 \text{ A}$

$T_f$ : 25 °C (blue), 125 °C (black), 150 °C (red)



## Inverter Switching Characteristics

**figure 22.** IGBT

Typical switching times as a function of collector current  
 $t = f(I_c)$

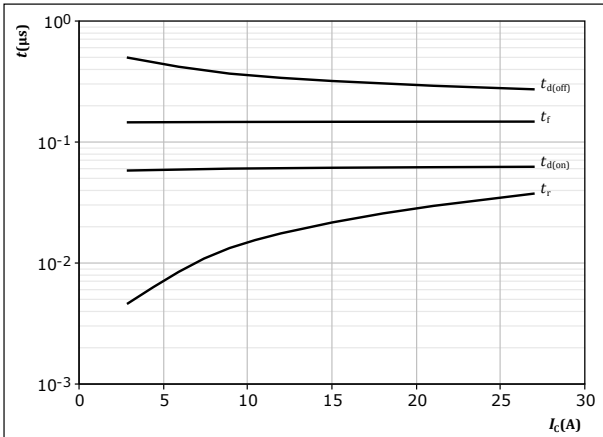

With an inductive load at  
 $T_j = 150 \text{ }^\circ\text{C}$   
 $V_{CE} = 600 \text{ V}$   
 $V_{GE} = \pm 15 \text{ V}$   
 $R_{g(on)} = 16 \text{ } \Omega$   
 $R_{g(off)} = 16 \text{ } \Omega$

**figure 23.** IGBT

Typical switching times as a function of gate resistor  
 $t = f(R_g)$

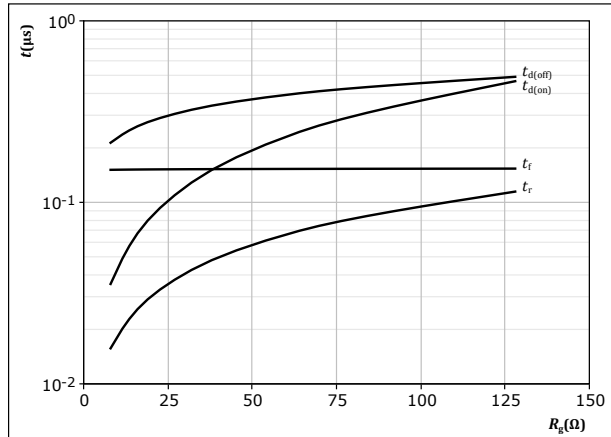

With an inductive load at  
 $T_j = 150 \text{ }^\circ\text{C}$   
 $V_{CE} = 600 \text{ V}$   
 $V_{GE} = \pm 15 \text{ V}$   
 $I_c = 27 \text{ A}$

**figure 24.** FWD

Typical reverse recovery time as a function of collector current  
 $t_{rr} = f(I_c)$

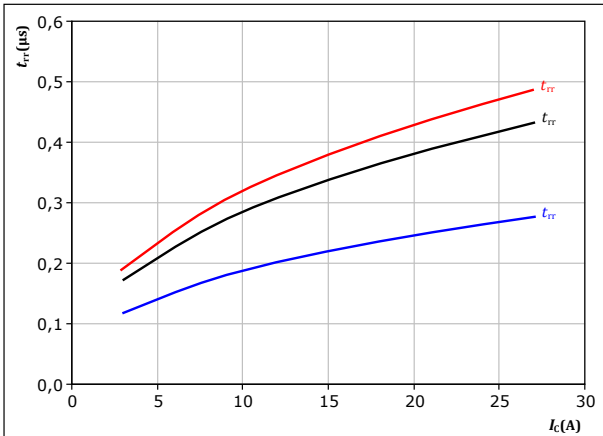

With an inductive load at  
 $V_{CE} = 600 \text{ V}$   
 $V_{GE} = \pm 15 \text{ V}$   
 $R_{g(on)} = 16 \text{ } \Omega$   
 $T_j: \text{ — } 25 \text{ }^\circ\text{C}$   
 $\text{ — } 125 \text{ }^\circ\text{C}$   
 $\text{ — } 150 \text{ }^\circ\text{C}$

**figure 25.** FWD

Typical reverse recovery time as a function of IGBT turn off gate resistor  
 $t_{rr} = f(R_{g(off)})$

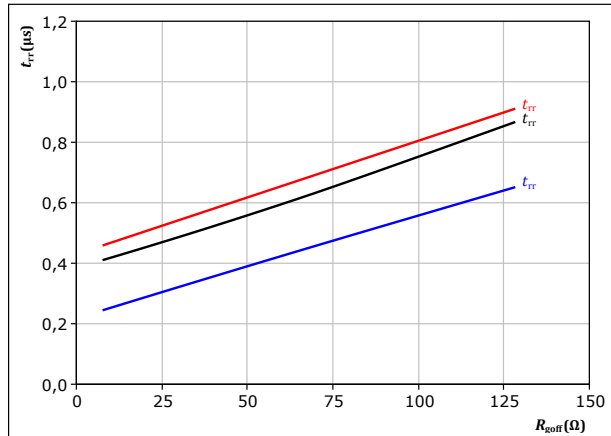

With an inductive load at  
 $V_{CE} = 600 \text{ V}$   
 $V_{GE} = \pm 15 \text{ V}$   
 $I_c = 27 \text{ A}$   
 $T_j: \text{ — } 25 \text{ }^\circ\text{C}$   
 $\text{ — } 125 \text{ }^\circ\text{C}$   
 $\text{ — } 150 \text{ }^\circ\text{C}$



## Inverter Switching Characteristics

figure 26. FWD

Typical recovered charge as a function of collector current

$$Q_r = f(I_c)$$

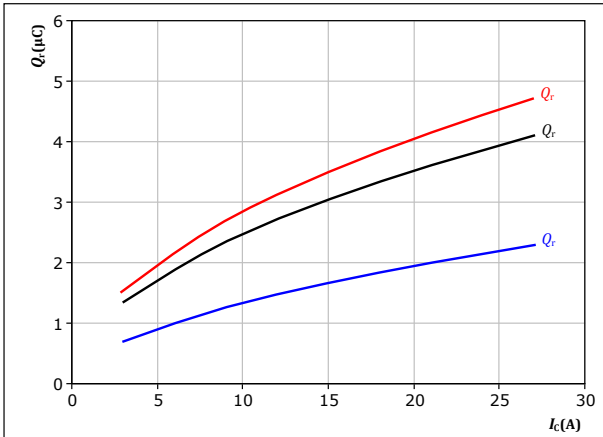

With an inductive load at

$V_{CE} = 600 \text{ V}$   
 $V_{GE} = \pm 15 \text{ V}$   
 $R_{goff} = 16 \text{ } \Omega$

$T_j$ :  $25 \text{ } ^\circ\text{C}$  (blue)  
 $125 \text{ } ^\circ\text{C}$  (black)  
 $150 \text{ } ^\circ\text{C}$  (red)

figure 27. FWD

Typical recovered charge as a function of turn off gate resistor

$$Q_r = f(R_{goff})$$

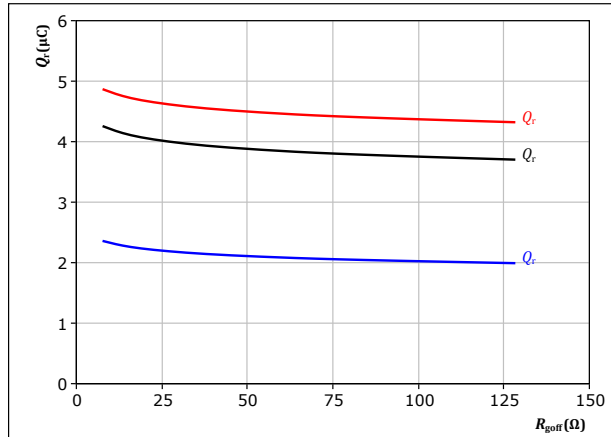

With an inductive load at

$V_{CE} = 600 \text{ V}$   
 $V_{GE} = \pm 15 \text{ V}$   
 $I_c = 27 \text{ A}$

$T_j$ :  $25 \text{ } ^\circ\text{C}$  (blue)  
 $125 \text{ } ^\circ\text{C}$  (black)  
 $150 \text{ } ^\circ\text{C}$  (red)

figure 28. FWD

Typical peak reverse recovery current as a function of collector current

$$I_{RM} = f(I_c)$$

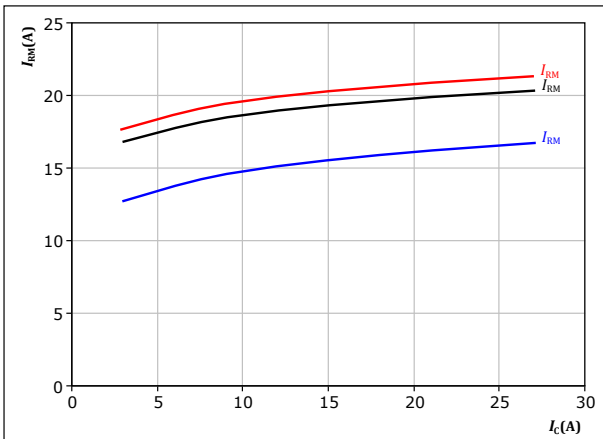

With an inductive load at

$V_{CE} = 600 \text{ V}$   
 $V_{GE} = \pm 15 \text{ V}$   
 $R_{goff} = 16 \text{ } \Omega$

$T_j$ :  $25 \text{ } ^\circ\text{C}$  (blue)  
 $125 \text{ } ^\circ\text{C}$  (black)  
 $150 \text{ } ^\circ\text{C}$  (red)

figure 29. FWD

Typical peak reverse recovery current as a function of turn off gate resistor

$$I_{RM} = f(R_{goff})$$

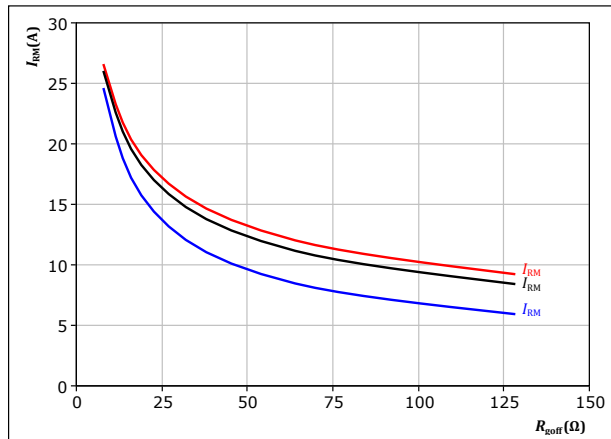

With an inductive load at

$V_{CE} = 600 \text{ V}$   
 $V_{GE} = \pm 15 \text{ V}$   
 $I_c = 27 \text{ A}$

$T_j$ :  $25 \text{ } ^\circ\text{C}$  (blue)  
 $125 \text{ } ^\circ\text{C}$  (black)  
 $150 \text{ } ^\circ\text{C}$  (red)



## Inverter Switching Characteristics

**figure 30.** FWD

Typical rate of fall of forward and reverse recovery current as a function of collector current  
 $di_f/dt, di_{rr}/dt = f(I_c)$

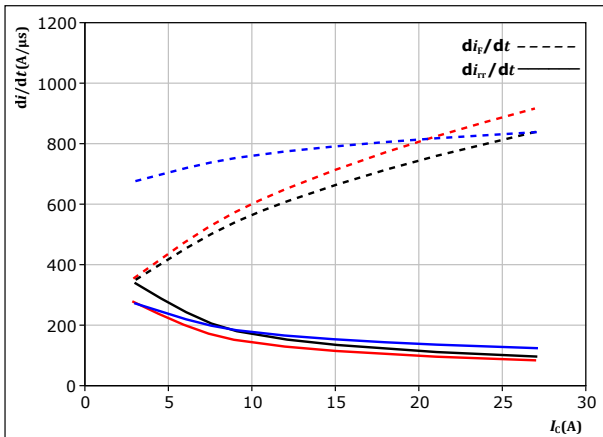

With an inductive load at

$V_{CE} = 600$ V	$T_j = 25$ °C
$V_{GE} = \pm 15$ V	$T_j = 125$ °C
$R_{goff} = 16$ Ω	$T_j = 150$ °C

**figure 31.** FWD

Typical rate of fall of forward and reverse recovery current as a function of turn off gate resistor  
 $di_f/dt, di_{rr}/dt = f(R_{goff})$

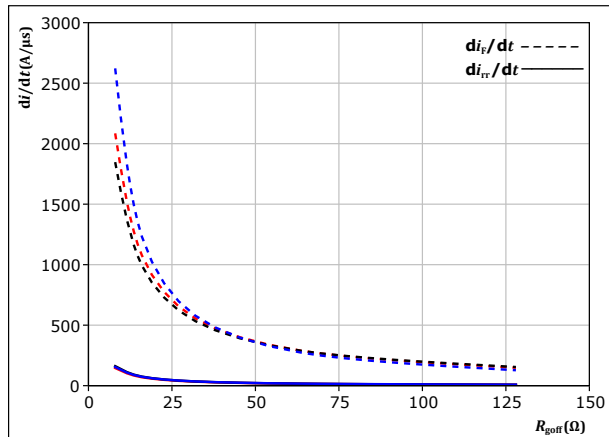

With an inductive load at

$V_{CE} = 600$ V	$T_j = 25$ °C
$V_{GE} = \pm 15$ V	$T_j = 125$ °C
$I_c = 27$ A	$T_j = 150$ °C

**figure 32.** IGBT

Reverse bias safe operating area  
 $I_c = f(V_{CE})$

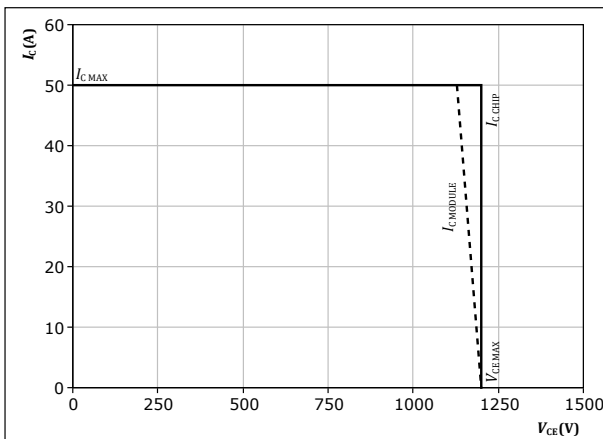

At  $T_j = 150$  °C  
 $R_{goff} = 16$  Ω  
 $R_{goff} = 16$  Ω



## Brake Switching Characteristics

figure 33. IGBT

Typical switching energy losses as a function of collector current  
 $E = f(I_c)$

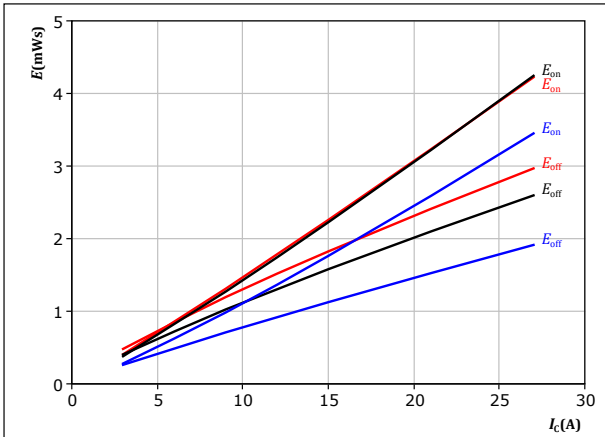

With an inductive load at  
 $V_{CE} = 600$  V  
 $V_{GE} = -5/15$  V  
 $R_{gon} = 64$   $\Omega$   
 $R_{goff} = 64$   $\Omega$

$T_j$ : — 25 °C  
 — 125 °C  
 — 150 °C

figure 34. IGBT

Typical switching energy losses as a function of gate resistor  
 $E = f(R_g)$

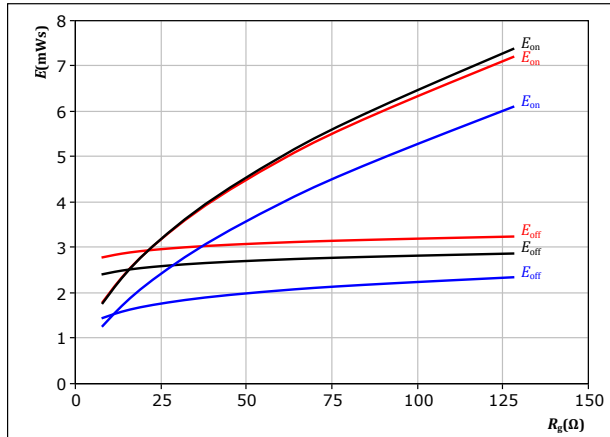

With an inductive load at  
 $V_{CE} = 600$  V  
 $V_{GE} = -5/15$  V  
 $I_c = 27$  A

$T_j$ : — 25 °C  
 — 125 °C  
 — 150 °C

figure 35. FWD

Typical reverse recovered energy loss as a function of collector current  
 $E_{rec} = f(I_c)$

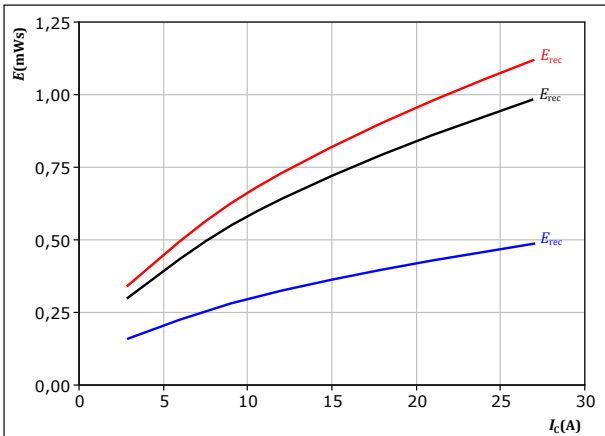

With an inductive load at  
 $V_{CE} = 600$  V  
 $V_{GE} = -5/15$  V  
 $R_{gon} = 64$   $\Omega$

$T_j$ : — 25 °C  
 — 125 °C  
 — 150 °C

figure 36. FWD

Typical reverse recovered energy loss as a function of gate resistor  
 $E_{rec} = f(R_g)$

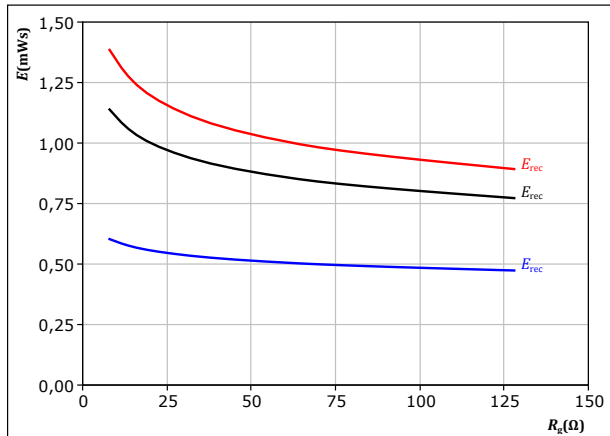

With an inductive load at  
 $V_{CE} = 600$  V  
 $V_{GE} = -5/15$  V  
 $I_c = 27$  A

$T_j$ : — 25 °C  
 — 125 °C  
 — 150 °C



## Brake Switching Characteristics

**figure 37.** IGBT

Typical switching times as a function of collector current  
 $t = f(I_c)$

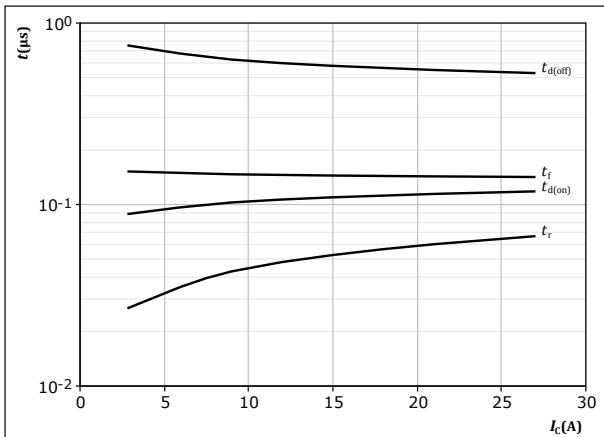

With an inductive load at  
 $T_j = 150 \text{ }^\circ\text{C}$   
 $V_{CE} = 600 \text{ V}$   
 $V_{GE} = -5/15 \text{ V}$   
 $R_{gon} = 64 \text{ } \Omega$   
 $R_{goff} = 64 \text{ } \Omega$

**figure 38.** IGBT

Typical switching times as a function of gate resistor  
 $t = f(R_g)$

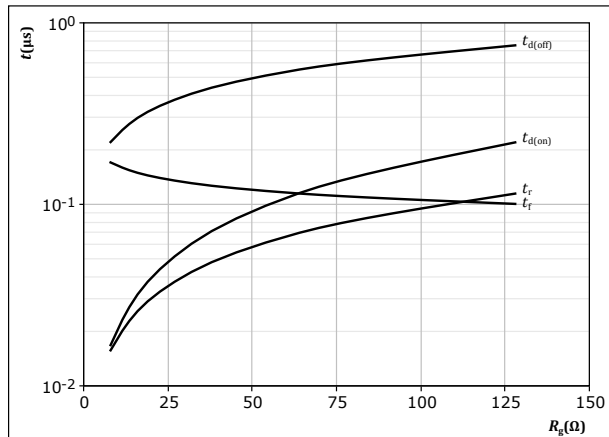

With an inductive load at  
 $T_j = 150 \text{ }^\circ\text{C}$   
 $V_{CE} = 600 \text{ V}$   
 $V_{GE} = -5/15 \text{ V}$   
 $I_c = 27 \text{ A}$

**figure 39.** FWD

Typical reverse recovery time as a function of collector current  
 $t_{rr} = f(I_c)$

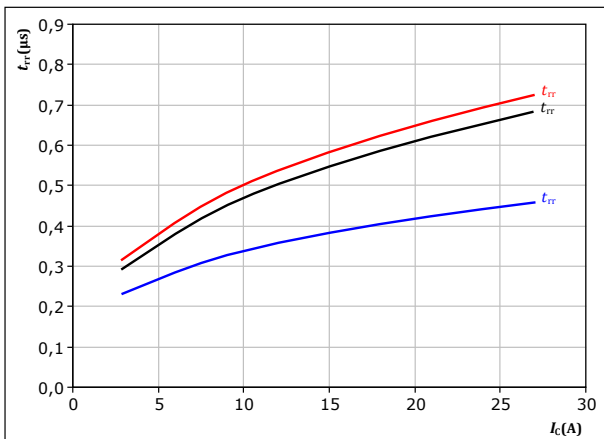

With an inductive load at  
 $V_{CE} = 600 \text{ V}$   
 $V_{GE} = -5/15 \text{ V}$   
 $R_{gon} = 64 \text{ } \Omega$   
 $T_j:$  — 25 °C  
— 125 °C  
— 150 °C

**figure 40.** FWD

Typical reverse recovery time as a function of IGBT turn off gate resistor  
 $t_{rr} = f(R_{goff})$

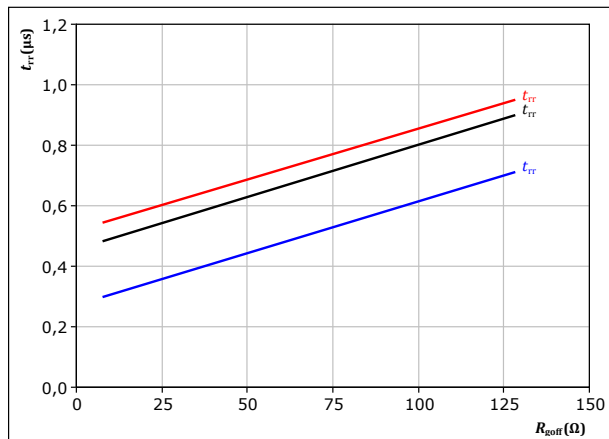

With an inductive load at  
 $V_{CE} = 600 \text{ V}$   
 $V_{GE} = -5/15 \text{ V}$   
 $I_c = 27 \text{ A}$   
 $T_j:$  — 25 °C  
— 125 °C  
— 150 °C



## Brake Switching Characteristics

figure 41. FWD

Typical recovered charge as a function of collector current

$$Q_r = f(I_c)$$

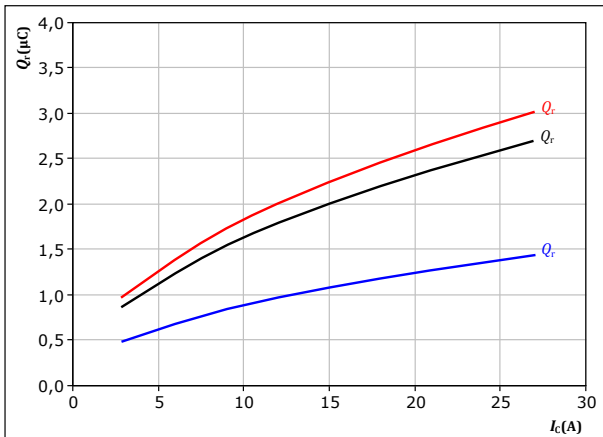

With an inductive load at

$V_{CE} = 600$  V  
 $V_{GE} = -5/15$  V  
 $R_{goff} = 64$  Ω  
 $T_j$ : 25 °C (blue), 125 °C (black), 150 °C (red)

figure 42. FWD

Typical recovered charge as a function of turn off gate resistor

$$Q_r = f(R_{goff})$$

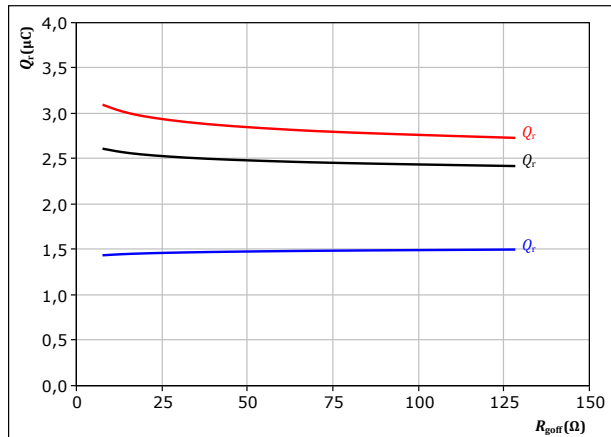

With an inductive load at

$V_{CE} = 600$  V  
 $V_{GE} = -5/15$  V  
 $I_c = 27$  A  
 $T_j$ : 25 °C (blue), 125 °C (black), 150 °C (red)

figure 43. FWD

Typical peak reverse recovery current as a function of collector current

$$I_{RM} = f(I_c)$$

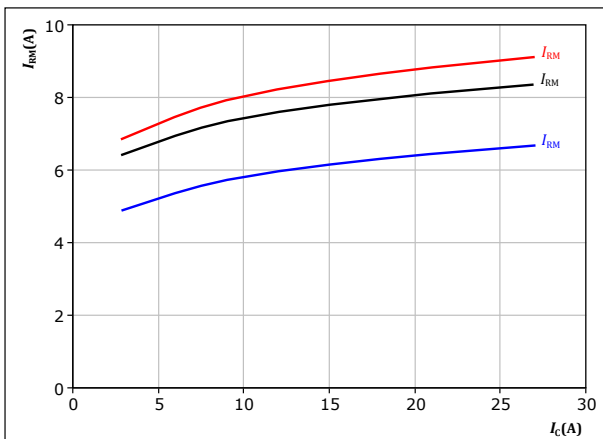

With an inductive load at

$V_{CE} = 600$  V  
 $V_{GE} = -5/15$  V  
 $R_{goff} = 64$  Ω  
 $T_j$ : 25 °C (blue), 125 °C (black), 150 °C (red)

figure 44. FWD

Typical peak reverse recovery current as a function of turn off gate resistor

$$I_{RM} = f(R_{goff})$$

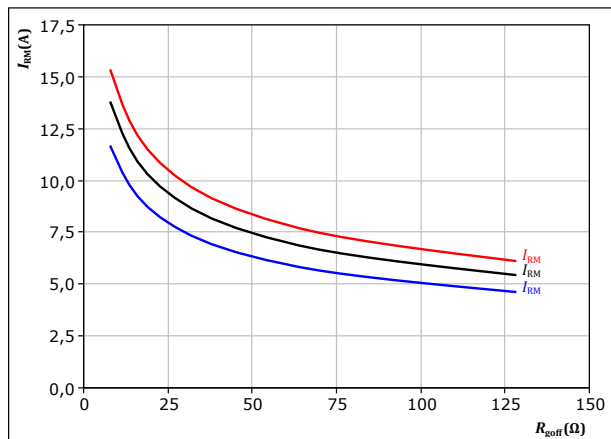

With an inductive load at

$V_{CE} = 600$  V  
 $V_{GE} = -5/15$  V  
 $I_c = 27$  A  
 $T_j$ : 25 °C (blue), 125 °C (black), 150 °C (red)



## Brake Switching Characteristics

**figure 45.** FWD

Typical rate of fall of forward and reverse recovery current as a function of collector current  
 $di_f/dt, di_r/dt = f(I_c)$

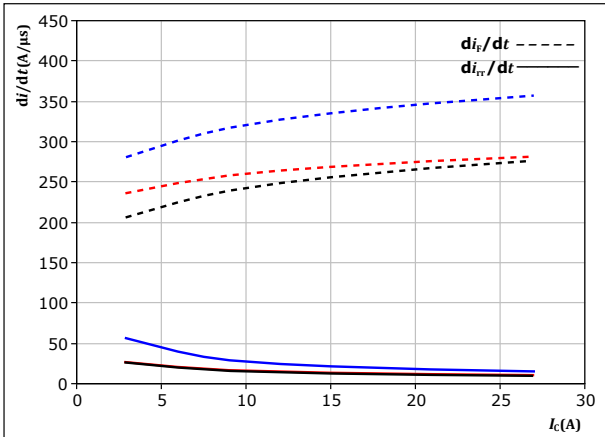

With an inductive load at

$V_{CE} = 600 \text{ V}$   
 $V_{GE} = -5/15 \text{ V}$   
 $R_{goff} = 64 \text{ } \Omega$

— 25 °C  
 — 125 °C  
 — 150 °C

**figure 46.** FWD

Typical rate of fall of forward and reverse recovery current as a function of turn off gate resistor  
 $di_f/dt, di_r/dt = f(R_{goff})$

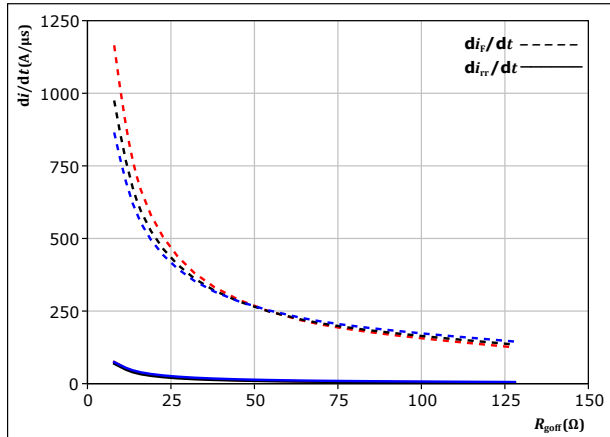

With an inductive load at

$V_{CE} = 600 \text{ V}$   
 $V_{GE} = -5/15 \text{ V}$   
 $I_c = 27 \text{ A}$

— 25 °C  
 — 125 °C  
 — 150 °C

**figure 47.** IGBT

Reverse bias safe operating area

$I_c = f(V_{CE})$

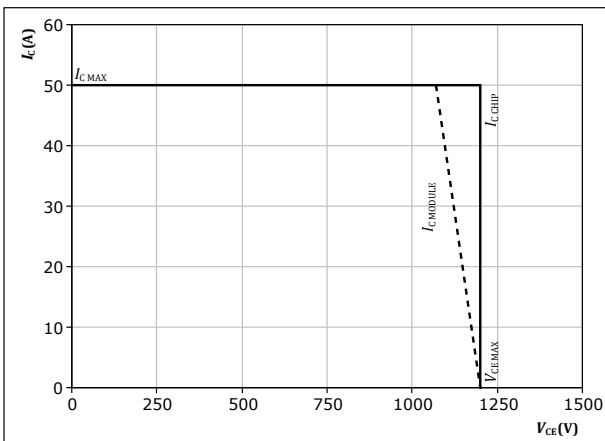

At  $T_j = 150 \text{ } ^\circ\text{C}$   
 $R_{goff} = 64 \text{ } \Omega$   
 $R_{goff} = 64 \text{ } \Omega$





### Switching Definitions

figure 48. IGBT

Turn-off Switching Waveforms & definition of  $t_{doff}$ ,  $t_{Eoff}$  ( $t_{Eoff}$  = integrating time for  $E_{off}$ )

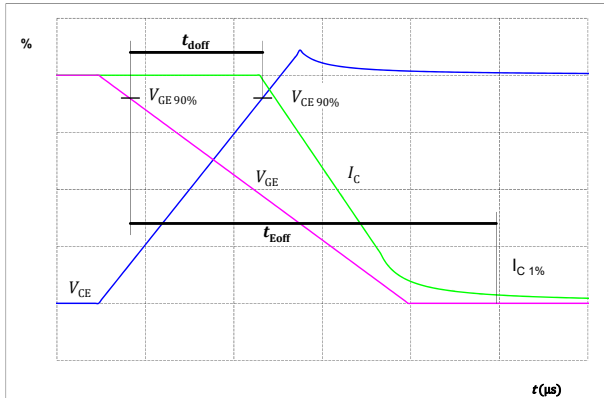

figure 49. IGBT

Turn-on Switching Waveforms & definition of  $t_{don}$ ,  $t_{Eon}$  ( $t_{Eon}$  = integrating time for  $E_{on}$ )



figure 50. IGBT

Turn-off Switching Waveforms & definition of  $t_f$

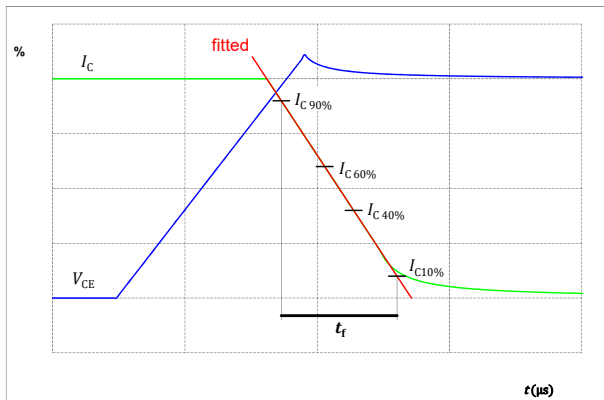
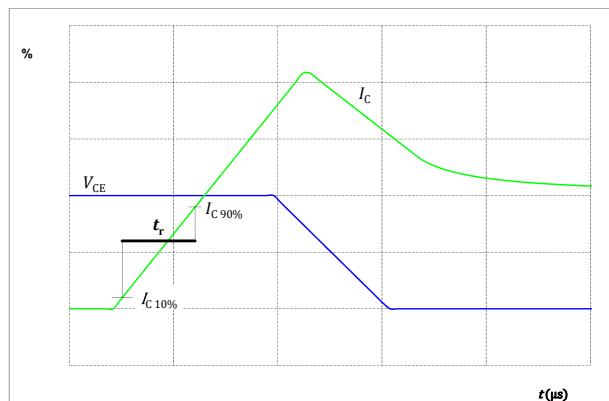

figure 51. IGBT

Turn-on Switching Waveforms & definition of  $t_r$





### Switching Definitions

figure 52. FWD

Turn-off Switching Waveforms & definition of  $t_{rr}$

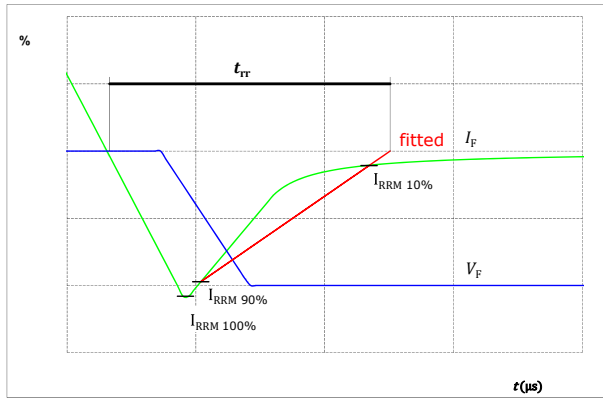
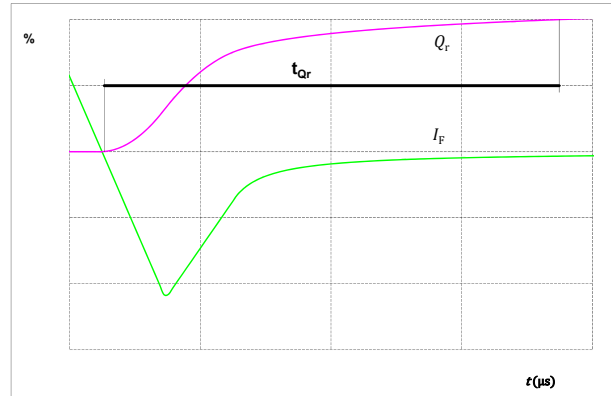

figure 53. FWD

Turn-on Switching Waveforms & definition of  $t_{Qr}$  ( $t_{Qr}$  = integrating time for  $Q_r$ )





Vincotech

**10-EY12PMA025SC-L187A48T**  
datasheet

Ordering Code	
<b>Version</b>	<b>Ordering Code</b>
Without thermal paste	10-EY12PMA025SC-L187A48T
With thermal paste	10-EY12PMA025SC-L187A48T-/3/

Marking						
	<b>Text</b>	<b>Name</b> NN-NNNNNNNNNNNNNN- TTTTTVV	<b>Date code</b> WWYY	<b>UL &amp; VIN</b> UL VIN	<b>Lot</b> LLLLL	<b>Serial</b> SSSS
	<b>Datamatrix</b>	<b>Type&amp;Ver</b> TTTTTTVV	<b>Lot number</b> LLLLL	<b>Serial</b> SSSS	<b>Date code</b> WWYY	

Outline				
Pin table [mm]				
Pin	X	Y	Function	
1	25,6	6,4	ACIn2	
2	22,4	6,4	ACIn2	
3	16	9,6	ACIn1	
4	12,8	9,6	ACIn1	
5	9,6	0	DC+Rect	
6	9,6	3,2	DC+Rect	
7	0	0	DC-Rect	
8	0	3,2	DC-Rect	
9	0	16	G27	
10	0	19,2	DC-Br	
11	0	22,4	G11	
12	0	25,6	DC-1	
13	0	28,8	DC-1	
14	0	32	G13	
15	0	35,2	DC-2	
16	0	38,4	DC-2	
17	0	41,6	G15	
18	0	44,8	DC-3	
19	0	48	DC-3	
20	9,6	48	Therm1	
21	19,2	48	Therm2	
22	28,8	48	G16	
23	32	48	Ph3	
24	32	44,8	Ph3	
25	32	35,2	G14	
26	32	32	Ph2	
27	32	28,8	Ph2	
28	32	19,2	G12	
29	32	16	Ph1	
30	32	12,8	Ph1	
31	32	3,2	ACIn3	
32	32	0	ACIn3	
33	22,4	19,2	DC+Inv	
34	22,4	16	DC+Inv	
35	9,6	19,2	Br	

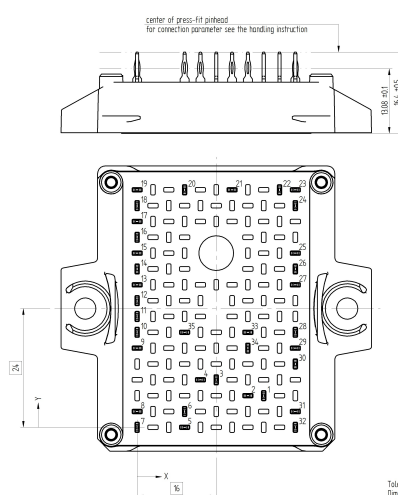

Tolerance of displacement: +0,05mm at the end of axis  
Dimension of coordinate axis is only offset without tolerance



Vincotech

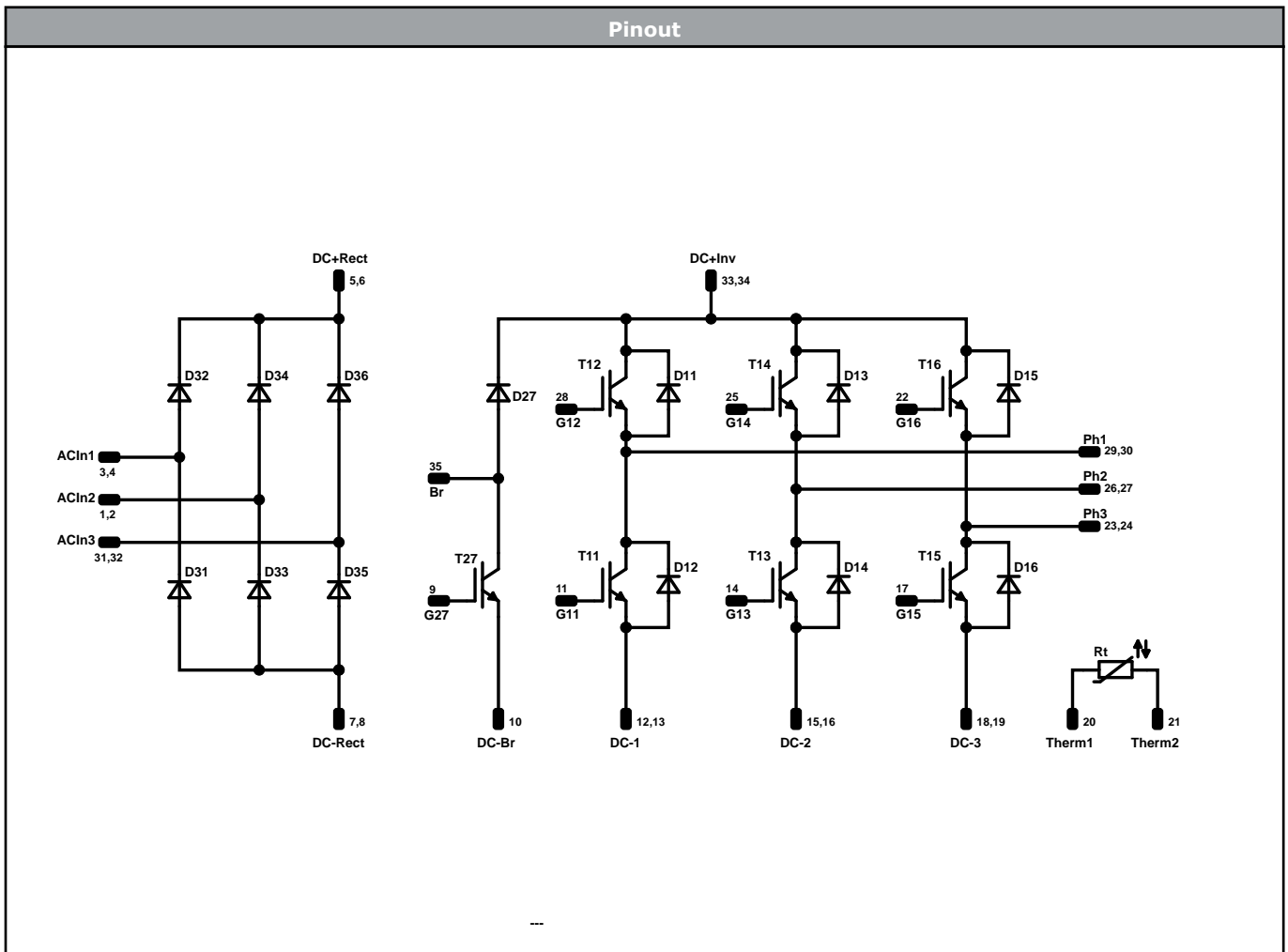

Identification					
ID	Component	Voltage	Current	Function	Comment
T11, T12, T13, T14, T15, T16	IGBT	1200 V	25 A	Inverter Switch	
D11, D12, D13, D14, D15, D16	FWD	1200 V	25 A	Inverter Diode	
T27	IGBT	1200 V	25 A	Brake Switch	
D27	FWD	1200 V	10 A	Brake Diode	
D31, D32, D33, D34, D35, D36	Rectifier	1600 V	35 A	Rectifier Diode	
Rt	NTC			Thermistor	



Packaging instruction				
Standard packaging quantity (SPQ) 100	>SPQ	Standard	<SPQ	Sample

Handling instruction
Handling instructions for <i>flow</i> E2 packages see vincotech.com website.

Package data
Package data for <i>flow</i> E2 packages see vincotech.com website.

Vincotech thermistor reference
See Vincotech thermistor reference table at vincotech.com website.

UL recognition and file number
This device is certified according to UL 1557 standard, UL file number E192116. For more information see vincotech.com website. 

Document No.:	Date:	Modification:	Pages
10-EY12PMA025SC-L187A48T-D5-14	16 Apr. 2021	Update characteristics of rectifier diode, leakage current max value from 50 -> 100 uA	

**DISCLAIMER**

The information, specifications, procedures, methods and recommendations herein (together "information") are presented by Vincotech to reader in good faith, are believed to be accurate and reliable, but may well be incomplete and/or not applicable to all conditions or situations that may exist or occur. Vincotech reserves the right to make any changes without further notice to any products to improve reliability, function or design. No representation, guarantee or warranty is made to reader as to the accuracy, reliability or completeness of said information or that the application or use of any of the same will avoid hazards, accidents, losses, damages or injury of any kind to persons or property or that the same will not infringe third parties rights or give desired results. It is reader's sole responsibility to test and determine the suitability of the information and the product for reader's intended use.

**LIFE SUPPORT POLICY**

Vincotech products are not authorised for use as critical components in life support devices or systems without the express written approval of Vincotech.

As used herein:

1. Life support devices or systems are devices or systems which, (a) are intended for surgical implant into the body, or (b) support or sustain life, or (c) whose failure to perform when properly used in accordance with instructions for use provided in labelling can be reasonably expected to result in significant injury to the user.
2. A critical component is any component of a life support device or system whose failure to perform can be reasonably expected to cause the failure of the life support device or system, or to affect its safety or effectiveness.

单击下面可查看定价，库存，交付和生命周期等信息

[>>Vincotech\(威科\)](#)