

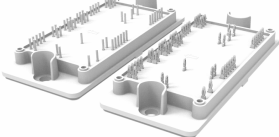
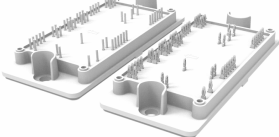
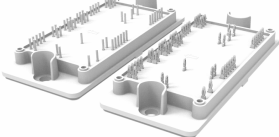
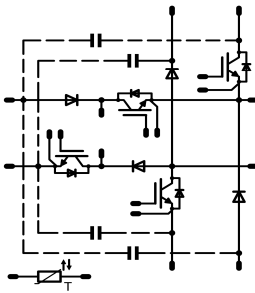
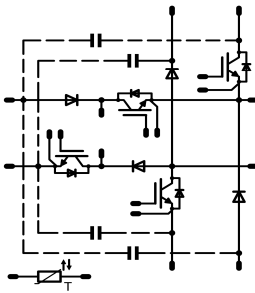
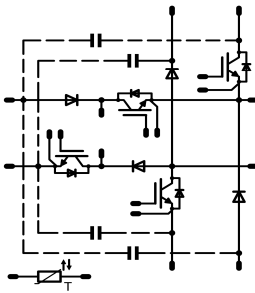

<i>flow 2</i> MNPC	1200 V / 200 A				
<table border="1" style="width: 100%; border-collapse: collapse;"> <thead> <tr style="background-color: #ccc;"> <th style="text-align: left; padding: 2px;">Features</th> </tr> </thead> <tbody> <tr> <td style="padding: 2px;"> <ul style="list-style-type: none"> <li>Mixed voltage NPC topology</li> <li>Reactive power capability</li> <li>Low inductance layout</li> <li>High speed IGBT and split output</li> <li>Common collector neutral connection</li> </ul> </td> </tr> </tbody> </table>	Features	<ul style="list-style-type: none"> <li>Mixed voltage NPC topology</li> <li>Reactive power capability</li> <li>Low inductance layout</li> <li>High speed IGBT and split output</li> <li>Common collector neutral connection</li> </ul>	<table border="1" style="width: 100%; border-collapse: collapse;"> <thead> <tr style="background-color: #ccc;"> <th style="text-align: left; padding: 2px;"><i>flow 2</i> 13mm housing</th> </tr> </thead> <tbody> <tr> <td style="text-align: center; padding: 5px;">  </td> </tr> </tbody> </table>	<i>flow 2</i> 13mm housing	
Features					
<ul style="list-style-type: none"> <li>Mixed voltage NPC topology</li> <li>Reactive power capability</li> <li>Low inductance layout</li> <li>High speed IGBT and split output</li> <li>Common collector neutral connection</li> </ul>					
<i>flow 2</i> 13mm housing					
					
<table border="1" style="width: 100%; border-collapse: collapse;"> <thead> <tr style="background-color: #ccc;"> <th style="text-align: left; padding: 2px;">Target Applications</th> </tr> </thead> <tbody> <tr> <td style="padding: 2px;"> <ul style="list-style-type: none"> <li>Solar inverter</li> <li>UPS</li> <li>Active frontend</li> </ul> </td> </tr> </tbody> </table>	Target Applications	<ul style="list-style-type: none"> <li>Solar inverter</li> <li>UPS</li> <li>Active frontend</li> </ul>	<table border="1" style="width: 100%; border-collapse: collapse;"> <thead> <tr style="background-color: #ccc;"> <th style="text-align: left; padding: 2px;">Schematic</th> </tr> </thead> <tbody> <tr> <td style="text-align: center; padding: 5px;">  </td> </tr> </tbody> </table>	Schematic	
Target Applications					
<ul style="list-style-type: none"> <li>Solar inverter</li> <li>UPS</li> <li>Active frontend</li> </ul>					
Schematic					
					
<table border="1" style="width: 100%; border-collapse: collapse;"> <thead> <tr style="background-color: #ccc;"> <th style="text-align: left; padding: 2px;">Types</th> </tr> </thead> <tbody> <tr> <td style="padding: 2px;"> <ul style="list-style-type: none"> <li>30-FT12NMA200SH-M660F08</li> <li>30-PT12NMA200SH-M660F08Y</li> </ul> </td> </tr> </tbody> </table>	Types	<ul style="list-style-type: none"> <li>30-FT12NMA200SH-M660F08</li> <li>30-PT12NMA200SH-M660F08Y</li> </ul>			
Types					
<ul style="list-style-type: none"> <li>30-FT12NMA200SH-M660F08</li> <li>30-PT12NMA200SH-M660F08Y</li> </ul>					

## Maximum Ratings

$T_j = 25\text{ °C}$ , unless otherwise specified

Parameter	Symbol	Condition	Value	Unit
<b>Half Bridge Sw. Protection Diode</b>				
Repetitive peak reverse voltage	$V_{RRM}$		1200	V
DC forward current	$I_F$	$T_j = T_{jmax}$ $T_s = 80\text{ °C}$	25	A
Maximum repetitive forward current	$I_{FRM}$	$t_p = 10\text{ ms}$	30	A
Power dissipation	$P_{tot}$	$T_s = 80\text{ °C}$	52	W
Maximum Junction Temperature	$T_{jmax}$		150	°C
<b>Half Bridge Switch</b>				
Collector-emitter breakdown voltage	$V_{CE}$		1200	V
DC collector current	$I_C$	$T_j = T_{jmax}$ $T_s = 80\text{ °C}$	171	A
Repetitive peak collector current	$I_{CRM}$	$t_p$ limited by $T_{jmax}$	600	A
Turn off safe operation area		$V_{CEmax} = 1200V, T_{vj} \leq 150\text{ °C}$	400	A
Power dissipation	$P_{tot}$	$T_j = T_{jmax}$ $T_s = 80\text{ °C}$	434	W
Gate-emitter peak voltage	$V_{GE}$		±20	V
Short circuit ratings	$t_{SC}$ $V_{CC}$	$T_j \leq 150\text{ °C}$ $V_{GE} = 15\text{ V}$	10 800	µs V
Maximum Junction Temperature	$T_{jmax}$		175	°C

**Maximum Ratings** $T_j = 25\text{ °C}$ , unless otherwise specified

Parameter	Symbol	Condition	Value	Unit
-----------	--------	-----------	-------	------

**Neutral Point FWD**

Peak Repetitive Reverse Voltage	$V_{RRM}$		700	V
DC forward current	$I_F$	$T_j = T_{jmax}$ $T_s = 80\text{ °C}$	87	A
Diode maximum forward current	$I_{FRM}$	$t_p$ limited by $T_{jmax}$	300	A
Power dissipation	$P_{tot}$	$T_j = T_{jmax}$ $T_s = 80\text{ °C}$	109	W
Maximum Junction Temperature	$T_{jmax}$		150	°C

**Neutral Point Switch**

Collector-emitter breakdown voltage	$V_{CE}$		600	V
DC collector current	$I_C$	$T_j = T_{jmax}$ $T_s = 80\text{ °C}$	124	A
Repetitive peak collector current	$I_{CRM}$	$t_p$ limited by $T_{jmax}$	450	A
Turn off safe operation area		$V_{CE} \leq 600V, T_j \leq 175\text{ °C}$	450	A
Power dissipation	$P_{tot}$	$T_j = T_{jmax}$ $T_s = 80\text{ °C}$	198	W
Gate-emitter peak voltage	$V_{GE}$		$\pm 20$	V
Short circuit ratings	$t_{SC}$ $V_{CC}$	$T_j \leq 150\text{ °C}$ $V_{GE} = 15\text{ V}$	6 360	$\mu s$ V
Maximum Junction Temperature	$T_{jmax}$		175	°C

**Neutral Point Sw. Protection Diode**

Peak Repetitive Reverse Voltage	$V_{RRM}$		600	V
DC forward current	$I_F$	$T_j = T_{jmax}$ $T_s = 80\text{ °C}$	49	A
Maximum repetitive forward current	$I_{FRM}$	$t_p$ limited by $T_{jmax}$	100	A
Power dissipation	$P_{tot}$	$T_j = T_{jmax}$ $T_s = 80\text{ °C}$	82	W
Maximum Junction Temperature	$T_{jmax}$		175	°C

**Half Bridge FWD**

Peak Repetitive Reverse Voltage	$V_{RRM}$		1200	V
DC forward current	$I_F$	$T_j = T_{jmax}$ $T_s = 80\text{ °C}$	84	A
Nonrepetitive peak surge current	$I_{FSM}$	$t_p$ limited by $T_{jmax}$	540	A
Power dissipation	$P_{tot}$	$T_j = T_{jmax}$ $T_s = 80\text{ °C}$	186	W
Maximum Junction Temperature	$T_{jmax}$		175	°C

**Maximum Ratings** $T_i = 25\text{ °C}$ , unless otherwise specified

Parameter	Symbol	Condition	Value	Unit
-----------	--------	-----------	-------	------

**Thermal Properties**

Storage temperature	$T_{stg}$		-40...+125	°C
Operation temperature under switching condition	$T_{op}$		-40...+( $T_{jmax} - 25$ )	°C

**Isolation Properties**

Isolation voltage	$V_{is}$	$t = 2\text{ s}$ DC Test Voltage	4000	V
Creepage distance			min 12,7	mm
Clearance			min 12,7	mm
Comparative tracking index	CTI		>200	



### Characteristic Values

Parameter	Symbol	Conditions					Value			Unit	
		$V_{GE}$ [V]	$V_{GS}$ [V]	$V_r$ [V]	$V_{CE}$ [V]	$V_{DS}$ [V]	$I_C$ [A]	$I_F$ [A]	$I_D$ [A]		$T_j$ [°C]

#### Half Bridge Sw. Protection Diode

Forward voltage	$V_F$					15	25 125			1,6	2,12 1,74	2,6	V
Thermal resistance junction to sink	$R_{th(j-s)}$	Thermal grease thickness $\leq 50\mu\text{m}$ $\lambda = 1 \text{ W/mK}$									1,35		K/W

#### Half Bridge Switch

Gate emitter threshold voltage	$V_{GE(th)}$	$V_{CE} = V_{GE}$				0,0068	25			5,2	5,8	6,4	V											
Collector-emitter saturation voltage	$V_{CEsat}$		15			200	25 125		2	2,17 2,58	2,4		V											
Collector-emitter cut-off current incl. Diode	$I_{CES}$		0	1200			25				24		$\mu\text{A}$											
Gate-emitter leakage current	$I_{GES}$		20	0			25					480	nA											
Integrated Gate resistor	$R_{gint}$										1		$\Omega$											
Turn-on delay time	$t_{d(on)}$	$R_{gon} = 2 \Omega$ $R_{goff} = 2 \Omega$	$\pm 15$	350	200		25				124		ns											
Rise time	$t_r$						125				27					126								
Turn-off delay time	$t_{d(off)}$						25				32					190								
Fall time	$t_f$						125				234					41								
Turn-on energy loss	$E_{on}$						25				61					2,38		mWs						
Turn-off energy loss	$E_{off}$						125				4,20					5,02								
Input capacitance	$C_{ies}$						$f = 1 \text{ MHz}$	0	25			25					11080		pF					
Output capacitance	$C_{oss}$																						1150	
Reverse transfer capacitance	$C_{rss}$																						640	
Gate charge	$Q_G$														15	960	160						960	
Thermal resistance junction to sink	$R_{th(j-s)}$	Thermal grease thickness $\leq 50\mu\text{m}$ $\lambda = 1 \text{ W/mK}$									0,22		K/W											

\*additional value stands for built-in capacitor

#### Neutral Point FWD

Diode forward voltage	$V_F$					150	25 125			1,4	1,80 1,61	3,3	V					
Peak reverse recovery current	$I_{RRM}$						25 125				130 169		A					
Reverse recovery time	$t_{rr}$	$R_{gon} = 2 \Omega$	$\pm 15$	350	200		25				93		ns					
Reverse recovered charge	$Q_{rr}$						125				118					4,47		
Peak rate of fall of recovery current	$(di_{rr}/dt)_{max}$						25				5241					1766		$\text{A}/\mu\text{s}$
Reverse recovered energy	$E_{rec}$						125				0,91					2,39		mWs
Thermal resistance junction to sink	$R_{th(j-s)}$						Thermal grease thickness $\leq 50\mu\text{m}$ $\lambda = 1 \text{ W/mK}$										0,64	



**Characteristic Values**

Parameter	Symbol	Conditions					Value			Unit	
		$V_{GE}$ [V]	$V_{GS}$ [V]	$V_r$ [V]	$V_{CE}$ [V]	$V_{DS}$ [V]	$I_C$ [A]	$I_F$ [A]	$I_D$ [A]		$T_j$ [°C]

**Neutral Point Switch**

Gate emitter threshold voltage	$V_{GE(th)}$	$V_{CE} = V_{GE}$				0,0024	25		5	5,8	6,5	V
Collector-emitter saturation voltage	$V_{CESat}$		15			150	25 125		1,05	1,57 1,68	1,85	V
Collector-emitter cut-off incl diode	$I_{CES}$		0	600			25				7,6	µA
Gate-emitter leakage current	$I_{GES}$		20	0			25				1200	nA
Integrated Gate resistor	$R_{gint}$									none		Ω
Turn-on delay time	$t_{d(on)}$						25 125			123 114		ns
Rise time	$t_r$						25 125			21 21		
Turn-off delay time	$t_{d(off)}$	$R_{goff} = 2 \Omega$ $R_{gonn} = 2 \Omega$	±15	350	150		25 125			168 177		
Fall time	$t_f$						25 125			38 59		
Turn-on energy loss	$E_{on}$						25 125			1,18 1,72		µWs
Turn-off energy loss	$E_{off}$						25 125			3,59 5,13		
Input capacitance	$C_{ies}$									9240		pF
Output capacitance	$C_{oss}$	$f = 1 \text{ MHz}$	15	480	150					576		
Reverse transfer capacitance	$C_{rss}$						25			274		
Gate charge	$Q_G$		15	480	150					940		nC
Thermal resistance junction to sink	$R_{th(j-s)}$	Thermal grease thickness ≤ 50µm $\lambda = 1 \text{ W/mK}$								0,48		K/W

**Neutral Point Sw. Protection Diode**

Diode forward voltage	$V_F$					50	25 125		1,20	1,78 1,70	1,90	V
Thermal resistance junction to sink	$R_{th(j-s)}$	Thermal grease thickness ≤ 50µm $\lambda = 1 \text{ W/mK}$								1,16		K/W

**Half Bridge FWD**

Diode forward voltage	$V_F$					100	25 150		1,50	2,23 2,34	2,54	V
Reverse leakage current	$I_r$			1200			25				120	µA
Peak reverse recovery current	$I_{RRM}$						25 150			184 216		A
Reverse recovery time	$t_{rr}$						25 150			48 114		ns
Reverse recovered charge	$Q_{rr}$	$R_{gonn} = 2 \Omega$	±15	350	100		25 150			6,62 12,94		µC
Peak rate of fall of recovery current	$(di_{rr}/dt)_{max}$						25 150			11659 9489		A/µs
Reverse recovery energy	$E_{rec}$						25 150			1,62 3,42		mWs
Thermal resistance junction to sink	$R_{th(j-s)}$	Thermal grease thickness ≤ 50µm $\lambda = 1 \text{ W/mK}$								0,51		K/W

**Thermistor**

Rated resistance	$R$						25			22000		Ω
Deviation of $R_{100}$	$\Delta_{R/R}$	$R_{100} = 1486 \Omega$					100		-5		+5	%
Power dissipation	$P$						25			200		mW
Power dissipation constant							25			2		mW/K
B-value	$B_{(25/50)}$	Tol. ±3%					25			3950		K
B-value	$B_{(25/100)}$	Tol. ±3%					25			3998		K
Vincotech NTC Reference											B	



# Half Bridge

## Half Bridge IGBT and Neutral Point FWD

figure 1. IGBT

Typical output characteristics

$I_C = f(V_{CE})$

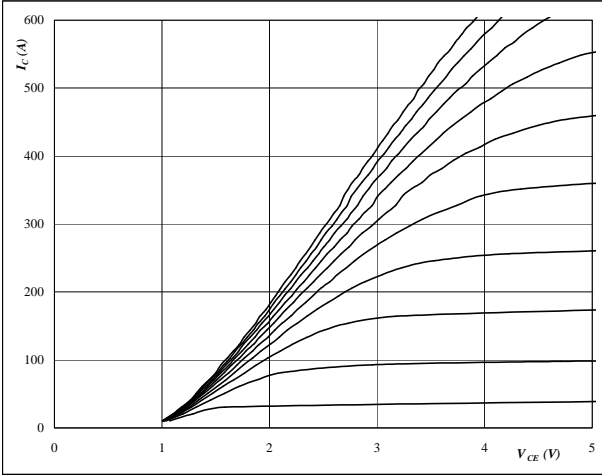

At

- $t_p = 250 \mu s$
- $T_j = 25 \text{ } ^\circ C$
- $V_{GE}$  from 7 V to 17 V in steps of 1 V

figure 2. IGBT

Typical output characteristics

$I_C = f(V_{CE})$

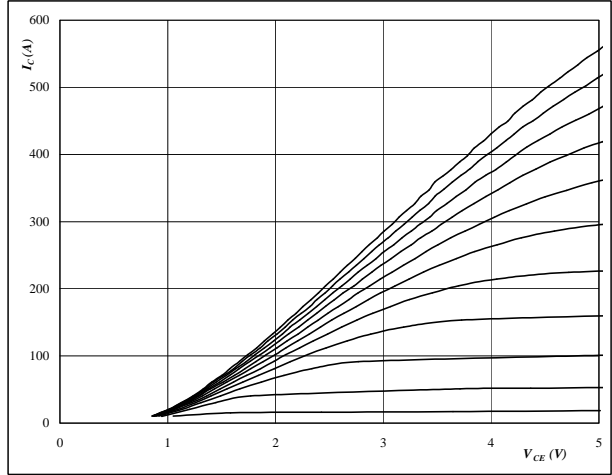

At

- $t_p = 250 \mu s$
- $T_j = 125 \text{ } ^\circ C$
- $V_{GE}$  from 7 V to 17 V in steps of 1 V

figure 3. IGBT

Typical transfer characteristics

$I_C = f(V_{GE})$

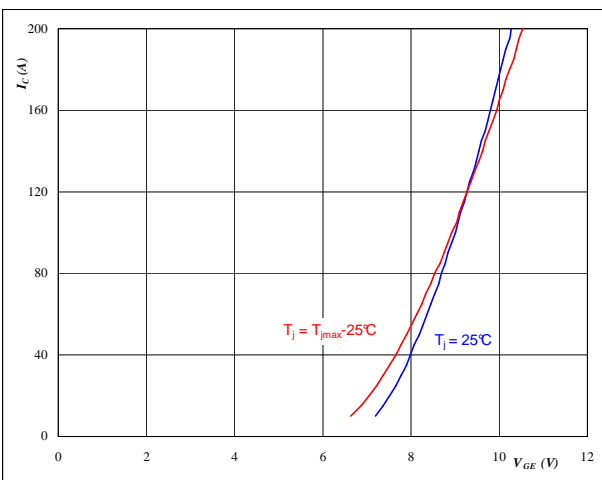

At

- $t_p = 250 \mu s$
- $V_{CE} = 10 \text{ V}$
- $T_j = 25/150 \text{ } ^\circ C$

figure 4. FWD

Typical FWD forward current as a function of forward voltage

$I_F = f(V_F)$

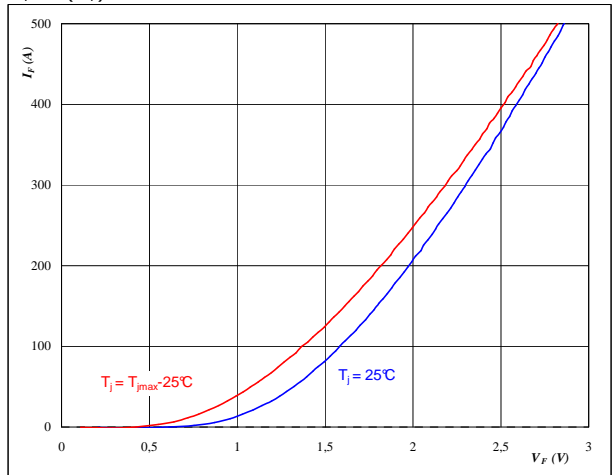

At

- $t_p = 250 \mu s$
- $T_j = 25/150 \text{ } ^\circ C$



## Half Bridge

### Half Bridge IGBT and Neutral Point FWD

**figure 5.** IGBT

Typical switching energy losses  
as a function of collector current

$$E = f(I_C)$$

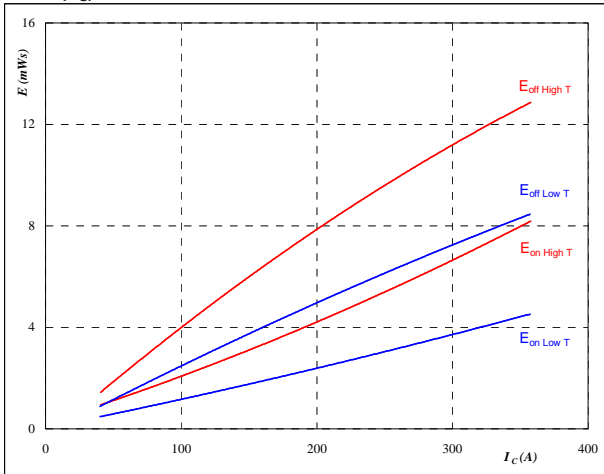

With an inductive load at

$T_j = 25/125 \text{ } ^\circ\text{C}$   
 $V_{CE} = 350 \text{ V}$   
 $V_{GE} = \pm 15 \text{ V}$   
 $R_{gon} = 2 \text{ } \Omega$   
 $R_{goff} = 2 \text{ } \Omega$

**figure 6.** IGBT

Typical switching energy losses  
as a function of gate resistor

$$E = f(R_G)$$

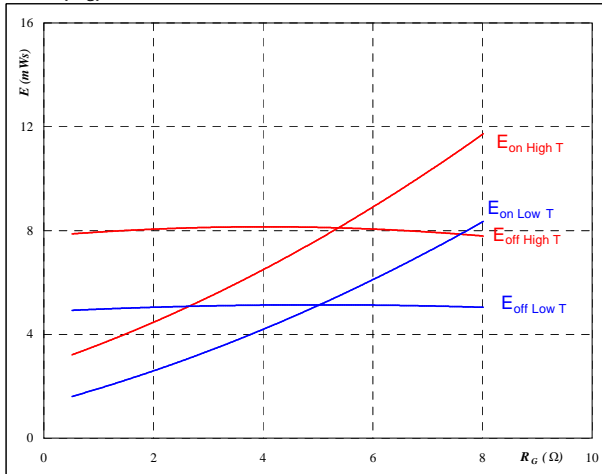

With an inductive load at

$T_j = 25/125 \text{ } ^\circ\text{C}$   
 $V_{CE} = 350 \text{ V}$   
 $V_{GE} = \pm 15 \text{ V}$   
 $I_C = 198 \text{ A}$

**figure 7.** FWD

Typical reverse recovery energy loss  
as a function of collector current

$$E_{rec} = f(I_C)$$

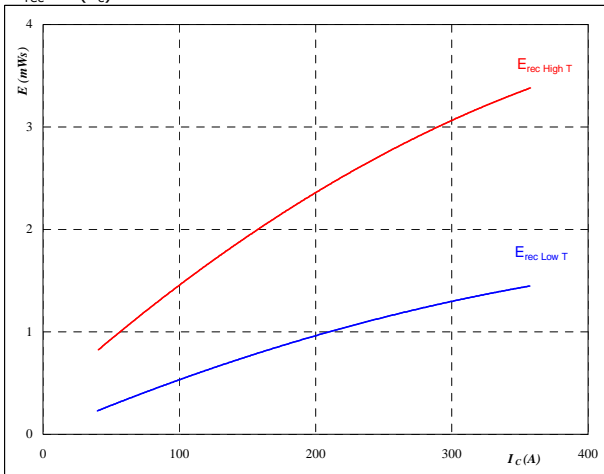

With an inductive load at

$T_j = 25/125 \text{ } ^\circ\text{C}$   
 $V_{CE} = 350 \text{ V}$   
 $V_{GE} = \pm 15 \text{ V}$   
 $R_{gon} = 2 \text{ } \Omega$

**figure 8.** FWD

Typical reverse recovery energy loss  
as a function of gate resistor

$$E_{rec} = f(R_G)$$

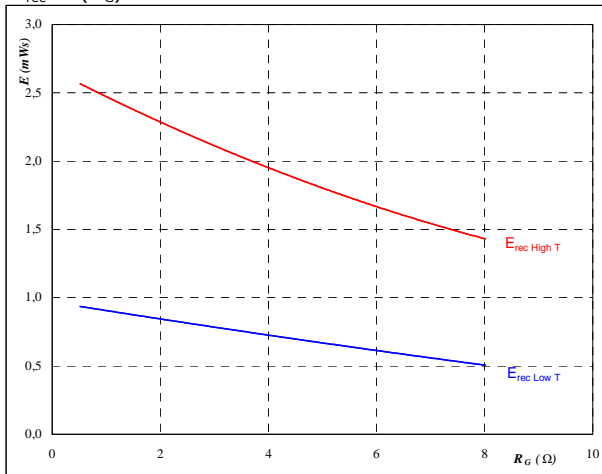

With an inductive load at

$T_j = 25/125 \text{ } ^\circ\text{C}$   
 $V_{CE} = 350 \text{ V}$   
 $V_{GE} = \pm 15 \text{ V}$   
 $I_C = 198 \text{ A}$



### Half Bridge

#### Half Bridge IGBT and Neutral Point FWD

figure 9. IGBT

Typical switching times as a function of collector current

$t = f(I_C)$

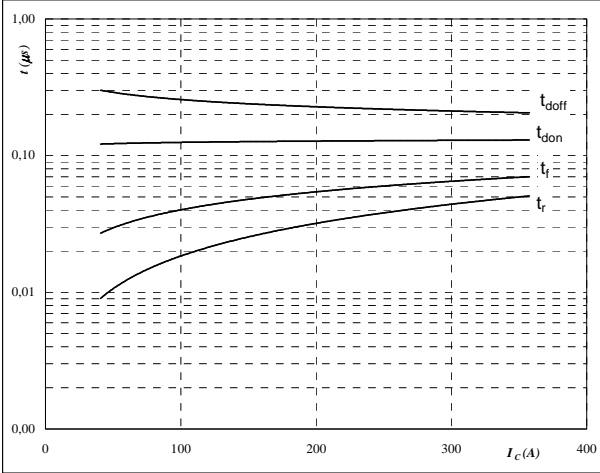

With an inductive load at

- $T_j = 125 \text{ } ^\circ\text{C}$
- $V_{CE} = 350 \text{ V}$
- $V_{GE} = \pm 15 \text{ V}$
- $R_{gon} = 2 \text{ } \Omega$
- $R_{goff} = 2 \text{ } \Omega$

figure 10. IGBT

Typical switching times as a function of gate resistor

$t = f(R_G)$

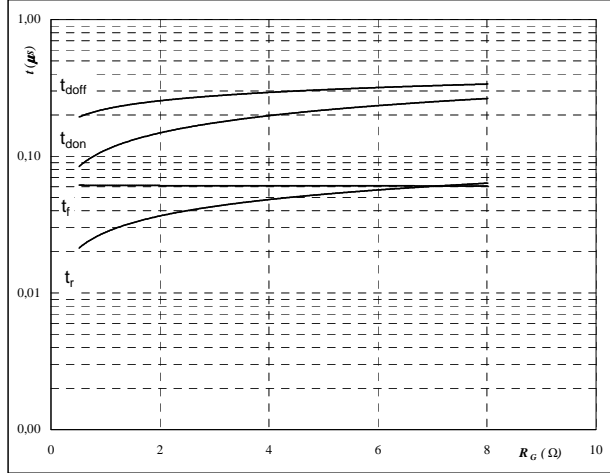

With an inductive load at

- $T_j = 125 \text{ } ^\circ\text{C}$
- $V_{CE} = 350 \text{ V}$
- $V_{GE} = \pm 15 \text{ V}$
- $I_C = 198 \text{ A}$

figure 11. FWD

Typical reverse recovery time as a function of collector current

$t_{rr} = f(I_C)$

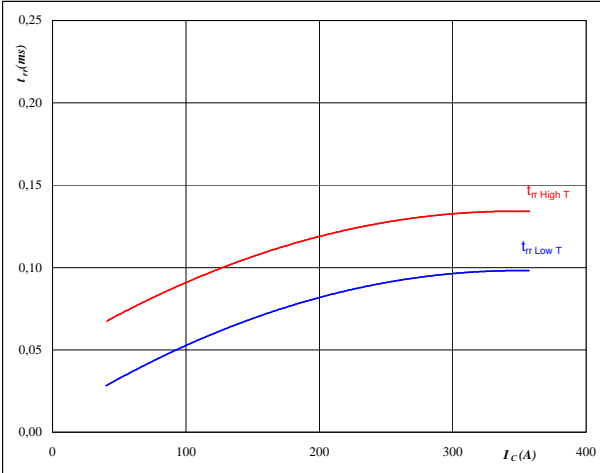

At

- $T_j = 25/125 \text{ } ^\circ\text{C}$
- $V_{CE} = 350 \text{ V}$
- $V_{GE} = \pm 15 \text{ V}$
- $R_{gon} = 2 \text{ } \Omega$

figure 12. FWD

Typical reverse recovery time as a function of IGBT turn on gate resistor

$t_{rr} = f(R_{gon})$

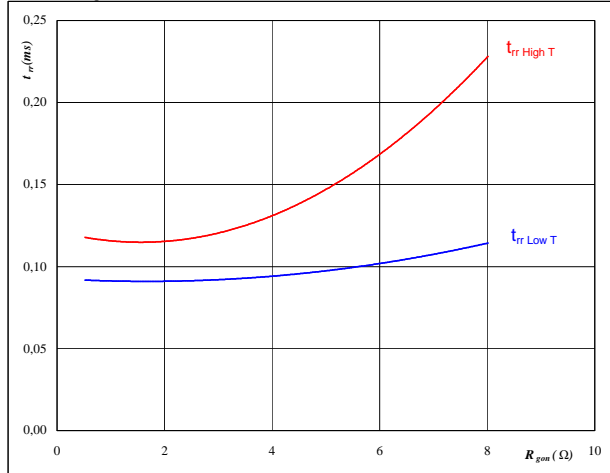

At

- $T_j = 25/125 \text{ } ^\circ\text{C}$
- $V_R = 350 \text{ V}$
- $I_F = 198 \text{ A}$
- $V_{GE} = \pm 15 \text{ V}$





### Half Bridge

#### Half Bridge IGBT and Neutral Point FWD

**figure 13.** FWD

Typical reverse recovery charge as a function of collector current

$$Q_{rr} = f(I_C)$$

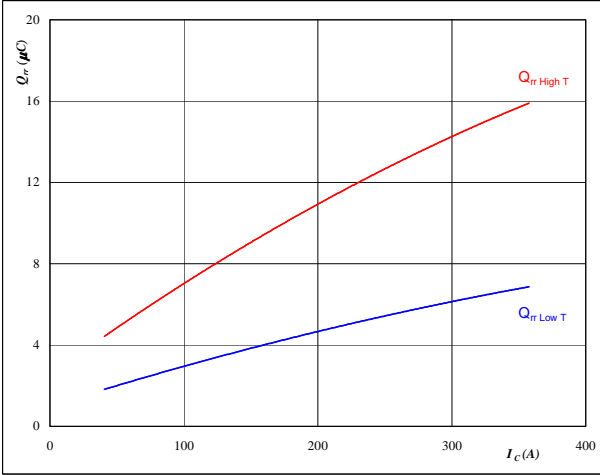

**At**  
 $T_j = 25/125$  °C  
 $V_{CE} = 350$  V  
 $V_{GE} = \pm 15$  V  
 $R_{gon} = 2$  Ω

**figure 14.** FWD

Typical reverse recovery charge as a function of IGBT turn on gate resistor

$$Q_{rr} = f(R_{gon})$$

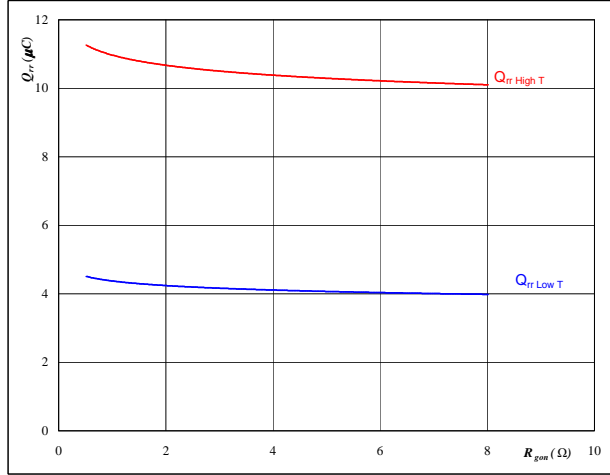

**At**  
 $T_j = 25/125$  °C  
 $V_R = 350$  V  
 $I_F = 198$  A  
 $V_{GE} = \pm 15$  V

**figure 15.** FWD

Typical reverse recovery current as a function of collector current

$$I_{RRM} = f(I_C)$$

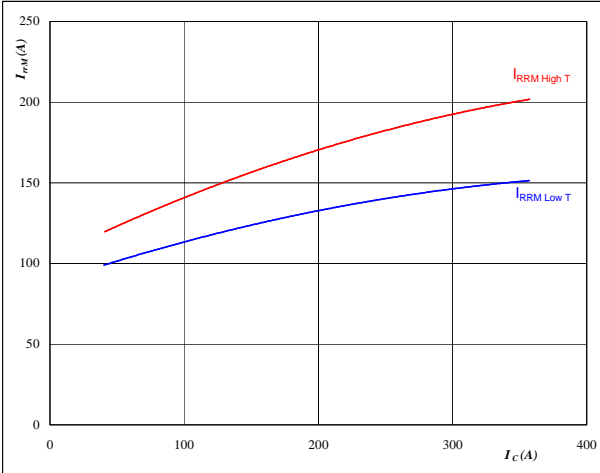

**At**  
 $T_j = 25/125$  °C  
 $V_{CE} = 350$  V  
 $V_{GE} = \pm 15$  V  
 $R_{gon} = 2$  Ω

**figure 16.** FWD

Typical reverse recovery current as a function of IGBT turn on gate resistor

$$I_{RRM} = f(R_{gon})$$

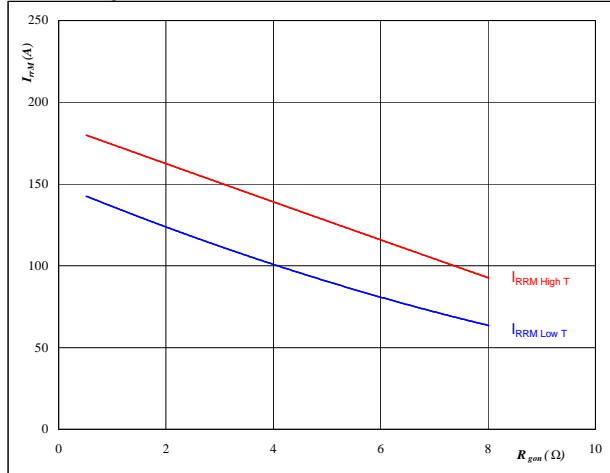

**At**  
 $T_j = 25/125$  °C  
 $V_R = 350$  V  
 $I_F = 198$  A  
 $V_{GE} = \pm 15$  V



### Half Bridge

#### Half Bridge IGBT and Neutral Point FWD

**figure 17.** FWD

Typical rate of fall of forward and reverse recovery current as a function of collector current

$$dI_0/dt, dI_{rec}/dt = f(I_c)$$

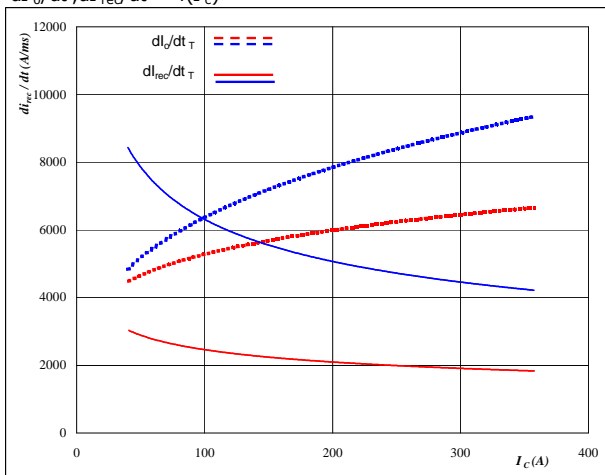

**At**  
 $T_j = 25/125 \text{ } ^\circ\text{C}$   
 $V_{CE} = 350 \text{ V}$   
 $V_{GE} = \pm 15 \text{ V}$   
 $R_{gon} = 2 \text{ } \Omega$

**figure 18.** FWD

Typical rate of fall of forward and reverse recovery current as a function of IGBT turn on gate resistor

$$dI_0/dt, dI_{rec}/dt = f(R_{gon})$$

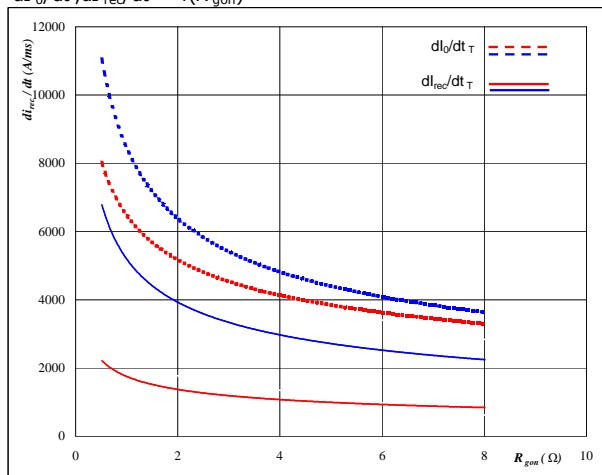

**At**  
 $T_j = 25/125 \text{ } ^\circ\text{C}$   
 $V_R = 350 \text{ V}$   
 $I_F = 198 \text{ A}$   
 $V_{GE} = \pm 15 \text{ V}$

**figure 19.** IGBT

IGBT transient thermal impedance as a function of pulse width

$$Z_{th(j-s)} = f(t_p)$$

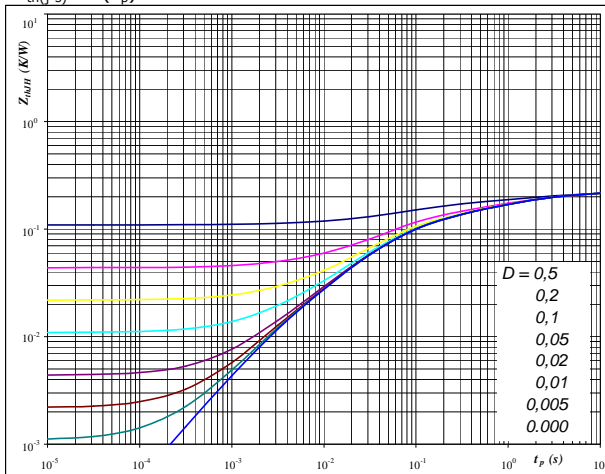

**At**  
 $D = t_p / T$   
 $R_{th(j-s)} = 0,22 \text{ K/W}$

IGBT thermal model values

R (K/W)	Tau (s)
0,04	4,0E+00
0,05	9,4E-01
0,04	2,3E-01
0,07	5,4E-02
0,02	1,6E-02
0,01	2,8E-03

**figure 20.** FWD

FWD transient thermal impedance as a function of pulse width

$$Z_{th(j-s)} = f(t_p)$$

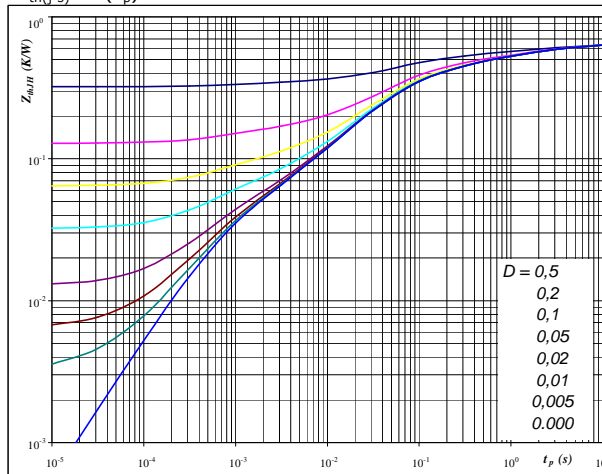

**At**  
 $D = t_p / T$   
 $R_{th(j-s)} = 0,64 \text{ K/W}$

FWD thermal model values

R (K/W)	Tau (s)
0,09	4,6E+00
0,11	1,2E+00
0,16	1,8E-01
0,23	3,8E-02
0,03	5,8E-03
0,03	7,4E-04



### Half Bridge

#### Half Bridge IGBT and Neutral Point FWD

**figure 21.** IGBT

**Power dissipation as a function of heatsink temperature**

$$P_{tot} = f(T_s)$$

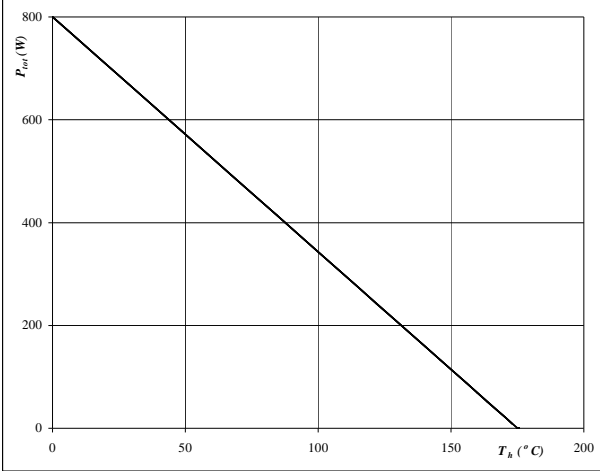

**At**  
T<sub>j</sub> = 175 °C

**figure 22.** IGBT

**Collector current as a function of heatsink temperature**

$$I_C = f(T_s)$$

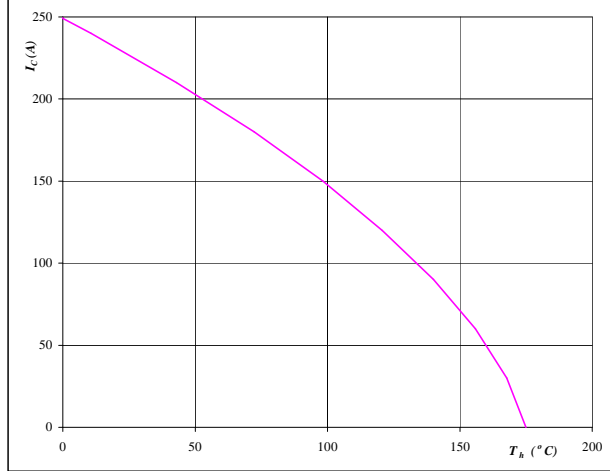

**At**  
T<sub>j</sub> = 175 °C  
V<sub>GE</sub> = 15 V

**figure 23.** FWD

**Power dissipation as a function of heatsink temperature**

$$P_{tot} = f(T_s)$$

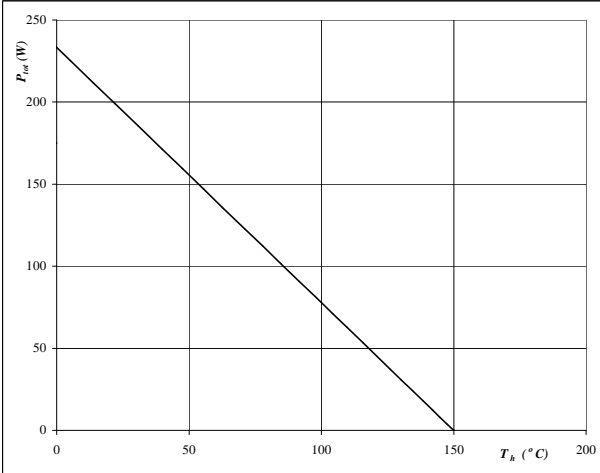

**At**  
T<sub>j</sub> = 150 °C

**figure 24.** FWD

**Forward current as a function of heatsink temperature**

$$I_F = f(T_s)$$

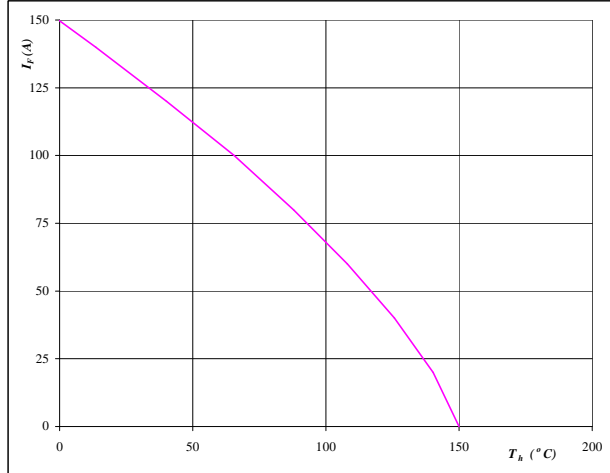

**At**  
T<sub>j</sub> = 150 °C



### Half Bridge

#### Half Bridge IGBT and Neutral Point FWD

**figure 25.** IGBT

Safe operating area as a function of collector-emitter voltage

$I_C = f(V_{CE})$

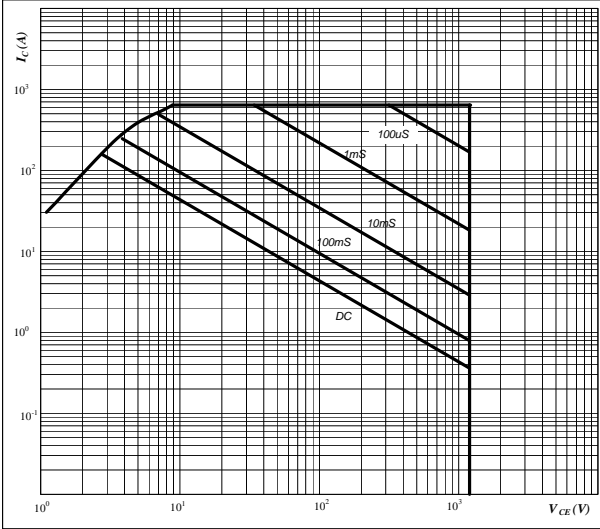

**At**  
 $D =$  single pulse  
 $T_s =$  80 °C  
 $V_{GE} =$  ±15 V  
 $T_j = T_{jmax}$  °C

**figure 26.** IGBT

Gate voltage vs Gate charge

$V_{GE} = f(Q_g)$

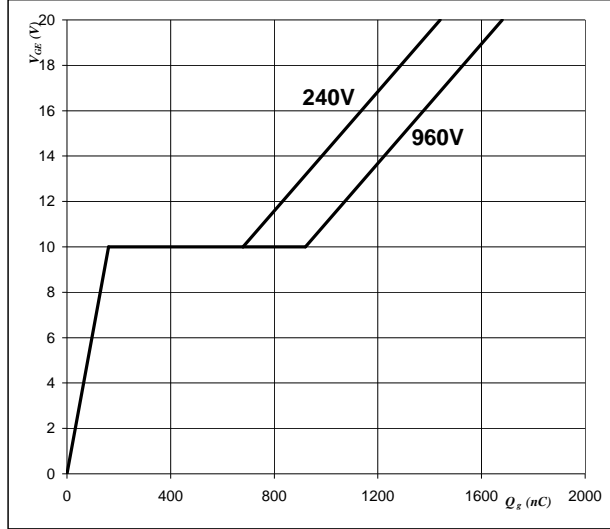

**At**  
 $I_D =$  160 A  
 $T_j =$  25 °C

**figure 27.** IGBT

Short circuit withstand time as a function of gate-emitter voltage

$t_{sc} = f(V_{GE})$

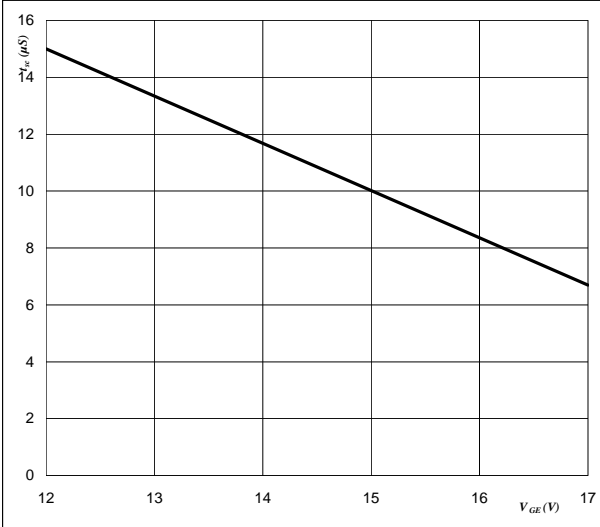

**At**  
 $V_{CE} =$  1200 V  
 $T_j \leq$  175 °C

**figure 28.** IGBT

Typical short circuit collector current as a function of gate-emitter voltage

$I_{C(sc)} = f(V_{GE})$

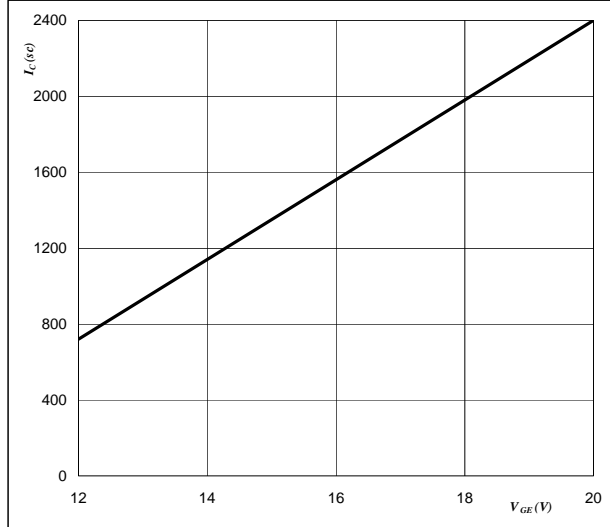

**At**  
 $V_{CE} \leq$  1200 V  
 $T_j =$  175 °C



# Half Bridge

## Half Bridge IGBT and Neutral Point FWD

**figure 27.** IGBT  
**Reverse bias safe operating area**

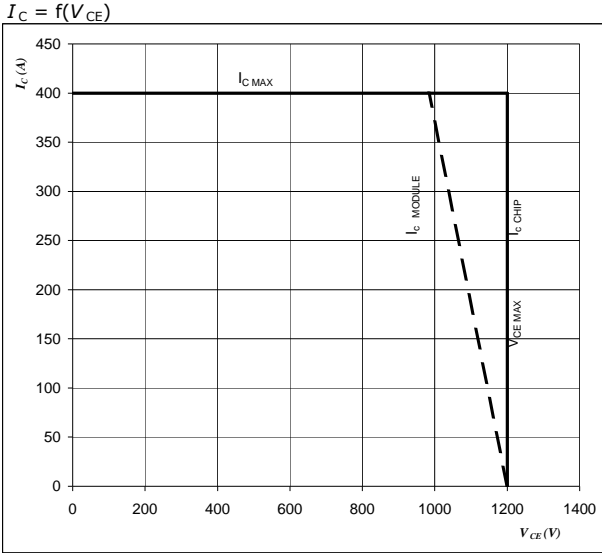

**At**

$$T_j = T_{jmax} - 25 \text{ } ^\circ\text{C}$$

$$U_{ccminus} = U_{ccplus}$$

Switching mode : 3 level switching



### Neutral Point

#### Neutral Point IGBT and Half Bridge FWD

**figure 1.** IGBT

Typical output characteristics

$$I_C = f(V_{CE})$$

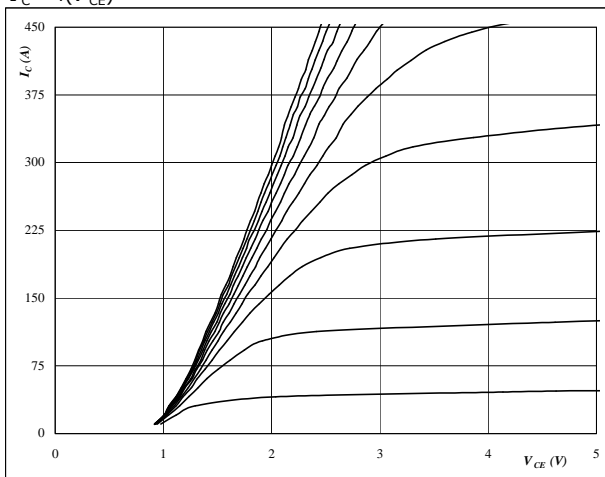

At

$t_p = 250 \mu s$   
 $T_j = 25 \text{ } ^\circ C$   
 $V_{GE}$  from 7 V to 17 V in steps of 1 V

**figure 2.** IGBT

Typical output characteristics

$$I_C = f(V_{CE})$$

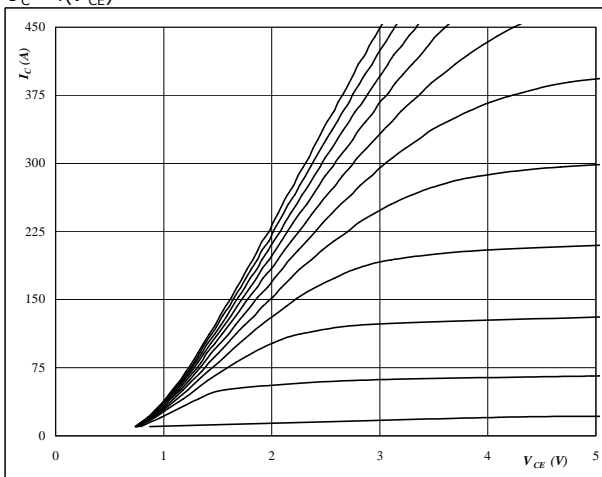

At

$t_p = 250 \mu s$   
 $T_j = 150 \text{ } ^\circ C$   
 $V_{GE}$  from 7 V to 17 V in steps of 1 V

**figure 3.** IGBT

Typical transfer characteristics

$$I_C = f(V_{GE})$$

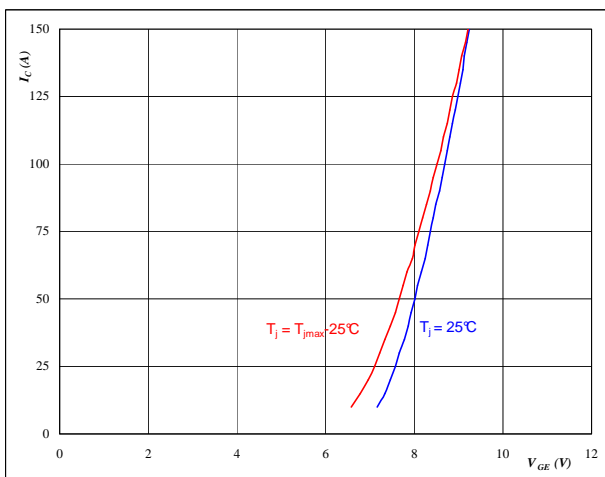

At

$t_p = 250 \mu s$   
 $V_{CE} = 0 \text{ V}$   
 $T_j = 25/150 \text{ } ^\circ C$

**figure 4.** FWD

Typical FWD forward current as a function of forward voltage

$$I_F = f(V_F)$$

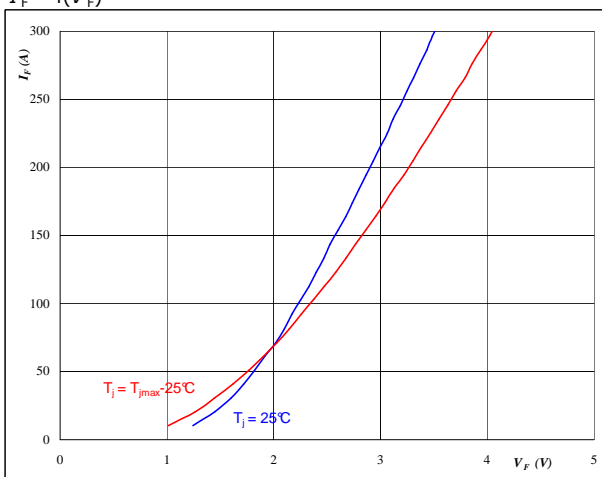

At

$t_p = 250 \mu s$   
 $T_j = 25/150 \text{ } ^\circ C$



### Neutral Point

#### Neutral Point IGBT and Half Bridge FWD

figure 5. IGBT

Typical switching energy losses  
as a function of collector current

$E = f(I_C)$

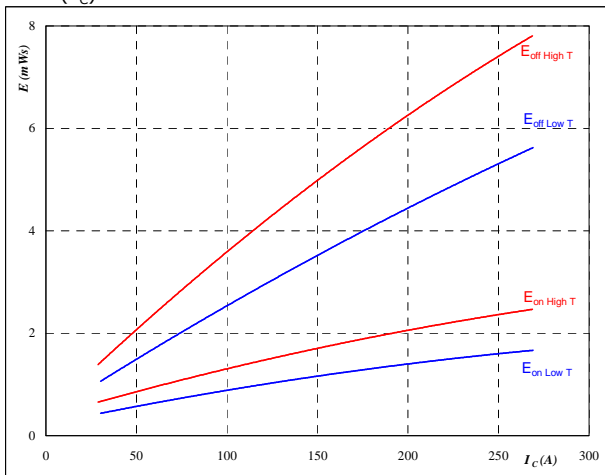

With an inductive load at

- $T_j = 25/126 \text{ } ^\circ\text{C}$
- $V_{CE} = 350 \text{ V}$
- $V_{GE} = \pm 15 \text{ V}$
- $R_{gon} = 2 \text{ } \Omega$
- $R_{goff} = 2 \text{ } \Omega$

figure 6. IGBT

Typical switching energy losses  
as a function of gate resistor

$E = f(R_G)$

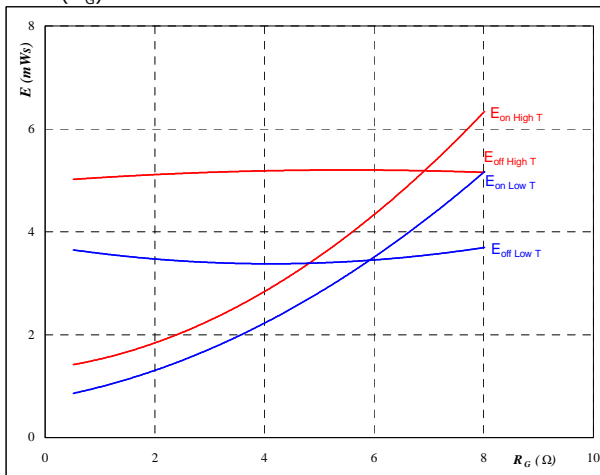

With an inductive load at

- $T_j = 25/126 \text{ } ^\circ\text{C}$
- $V_{CE} = 350 \text{ V}$
- $V_{GE} = \pm 15 \text{ V}$
- $I_C = 151 \text{ A}$

figure 7. FWD

Typical reverse recovery energy loss  
as a function of collector current

$E_{rec} = f(I_C)$

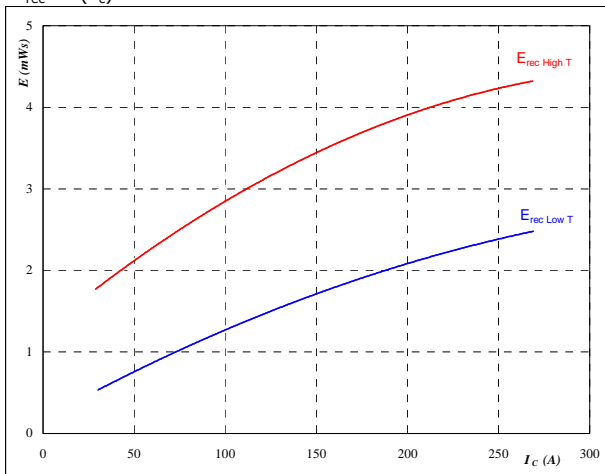

With an inductive load at

- $T_j = 25/126 \text{ } ^\circ\text{C}$
- $V_{CE} = 350 \text{ V}$
- $V_{GE} = \pm 15 \text{ V}$
- $R_{gon} = 2 \text{ } \Omega$

figure 8. FWD

Typical reverse recovery energy loss  
as a function of gate resistor

$E_{rec} = f(R_G)$

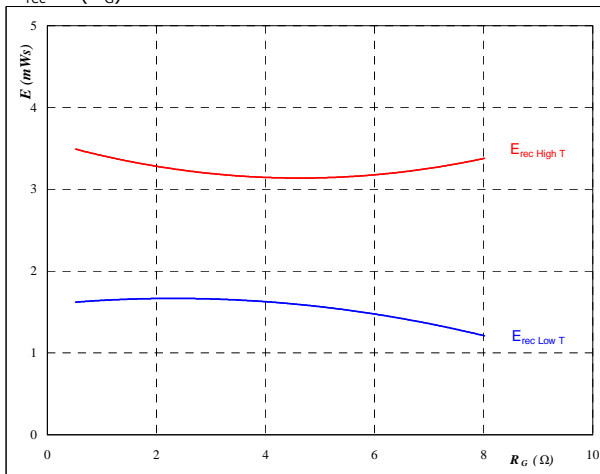

With an inductive load at

- $T_j = 25/126 \text{ } ^\circ\text{C}$
- $V_{CE} = 350 \text{ V}$
- $V_{GE} = \pm 15 \text{ V}$
- $I_C = 151 \text{ A}$



## Neutral Point

### Neutral Point IGBT and Half Bridge FWD

**figure 9. IGBT**

Typical switching times as a function of collector current

$$t = f(I_C)$$

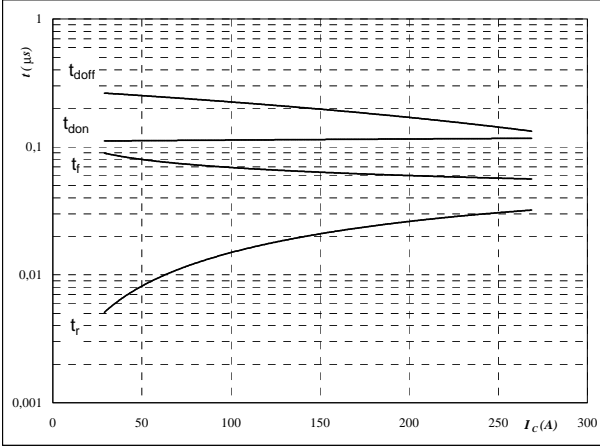

With an inductive load at

$T_j =$	126	°C
$V_{CE} =$	350	V
$V_{GE} =$	±15	V
$R_{gon} =$	2	Ω
$R_{goff} =$	2	Ω

**figure 10. IGBT**

Typical switching times as a function of gate resistor

$$t = f(R_G)$$

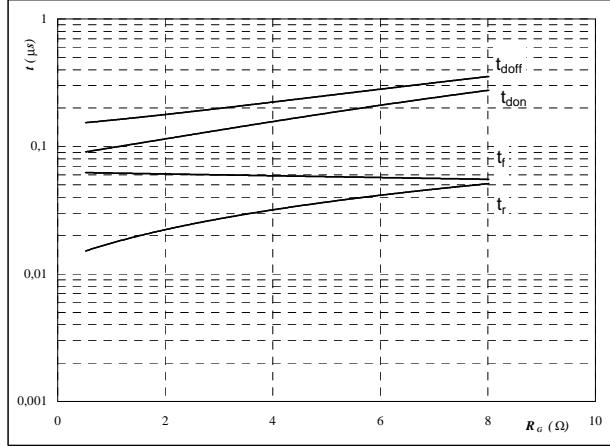

With an inductive load at

$T_j =$	126	°C
$V_{CE} =$	350	V
$V_{GE} =$	±15	V
$I_C =$	151	A

**figure 11. FWD**

Typical reverse recovery time as a function of collector current

$$t_{rr} = f(I_C)$$

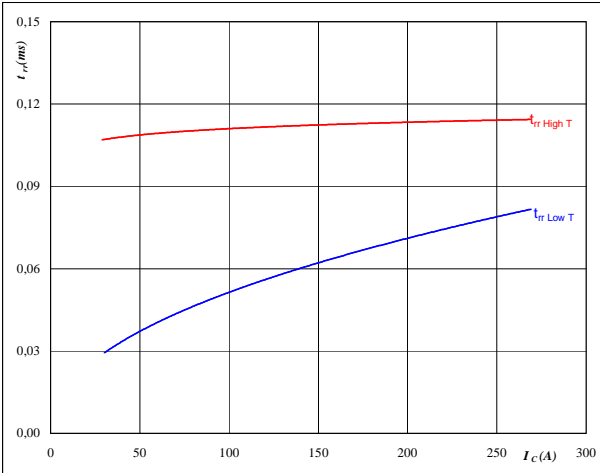

**At**

$T_j =$	25/126	°C
$V_{CE} =$	350	V
$V_{GE} =$	±15	V
$R_{gon} =$	2	Ω

**figure 12. FWD**

Typical reverse recovery time as a function of IGBT turn on gate resistor

$$t_{rr} = f(R_{gon})$$

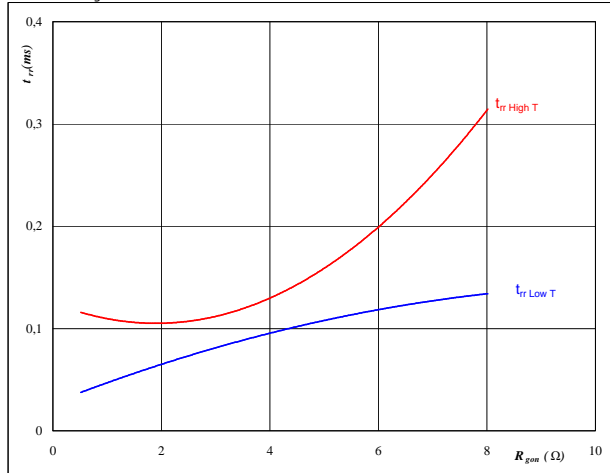

**At**

$T_j =$	25/126	°C
$V_R =$	350	V
$I_F =$	151	A
$V_{GE} =$	±15	V





## Neutral Point

### Neutral Point IGBT and Half Bridge FWD

**figure 13.** FWD**Typical reverse recovery charge as a function of collector current**

$$Q_{rr} = f(I_C)$$

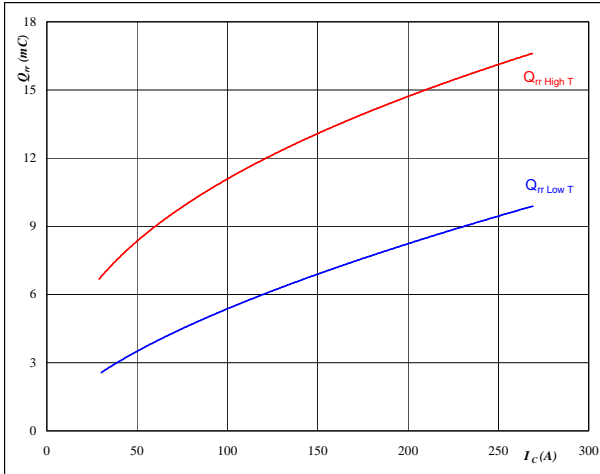
**At**

$T_j =$	25/126	°C
$V_{CE} =$	350	V
$V_{GE} =$	±15	V
$R_{gon} =$	2	Ω

**figure 14.** FWD**Typical reverse recovery charge as a function of IGBT turn on gate resistor**

$$Q_{rr} = f(R_{gon})$$

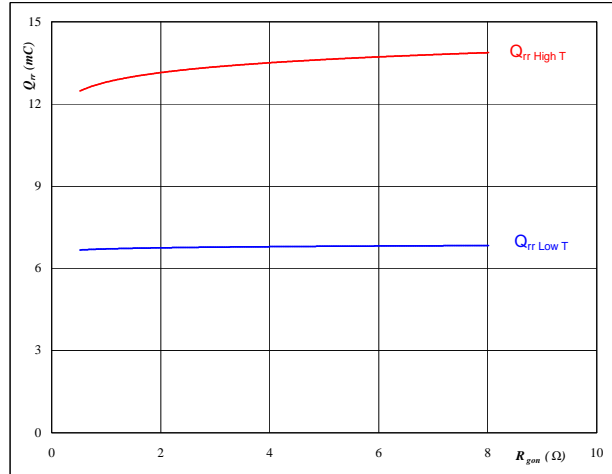
**At**

$T_j =$	25/126	°C
$V_R =$	350	V
$I_F =$	151	A
$V_{GE} =$	±15	V

**figure 15.** FWD**Typical reverse recovery current as a function of collector current**

$$I_{RRM} = f(I_C)$$

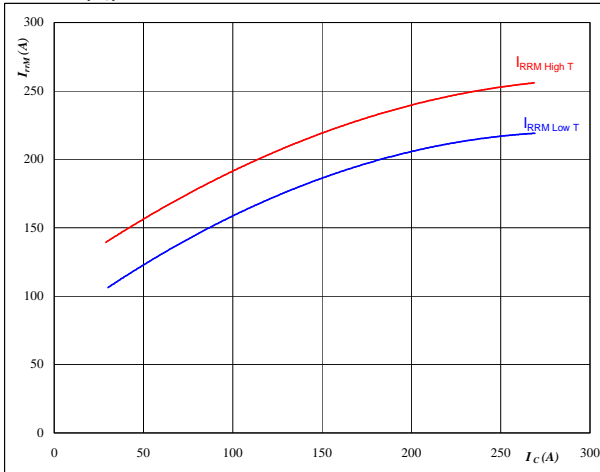
**At**

$T_j =$	25/126	°C
$V_{CE} =$	350	V
$V_{GE} =$	±15	V
$R_{gon} =$	2	Ω

**figure 16.** FWD**Typical reverse recovery current as a function of IGBT turn on gate resistor**

$$I_{RRM} = f(R_{gon})$$

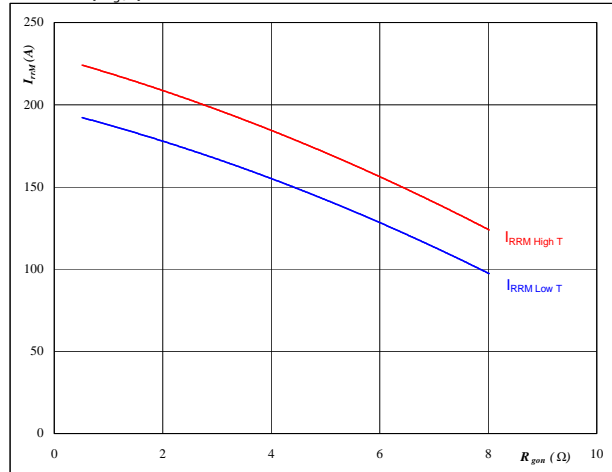
**At**

$T_j =$	25/126	°C
$V_R =$	350	V
$I_F =$	151	A
$V_{GE} =$	±15	V



## Neutral Point

### Neutral Point IGBT and Half Bridge FWD

**figure 17.** **FWD**

Typical rate of fall of forward and reverse recovery current as a function of collector current

$$dI_0/dt, dI_{rec}/dt = f(I_c)$$

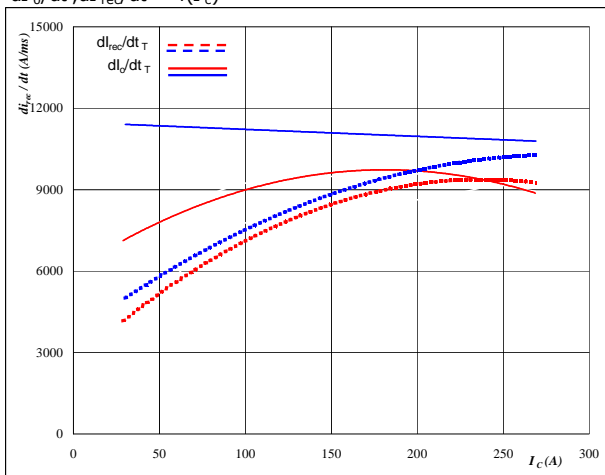

**At**  
 $T_j = 25/126 \text{ } ^\circ\text{C}$   
 $V_{CE} = 350 \text{ V}$   
 $V_{GE} = \pm 15 \text{ V}$   
 $R_{gon} = 2 \text{ } \Omega$

**figure 18.** **FWD**

Typical rate of fall of forward and reverse recovery current as a function of IGBT turn on gate resistor

$$dI_0/dt, dI_{rec}/dt = f(R_{gon})$$

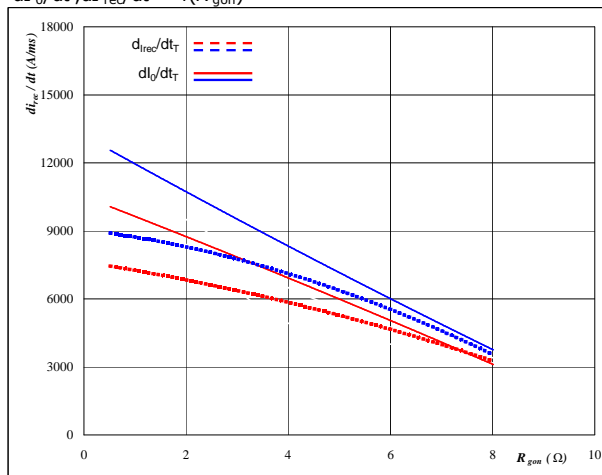

**At**  
 $T_j = 25/126 \text{ } ^\circ\text{C}$   
 $V_R = 350 \text{ V}$   
 $I_F = 151 \text{ A}$   
 $V_{GE} = \pm 15 \text{ V}$

**figure 19.** **IGBT**

IGBT transient thermal impedance as a function of pulse width

$$Z_{th(j-s)} = f(t_p)$$

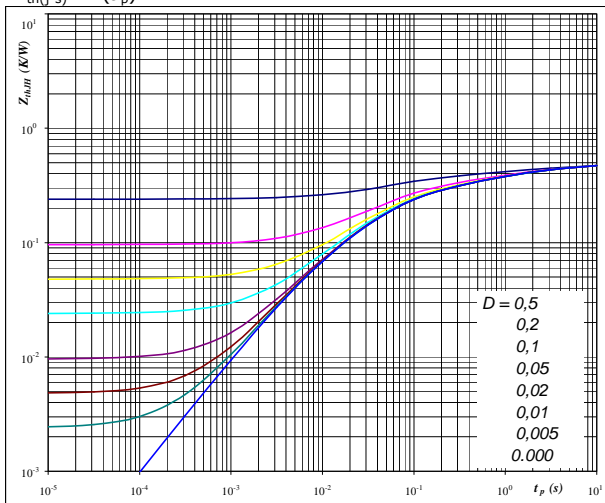

**At**  
 $D = t_p / T$   
 $R_{th(j-s)} = 0,48 \text{ K/W}$

IGBT thermal model values

R (K/W)	Tau (s)
0,09	4,40
0,11	0,76
0,10	0,13
0,15	0,03
0,02	0,01

**figure 20.** **FWD**

FWD transient thermal impedance as a function of pulse width

$$Z_{th(j-s)} = f(t_p)$$

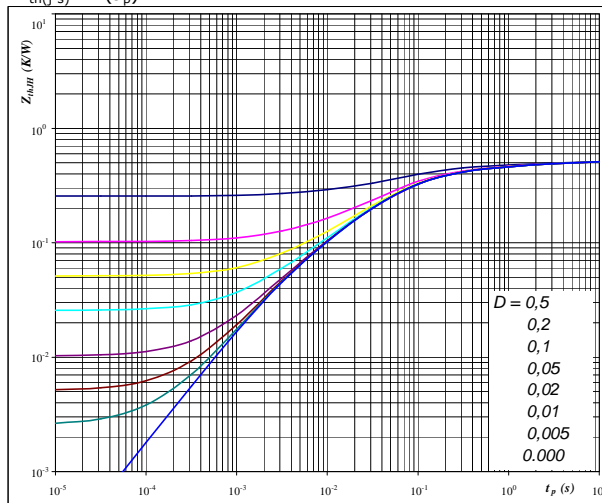

**At**  
 $D = t_p / T$   
 $R_{th(j-s)} = 0,51 \text{ K/W}$

FWD thermal model values

R (K/W)	Tau (s)
0,06	3,05
0,08	0,45
0,20	0,09
0,14	0,03
0,04	0,004



### Neutral Point

#### Neutral Point IGBT and Half Bridge FWD

**figure 21. IGBT**

**Power dissipation as a function of heatsink temperature**

$$P_{tot} = f(T_s)$$

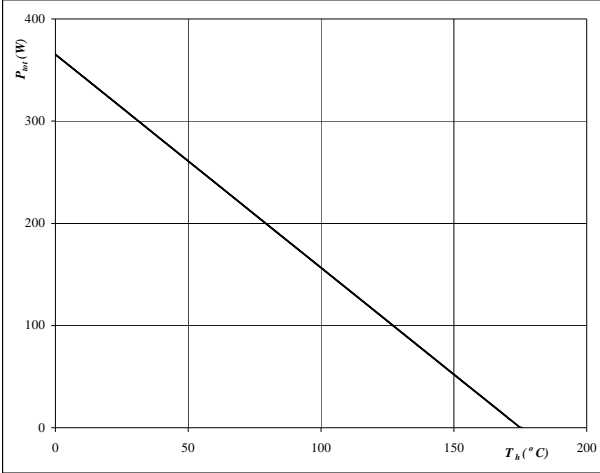

**At**  
T<sub>j</sub> = 175 °C

**figure 22. IGBT**

**Collector current as a function of heatsink temperature**

$$I_C = f(T_s)$$

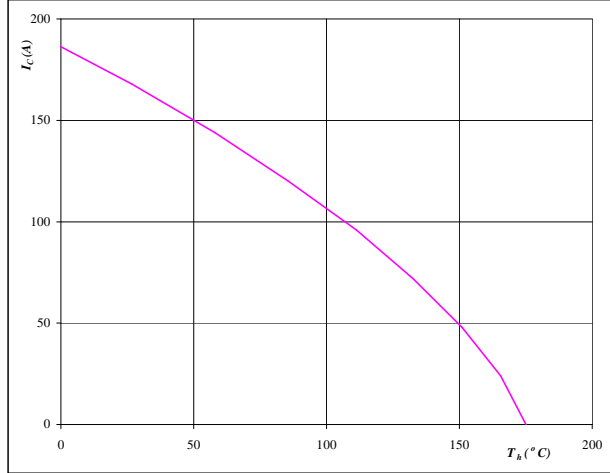

**At**  
T<sub>j</sub> = 175 °C  
V<sub>GE</sub> = 15 V

**figure 23. FWD**

**Power dissipation as a function of heatsink temperature**

$$P_{tot} = f(T_s)$$

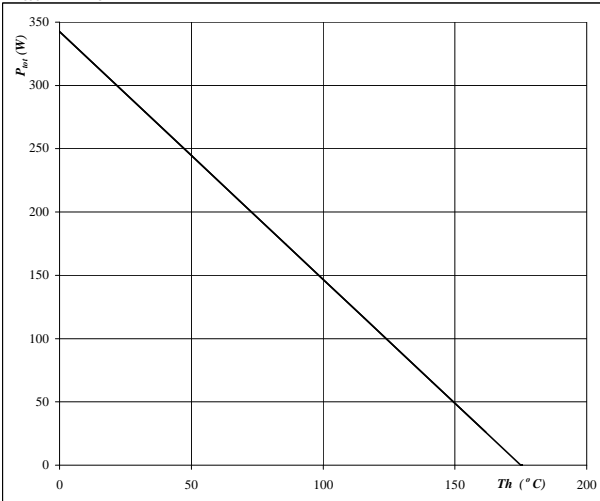

**At**  
T<sub>j</sub> = 175 °C

**figure 24. FWD**

**Forward current as a function of heatsink temperature**

$$I_F = f(T_s)$$

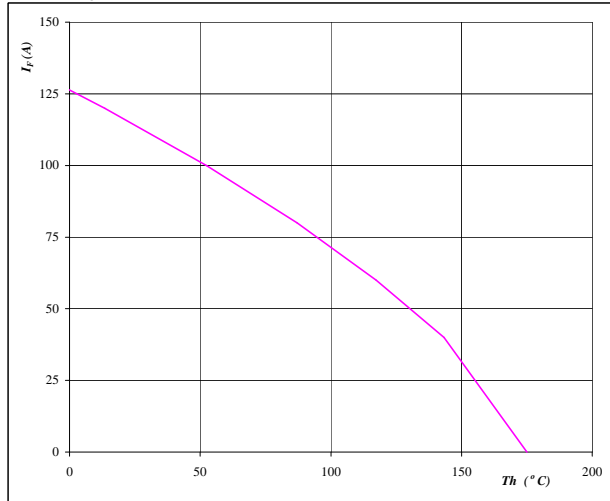

**At**  
T<sub>j</sub> = 175 °C



### Neutral Point

neutral point IGBT

**figure 25.** IGBT  
**Reverse bias safe operating area**

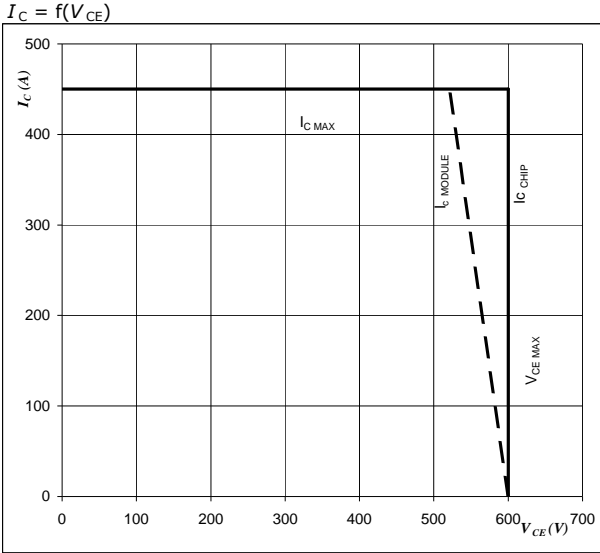

**At**  
 $T_j = T_{j\ max} - 25\ \text{°C}$   
 $U_{cc\ minus} = U_{cc\ plus}$   
 Switching mode : 3 level switching

**figure 26.** IGBT  
**Gate voltage vs Gate charge**

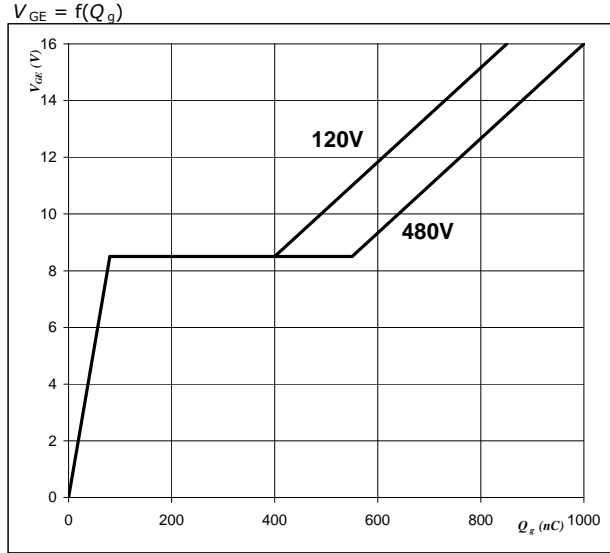

**At**  
 $I_D = 150\ \text{A}$   
 $T_j = 25\ \text{°C}$

**figure 27.** IGBT  
**Short circuit withstand time as a function of gate-emitter voltage**

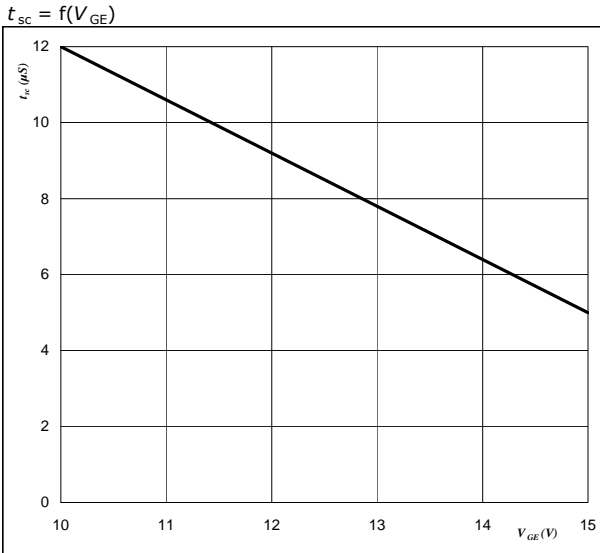

**At**  
 $V_{CE} \leq 400\ \text{V}$   
 $T_j \leq 150\ \text{°C}$

**figure 28.** IGBT  
**Typical short circuit collector current as a function of gate-emitter voltage**

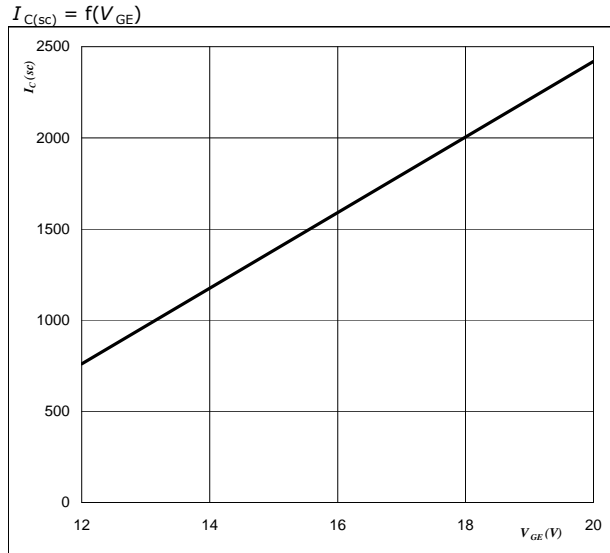

**At**  
 $V_{CE} \leq 400\ \text{V}$   
 $T_j = 150\ \text{°C}$



### Neutral Point IGBT Inverse Diode

figure 25. IGBT

Typical FWD forward current as a function of forward voltage

$$I_F = f(V_F)$$

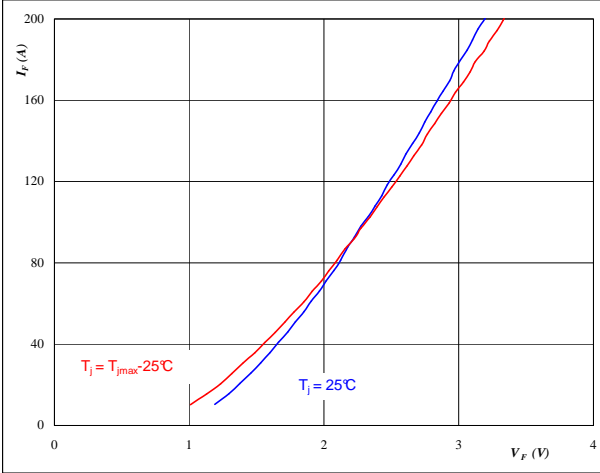

At  
 $t_p = 250 \mu s$

figure 26. IGBT

FWD transient thermal impedance as a function of pulse width

$$Z_{th(j-s)} = f(t_p)$$

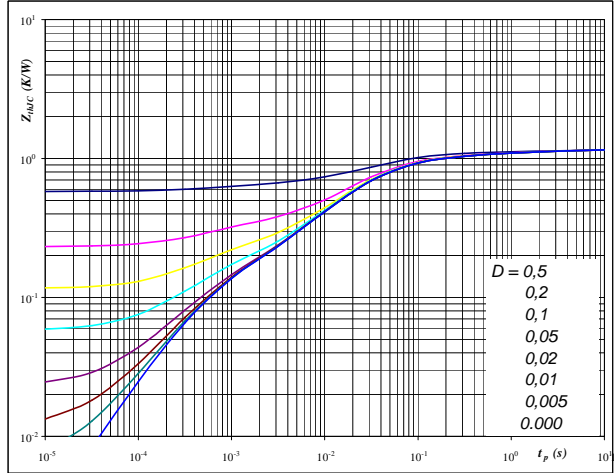

At  
 $D = t_p / T$   
 $R_{th(j-s)} = 1,16 \text{ K/W}$

figure 27. IGBT

Power dissipation as a function of heatsink temperature

$$P_{tot} = f(T_s)$$

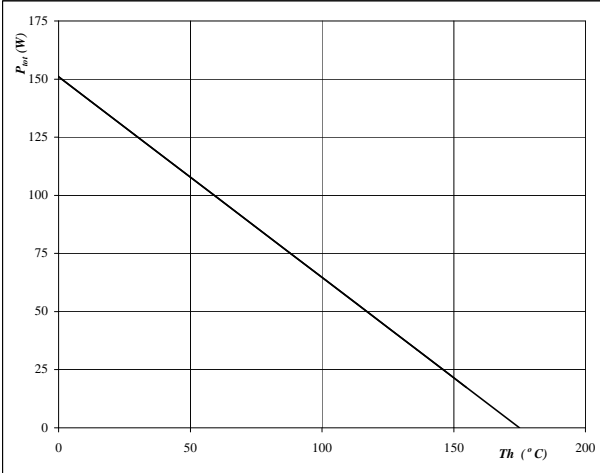

At  
 $T_j = 175 \text{ °C}$

figure 28. IGBT

Forward current as a function of heatsink temperature

$$I_F = f(T_s)$$

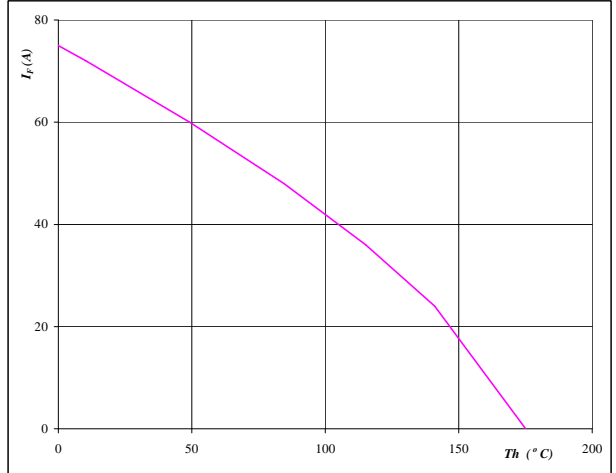

At  
 $T_j = 175 \text{ °C}$



### Half Bridge Inverse Diode

**figure 1.** IGBT

Typical FWD forward current as a function of forward voltage

$$I_F = f(V_F)$$

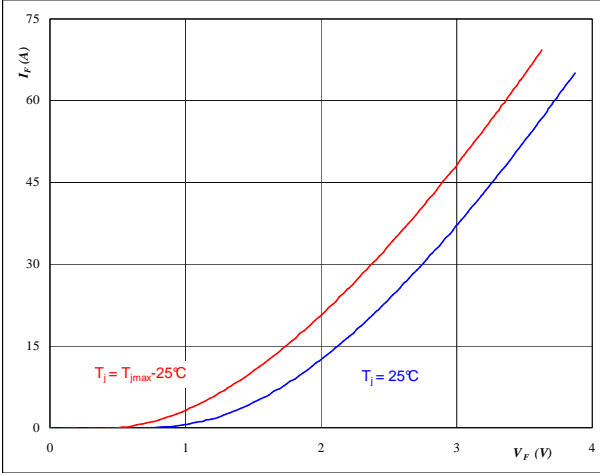

**At**  
 $t_p = 250 \mu s$

**figure 2.** IGBT

FWD transient thermal impedance as a function of pulse width

$$Z_{th(j-s)} = f(t_p)$$

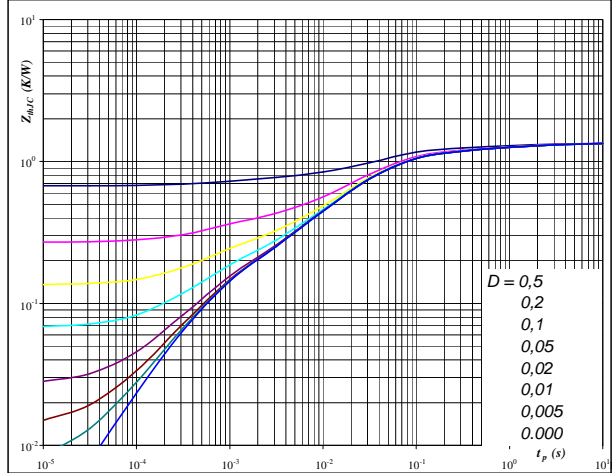

**At**  
 $D = t_p / T$   
 $R_{th(j-s)} = 1,35 \text{ K/W}$

**figure 3.** IGBT

Power dissipation as a function of heatsink temperature

$$P_{tot} = f(T_s)$$

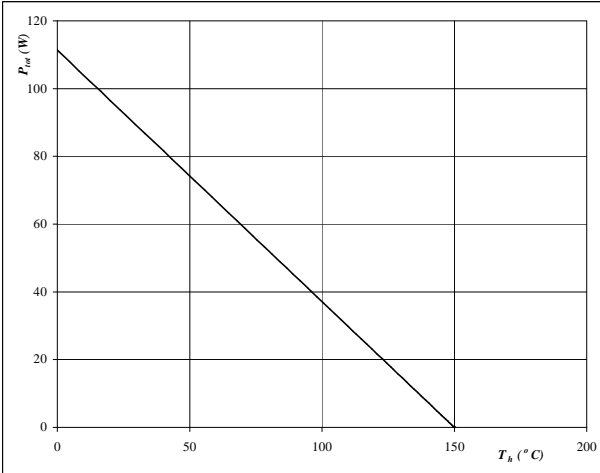

**At**  
 $T_j = 150 \text{ °C}$

**figure 4.** IGBT

Forward current as a function of heatsink temperature

$$I_F = f(T_s)$$

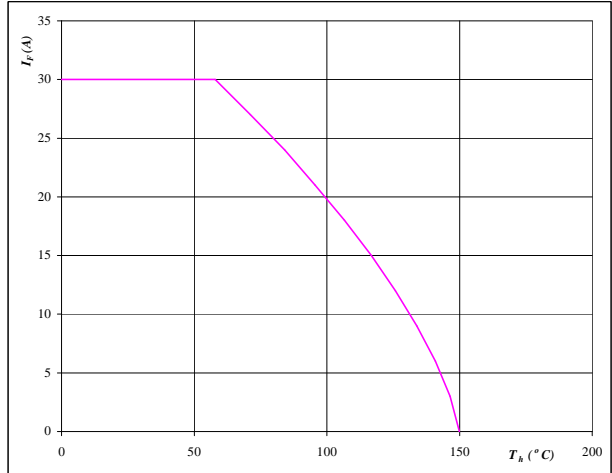

**At**  
 $T_j = 150 \text{ °C}$



## Thermistor

**figure 1. Thermistor**

**Typical NTC characteristic  
as a function of temperature**

$$R_T = f(T)$$

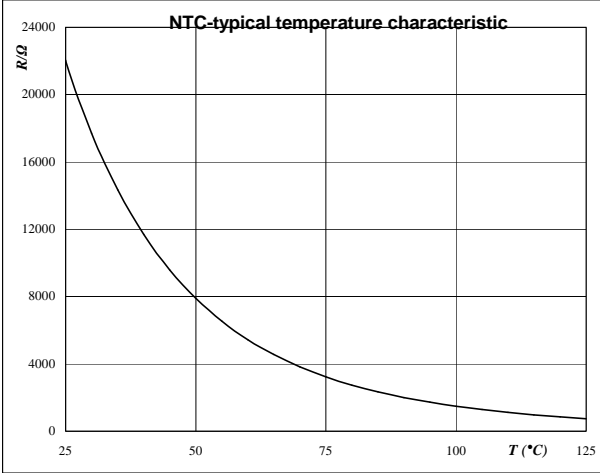



## Switching Definitions Half Bridge

**General conditions**

$T_j$	=	125 °C
$R_{gon}$	=	2 Ω
$R_{goff}$	=	2 Ω

**figure 1. IGBT**

**Turn-off Switching Waveforms & definition of  $t_{doff}$   $t_{Eoff}$**   
( $t_{Eoff}$  = integrating time for  $E_{off}$ )

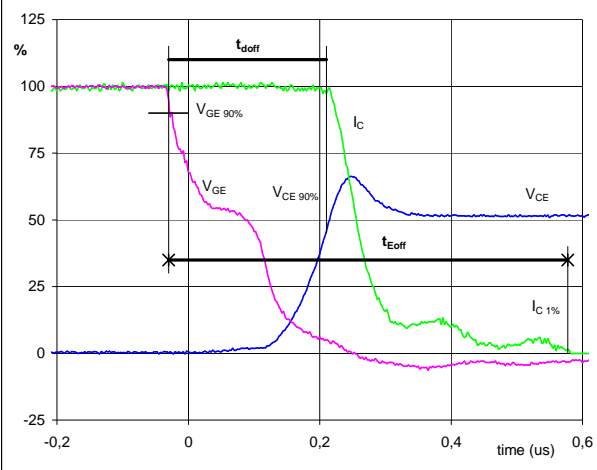

$V_{GE} (0\%) =$	-15	V
$V_{GE} (100\%) =$	15	V
$V_C (100\%) =$	700	V
$I_C (100\%) =$	198	A
$t_{doff} =$	0,23	μs
$t_{Eoff} =$	0,61	μs

**figure 2. IGBT**

**Turn-on Switching Waveforms & definition of  $t_{donr}$   $t_{Eon}$**   
( $t_{Eon}$  = integrating time for  $E_{on}$ )

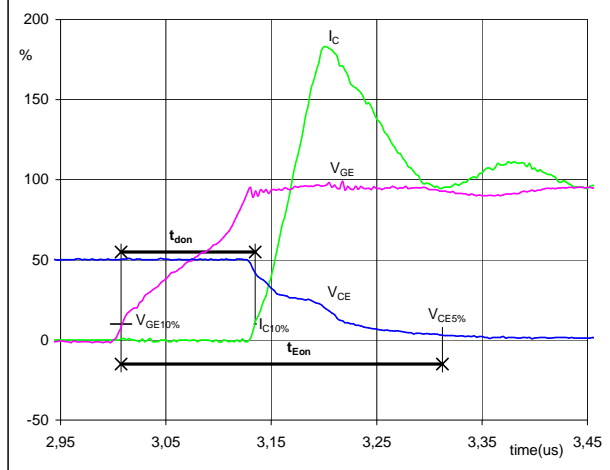

$V_{GE} (0\%) =$	-15	V
$V_{GE} (100\%) =$	15	V
$V_C (100\%) =$	700	V
$I_C (100\%) =$	198	A
$t_{donr} =$	0,13	μs
$t_{Eon} =$	0,30	μs

**figure 3. IGBT**

**Turn-off Switching Waveforms & definition of  $t_f$**

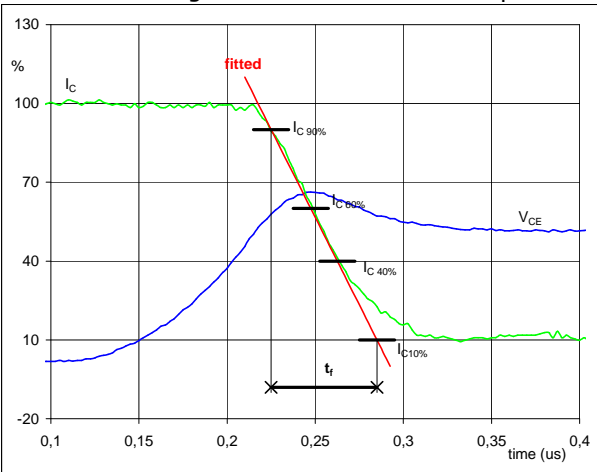

$V_C (100\%) =$	700	V
$I_C (100\%) =$	198	A
$t_f =$	0,06	μs

**figure 4. IGBT**

**Turn-on Switching Waveforms & definition of  $t_r$**

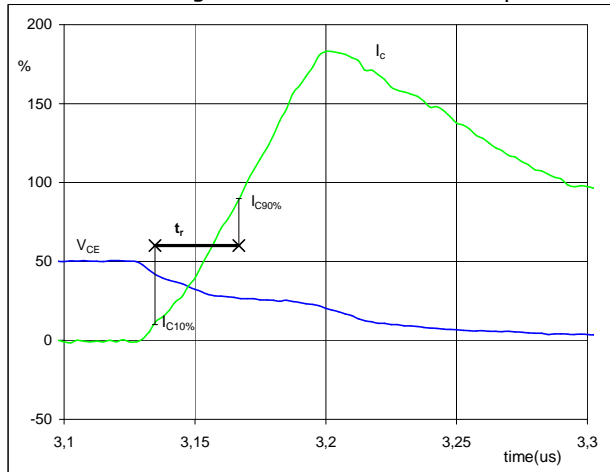

$V_C (100\%) =$	700	V
$I_C (100\%) =$	198	A
$t_r =$	0,03	μs





## Switching Definitions Half Bridge

**figure 5. IGBT**  
**Turn-off Switching Waveforms & definition of  $t_{Eoff}$**

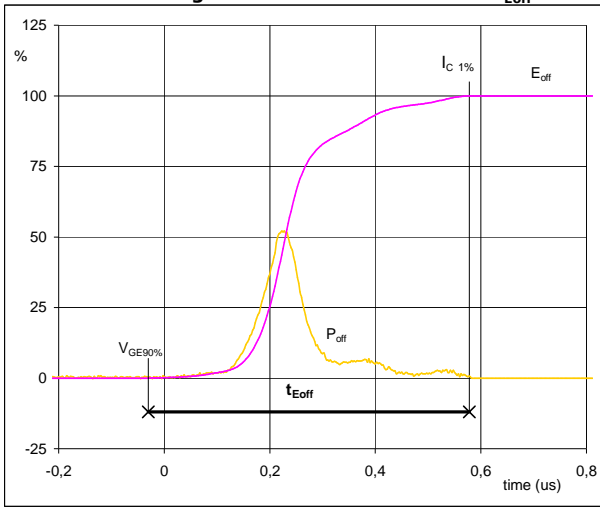

$P_{off} (100\%) = 138,85 \text{ kW}$   
 $E_{off} (100\%) = 7,97 \text{ mJ}$   
 $t_{Eoff} = 0,61 \text{ }\mu\text{s}$

**figure 6. IGBT**  
**Turn-on Switching Waveforms & definition of  $t_{Eon}$**

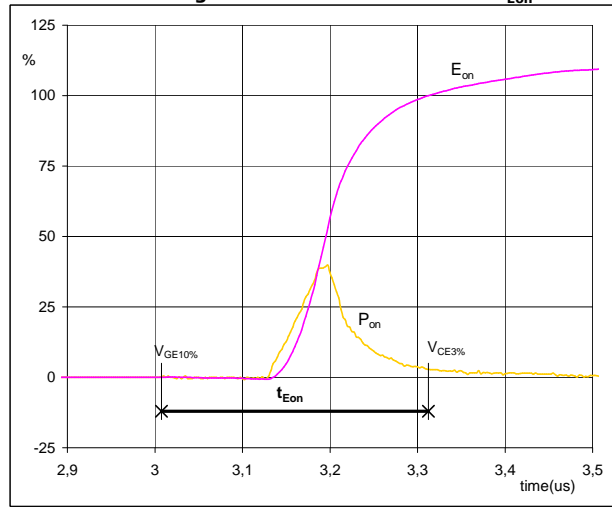

$P_{on} (100\%) = 138,85 \text{ kW}$   
 $E_{on} (100\%) = 4,20 \text{ mJ}$   
 $t_{Eon} = 0,30 \text{ }\mu\text{s}$

**figure 7. FWD**  
**Turn-off Switching Waveforms & definition of  $t_{rr}$**

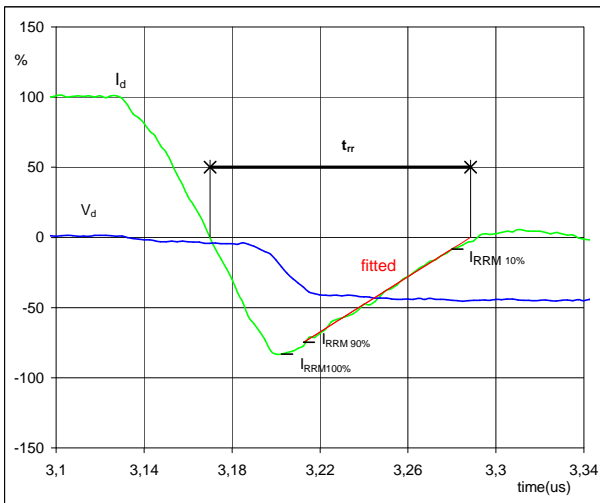

$V_d (100\%) = 700 \text{ V}$   
 $I_d (100\%) = 198 \text{ A}$   
 $I_{RRM} (100\%) = -169 \text{ A}$   
 $t_{rr} = 0,12 \text{ }\mu\text{s}$

**figure 8. FWD**  
**Turn-on Switching Waveforms & definition of  $t_{Qrr}$**   
**( $t_{Qrr} = \text{integrating time for } Q_{rr}$ )**

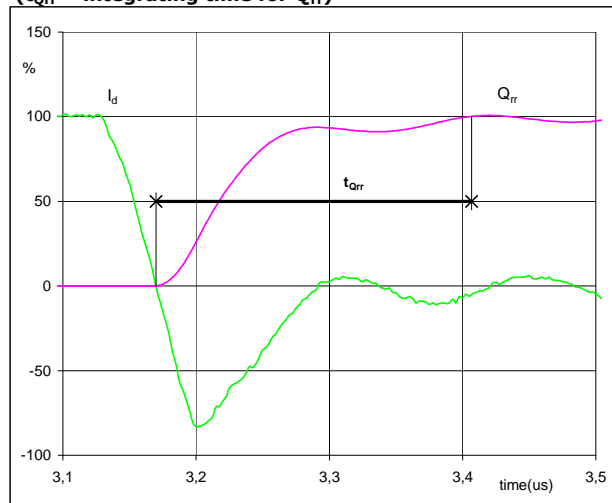

$I_d (100\%) = 198 \text{ A}$   
 $Q_{rr} (100\%) = 11,00 \text{ }\mu\text{C}$   
 $t_{Qrr} = 0,24 \text{ }\mu\text{s}$



### Switching Definitions Half Bridge

figure 9. FWD

Turn-on Switching Waveforms & definition of  $t_{Erec}$   
( $t_{Erec}$  = integrating time for  $E_{rec}$ )

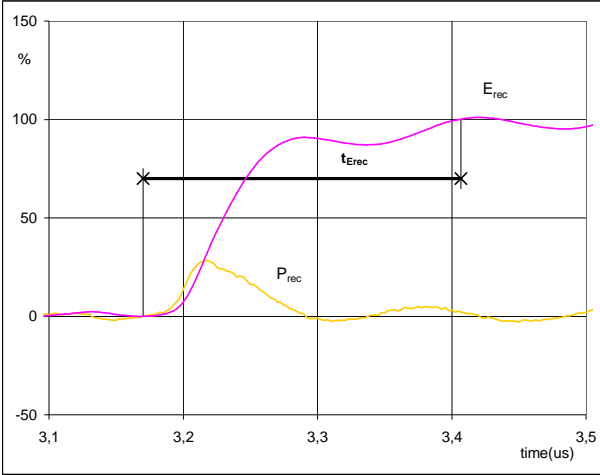

$P_{rec} (100\%) = 138,85 \text{ kW}$   
 $E_{rec} (100\%) = 2,39 \text{ mJ}$   
 $t_{Erec} = 0,24 \text{ }\mu\text{s}$

### Half Bridge switching measurement circuit

figure 11.

IGBT

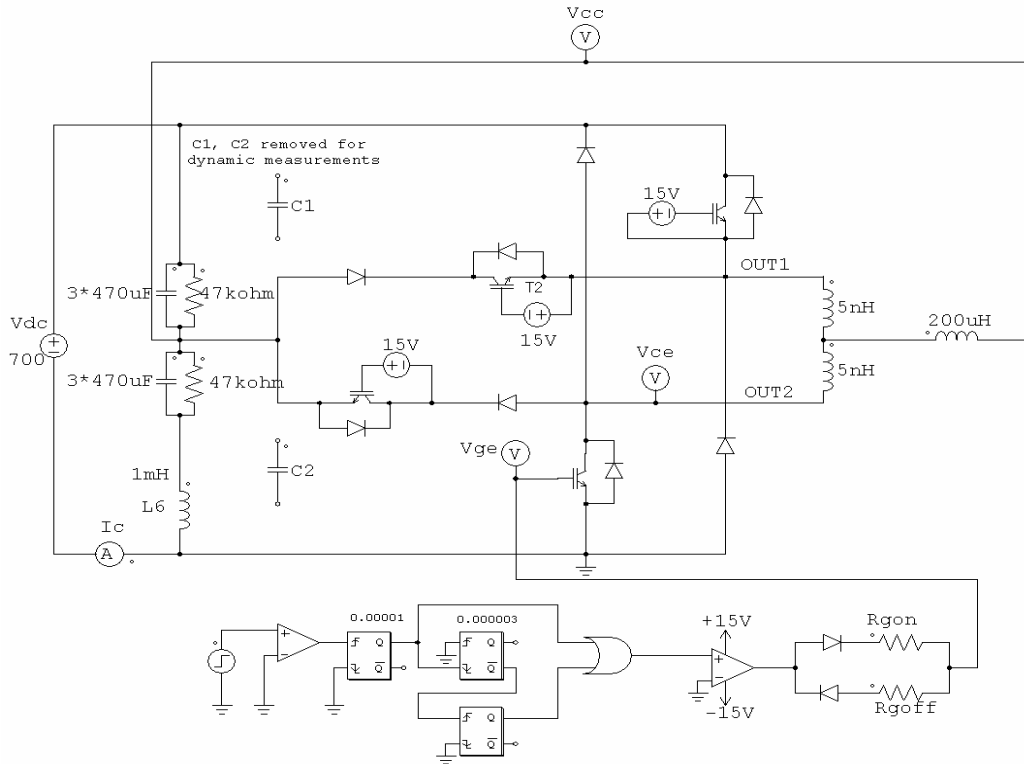



## Switching Definitions Neutral Point IGBT

**General conditions**

$T_j$	=	125 °C
$R_{gon}$	=	4 Ω
$R_{goff}$	=	4 Ω

**figure 1. Neutral Point IGBT**

**Turn-off Switching Waveforms & definition of  $t_{doff}$   $t_{Eoff}$**   
 ( $t_{Eoff}$  = integrating time for  $E_{off}$ )

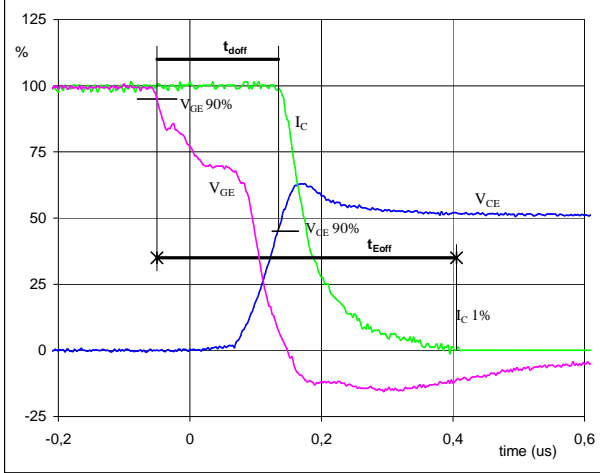

$V_{GE}$ (0%) =	-15	V
$V_{GE}$ (100%) =	15	V
$V_C$ (100%) =	700	V
$I_C$ (100%) =	151	A
$t_{doff}$ =	0,18	μs
$t_{Eoff}$ =	0,46	μs

**figure 2. Neutral Point IGBT**

**Turn-on Switching Waveforms & definition of  $t_{don}$   $t_{Eon}$**   
 ( $t_{Eon}$  = integrating time for  $E_{on}$ )

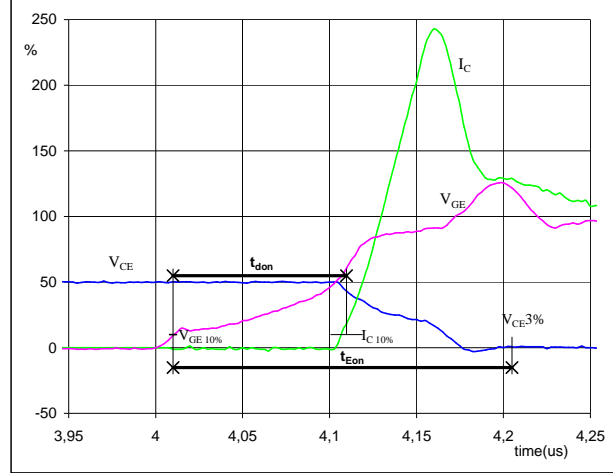

$V_{GE}$ (0%) =	-15	V
$V_{GE}$ (100%) =	15	V
$V_C$ (100%) =	700	V
$I_C$ (100%) =	151	A
$t_{don}$ =	0,11	μs
$t_{Eon}$ =	0,19	μs

**figure 3. Neutral Point IGBT**

**Turn-off Switching Waveforms & definition of  $t_f$**

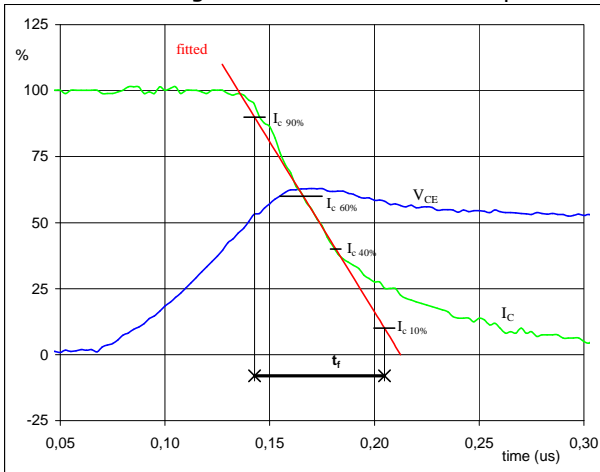

$V_C$ (100%) =	700	V
$I_C$ (100%) =	151	A
$t_f$ =	0,064	μs

**figure 4. Neutral Point IGBT**

**Turn-on Switching Waveforms & definition of  $t_r$**

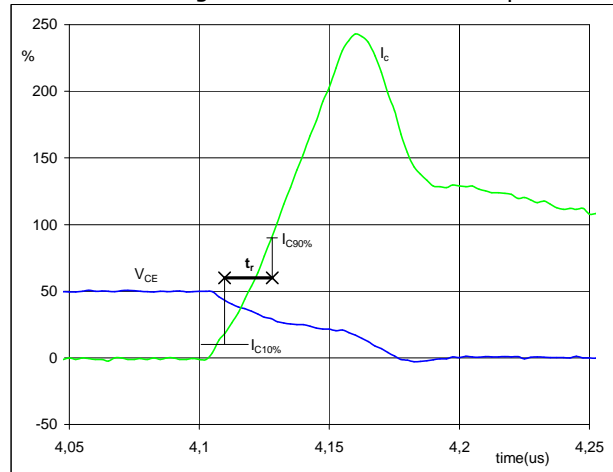

$V_C$ (100%) =	700	V
$I_C$ (100%) =	151	A
$t_r$ =	0,019	μs



## Switching Definitions Neutral Point IGBT

**figure 5. Neutral Point IGBT**  
**Turn-off Switching Waveforms & definition of  $t_{Eoff}$**

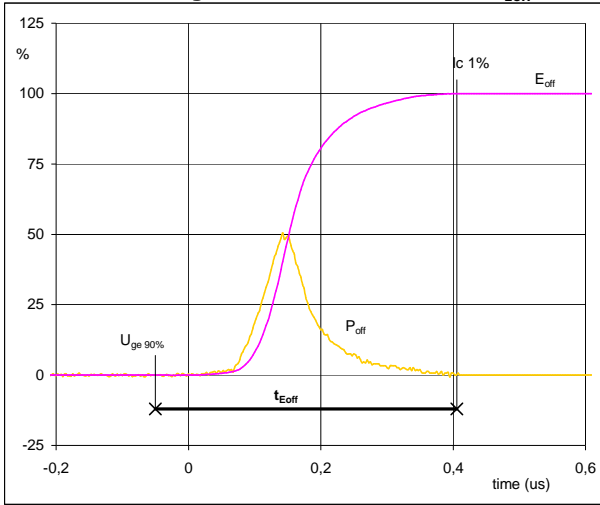

$P_{off} (100\%) = 69,93 \text{ kW}$   
 $E_{off} (100\%) = 3,32 \text{ mJ}$   
 $t_{Eoff} = 0,44 \text{ } \mu\text{s}$

**figure 6. Neutral Point IGBT**  
**Turn-on Switching Waveforms & definition of  $t_{Eon}$**

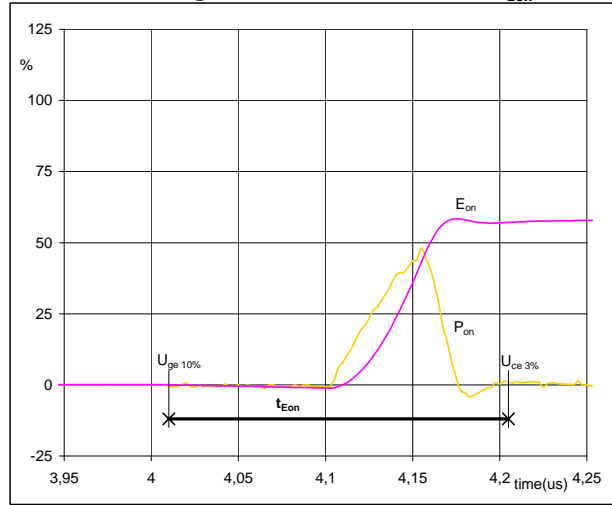

$P_{on} (100\%) = 69,93 \text{ kW}$   
 $E_{on} (100\%) = 1,52 \text{ mJ}$   
 $t_{Eon} = 0,18 \text{ } \mu\text{s}$

**figure 7. Half Bridge FWD**  
**Turn-off Switching Waveforms & definition of  $t_{rr}$**

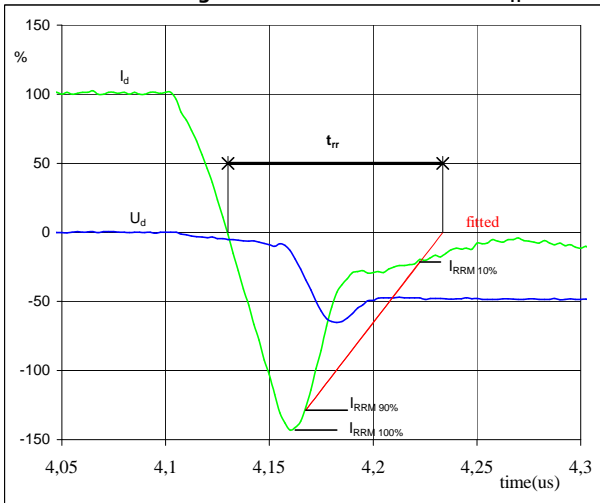

$V_d (100\%) = 700 \text{ V}$   
 $I_d (100\%) = 151 \text{ A}$   
 $I_{RRM} (100\%) = -142 \text{ A}$   
 $t_{rr} = 0,07 \text{ } \mu\text{s}$

**figure 8. Half Bridge FWD**  
**Turn-on Switching Waveforms & definition of  $t_{Qrr}$**

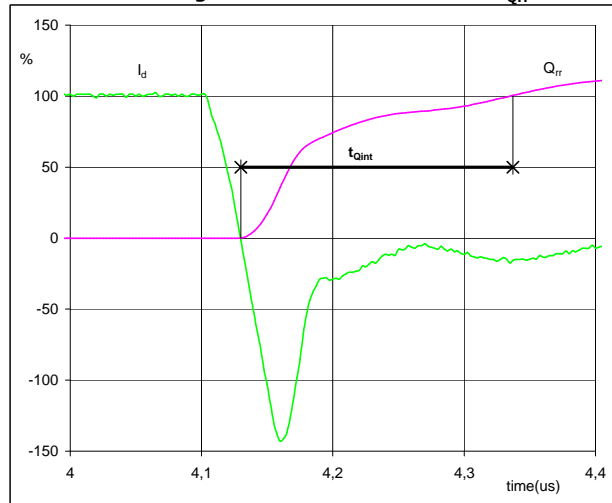

$I_d (100\%) = 151 \text{ A}$   
 $Q_{rr} (100\%) = 12,71 \text{ } \mu\text{C}$   
 $t_{Qrr} = 1,00 \text{ } \mu\text{s}$



### Switching Definitions Neutral Point IGBT

figure 9. Half Bridge FWD

Turn-on Switching Waveforms & definition of  $t_{Erec}$   
( $t_{Erec}$  = integrating time for  $E_{rec}$ )

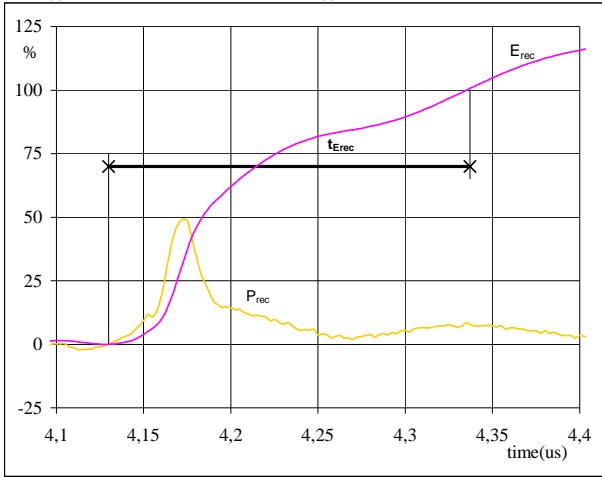

$P_{rec}$ (100%) =	69,93	kW
$E_{rec}$ (100%) =	3,61	mJ
$t_{Erec}$ =	1,00	μs

### Neutral Point IGBT switching measurement circuit

figure 10.

Neutral Point IGBT

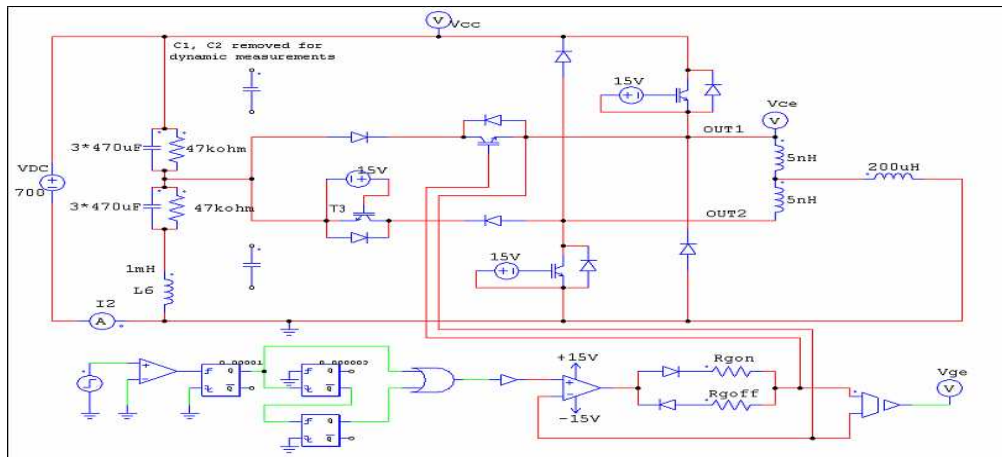



**Ordering Code and Marking - Outline - Pinout**

**Ordering Code & Marking**

Version	Ordering Code	in DataMatrix as	in packaging barcode as
without thermal paste with solder pins	30-FT12NMA200SH-M660F08	M660F08	M660F08
with thermal paste and solder pins	30-FT12NMA200SH-M660F08-/3/	M660F08	M660F08-/3/
without thermal paste with Press-fit pins	30-PT12NMA200SH-M660F08Y	M660F08Y	M660F08Y
with thermal paste and Press-fit pins	30-PT12NMA200SH-M660F08Y-/3/	M660F08Y	M660F08Y-/3/

**Outline**

Pin table			Pin table		
Pin	X	Y	Pin	X	Y
1	70	3	27	5	3
2	70	0	28	5	0
3	67,5	0	29	2,5	3
4	65	0	30	2,5	0
5	62,5	0	31	0	3
6	60	0	32	0	0
7	52,75	3	33	5,75	19,45
8	52,75	0	34	5,75	22,45
9	50,25	3	35	12,1	22,7
10	50,25	0	36	19,25	22,85
11	43	3	37	17,85	19,85
12	43	0	38	2	36
13	40,5	3	39	4,5	36
14	40,5	0	40	7	36
15	38	3	41	9,5	36
16	38	0	42	12	36
17	32	3	43	14,5	36
18	32	0	44	38	36
19	29,5	3	45	40,5	36
20	29,5	0	46	43	36
21	27	3	47	45,5	36
22	27	0	48	48	36
23	19,75	0	49	50,5	36
24	17,25	0	50	49,9	32
25	14,75	0	51	52,9	32
26	12,25	0	52	52	18,1

Pin	X	Y
53	64,2	36,6
54	70,6	36,55
55	70	18,9
56	68,55	15,9

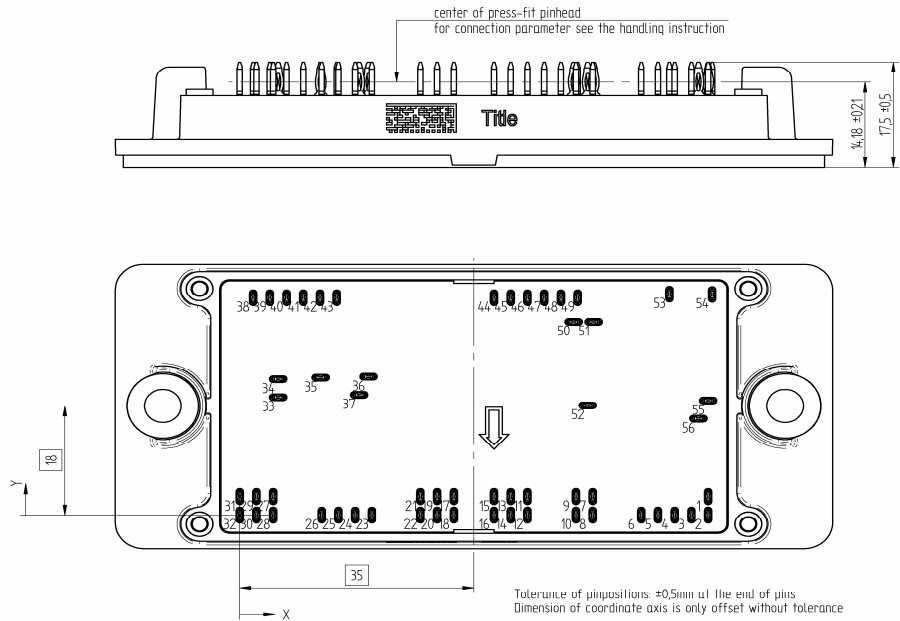

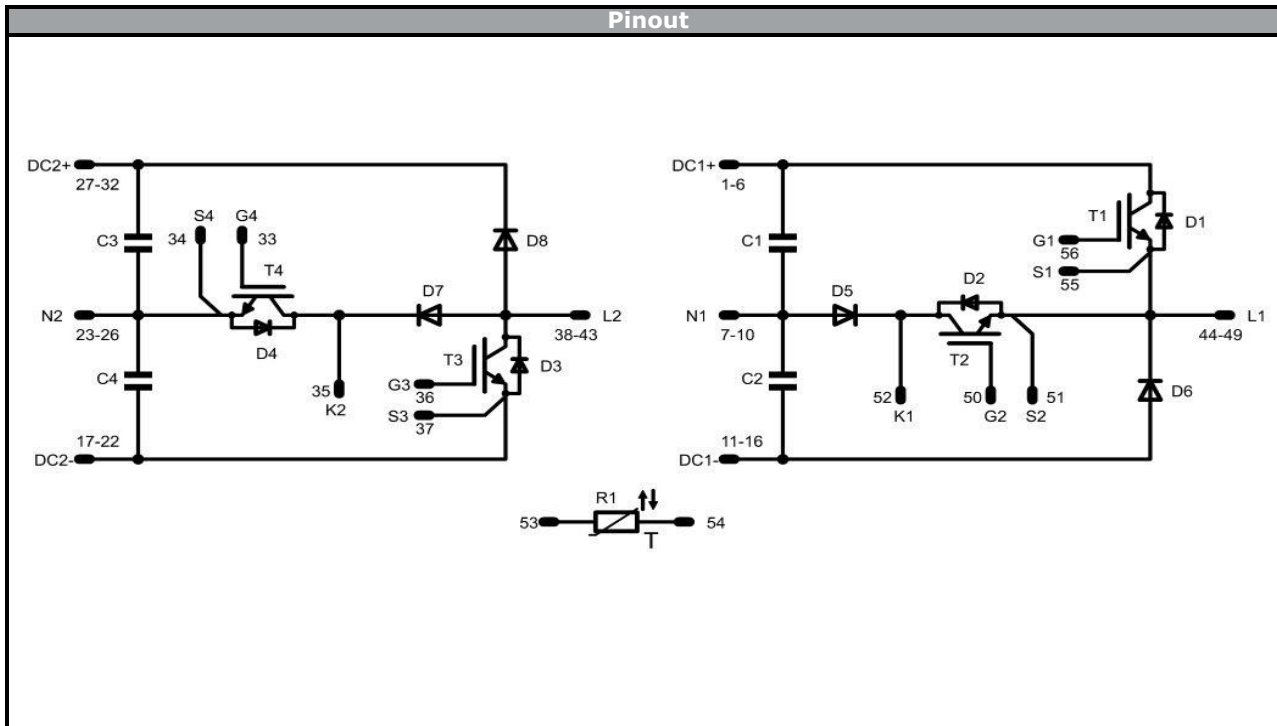

<b>Identification</b>					
<b>ID</b>	<b>Component</b>	<b>Voltage</b>	<b>Current</b>	<b>Function</b>	<b>Comment</b>
T1, T3	IGBT	1200V	200A	Half Bridge IGBT	
D1, D3	FWD	1200V	15A	HB IGBT Inverse Diode	
D5, D7	FWD	700V	150A	Neutral Point FWD	
T2, T4	IGBT	600V	150A	Neutral Point IGBT	
D6, D8	FWD	1200V	100A	Half Bridge FWD	
D2, D4	FWD	600V	50A	NP IGBT Inverse Diode	
R1	Resistor			Resistor	

**Packaging instruction**

Standard packaging quantity (SPQ)	<b>36</b>	>SPQ	Standard	<SPQ	Sample
-----------------------------------	-----------	------	----------	------	--------

**Handling instruction**

Handling instructions for *flow 2* packages see vincotech.com website.

**Package data**

Package data for *flow 2* packages see vincotech.com website.

**UL recognition and file number**

This device is certified according to UL 1557 standard, UL file number E192116. For more information see vincotech.com website.



<b>Document No.:</b>	<b>Date:</b>	<b>Modification:</b>	<b>Pages</b>
30-FT12NMA200SH-M660F08-D3-14	19 Mar. 2018	Pin number corrected on schematic	31

**DISCLAIMER**

The information, specifications, procedures, methods and recommendations herein (together "information") are presented by Vincotech to reader in good faith, are believed to be accurate and reliable, but may well be incomplete and/or not applicable to all conditions or situations that may exist or occur. Vincotech reserves the right to make any changes without further notice to any products to improve reliability, function or design. No representation, guarantee or warranty is made to reader as to the accuracy, reliability or completeness of said information or that the application or use of any of the same will avoid hazards, accidents, losses, damages or injury of any kind to persons or property or that the same will not infringe third parties rights or give desired results. It is reader's sole responsibility to test and determine the suitability of the information and the product for reader's intended use.

**LIFE SUPPORT POLICY**

Vincotech products are not authorised for use as critical components in life support devices or systems without the express written approval of Vincotech.

As used herein:

1. Life support devices or systems are devices or systems which, (a) are intended for surgical implant into the body, or (b) support or sustain life, or (c) whose failure to perform when properly used in accordance with instructions for use provided in labelling can be reasonably expected to result in significant injury to the user.
2. A critical component is any component of a life support device or system whose failure to perform can be reasonably expected to cause the failure of the life support device or system, or to affect its safety or effectiveness.



单击下面可查看定价，库存，交付和生命周期等信息

[>>Vincotech\(威科\)](#)