

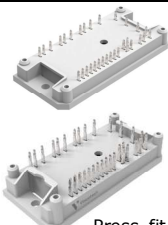
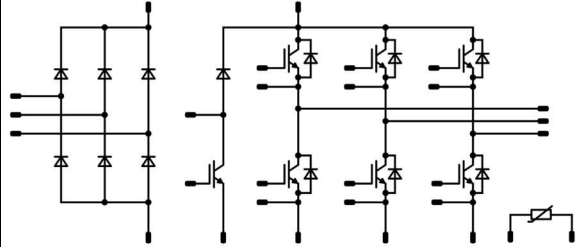

Vincotech

10-FY12PMA035M7-P589A78
10-PY12PMA035M7-P589A78Y
10-F112PMA035M7-P589A79
10-P112PMA035M7-P589A79Y
 datasheet

flow PIM 1	1200 V / 35 A
<div style="background-color: #eee; padding: 5px; margin-bottom: 5px;">Features</div> <ul style="list-style-type: none"> IGBT M7 with low V_{CEsat} and improved EMC behavior Open emitter configuration Compact and low inductive design Built-in NTC 	<div style="background-color: #eee; padding: 5px; margin-bottom: 5px;">flow 1 housing</div> <div style="display: flex; justify-content: space-around;"> <div style="text-align: center;"> <p>12 mm housing</p>  <p>Solder pins</p> </div> <div style="text-align: center;"> <p>17 mm housing</p>  <p>Press-fit pins</p> </div> </div>
<div style="background-color: #eee; padding: 5px; margin-bottom: 5px;">Target applications</div> <ul style="list-style-type: none"> Industrial Drives 	<div style="background-color: #eee; padding: 5px; margin-bottom: 5px;">Schematic</div> 
<div style="background-color: #eee; padding: 5px; margin-bottom: 5px;">Types</div> <ul style="list-style-type: none"> 10-FY12PMA035M7-P589A78 10-PY12PMA035M7-P589A78Y 10-F112PMA035M7-P589A79 10-P112PMA035M7-P589A79Y 	

Maximum Ratings

$T_j = 25\text{ }^\circ\text{C}$, unless otherwise specified

Parameter	Symbol	Condition	Value	Unit
Rectifier Diode				
Peak Repetitive Reverse Voltage	V_{RRM}		1600	V
Continuous (direct) forward current	I_F	$T_j = T_{jmax}$ $T_s = 80\text{ }^\circ\text{C}$	55	A
Surge (non-repetitive) forward current	I_{FSM}	50 Hz Single Half Sine Wave $t_p = 10\text{ ms}$ $T_j = 150\text{ }^\circ\text{C}$	350	A
Surge current capability	I^2t		610	A ² s
Total power dissipation	P_{tot}	$T_j = T_{jmax}$ $T_s = 80\text{ }^\circ\text{C}$	65	W
Maximum Junction Temperature	T_{jmax}		150	$^\circ\text{C}$



Vincotech

10-FY12PMA035M7-P589A78
10-PY12PMA035M7-P589A78Y
10-F112PMA035M7-P589A79
10-P112PMA035M7-P589A79Y
 datasheet

Maximum Ratings

$T_j = 25\text{ °C}$, unless otherwise specified

Parameter	Symbol	Condition	Value	Unit
-----------	--------	-----------	-------	------

Inverter Switch

Collector-emitter voltage	V_{CES}		1200	V
Collector current	I_C	$T_j = T_{jmax}$ $T_s = 80\text{ °C}$	50	A
Repetitive peak collector current	I_{CRM}	t_p limited by T_{jmax}	70	A
Total power dissipation	P_{tot}	$T_j = T_{jmax}$ $T_s = 80\text{ °C}$	107	W
Gate-emitter voltage	V_{GES}		± 20	V
Short circuit ratings	t_{SC}	$V_{GE} = 15\text{ V}$ $V_{ce} = 800\text{ V}$ $T_j = 150\text{ °C}$	9,5	μs
Maximum junction temperature	T_{jmax}		175	$^{\circ}C$

Inverter Diode

Peak repetitive reverse voltage	V_{RRM}		1200	V
Continuous (direct) forward current	I_F	$T_j = T_{jmax}$ $T_s = 80\text{ °C}$	40	A
Repetitive peak forward current	I_{FRM}	T_j limited by T_{jmax}	70	A
Total power dissipation	P_{tot}	$T_j = T_{jmax}$ $T_s = 80\text{ °C}$	75	W
Maximum junction temperature	T_{jmax}		175	$^{\circ}C$

Brake Switch

Collector-emitter voltage	V_{CES}		1200	V
Collector current	I_C	$T_j = T_{jmax}$ $T_s = 80\text{ °C}$	34	A
Repetitive peak collector current	I_{CRM}	t_p limited by T_{jmax}	50	A
Total power dissipation	P_{tot}	$T_j = T_{jmax}$ $T_s = 80\text{ °C}$	82	W
Gate-emitter voltage	V_{GES}		± 20	V
Short circuit ratings	t_{SC}	$V_{GE} = 15\text{ V}$ $V_{ce} = 800\text{ V}$ $T_j = 150\text{ °C}$	9,5	μs
Maximum junction temperature	T_{jmax}		175	$^{\circ}C$

Brake Diode

Peak repetitive reverse voltage	V_{RRM}		1200	V
Continuous (direct) forward current	I_F	$T_j = T_{jmax}$ $T_s = 80\text{ °C}$	21	A
Repetitive peak forward current	I_{FRM}	T_j limited by T_{jmax}	30	A
Total power dissipation	P_{tot}	$T_j = T_{jmax}$ $T_s = 80\text{ °C}$	45	W
Maximum junction temperature	T_{jmax}		175	$^{\circ}C$



Vincotech

10-FY12PMA035M7-P589A78
10-PY12PMA035M7-P589A78Y
10-F112PMA035M7-P589A79
10-P112PMA035M7-P589A79Y
 datasheet

Maximum Ratings

$T_j = 25\text{ °C}$, unless otherwise specified

Parameter	Symbol	Condition	Value	Unit
-----------	--------	-----------	-------	------

Module Properties

Thermal Properties

Storage temperature	T_{stg}		-40...+125	°C
Operation temperature under switching condition	T_{top}		-40...(T _{jmax} - 25)	°C

Isolation Properties

Isolation voltage	V_{isol}	DC Test Voltage* $t_p = 2\text{ s}$	6000	V
		AC Voltage $t_p = 1\text{ min}$	2500	V
Creepage distance			min. 12,7	mm
Clearance		12 mm housing with solder pins / press-fit pins	7,91 / 7,96	mm
		17 mm housing	min. 12,7	
Comparative Tracking Index	CTI		> 200	

*100 % tested in production



Vincotech

10-FY12PMA035M7-P589A78
10-PY12PMA035M7-P589A78Y
10-F112PMA035M7-P589A79
10-P112PMA035M7-P589A79Y
 datasheet

Characteristic Values

Parameter	Symbol	Conditions					Value			Unit
		V_{GE} [V]	V_{CE} [V]	I_C [A]	T_j [°C]	Min	Typ	Max		

Rectifier Diode

Static

Parameter	Symbol	V_{GS} [V]	V_{DS} [V]	I_D [A]	T_j [°C]	Min	Typ	Max	Unit
Forward voltage	V_F			45	25 125 150		1,15 1,12 1,15	1,6	V
Reverse leakage current	I_r		1600		25 145			50 1100	µA

Thermal

Parameter	Symbol	Conditions	Value	Unit
Thermal resistance junction to sink	$R_{th(j-s)}$	$\lambda_{paste} = 3,4$ W/mK (PSX)	1,08	K/W



Vincotech

10-FY12PMA035M7-P589A78
10-PY12PMA035M7-P589A78Y
10-F112PMA035M7-P589A79
10-P112PMA035M7-P589A79Y
 datasheet

Characteristic Values

Parameter	Symbol	Conditions					Value			Unit
		V_{GS} [V]	V_{GE} [V]	V_{DS} [V]	I_D [A]	T_j [°C]	Min	Typ	Max	

Inverter Switch

Static

Parameter	Symbol	Conditions	V_{GS} [V]	V_{GE} [V]	V_{DS} [V]	I_D [A]	T_j [°C]	Min	Typ	Max	Unit
Gate-emitter threshold voltage	$V_{GE(th)}$	$V_{GE} = V_{CE}$				0,0035	25	5,4	6	6,6	V
Collector-emitter saturation voltage	V_{CEsat}		15			35	25 125 150		1,48 1,64 1,68	1,75	V
Collector-emitter cut-off current	I_{CES}		0	1200			25			0,08	mA
Gate-emitter leakage current	I_{GES}		20	0			25			0,5	μA
Internal gate resistance	r_g								none		Ω
Input capacitance	C_{ies}								8000		pF
Output capacitance	C_{oes}		0	10		25			280		
Reverse transfer capacitance	C_{res}								95		
Gate charge	Q_g		15	600	35		25		300		nC

Thermal

Parameter	Symbol	Conditions	V_{GS} [V]	V_{GE} [V]	V_{DS} [V]	I_D [A]	T_j [°C]	Min	Typ	Max	Unit
Thermal resistance junction to sink	$R_{th(j-s)}$	$\lambda_{paste} = 3,4$ W/mK (PSX)							0,89		K/W

Dynamic

Parameter	Symbol	Conditions	V_{GS} [V]	V_{GE} [V]	V_{DS} [V]	I_D [A]	T_j [°C]	Min	Typ	Max	Unit
Turn-on delay time	$t_{d(on)}$	$R_{goff} = 8 \Omega$ $R_{gon} = 8 \Omega$	±15	600	35		25		124		ns
Rise time	t_r							125	122		
Turn-off delay time	$t_{d(off)}$							150	121		
Fall time	t_f							25	14		
Turn-on energy (per pulse)	E_{on}							125	17		
Turn-off energy (per pulse)	E_{off}	150	18								
		25	179								
		125	203								
		150	208								
		25	95								
		125	118								
		150	119								
		25	1,45								
		125	1,92								
		150	2,09								
		25	2,40								
		125	3,17								
		150	3,42								



Vincotech

10-FY12PMA035M7-P589A78
10-PY12PMA035M7-P589A78Y
10-F112PMA035M7-P589A79
10-P112PMA035M7-P589A79Y
 datasheet

Characteristic Values

Parameter	Symbol	Conditions					Value			Unit
		V_{GE} [V] V_{GS} [V]	V_{CE} [V] V_{DS} [V] V_F [V]	I_C [A] I_D [A] I_F [A]	T_j [°C]	Min	Typ	Max		

Inverter Diode

Static

Forward voltage	V_F				35	25 125 150		1,66 1,76 1,75	2,1	V
Reverse leakage current	I_R			1200		25			40	μA

Thermal

Thermal resistance junction to sink	$R_{th(j-s)}$	$\lambda_{paste} = 3,4$ W/mK (PSX)						1,27		K/W
-------------------------------------	---------------	---------------------------------------	--	--	--	--	--	------	--	-----

Dynamic

Peak recovery current	I_{RRM}					25 125 150		77 76 77		A
Reverse recovery time	t_{rr}					25 125 150		157 284 311		ns
Recovered charge	Q_r	$di/dt = 2681$ A/μs $di/dt = 2670$ A/μs $di/dt = 2690$ A/μs	±15	600	35	25 125 150		4,34 6,18 6,90		μC
Reverse recovered energy	E_{rec}					25 125 150		1,96 2,82 3,13		mWs
Peak rate of fall of recovery current	$(di_{rr}/dt)_{max}$					25 125 150		2734 2205 2101		A/μs



Vincotech

10-FY12PMA035M7-P589A78
10-PY12PMA035M7-P589A78Y
10-F112PMA035M7-P589A79
10-P112PMA035M7-P589A79Y
 datasheet

Characteristic Values

Parameter	Symbol	Conditions					Value			Unit
		V_{GS} [V]	V_{GE} [V]	V_{DS} [V]	I_D [A]	T_j [°C]	Min	Typ	Max	

Brake Switch

Static

Parameter	Symbol	$V_{GE} = V_{CE}$	V_{GS} [V]	V_{CE} [V]	I_D [A]	T_j [°C]	Min	Typ	Max	Unit
Gate-emitter threshold voltage	$V_{GE(th)}$				0,0025	25	5,4	6	6,6	V
Collector-emitter saturation voltage	V_{CEsat}		15		25	25 125 150		1,65 1,89 1,95	1,95	V
Collector-emitter cut-off current	I_{CES}		0	1200		25			70	µA
Gate-emitter leakage current	I_{GES}		20	0		25			500	nA
Internal gate resistance	r_g							none		Ω
Input capacitance	C_{ies}							4800		pF
Output capacitance	C_{oes}		0	10		25		170		
Reverse transfer capacitance	C_{res}							57		
Gate charge	Q_g		15	600	25	25		180		nC

Thermal

Parameter	Symbol	$\lambda_{paste} = 3,4$ W/mK (PSX)	$R_{th(j-s)}$	Min	Typ	Max	Unit
Thermal resistance junction to sink	$R_{th(j-s)}$				1,16		K/W

Dynamic

Parameter	Symbol	$R_{goff} = 16$ Ω $R_{gon} = 16$ Ω	V_{GS} [V]	V_{CE} [V]	I_D [A]	T_j [°C]	Min	Typ	Max	Unit
Turn-on delay time	$t_{d(on)}$					25 125 150		71 67 65		ns
Rise time	t_r					25 125 150		48 50 51		
Turn-off delay time	$t_{d(off)}$					25 125 150		262 290 296		
Fall time	t_f					25 125 150		101 117 119		
Turn-on energy (per pulse)	E_{on}	$Q_{tFWD} = 1,9$ µC $Q_{tFWD} = 2,9$ µC $Q_{tFWD} = 3,2$ µC				25 125 150		2,60 3,11 3,24		mWs
Turn-off energy (per pulse)	E_{off}					25 125 150		2,03 2,65 2,81		



Vincotech

10-FY12PMA035M7-P589A78
10-PY12PMA035M7-P589A78Y
10-F112PMA035M7-P589A79
10-P112PMA035M7-P589A79Y
 datasheet

Characteristic Values

Parameter	Symbol	Conditions					Value			Unit
		V_{GE} [V]	V_{CE} [V]	I_C [A]	T_j [°C]	Min	Typ	Max		

Brake Diode

Static

Parameter	Symbol	V_{GE} [V]	V_{CE} [V]	I_C [A]	T_j [°C]	Min	Typ	Max	Unit
Forward voltage	V_F			15	25 125 150		1,63 1,74 1,73	2,1	V
Reverse leakage current	I_R		1200		25			30	μA

Thermal

Parameter	Symbol	Conditions	Value	Unit
Thermal resistance junction to sink	$R_{th(j-s)}$	$\lambda_{paste} = 3,4$ W/mK (PSX)	2,11	K/W

Dynamic

Parameter	Symbol	V_{GE} [V]	V_{CE} [V]	I_C [A]	T_j [°C]	Min	Typ	Max	Unit
Peak recovery current	I_{RRM}				25 125 150		14 15 15		A
Reverse recovery time	t_{rr}				25 125 150		264 375 413		ns
Recovered charge	Q_r		15/0	700	25		1,92 2,90 3,15		μC
Reverse recovered energy	E_{rec}				25 125 150		0,78 1,28 1,41		mWs
Peak rate of fall of recovery current	$(di_{rr}/dt)_{max}$				25 125 150		111 85 72		A/μs

Thermistor

Parameter	Symbol	Conditions	Value	Unit
Rated resistance	R		25	kΩ
Deviation of R_{100}	$\Delta_{R/R}$	$R_{100} = 1484$ Ω	100	%
Power dissipation	P		25	mW
Power dissipation constant			25	mW/K
B-value	$B_{(25/50)}$	Tol. ±1 %	25	K
B-value	$B_{(25/100)}$	Tol. ±1 %	25	K
Vincotech NTC Reference				I



Rectifier Diode Characteristics

figure 1. Rectifier Diode

Typical forward characteristics

$I_F = f(V_F)$

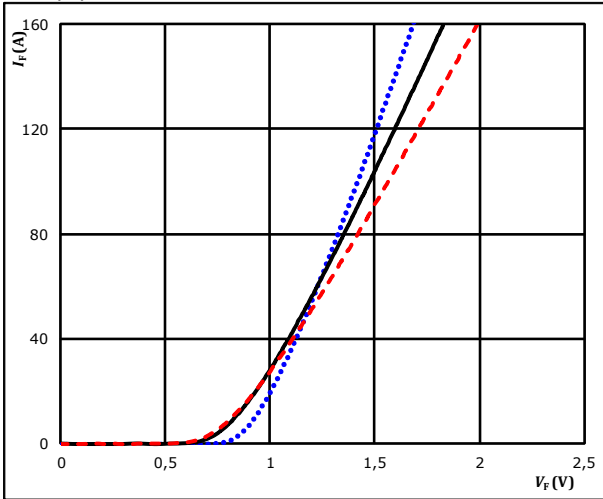

$t_p = 250 \mu s$

T_j : 25 °C (dotted blue line)
 125 °C (solid black line)
 150 °C (dashed red line)

figure 2. Rectifier Diode

Transient thermal impedance as a function of pulse width

$Z_{th(j-s)} = f(t_p)$

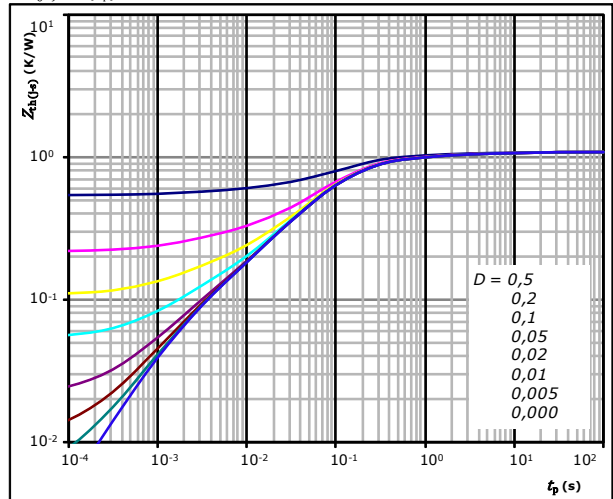

$D = t_p / T$

$R_{th(j-s)} = 1,08 \text{ K/W}$

Diode thermal model values

R (K/W)	τ (s)
4,60E-02	9,93E+00
1,23E-01	1,00E+00
4,58E-01	1,51E-01
3,31E-01	5,61E-02
7,76E-02	9,34E-03
4,64E-02	1,55E-03



Inverter Switch Characteristics

figure 1. IGBT

Typical output characteristics

$I_C = f(V_{CE})$

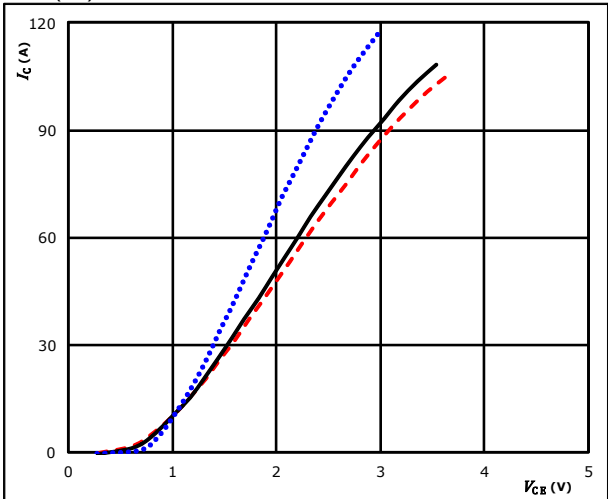

$t_p = 250 \mu s$ $T_j: 25 \text{ }^\circ C$
 $V_{GE} = 15 \text{ V}$ $T_j: 125 \text{ }^\circ C$ ———
 $T_j: 150 \text{ }^\circ C$ - - - -

figure 2. IGBT

Typical output characteristics

$I_C = f(V_{CE})$

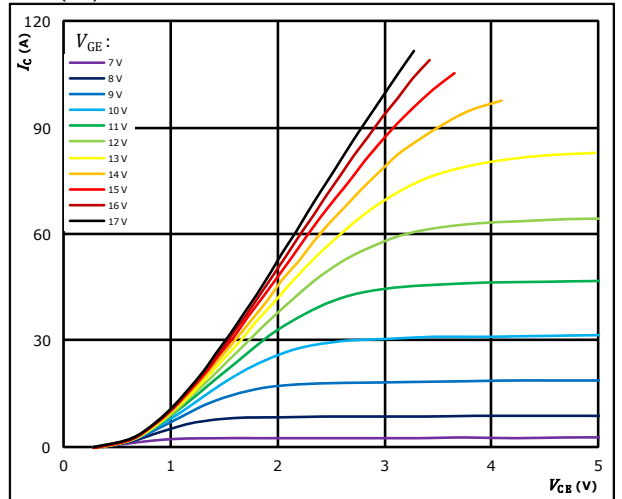

$t_p = 250 \mu s$
 $T_j = 150 \text{ }^\circ C$
 V_{GE} from 7 V to 17 V in steps of 1 V

figure 3. IGBT

Typical transfer characteristics

$I_C = f(V_{GE})$

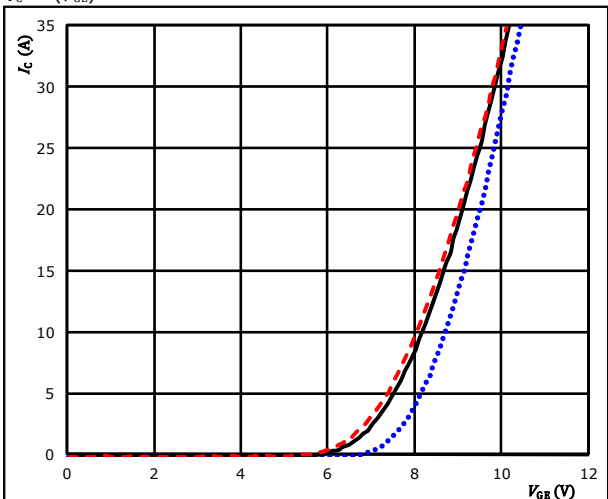

$t_p = 100 \mu s$ $T_j: 25 \text{ }^\circ C$
 $V_{CE} = 10 \text{ V}$ $T_j: 125 \text{ }^\circ C$ ———
 $T_j: 150 \text{ }^\circ C$ - - - -

figure 4. IGBT

Transient thermal impedance as function of pulse duration

$Z_{th(j-s)} = f(t_p)$

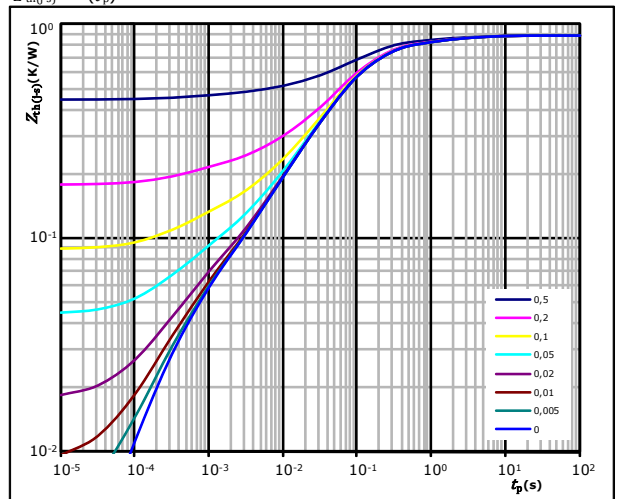

$D = t_p / T$
 $R_{th(j-s)} = 0,89 \text{ K/W}$

IGBT thermal model values

R (K/W)	τ (s)
4,56E-02	3,89E+00
8,84E-02	7,65E-01
3,30E-01	1,35E-01
2,86E-01	4,71E-02
8,94E-02	7,49E-03
3,24E-02	8,15E-04
1,67E-02	2,52E-04



Vincotech

10-FY12PMA035M7-P589A78
10-PY12PMA035M7-P589A78Y
10-F112PMA035M7-P589A79
10-P112PMA035M7-P589A79Y
datasheet

Inverter Switch Characteristics

figure 5. IGBT

Safe operating area

$$I_C = f(V_{CE})$$

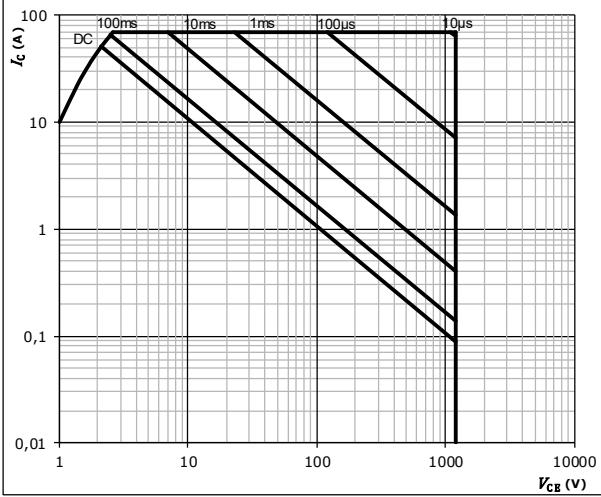

$D =$ single pulse
 $T_s = 80$ °C
 $V_{GE} = \pm 15$ V
 $T_j = T_{jmax}$



Inverter Diode Characteristics

figure 1. **FWD**

Typical forward characteristics

$$I_F = f(V_F)$$

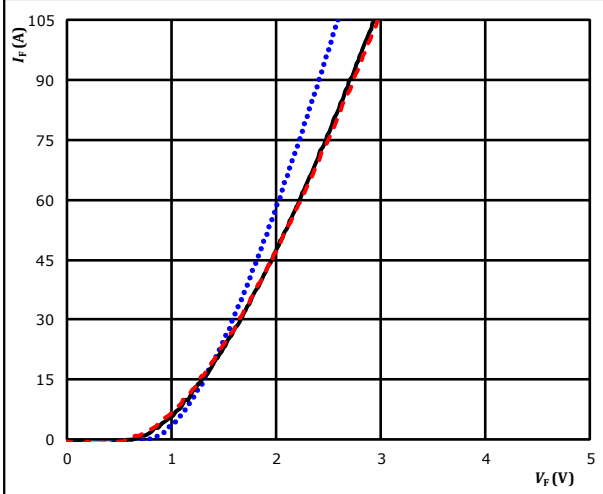

$t_p = 250 \mu s$

T_j : 25 °C
 125 °C ———
 150 °C - - - -

figure 2. **FWD**

Transient thermal impedance as a function of pulse width

$$Z_{th(j-s)} = f(t_p)$$

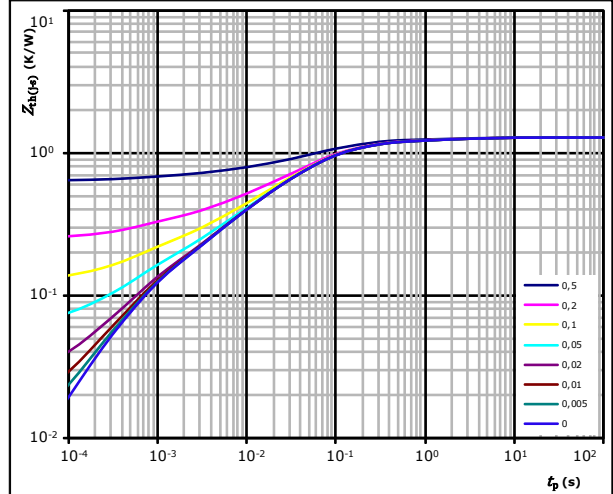

$D = t_p / T$

$R_{th(j-s)} = 1,27 \text{ K/W}$

FWD thermal model values

R (K/W)	τ (s)
5,82E-02	3,40E+00
1,11E-01	5,24E-01
4,63E-01	9,20E-02
3,72E-01	2,94E-02
1,72E-01	5,46E-03
9,36E-02	6,17E-04



Brake Switch Characteristics

figure 1. IGBT

Typical output characteristics

$I_C = f(V_{CE})$

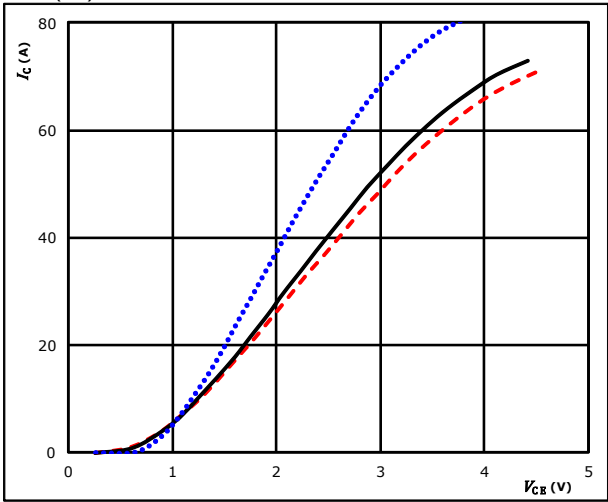

$t_p = 250 \mu s$ $T_j: 25 \text{ }^\circ C$
 $V_{GE} = 15 V$ $T_j: 125 \text{ }^\circ C$ ———
 $T_j: 150 \text{ }^\circ C$ - - - - -

figure 2. IGBT

Typical output characteristics

$I_C = f(V_{CE})$

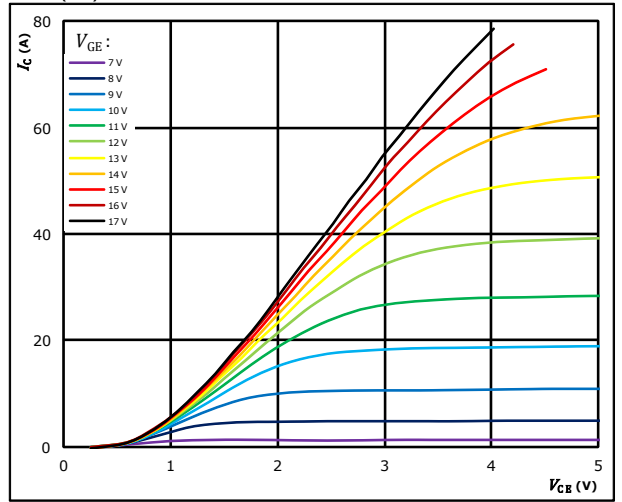

$t_p = 250 \mu s$
 $T_j = 125 \text{ }^\circ C$
 V_{GE} from 7 V to 17 V in steps of 1 V

figure 3. IGBT

Typical transfer characteristics

$I_C = f(V_{GE})$

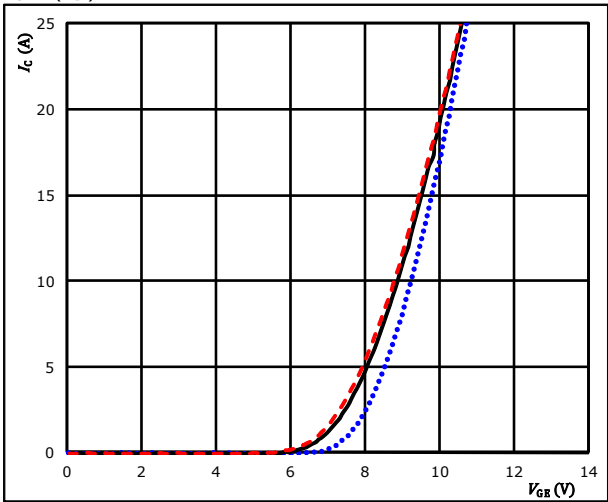

$t_p = 100 \mu s$ $T_j: 25 \text{ }^\circ C$
 $V_{CE} = 10 V$ $T_j: 125 \text{ }^\circ C$ ———
 $T_j: 150 \text{ }^\circ C$ - - - - -

figure 4. IGBT

Transient thermal impedance as function of pulse duration

$Z_{th(j-s)} = f(t_p)$

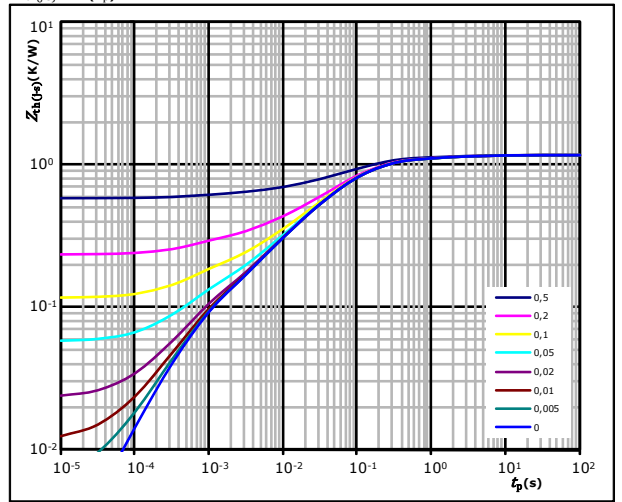

$D = t_p / T$
 $R_{th(j-s)} = 1,16 \text{ K/W}$

IGBT thermal model values

R (K/W)	τ (s)
5,33E-02	3,54E+00
1,07E-01	5,75E-01
5,05E-01	1,04E-01
2,68E-01	3,30E-02
1,51E-01	7,35E-03
7,80E-02	6,52E-04



Vincotech

10-FY12PMA035M7-P589A78
10-PY12PMA035M7-P589A78Y
10-F112PMA035M7-P589A79
10-P112PMA035M7-P589A79Y
datasheet

Brake Switch Characteristics

figure 5. IGBT

Safe operating area

$$I_C = f(V_{CE})$$

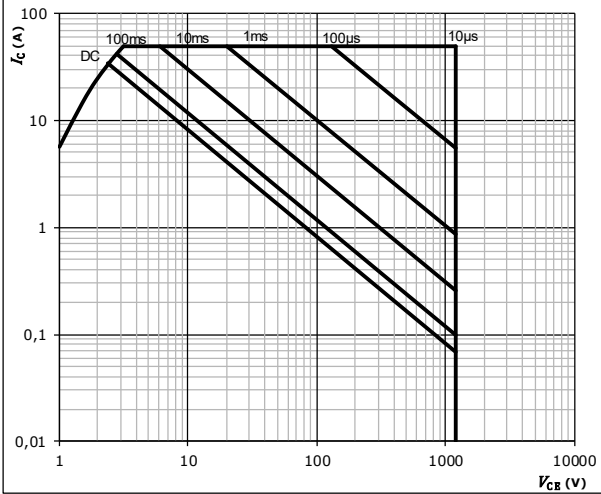

- $D =$ single pulse
- $T_s =$ 80 °C
- $V_{GE} =$ ±15 V
- $T_j =$ T_{jmax}



Brake Diode Characteristics

figure 1. FWD

Typical forward characteristics

$$I_F = f(V_F)$$

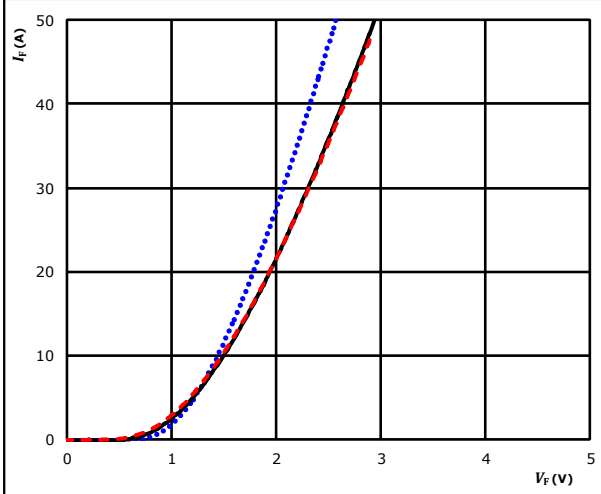

$t_p = 250 \mu s$
 T_j : 25 °C
 125 °C ———
 150 °C - - - -

figure 2. FWD

Transient thermal impedance as a function of pulse width

$$Z_{th(j-s)} = f(t_p)$$

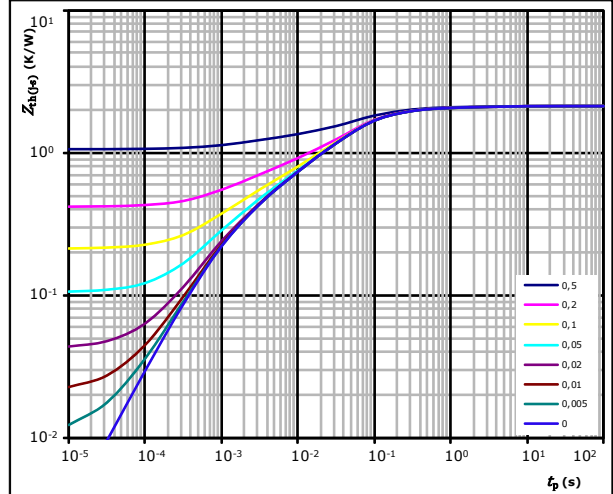

$D = t_p / T$
 $R_{th(j-s)} = 2,11 \text{ K/W}$
 FWD thermal model values

R (K/W)	τ (s)
8,99E-02	2,33E+00
4,04E-01	1,91E-01
1,05E+00	4,49E-02
3,39E-01	6,08E-03
2,29E-01	1,02E-03

Thermistor Characteristics

figure 1. Thermistor

Typical NTC characteristic as a function of temperature

$$R = f(T)$$

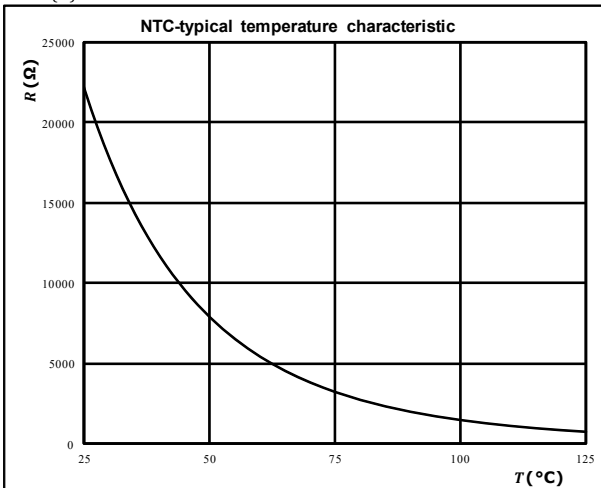



Inverter Switching Characteristics

figure 1. IGBT
 Typical switching energy losses as a function of collector current

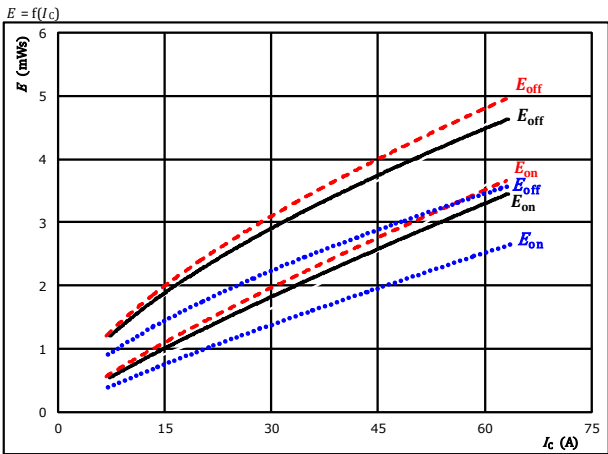

With an inductive load at
 $V_{CE} = 600 \text{ V}$
 $V_{GE} = \pm 15 \text{ V}$
 $R_{gon} = 8 \text{ } \Omega$
 $R_{goff} = 8 \text{ } \Omega$

T_j :
 25 °C (dotted blue)
 125 °C (solid black)
 150 °C (dashed red)

figure 2. IGBT
 Typical switching energy losses as a function of gate resistor

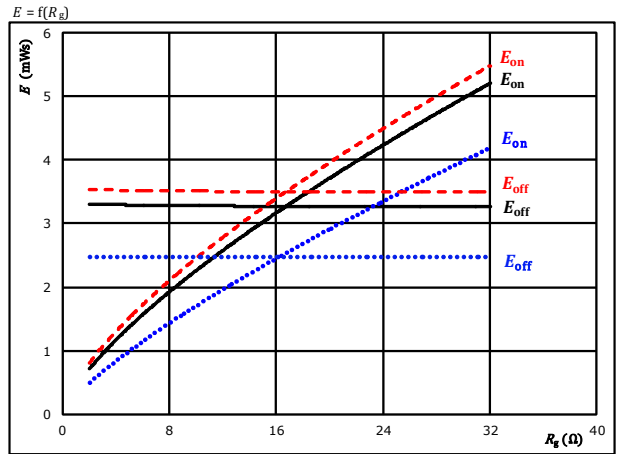

With an inductive load at
 $V_{CE} = 600 \text{ V}$
 $V_{GE} = \pm 15 \text{ V}$
 $I_C = 35 \text{ A}$

T_j :
 25 °C (dotted blue)
 125 °C (solid black)
 150 °C (dashed red)

figure 3. FWD
 Typical reverse recovered energy loss as a function of collector current

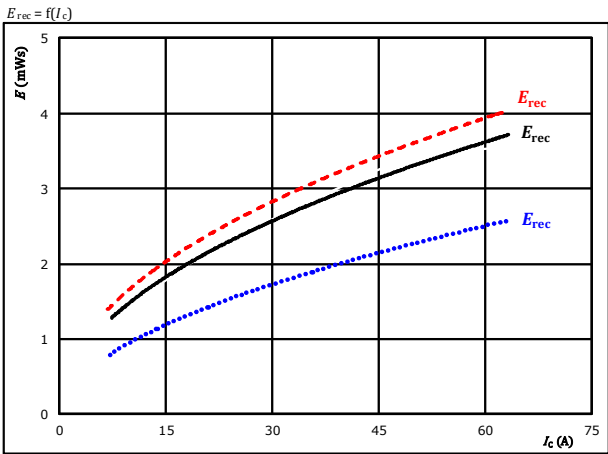

With an inductive load at
 $V_{CE} = 600 \text{ V}$
 $V_{GE} = \pm 15 \text{ V}$
 $R_{gon} = 8 \text{ } \Omega$

T_j :
 25 °C (dotted blue)
 125 °C (solid black)
 150 °C (dashed red)

figure 4. FWD
 Typical reverse recovered energy loss as a function of gate resistor

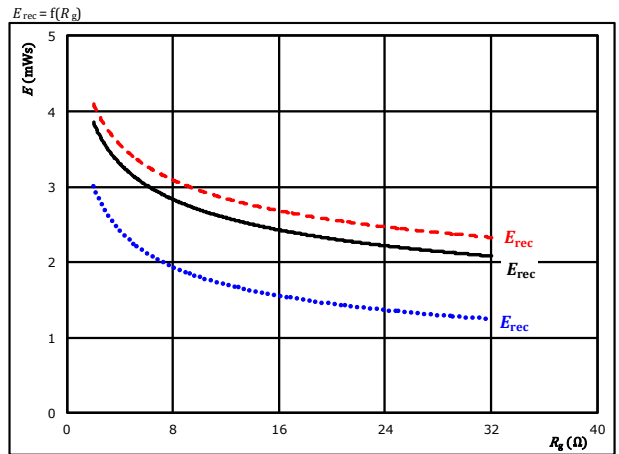

With an inductive load at
 $V_{CE} = 600 \text{ V}$
 $V_{GE} = \pm 15 \text{ V}$
 $I_C = 35 \text{ A}$

T_j :
 25 °C (dotted blue)
 125 °C (solid black)
 150 °C (dashed red)



Vincotech

10-FY12PMA035M7-P589A78
10-PY12PMA035M7-P589A78Y
10-F112PMA035M7-P589A79
10-P112PMA035M7-P589A79Y
 datasheet

Inverter Switching Characteristics

figure 5. IGBT

Typical switching times as a function of collector current

$$t = f(I_c)$$

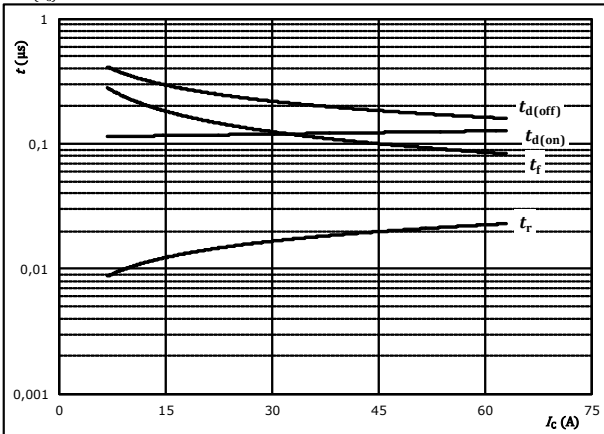

With an inductive load at

$T_j =$	150	°C
$V_{CE} =$	600	V
$V_{GE} =$	±15	V
$R_{gon} =$	8	Ω
$R_{goff} =$	8	Ω

figure 6. IGBT

Typical switching times as a function of gate resistor

$$t = f(R_g)$$

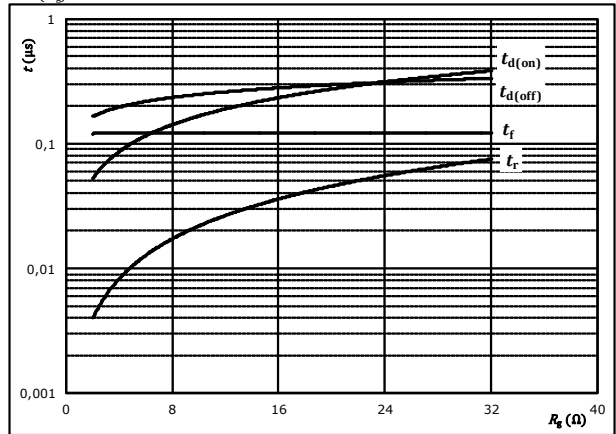

With an inductive load at

$T_j =$	150	°C
$V_{CE} =$	600	V
$V_{GE} =$	±15	V
$I_c =$	35	A

figure 7. FWD

Typical reverse recovery time as a function of collector current

$$t_{rr} = f(I_c)$$

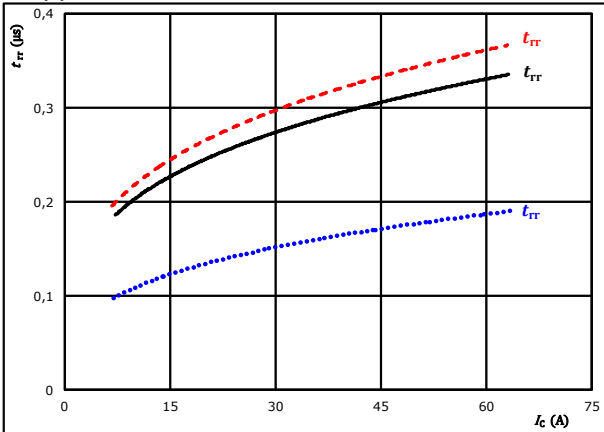

At	$V_{CE} =$	600	V	$T_j:$	25 °C
	$V_{GE} =$	±15	V		125 °C	————
	$R_{gon} =$	8	Ω		150 °C	-----

figure 8. FWD

Typical reverse recovery time as a function of IGBT turn on gate resistor

$$t_{rr} = f(R_{gon})$$

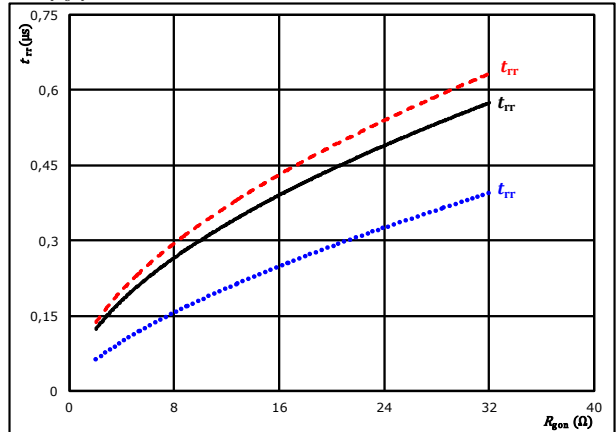

At	$V_{CE} =$	600	V	$T_j:$	25 °C
	$V_{GE} =$	±15	V		125 °C	————
	$I_c =$	35	A		150 °C	-----



Inverter Switching Characteristics

figure 9. FWD

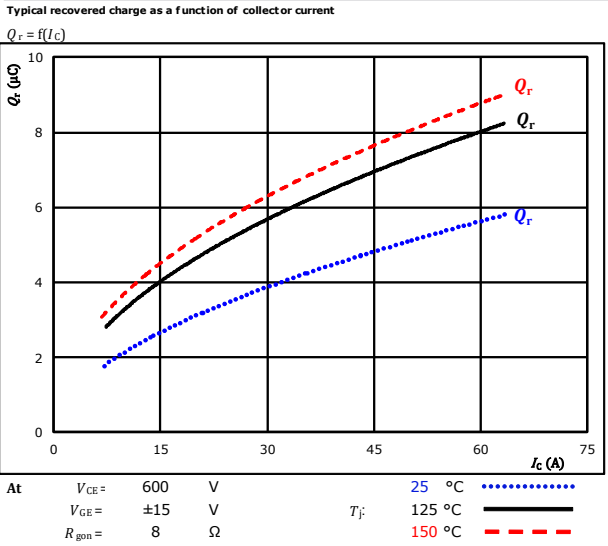

figure 10. FWD

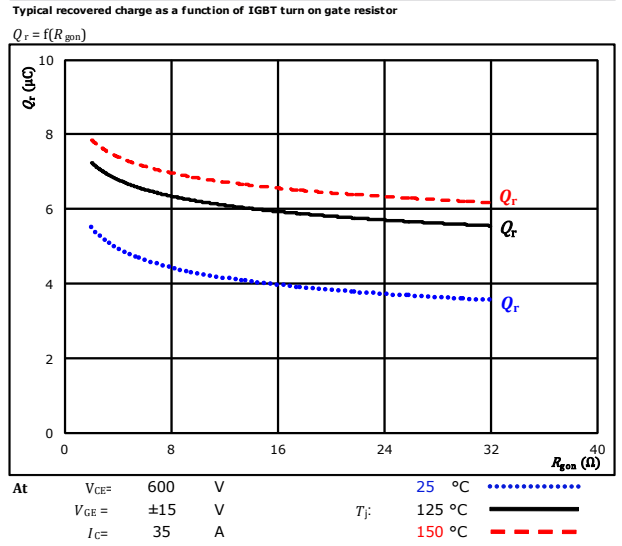

figure 11. FWD

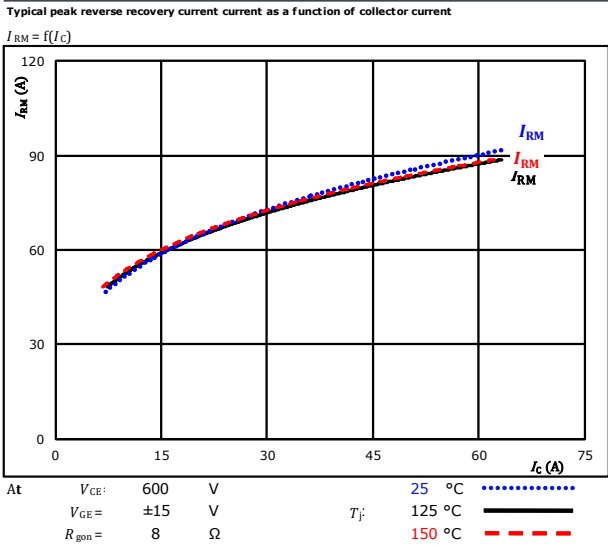
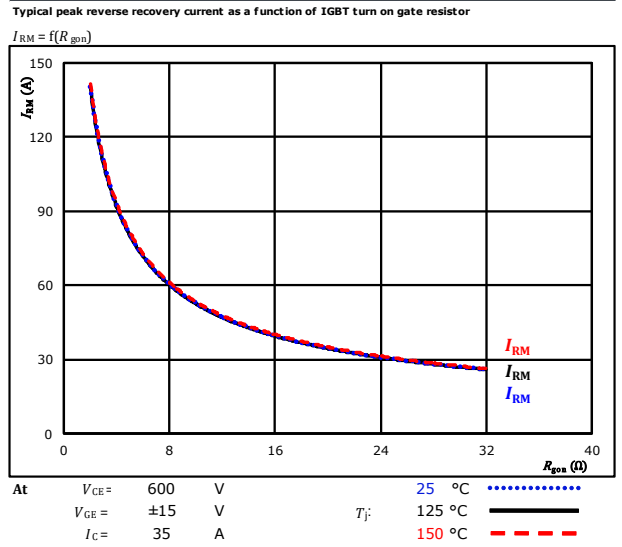

figure 12. FWD





Vincotech

10-FY12PMA035M7-P589A78
10-PY12PMA035M7-P589A78Y
10-F112PMA035M7-P589A79
10-P112PMA035M7-P589A79Y
 datasheet

Inverter Switching Characteristics

figure 13. FWD

Typical rate of fall of forward and reverse recovery current as a function of collector current
 $di_f/dt, di_{rr}/dt = f(I_c)$

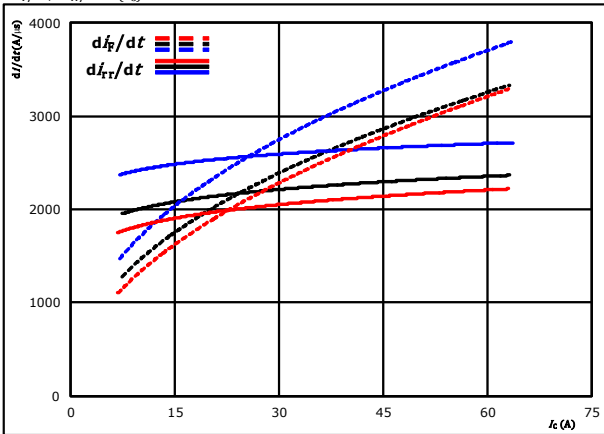

At $V_{CE} = 600$ V $T_j = 25$ °C
 $V_{GE} = \pm 15$ V $T_j = 125$ °C ———
 $R_{g0n} = 8$ Ω $T_j = 150$ °C - - - - -

figure 14. FWD

Typical rate of fall of forward and reverse recovery current as a function of IGBT turn on gate resistor
 $di_f/dt, di_{rr}/dt = f(R_{g0n})$

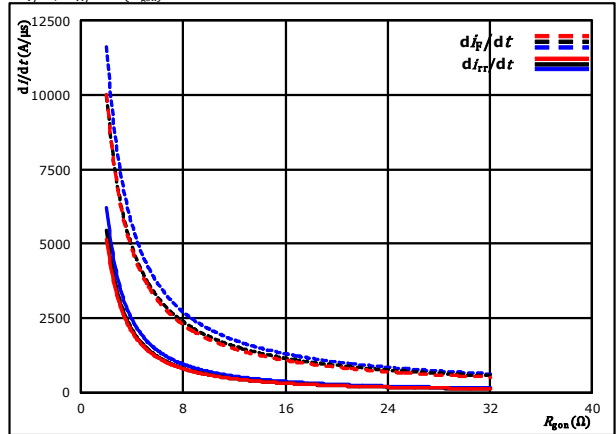

At $V_{CE} = 600$ V $T_j = 25$ °C
 $V_{GE} = \pm 15$ V $T_j = 125$ °C ———
 $I_c = 35$ A $T_j = 150$ °C - - - - -

figure 15. IGBT

Reverse bias safe operating area
 $I_c = f(V_{CE})$

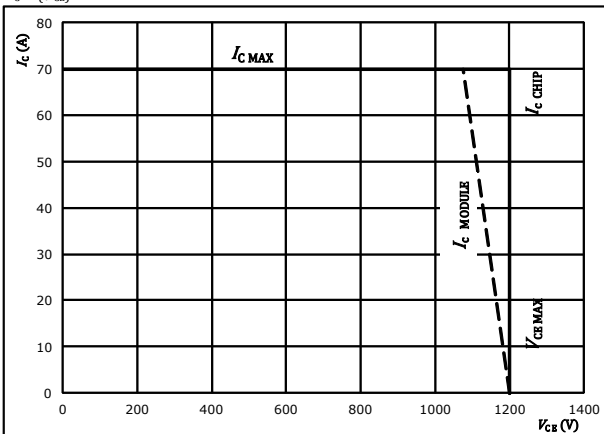

At $T_j = 175$ °C
 $R_{g0n} = 8$ Ω
 $R_{g0ff} = 8$ Ω



Inverter Switching Definitions

General conditions	
T_j	= 125 °C
R_{gon}	= 8 Ω
R_{goff}	= 8 Ω

figure 1. IGBT

Turn-off Switching Waveforms & definition of t_{doff} , t_{Eoff} (t_{Eoff} = integrating time for E_{off})

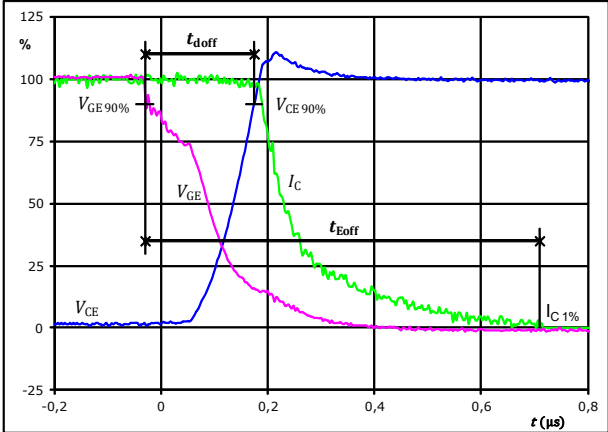

$V_{CE}(0\%) =$	-15	V
$V_{GE}(100\%) =$	15	V
$V_C(100\%) =$	600	V
$I_C(100\%) =$	35	A
$t_{doff} =$	0,203	μs
$t_{Eoff} =$	0,739	μs

figure 2. IGBT

Turn-on Switching Waveforms & definition of t_{don} , t_{Eon} (t_{Eon} = integrating time for E_{on})

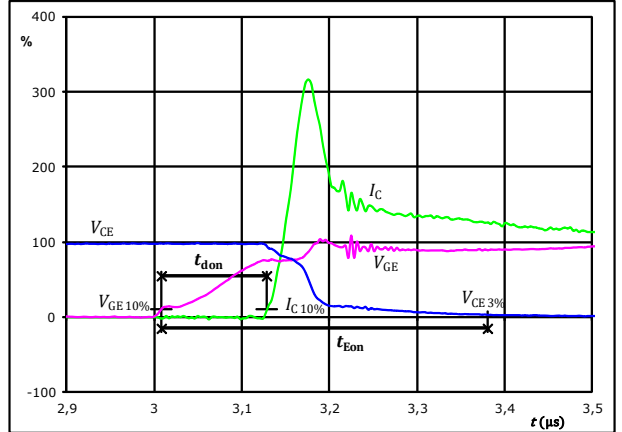

$V_{CE}(0\%) =$	-15	V
$V_{GE}(100\%) =$	15	V
$V_C(100\%) =$	600	V
$I_C(100\%) =$	35	A
$t_{don} =$	0,122	μs
$t_{Eon} =$	0,372	μs

figure 3. IGBT

Turn-off Switching Waveforms & definition of t_f

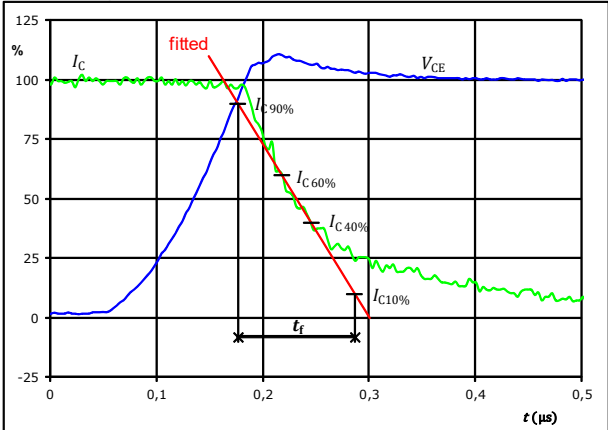

$V_C(100\%) =$	600	V
$I_C(100\%) =$	35	A
$t_f =$	0,118	μs

figure 4. IGBT

Turn-on Switching Waveforms & definition of t_r

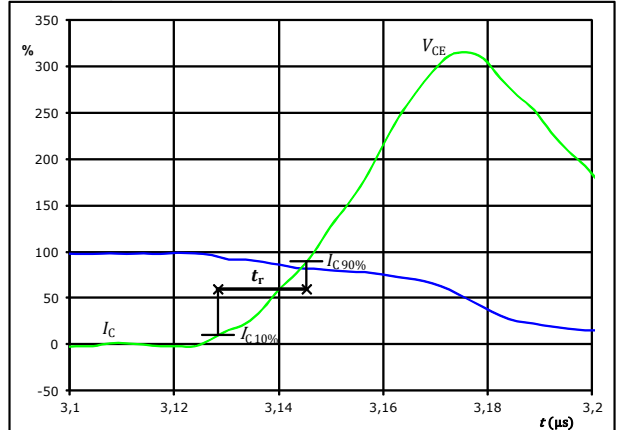

$V_C(100\%) =$	600	V
$I_C(100\%) =$	35	A
$t_r =$	0,017	μs



Vincotech

10-FY12PMA035M7-P589A78
10-PY12PMA035M7-P589A78Y
10-F112PMA035M7-P589A79
10-P112PMA035M7-P589A79Y
 datasheet

Inverter Switching Characteristics

figure 5. IGBT

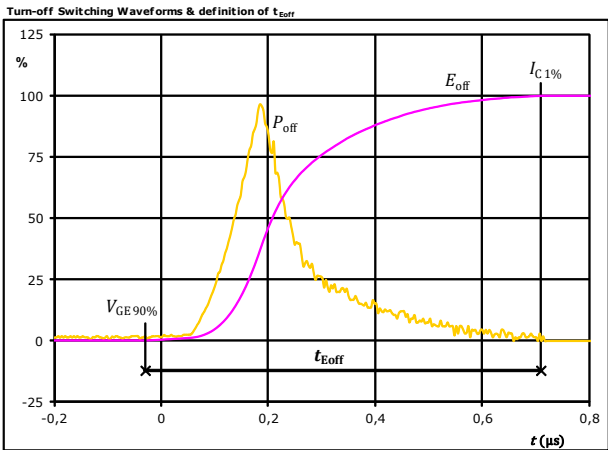

$P_{off}(100\%) =$	20,99	kW
$E_{off}(100\%) =$	3,17	mJ
$t_{Eoff} =$	0,74	µs

figure 6. IGBT

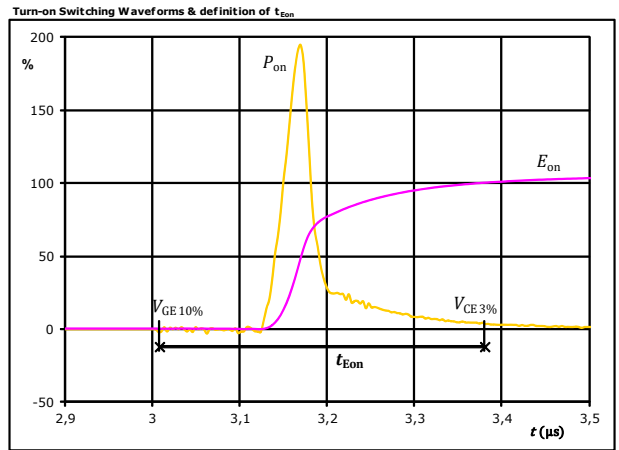

$P_{on}(100\%) =$	20,99	kW
$E_{on}(100\%) =$	1,92	mJ
$t_{Eon} =$	0,37	µs

figure 7. FWD

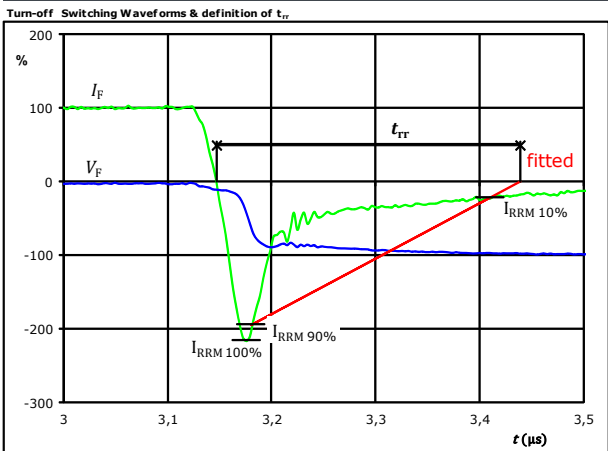

$V_F(100\%) =$	600	V
$I_F(100\%) =$	35	A
$I_{RRM}(100\%) =$	-76	A
$t_{tr} =$	0,284	µs



Vincotech

10-FY12PMA035M7-P589A78
10-PY12PMA035M7-P589A78Y
10-F112PMA035M7-P589A79
10-P112PMA035M7-P589A79Y
 datasheet

Inverter Switching Characteristics

figure 8. FWD

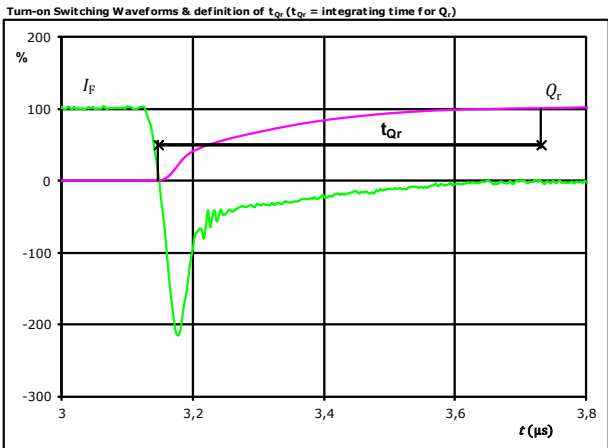

$I_F(100\%) =$	35	A
$Q_r(100\%) =$	6,18	μC
$t_{Qr} =$	0,58	μs

figure 9. FWD

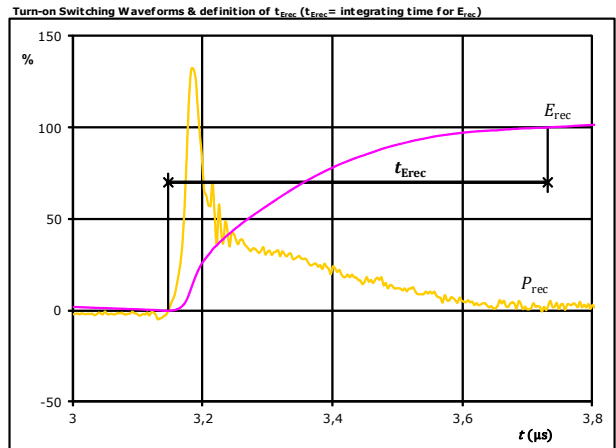

$P_{rec}(100\%) =$	20,99	kW
$E_{rec}(100\%) =$	2,82	mJ
$t_{Erec} =$	0,58	μs



Brake Switching Characteristics

figure 1. IGBT

Typical switching energy losses as a function of collector current

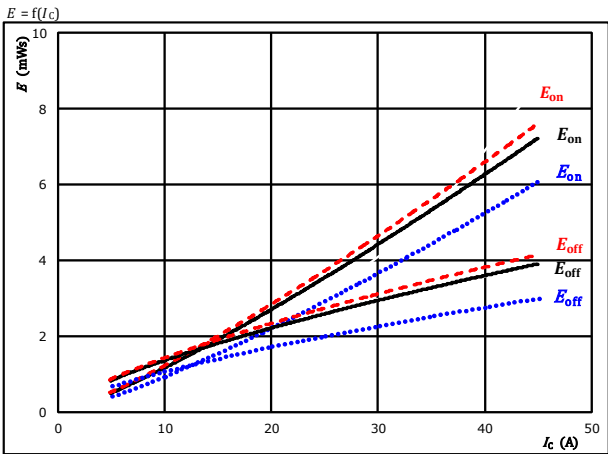

With an inductive load at
 $V_{CE} = 700$ V
 $V_{GE} = 15/0$ V
 $R_{gon} = 16$ Ω
 $R_{goff} = 16$ Ω

T_j : 25 °C (dotted blue), 125 °C (solid black), 150 °C (dashed red)

figure 2. IGBT

Typical switching energy losses as a function of gate resistor

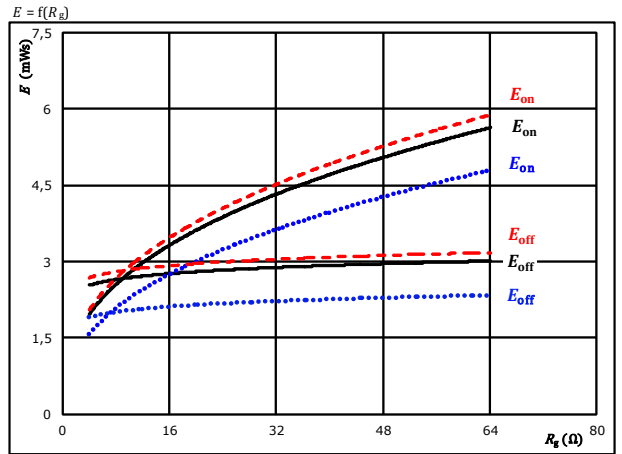

With an inductive load at
 $V_{CE} = 700$ V
 $V_{GE} = 15/0$ V
 $I_C = 25$ A

T_j : 25 °C (dotted blue), 125 °C (solid black), 150 °C (dashed red)

figure 3. FWD

Typical reverse recovered energy loss as a function of collector current

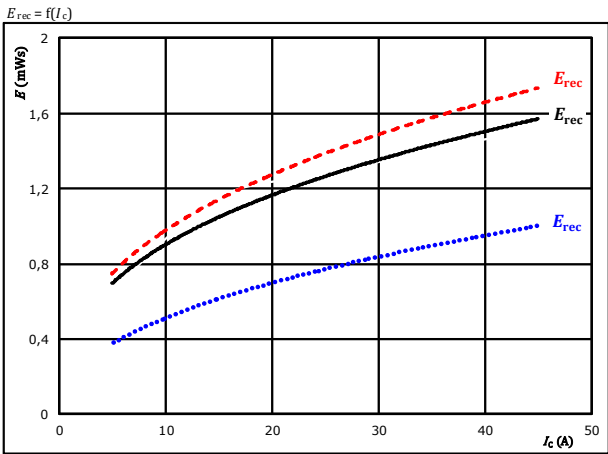

With an inductive load at
 $V_{CE} = 700$ V
 $V_{GE} = 15/0$ V
 $R_{gon} = 16$ Ω

T_j : 25 °C (dotted blue), 125 °C (solid black), 150 °C (dashed red)

figure 4. FWD

Typical reverse recovered energy loss as a function of gate resistor

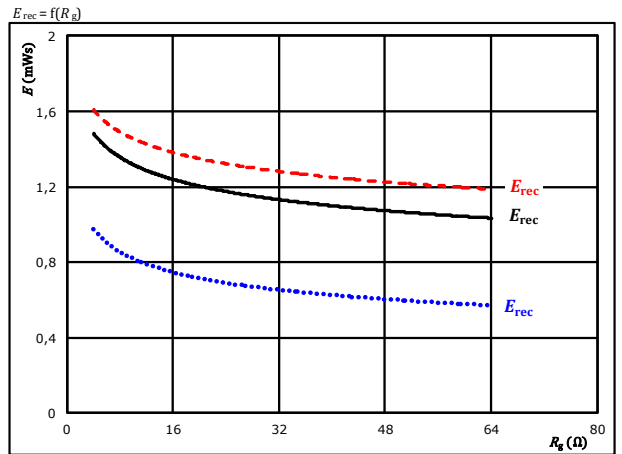

With an inductive load at
 $V_{CE} = 700$ V
 $V_{GE} = 15/0$ V
 $I_C = 25$ A

T_j : 25 °C (dotted blue), 125 °C (solid black), 150 °C (dashed red)



Vincotech

10-FY12PMA035M7-P589A78
10-PY12PMA035M7-P589A78Y
10-F112PMA035M7-P589A79
10-P112PMA035M7-P589A79Y
 datasheet

Brake Switching Characteristics

figure 5. IGBT

Typical switching times as a function of collector current

$$t = f(I_c)$$

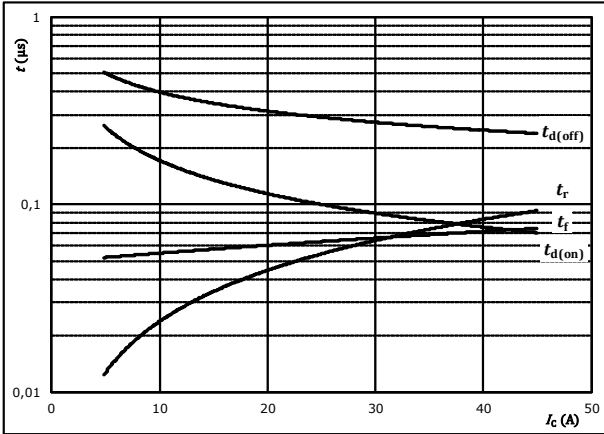

With an inductive load at

$T_j = 150$ °C
 $V_{CE} = 700$ V
 $V_{GE} = 15/0$ V
 $R_{gon} = 16$ Ω
 $R_{goff} = 16$ Ω

figure 6. IGBT

Typical switching times as a function of gate resistor

$$t = f(R_g)$$

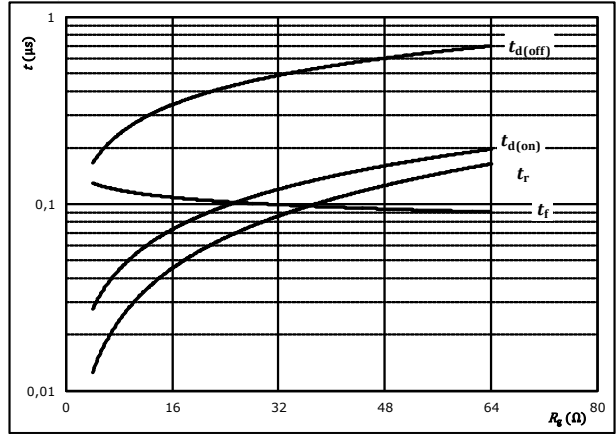

With an inductive load at

$T_j = 150$ °C
 $V_{CE} = 700$ V
 $V_{GE} = 15/0$ V
 $I_c = 25$ A

figure 7. FWD

Typical reverse recovery time as a function of collector current

$$t_{rr} = f(I_c)$$

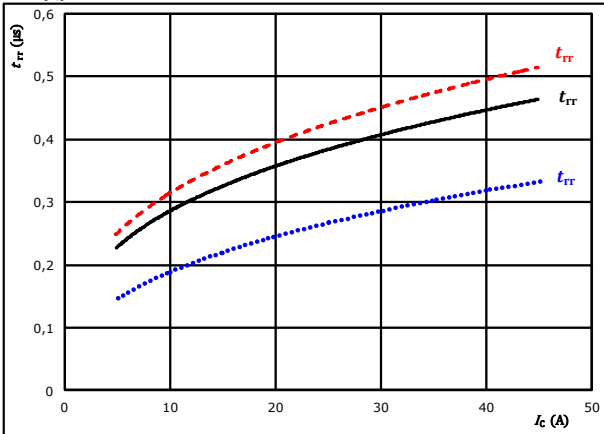

At $V_{CE} = 700$ V $T_j = 25$ °C
 $V_{GE} = 15/0$ V $T_j = 125$ °C ———
 $R_{gon} = 16$ Ω $T_j = 150$ °C - - -

figure 8. FWD

Typical reverse recovery time as a function of IGBT turn on gate resistor

$$t_{rr} = f(R_{gon})$$

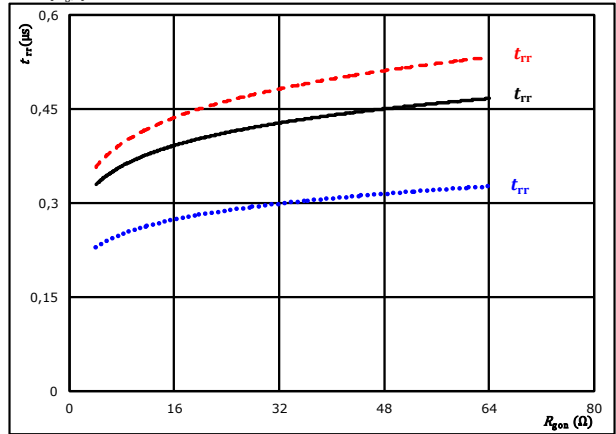

At $V_{CE} = 700$ V $T_j = 25$ °C
 $V_{GE} = 15/0$ V $T_j = 125$ °C ———
 $I_c = 25$ A $T_j = 150$ °C - - -



Brake Switching Characteristics

figure 9. FWD

Typical recovered charge as a function of collector current

$$Q_r = f(I_c)$$

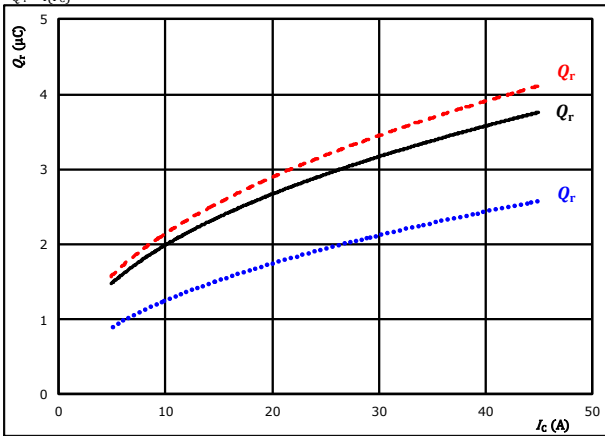

At $V_{CE} = 700$ V $T_j = 25$ °C
 $V_{GE} = 15/0$ V $T_j = 125$ °C ———
 $R_{gdn} = 16$ Ω $T_j = 150$ °C - - - - -

figure 10. FWD

Typical recovered charge as a function of IGBT turn on gate resistor

$$Q_r = f(R_{gdn})$$

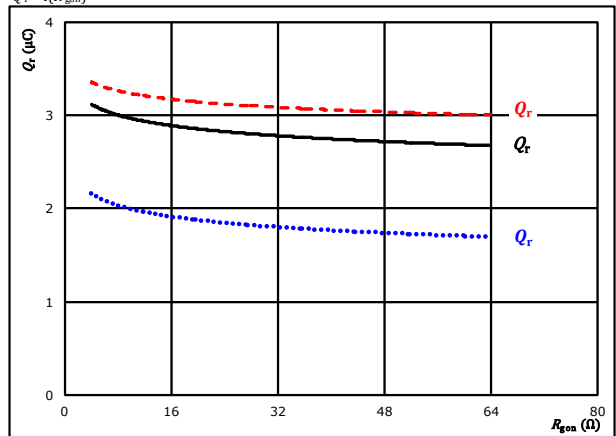

At $V_{CE} = 700$ V $T_j = 25$ °C
 $V_{GE} = 15/0$ V $T_j = 125$ °C ———
 $I_c = 25$ A $T_j = 150$ °C - - - - -

figure 11. FWD

Typical peak reverse recovery current as a function of collector current

$$I_{RM} = f(I_c)$$

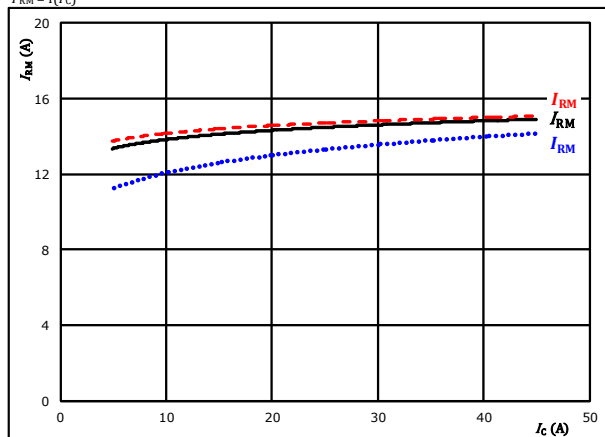

At $V_{CE} = 700$ V $T_j = 25$ °C
 $V_{GE} = 15/0$ V $T_j = 125$ °C ———
 $R_{gdn} = 16$ Ω $T_j = 150$ °C - - - - -

figure 12. FWD

Typical peak reverse recovery current as a function of IGBT turn on gate resistor

$$I_{RM} = f(R_{gdn})$$

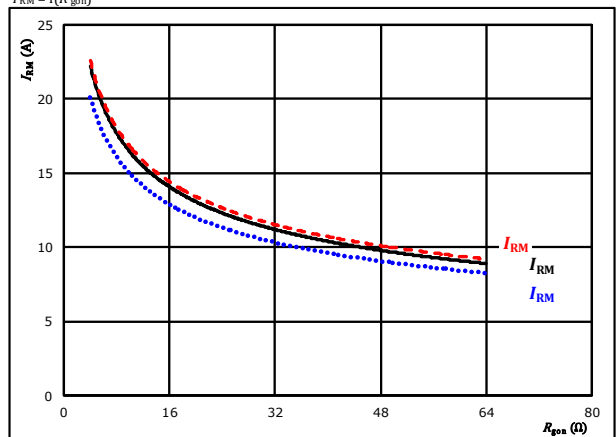

At $V_{CE} = 700$ V $T_j = 25$ °C
 $V_{GE} = 15/0$ V $T_j = 125$ °C ———
 $I_c = 25$ A $T_j = 150$ °C - - - - -



Vincotech

10-FY12PMA035M7-P589A78
10-PY12PMA035M7-P589A78Y
10-F112PMA035M7-P589A79
10-P112PMA035M7-P589A79Y
 datasheet

Brake Switching Characteristics

figure 13. FWD

Typical rate of fall of forward and reverse recovery current as a function of collector current
 $di_f/dt, di_{rr}/dt = f(I_c)$

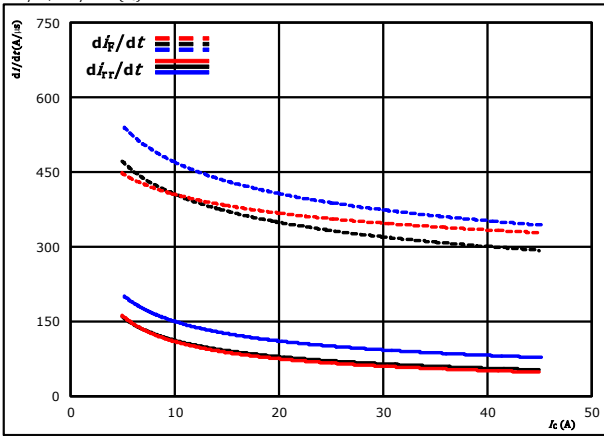

At $V_{CE} = 700$ V $T_j = 25$ °C
 $V_{GE} = 15/0$ V $T_j = 125$ °C ———
 $R_{g(on)} = 16$ Ω $T_j = 150$ °C - - - - -

figure 14. FWD

Typical rate of fall of forward and reverse recovery current as a function of IGBT turn on gate resistor
 $di_f/dt, di_{rr}/dt = f(R_{g(on)})$

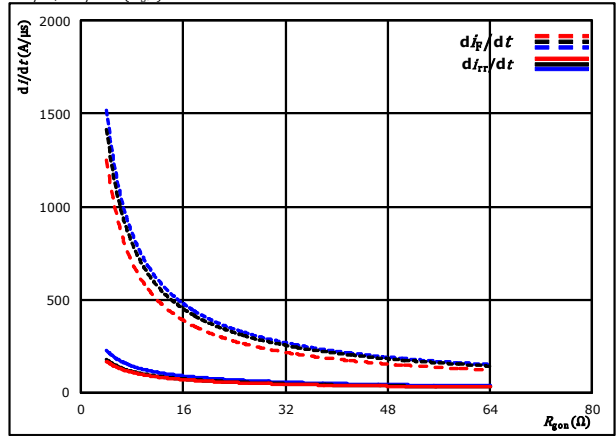

At $V_{CE} = 700$ V $T_j = 25$ °C
 $V_{GE} = 15/0$ V $T_j = 125$ °C ———
 $I_c = 25$ A $T_j = 150$ °C - - - - -

figure 15. IGBT

Reverse bias safe operating area
 $I_c = f(V_{CB})$

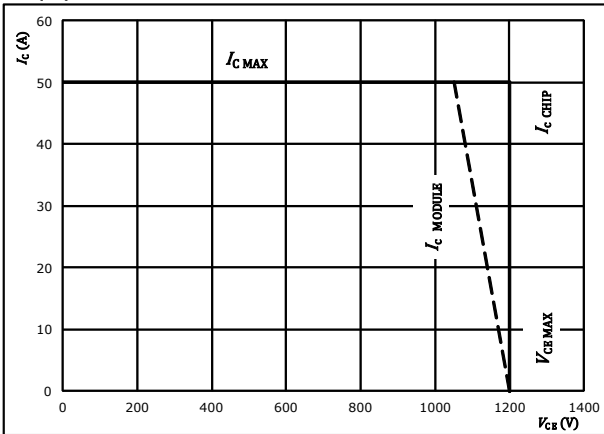

At $T_j = 175$ °C
 $R_{g(on)} = 16$ Ω
 $R_{g(off)} = 16$ Ω



Brake Switching Definitions

General conditions

T_j	=	125 °C
R_{gon}	=	16 Ω
R_{goff}	=	16 Ω

figure 1. IGBT

Turn-off Switching Waveforms & definition of t_{doff} , t_{Eoff} (t_{Eoff} = integrating time for E_{off})

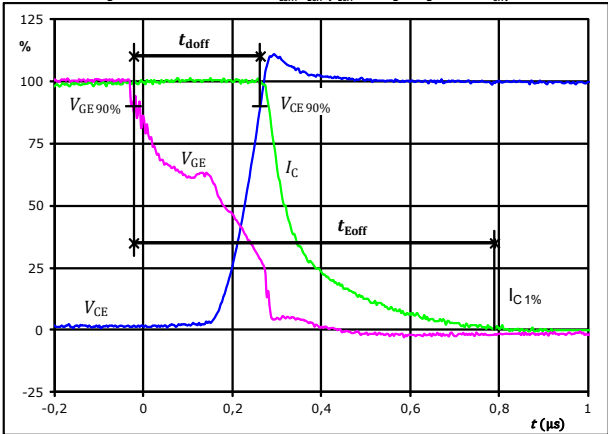

$V_{GE}(0\%) =$	0	V
$V_{GE}(100\%) =$	15	V
$V_C(100\%) =$	700	V
$I_C(100\%) =$	25	A
$t_{doff} =$	0,290	μs
$t_{Eoff} =$	0,812	μs

figure 2. IGBT

Turn-on Switching Waveforms & definition of t_{don} , t_{Eon} (t_{Eon} = integrating time for E_{on})

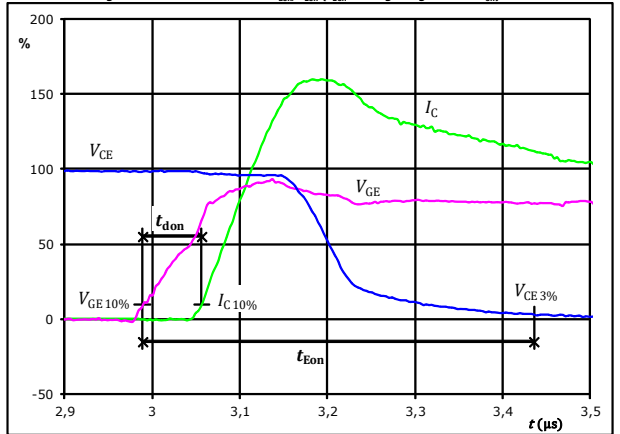

$V_{GE}(0\%) =$	0	V
$V_{GE}(100\%) =$	15	V
$V_C(100\%) =$	700	V
$I_C(100\%) =$	25	A
$t_{don} =$	0,067	μs
$t_{Eon} =$	0,446	μs

figure 3. IGBT

Turn-off Switching Waveforms & definition of t_f

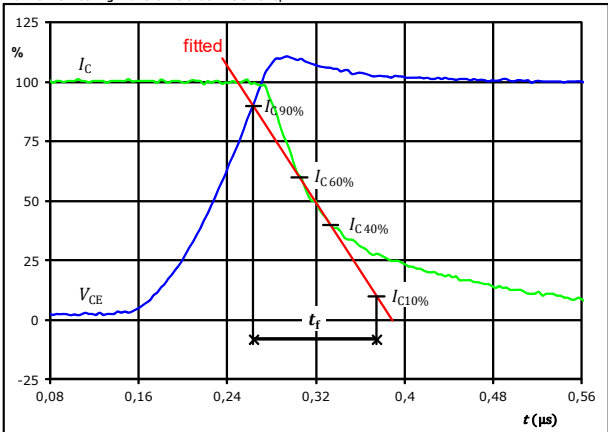

$V_C(100\%) =$	700	V
$I_C(100\%) =$	25	A
$t_f =$	0,117	μs

figure 4. IGBT

Turn-on Switching Waveforms & definition of t_r

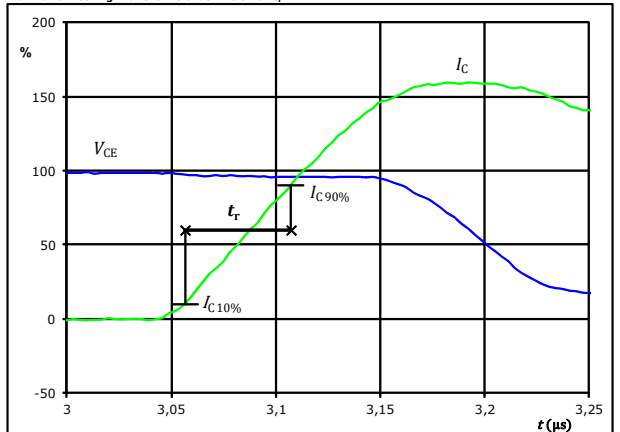

$V_C(100\%) =$	700	V
$I_C(100\%) =$	25	A
$t_r =$	0,050	μs



Vincotech

10-FY12PMA035M7-P589A78
10-PY12PMA035M7-P589A78Y
10-F112PMA035M7-P589A79
10-P112PMA035M7-P589A79Y
 datasheet

Brake Switching Characteristics

figure 5. IGBT

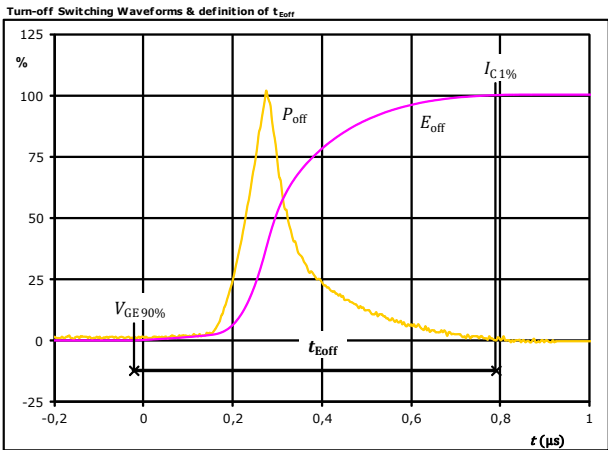

$P_{off}(100\%) = 17,58$ kW
 $E_{off}(100\%) = 2,65$ mJ
 $t_{Eoff} = 0,81$ μ s

figure 6. IGBT

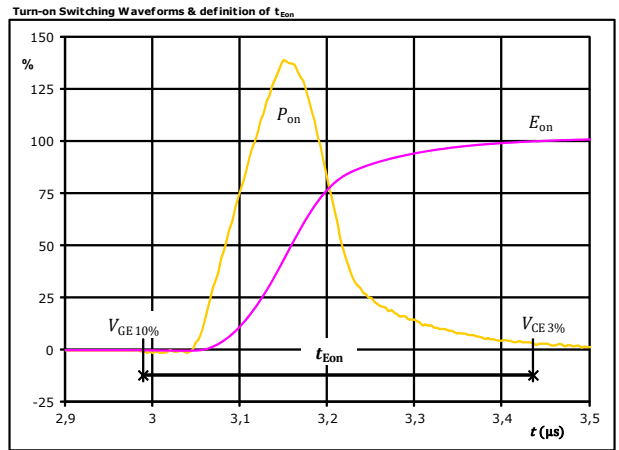

$P_{on}(100\%) = 17,58$ kW
 $E_{on}(100\%) = 3,11$ mJ
 $t_{Eon} = 0,45$ μ s

figure 7. FWD

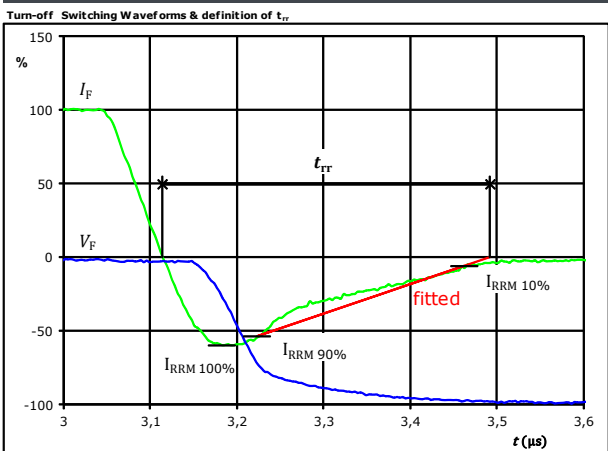

$V_F(100\%) = 700$ V
 $I_F(100\%) = 25$ A
 $I_{RRM}(100\%) = -15$ A
 $t_{rr} = 0,375$ μ s



Vincotech

10-FY12PMA035M7-P589A78
10-PY12PMA035M7-P589A78Y
10-F112PMA035M7-P589A79
10-P112PMA035M7-P589A79Y
 datasheet

Brake Switching Characteristics

figure 8. FWD

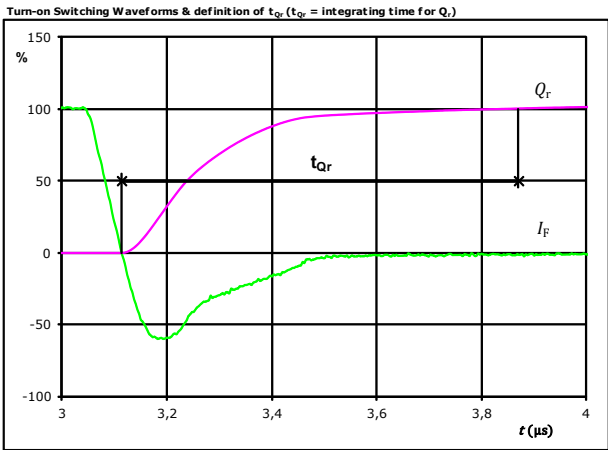

$I_F(100\%) =$	25	A
$Q_r(100\%) =$	2,90	μC
$t_{Qr} =$	0,76	μs

figure 9. FWD

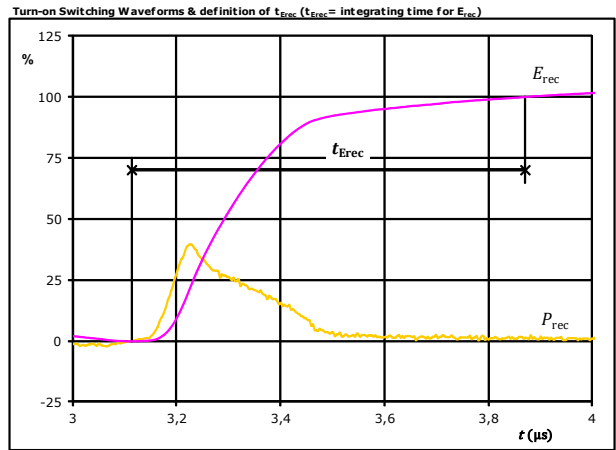

$P_{rec}(100\%) =$	17,58	kW
$E_{rec}(100\%) =$	1,28	mJ
$t_{Erec} =$	0,76	μs



Vincotech

10-FY12PMA035M7-P589A78
10-PY12PMA035M7-P589A78Y
10-F112PMA035M7-P589A79
10-P112PMA035M7-P589A79Y
 datasheet

Ordering Code & Marking								
Version			Ordering Code					
without thermal paste 12 mm housing with solder pins			10-FY12PMA035M7-P589A78					
with thermal paste 12 mm housing with solder pins			10-FY12PMA035M7-P589A78-/3/					
without thermal paste 12 mm housing with Press-fit pins			10-PY12PMA035M7-P589A78Y					
with thermal paste 12 mm housing with Press-fit pins			10-PY12PMA035M7-P589A78Y-/3/					
without thermal paste 17 mm housing with solder pins			10-F112PMA035M7-P589A79					
with thermal paste 17 mm housing with solder pins			10-F112PMA035M7-P589A79-/3/					
without thermal paste 17 mm housing with Press-fit pins			10-P112PMA035M7-P589A79Y					
with thermal paste 17 mm housing with Press-fit pins			10-P112PMA035M7-P589A79Y-/3/					
NN-NNNNNNNNNNNN TTTTIV WWYY UL VIN LLLLL SSSS			Text	Name	Date code	UL & VIN	Lot	Serial
			Datamatrix	NN-NNNNNNNNNNNN-TTTTIV	WWYY	UL VIN	LLLLL	SSSS
				Type&Ver	Lot number	Serial	Date code	
			TTTTIV	LLLLL	SSSS	WWYY		

Pin table				Outline	
Pin	X	Y	Function		
1	52,55	0	G27	P589A79Y	
2	47,7	0	DC-Rect		
3	44,8	0	DC-Rect		
4	37,8	0	DC+Rect		
5	37,8	2,8	DC+Rect		
6	35	0	DC+Inv		
7	35	2,8	DC+Inv		
8	28	0	Therm1		
9	25,2	0	Therm2		
10	22,4	0	DC-3	P589A79	
11	19,6	0	G15		
12	16,8	0	S15		
13	14	0	DC-2		
14	11,2	0	G13		
15	8,4	0	S13	P589A78	
16	5,6	0	DC-1		
17	2,8	0	G11		
18	0	0	S11		
19	0	28,5	Ph1	P589A78Y	
20	2,8	28,5	G12		
21	7,5	28,5	S12		
22	14,5	28,5	Ph2		
23	17,3	28,5	G14		
24	22	28,5	S14		
25	29	28,5	Ph3		
26	31,8	28,5	G16		
27	36,5	28,5	S16		
28	43,5	28,5	ACIn1		
29	52,55	25	ACIn2		
30	52,55	16,9	ACIn3		
31	52,55	8,6	Br		
32	52,55	2,8	DC-Br		

Tolerance of pinpositions: ±0.5mm at the end of pins
 Dimension of coordinate axis is only offset without tolerance



Vincotech

10-FY12PMA035M7-P589A78
10-PY12PMA035M7-P589A78Y
10-F112PMA035M7-P589A79
10-P112PMA035M7-P589A79Y
 datasheet

Pinout

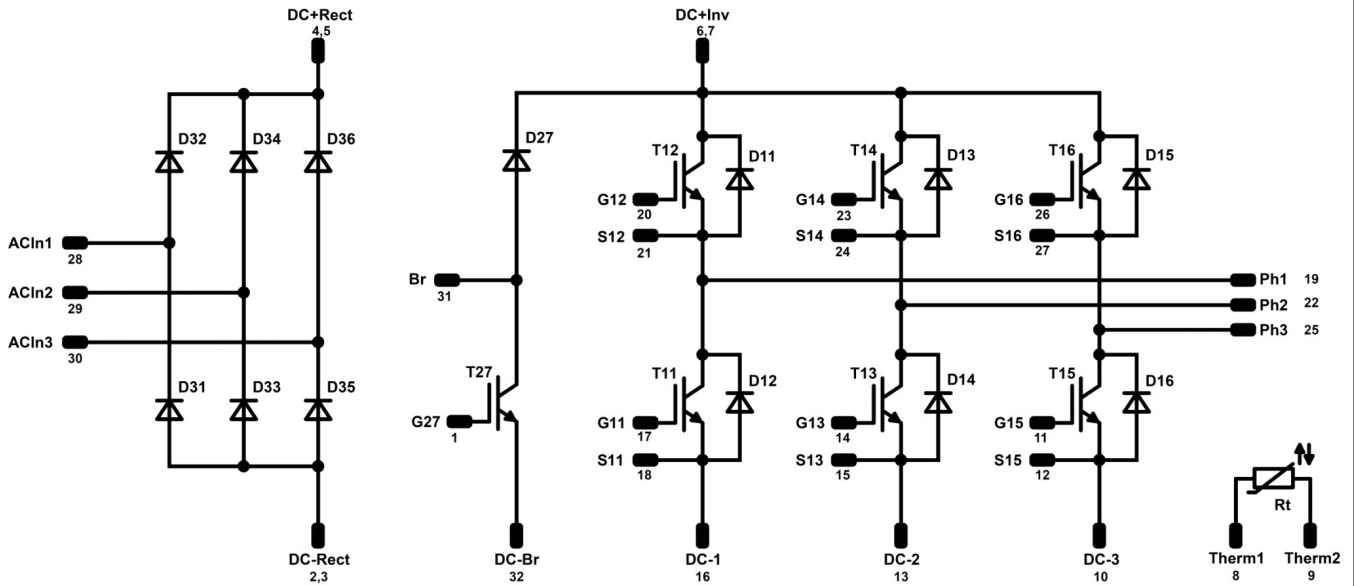

Identification

ID	Component	Voltage	Current	Function	Comment
D31, D32, D33, D34, D35, D36	Rectifier	1600 V	45 A	Rectifier Diode	
T11, T12, T13, T14, T15, T16	IGBT	1200 V	35 A	Inverter Switch	
D11, D12, D13, D14, D15, D16	FWD	1200 V	35 A	Inverter Diode	
T27	IGBT	1200 V	25 A	Brake Switch	
D27	FWD	1200 V	15 A	Brake Diode	
Rt	NTC			Thermistor	



Vincotech

10-FY12PMA035M7-P589A78
10-PY12PMA035M7-P589A78Y
10-F112PMA035M7-P589A79
10-P112PMA035M7-P589A79Y
datasheet

Packaging instruction			
Standard packaging quantity (SPQ) 100	>SPQ	Standard	<SPQ Sample

Handling instruction
Handling instructions for <i>flow</i> 1 packages see vincotech.com website.

Package data
Package data for <i>flow</i> 1 packages see vincotech.com website.

UL recognition and file number
This device is certified according to UL 1557 standard, UL file number E192116. For more information see vincotech.com website. 

Document No.:	Date:	Modification:	Pages
10-xx12PMA035M7-P589A7xx-D4-14	08 Mar. 2019	Correction of I_c/I_f values	1,2

DISCLAIMER

The information, specifications, procedures, methods and recommendations herein (together "information") are presented by Vincotech to reader in good faith, are believed to be accurate and reliable, but may well be incomplete and/or not applicable to all conditions or situations that may exist or occur. Vincotech reserves the right to make any changes without further notice to any products to improve reliability, function or design. No representation, guarantee or warranty is made to reader as to the accuracy, reliability or completeness of said information or that the application or use of any of the same will avoid hazards, accidents, losses, damages or injury of any kind to persons or property or that the same will not infringe third parties rights or give desired results. It is reader's sole responsibility to test and determine the suitability of the information and the product for reader's intended use.

LIFE SUPPORT POLICY

Vincotech products are not authorised for use as critical components in life support devices or systems without the express written approval of Vincotech.

As used herein:

1. Life support devices or systems are devices or systems which, (a) are intended for surgical implant into the body, or (b) support or sustain life, or (c) whose failure to perform when properly used in accordance with instructions for use provided in labelling can be reasonably expected to result in significant injury to the user.
2. A critical component is any component of a life support device or system whose failure to perform can be reasonably expected to cause the failure of the life support device or system, or to affect its safety or effectiveness.

单击下面可查看定价，库存，交付和生命周期等信息

[>>Vincotech\(威科\)](#)