

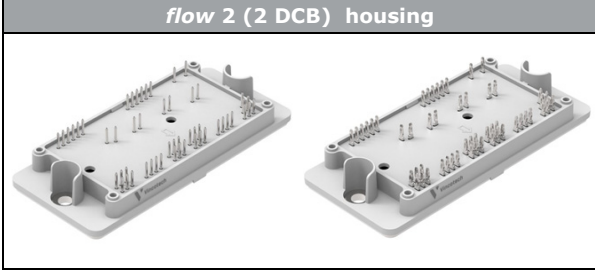
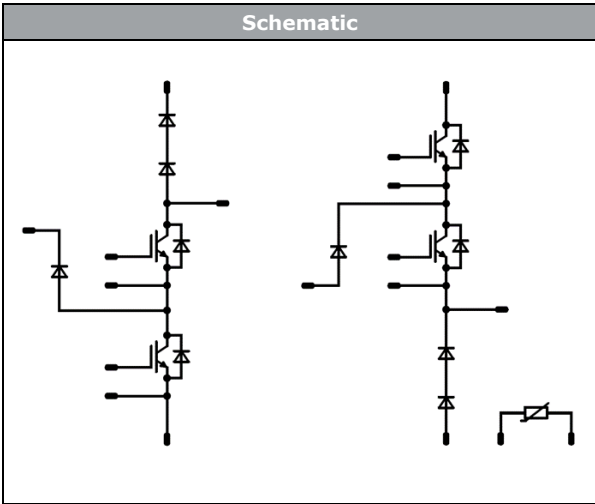

Vincotech

<i>flowNPC 2</i>	1200 V / 320 A
<div style="border: 1px solid black; padding: 5px; margin-bottom: 10px;"> <p style="text-align: center; background-color: #ccc; margin: 0;">Features</p> <ul style="list-style-type: none"> Fast switching IGBTs for fast switching frequencies Low inductive package </div> <div style="border: 1px solid black; padding: 5px; margin-bottom: 10px;"> <p style="text-align: center; background-color: #ccc; margin: 0;">Target applications</p> <ul style="list-style-type: none"> Solar Inverters </div> <div style="border: 1px solid black; padding: 5px;"> <p style="text-align: center; background-color: #ccc; margin: 0;">Types</p> <ul style="list-style-type: none"> 30-PT07NIA320RV-LE06F68Y 30-FT07NIA320RV-LE06F68 </div>	<div style="border: 1px solid black; padding: 5px; margin-bottom: 10px;"> <p style="text-align: center; background-color: #ccc; margin: 0;"><i>flow 2 (2 DCB) housing</i></p>  </div> <div style="border: 1px solid black; padding: 5px;"> <p style="text-align: center; background-color: #ccc; margin: 0;">Schematic</p>  </div>

Maximum Ratings

$T_j = 25\text{ °C}$, unless otherwise specified

Parameter	Symbol	Condition	Value	Unit
Buck Switch				
Collector-emitter voltage	V_{CES}		650	V
Collector current	I_C	$T_j = T_{jmax}$ $T_s = 80\text{ °C}$	195	A
Repetitive peak collector current	I_{CRM}	t_p limited by T_{jmax}	1280	A
Total power dissipation	P_{tot}	$T_j = T_{jmax}$ $T_s = 80\text{ °C}$	288	W
Gate-emitter voltage	V_{GES}		±30	V
Short circuit ratings	t_{SC}	$V_{GE} = 15\text{ V}$ $V_{CC} = 360\text{ V}$ $T_j = 25\text{ °C}$	2	μs
Maximum junction temperature	T_{jmax}		175	°C



Vincotech

**30-PT07NIA320RV-LE06F68Y /
30-FT07NIA320RV-LE06F68**
datasheet

Maximum Ratings

$T_j = 25\text{ °C}$, unless otherwise specified

Parameter	Symbol	Condition	Value	Unit
-----------	--------	-----------	-------	------

Buck Diode

Peak repetitive reverse voltage	V_{RRM}		650	V
Continuous (direct) forward current	I_F	$T_j = T_{jmax}$ $T_s = 80\text{ °C}$	166	A
Repetitive peak forward current	I_{FRM}		1280	A
Total power dissipation	P_{tot}	$T_j = T_{jmax}$ $T_s = 80\text{ °C}$	206	W
Maximum junction temperature	T_{jmax}		175	°C

Boost Switch

Collector-emitter voltage	V_{CES}		650	V
Collector current	I_C	$T_j = T_{jmax}$ $T_s = 80\text{ °C}$	195	A
Repetitive peak collector current	I_{CRM}	t_p limited by T_{jmax}	1280	A
Total power dissipation	P_{tot}	$T_j = T_{jmax}$ $T_s = 80\text{ °C}$	288	W
Gate-emitter voltage	V_{GES}		±30	V
Short circuit ratings	t_{SC}	$V_{GE} = 15\text{ V}$ $V_{CC} = 360\text{ V}$ $T_j = 25\text{ °C}$	2	µs
Maximum junction temperature	T_{jmax}		175	°C

Boost Diode

Peak repetitive reverse voltage	V_{RRM}		1300	V
Continuous (direct) forward current	I_F	$T_j = T_{jmax}$ $T_s = 80\text{ °C}$	168	A
Repetitive peak forward current	I_{FRM}		1280	A
Total power dissipation	P_{tot}	$T_j = T_{jmax}$ $T_s = 80\text{ °C}$	419	W
Maximum junction temperature	T_{jmax}		175	°C

Buck Sw. Protection Diode

Peak repetitive reverse voltage	V_{RRM}		650	V
Continuous (direct) forward current	I_F		30	A
Repetitive peak forward current	I_{FRM}		120	A
Total power dissipation	P_{tot}	$T_j = T_{jmax}$ $T_s = 80\text{ °C}$	58	W
Maximum junction temperature	T_{jmax}		175	°C



Maximum Ratings

$T_j = 25\text{ °C}$, unless otherwise specified

Parameter	Symbol	Condition	Value	Unit
Boost Sw. Protection Diode				
Peak repetitive reverse voltage	V_{RRM}		650	V
Continuous (direct) forward current	I_F		30	A
Repetitive peak forward current	I_{FRM}		120	A
Total power dissipation	P_{tot}	$T_j = T_{jmax}$ $T_s = 80\text{ °C}$	58	W
Maximum junction temperature	T_{jmax}		175	°C

Module Properties

Thermal Properties

Storage temperature	T_{stg}		-40...+125	°C
Operation temperature under switching condition	T_{top}		-40...(T _{jmax} - 25)	°C

Isolation Properties

Isolation voltage	V_{isol}	DC Test Voltage* $t_p = 2\text{ s}$	4000	V
		AC Voltage $t_p = 1\text{ min}$	2500	V
Creepage distance			min. 12,7	mm
Clearance			min. 12,7	mm
Comparative Tracking Index	CTI		> 200	

*100 % tested in production



Characteristic Values

Parameter	Symbol	Conditions					Value			Unit
		V_{GS} [V]	V_{GE} [V]	V_{DS} [V]	I_D [A]	T_j [°C]	Min	Typ	Max	

Buck Switch

Static

Parameter	Symbol	V_{GS} [V]	V_{GE} [V]	V_{DS} [V]	I_D [A]	T_j [°C]	Min	Typ	Max	Unit
Gate-emitter threshold voltage	$V_{GE(th)}$		5		0,2284	25	5	6	7	V
Collector-emitter saturation voltage	V_{CESat}	15			320	25 125 150		1,65 1,69 1,75	1,9	V
Collector-emitter cut-off current	I_{CES}	0	650			25			40	μA
Gate-emitter leakage current	I_{GES}	30	0			25			800	nA
Internal gate resistance	r_g							none		Ω
Input capacitance	C_{ies}							19240		pF
Output capacitance	C_{oes}	$f = 1$ Mhz	0	30		25		736		
Reverse transfer capacitance	C_{res}							316		
Gate charge	Q_g	15	400	320		25		684		nC

Thermal

Parameter	Symbol	Conditions	Min	Typ	Max	Unit
Thermal resistance junction to sink	$R_{th(j-s)}$	$\lambda_{paste} = 3,4$ W/mK (PSX)				0,33 K/W

Dynamic

Parameter	Symbol	Conditions	V_{GS} [V]	V_{GE} [V]	V_{DS} [V]	I_D [A]	T_j [°C]	Min	Typ	Max	Unit
Turn-on delay time	$t_{d(on)}$	$R_{gon} = 2$ Ω $R_{goff} = 2$ Ω	±15	350	320		25	115			ns
Rise time	t_r							125	107		
								150	109		
								25	12		
Turn-off delay time	$t_{d(off)}$							25	113		
								125	122		
								150	125		
Fall time	t_f	25	34								
		125	42								
		150	43								
Turn-on energy (per pulse)	E_{on}	$Q_{t-FWD} = 10,5$ μC $Q_{t-FWD} = 16,5$ μC $Q_{t-FWD} = 19$ μC					25	1,099			mWs
125	2,351										
150	2,418										
Turn-off energy (per pulse)	E_{off}						25	4,483			
								125	5,425		
								150	5,902		



Vincotech

30-PT07NIA320RV-LE06F68Y /
30-FT07NIA320RV-LE06F68
 datasheet

Characteristic Values

Parameter	Symbol	Conditions					Value			Unit
		V_{GE} [V]	V_{CE} [V]	I_C [A]	T_j [°C]	Min	Typ	Max		

Buck Diode

Static

Parameter	Symbol	V_{GE} [V]	V_{CE} [V]	I_C [A]	T_j [°C]	Min	Typ	Max	Unit
Forward voltage	V_F			320	25 125 150		1,55 1,62 1,62	1,9	V
Reverse leakage current	I_R		650		25			40	μA

Thermal

Parameter	Symbol	Conditions	Value	Unit
Thermal resistance junction to sink	$R_{th(j-s)}$	$\lambda_{paste} = 3,4$ W/mK (PSX)	0,46	K/W

Dynamic

Parameter	Symbol	V_{GE} [V]	V_{CE} [V]	I_C [A]	T_j [°C]	Min	Typ	Max	Unit
Peak recovery current	I_{RRM}				25 125 150		400 431 444		A
Reverse recovery time	t_{rr}				25 125 150		55 69 90		ns
Recovered charge	Q_r	± 15	350	320	25 125 150		10,548 16,458 18,955		μC
Reverse recovered energy	E_{rec}				25 125 150		2,849 3,688 4,392		mWs
Peak rate of fall of recovery current	$(di_{rr}/dt)_{max}$				25 125 150		22078 14420 13032		A/μs



Vincotech

30-PT07NIA320RV-LE06F68Y /
30-FT07NIA320RV-LE06F68
 datasheet

Characteristic Values

Parameter	Symbol	Conditions					Value			Unit
		V_{GS} [V]	V_{GE} [V]	V_{DS} [V]	I_D [A]	T_j [°C]	Min	Typ	Max	

Boost Switch

Static

Parameter	Symbol	V_{GS} [V]	V_{GE} [V]	V_{DS} [V]	I_D [A]	T_j [°C]	Min	Typ	Max	Unit
Gate-emitter threshold voltage	$V_{GE(th)}$		5		0,2284	25	5	6	7	V
Collector-emitter saturation voltage	V_{CESat}	15			320	25 125 150		1,65 1,69 1,75	1,9	V
Collector-emitter cut-off current	I_{CES}	0	650			25			40	μA
Gate-emitter leakage current	I_{GES}	30	0			25			800	nA
Internal gate resistance	r_g							none		Ω
Input capacitance	C_{ies}							19240		pF
Output capacitance	C_{oes}	$f=1\text{ Mhz}$	0	30		25		736		
Reverse transfer capacitance	C_{res}							316		
Gate charge	Q_g	15	400	320		25		684		nC

Thermal

Parameter	Symbol	Conditions	Min	Typ	Max	Unit
Thermal resistance junction to sink	$R_{th(j-s)}$	$\lambda_{paste} = 3,4\text{ W/mK}$ (PSX)				0,33 K/W

Dynamic

Parameter	Symbol	Conditions	V_{GS} [V]	V_{GE} [V]	V_{DS} [V]	I_D [A]	T_j [°C]	Min	Typ	Max	Unit
Turn-on delay time	$t_{d(on)}$						25 125 150		112 111 111		ns
Rise time	t_r	$R_{gon} = 2\ \Omega$ $R_{goff} = 2\ \Omega$					25 125 150		14 14 15		
Turn-off delay time	$t_{d(off)}$						25 125 150		116 124 127		
Fall time	t_f						25 125 150		31 43 47		
Turn-on energy (per pulse)	E_{on}	$Q_{tFWD} = 10,5\ \mu\text{C}$ $Q_{tFWD} = 16,9\ \mu\text{C}$ $Q_{tFWD} = 19,3\ \mu\text{C}$					25 125 150		0,970 2,030 2,438		
Turn-off energy (per pulse)	E_{off}						25 125 150		4,562 5,445 6,064		



Characteristic Values

Parameter	Symbol	Conditions					Value			Unit
		V_{GE} [V]	V_{CE} [V]	I_C [A]	T_j [°C]	Min	Typ	Max		

Boost Diode

Static

Parameter	Symbol	V_{GE} [V]	V_{CE} [V]	I_C [A]	T_j [°C]	Min	Typ	Max	Unit
Forward voltage	V_F			320	25 125 150		3,08 3,30 3,26	3,8	V
Reverse leakage current	I_R		1300		25			40	μA

Thermal

Parameter	Symbol	Conditions	Value	Unit
Thermal resistance junction to sink	$R_{th(j-s)}$	$\lambda_{paste} = 3,4$ W/mK (PSX)	0,23	K/W

Dynamic

Parameter	Symbol	V_{GE} [V]	V_{CE} [V]	I_C [A]	T_j [°C]	Min	Typ	Max	Unit
Peak recovery current	I_{RRM}				25 125 150		340 368 380		A
Reverse recovery time	t_{rr}				25 125 150		42 131 137		ns
Recovered charge	Q_r	± 15	350	320	25 125 150		10,512 16,942 19,349		μC
Reverse recovered energy	E_{rec}				25 125 150		2,913 3,944 4,643		mWs
Peak rate of fall of recovery current	$(di_{rr}/dt)_{max}$				25 125 150		28026 19719 17394		A/μs

Buck Sw. Protection Diode

Static

Parameter	Symbol	V_{GE} [V]	V_{CE} [V]	I_C [A]	T_j [°C]	Min	Typ	Max	Unit
Forward voltage	V_F			30	25 125 150		1,58 1,75 1,70	1,9	V
Reverse leakage current	I_R		650		25			10	μA

Thermal

Parameter	Symbol	Conditions	Value	Unit
Thermal resistance junction to sink	$R_{th(j-s)}$	$\lambda_{paste} = 3,4$ W/mK (PSX)	1,63	K/W



Characteristic Values

Parameter	Symbol	Conditions					Value			Unit
		V_{GE} [V]	V_{CE} [V]	I_C [A]	T_j [°C]	Min	Typ	Max		

Boost Sw. Protection Diode

Static

Parameter	Symbol	V_{GS} [V]	V_{DS} [V]	I_D [A]	T_j [°C]	Min	Typ	Max	Unit
Forward voltage	V_F			30	25 125 150		1,58 1,75 1,70	1,9	V
Reverse leakage current	I_R		650		25			10	μ A

Thermal

Parameter	Symbol	Conditions	Value	Unit
Thermal resistance junction to sink	$R_{th(j-s)}$	$\lambda_{paste} = 3,4$ W/mK (PSX)	1,63	K/W

Thermistor

Parameter	Symbol	Conditions	T_j [°C]	Value	Unit
Rated resistance	R		25	22	k Ω
Deviation of R_{100}	$\Delta_{R/R}$	$R_{100} = 1484 \Omega$	100	-5	%
Power dissipation	P		25	5	mW
Power dissipation constant			25	1,5	mW/K
B-value	$B_{(25/50)}$	Tol. ± 1 %	25	3962	K
B-value	$B_{(25/100)}$	Tol. ± 1 %	25	4000	K
Vincotech NTC Reference				I	



Vincotech

Buck Switch Characteristics

figure 1. IGBT

Typical output characteristics

$$I_C = f(V_{CE})$$

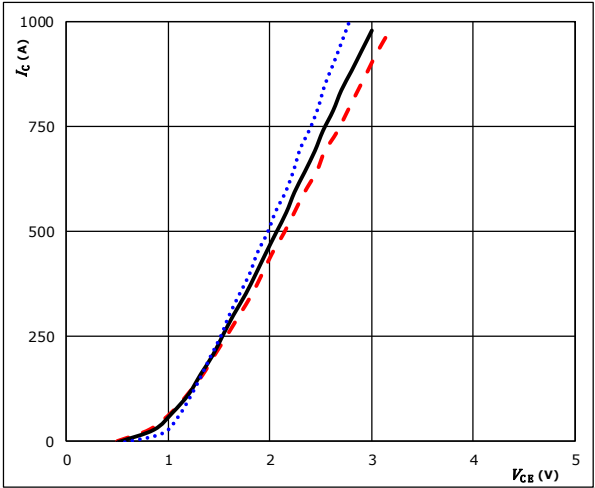

$t_p = 250 \mu\text{s}$
 $V_{CE} = 15 \text{ V}$
 $T_j: 25 \text{ }^\circ\text{C}$ (dotted blue)
 $125 \text{ }^\circ\text{C}$ (solid black)
 $150 \text{ }^\circ\text{C}$ (dashed red)

figure 2. IGBT

Typical output characteristics

$$I_C = f(V_{CE})$$

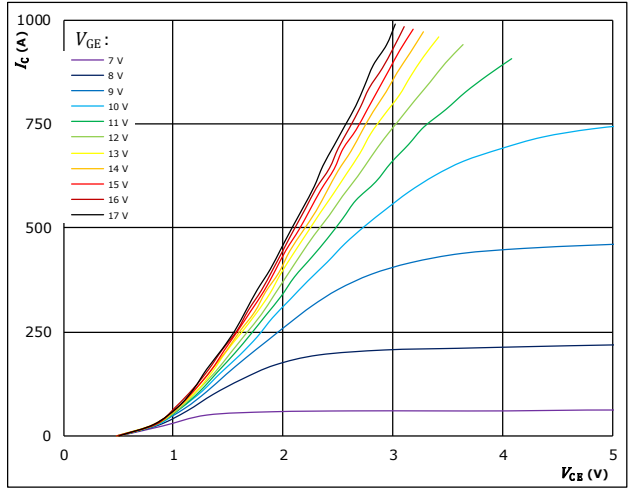

$t_p = 250 \mu\text{s}$
 $T_j = 150 \text{ }^\circ\text{C}$
 V_{GE} from 7 V to 17 V in steps of 1 V

figure 3. IGBT

Typical transfer characteristics

$$I_C = f(V_{GE})$$

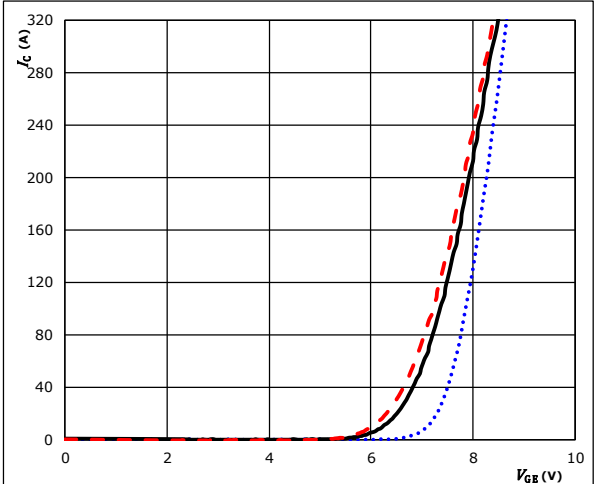

$t_p = 100 \mu\text{s}$
 $V_{CE} = 10 \text{ V}$
 $T_j: 25 \text{ }^\circ\text{C}$ (dotted blue)
 $125 \text{ }^\circ\text{C}$ (solid black)
 $150 \text{ }^\circ\text{C}$ (dashed red)

figure 4. IGBT

Transient thermal impedance as function of pulse duration

$$Z_{th(j-s)} = f(t_p)$$

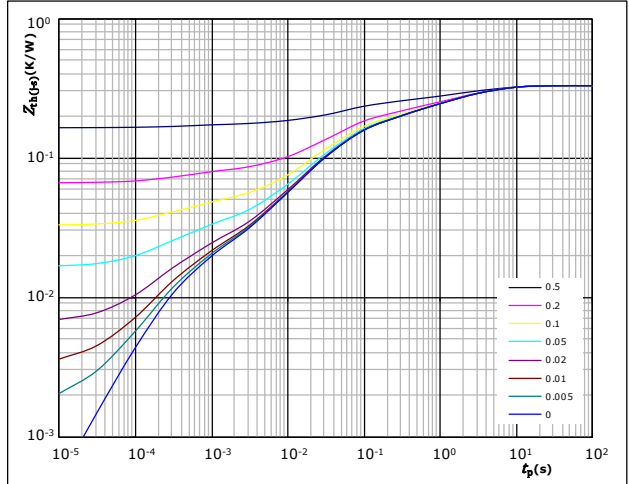

$D = t_p / T$
 $R_{th(j-s)} = 0,33 \text{ K/W}$

IGBT thermal model values

R (K/W)	τ (s)
7,40E-02	4,51E+00
7,65E-02	9,09E-01
5,04E-02	1,46E-01
1,01E-01	3,45E-02
1,34E-02	4,36E-03
1,43E-02	3,37E-04



Buck Switch Characteristics

figure 5. IGBT

Gate voltage vs gate charge

$V_{GE} = f(Q_G)$

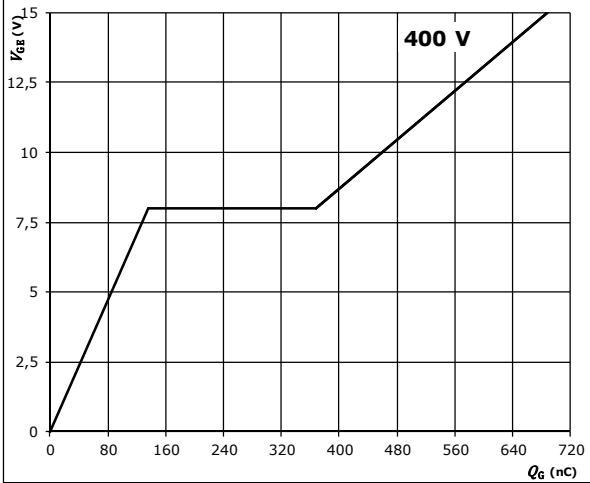

$I_C = 320$ A

figure 6. IGBT

Safe operating area

$I_C = f(V_{CE})$

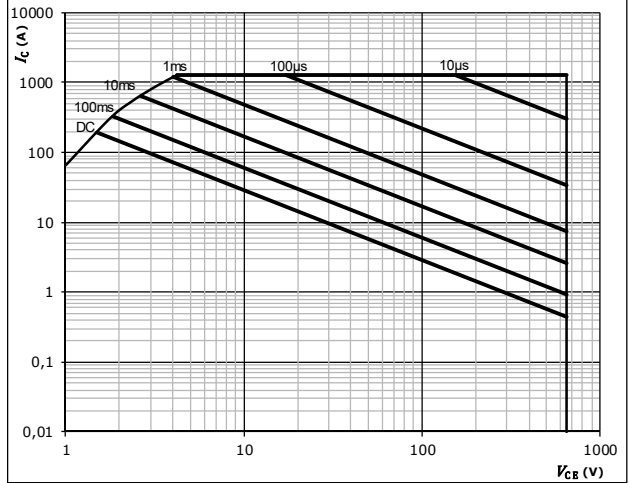

$D =$ single pulse
 $T_s = 80$ °C
 $V_{GE} = \pm 15$ V
 $T_j = T_{jmax}$



Buck Diode Characteristics

figure 1. FWD

Typical forward characteristics

$$I_F = f(V_F)$$

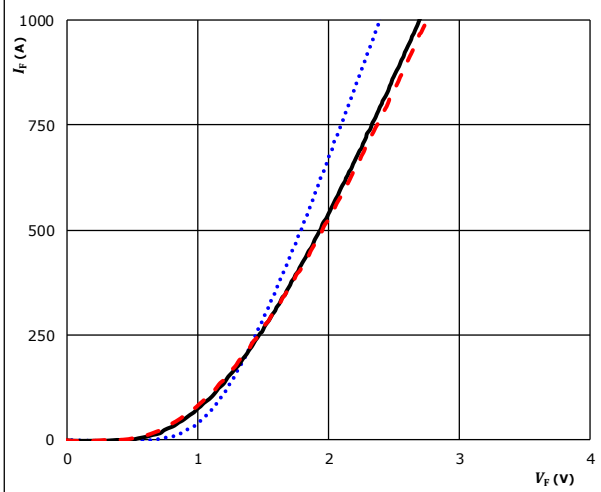

$t_p = 250 \mu s$
 T_j : 25 °C
 125 °C ———
 150 °C - - - -

figure 2. FWD

Transient thermal impedance as a function of pulse width

$$Z_{th(j-s)} = f(t_p)$$

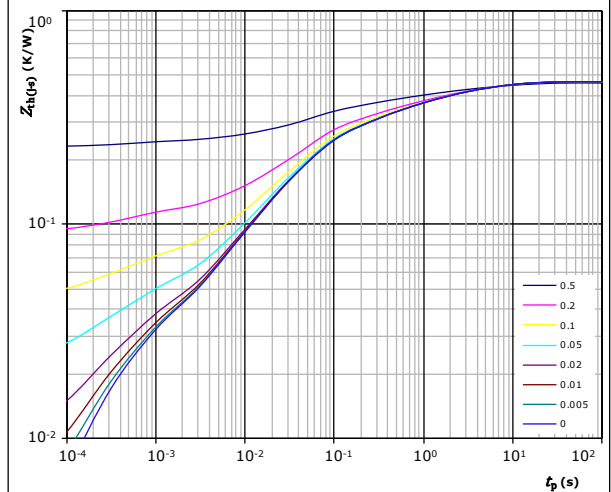

$D = t_p / T$
 $R_{th(j-s)} = 0,46 \text{ K/W}$

FWD thermal model values

R (K/W)	τ (s)
6,31E-02	6,50E+00
8,04E-02	1,31E+00
8,87E-02	2,64E-01
1,65E-01	4,43E-02
3,87E-02	6,98E-03
2,43E-02	3,73E-04



Boost Switch Characteristics

figure 1. IGBT

Typical output characteristics

$I_C = f(V_{CE})$

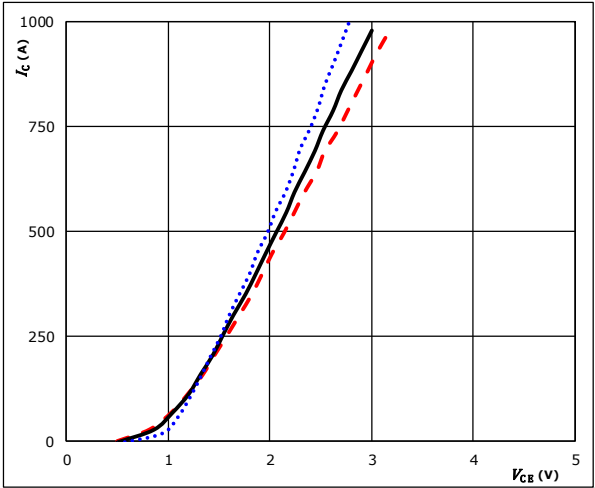

$t_p = 250 \mu s$
 $V_{CE} = 15 V$
 $T_j: 25 \text{ }^\circ C$ (solid black line)
 $125 \text{ }^\circ C$ (dotted blue line)
 $150 \text{ }^\circ C$ (dashed red line)

figure 2. IGBT

Typical output characteristics

$I_C = f(V_{CE})$

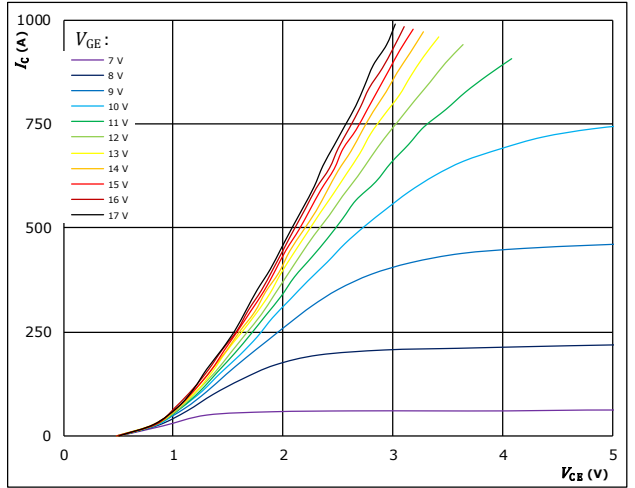

$t_p = 250 \mu s$
 $T_j = 150 \text{ }^\circ C$
 V_{GE} from 7 V to 17 V in steps of 1 V

figure 3. IGBT

Typical transfer characteristics

$I_C = f(V_{GE})$

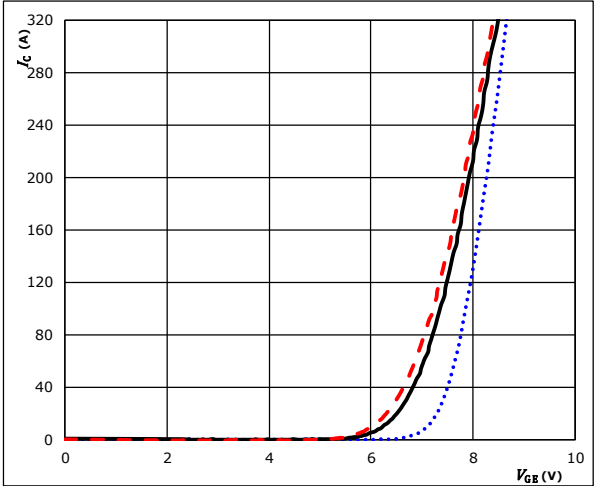

$t_p = 100 \mu s$
 $V_{CE} = 10 V$
 $T_j: 25 \text{ }^\circ C$ (dotted blue line)
 $125 \text{ }^\circ C$ (solid black line)
 $150 \text{ }^\circ C$ (dashed red line)

figure 4. IGBT

Transient thermal impedance as function of pulse duration

$Z_{th(j-s)} = f(t_p)$

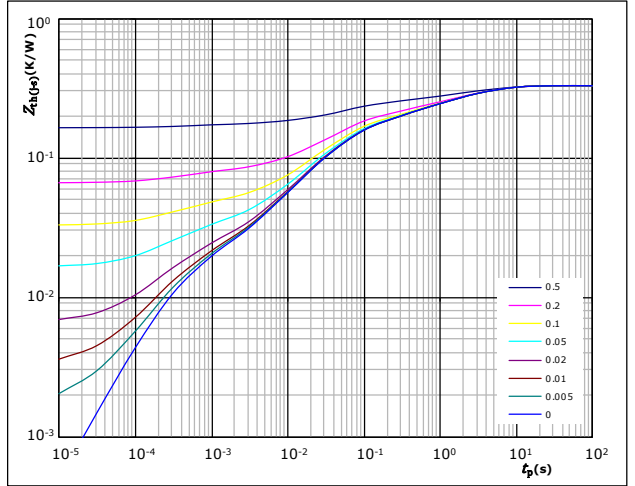

$D = t_p / T$
 $R_{th(j-s)} = 0,33 \text{ K/W}$

IGBT thermal model values

R (K/W)	τ (s)
7,40E-02	4,51E+00
7,65E-02	9,09E-01
5,04E-02	1,46E-01
1,01E-01	3,45E-02
1,34E-02	4,36E-03
1,43E-02	3,37E-04



Boost Switch Characteristics

figure 5. IGBT

Gate voltage vs gate charge

$V_{GE} = f(Q_G)$

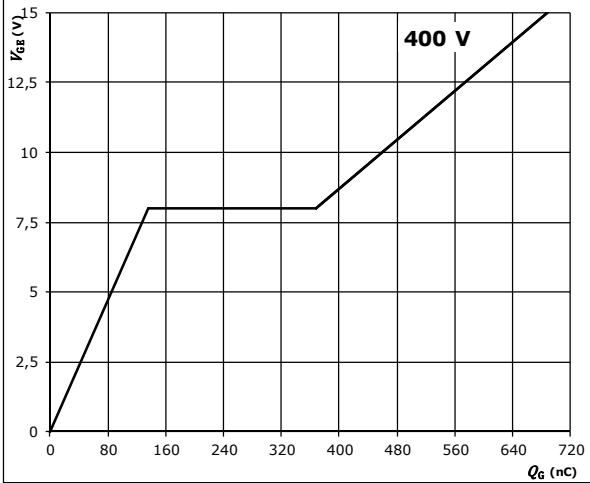

$I_C = 320$ A

figure 6. IGBT

Safe operating area

$I_C = f(V_{CE})$

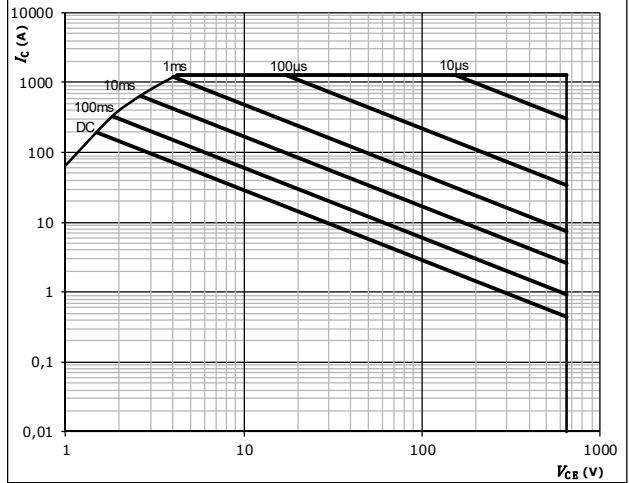

$D =$ single pulse
 $T_s = 80$ °C
 $V_{GE} = \pm 15$ V
 $T_j = T_{jmax}$



Boost Diode Characteristics

figure 1. FWD

Typical forward characteristics

$$I_F = f(V_F)$$

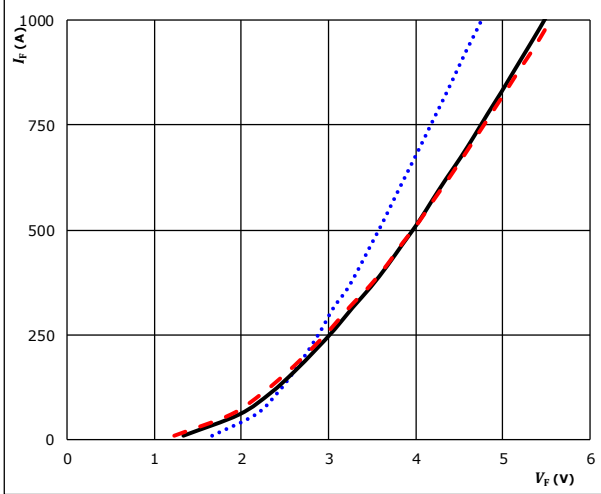

$t_p = 250 \mu s$
 T_j : 25 °C
 125 °C ———
 150 °C - - -

figure 2. FWD

Transient thermal impedance as a function of pulse width

$$Z_{th(j-s)} = f(t_p)$$

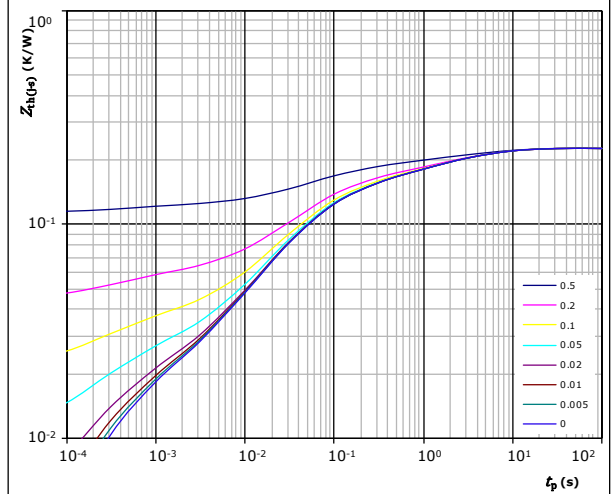

$D = t_p / T$
 $R_{th(j-s)} = 0,23 \text{ K/W}$
 FWD thermal model values

R (K/W)	τ (s)
2,98E-02	6,07E+00
3,97E-02	1,43E+00
4,45E-02	2,09E-01
7,10E-02	4,64E-02
2,25E-02	1,22E-02
6,79E-03	1,76E-03
1,22E-02	2,85E-04



Buck Sw. Protection Diode Characteristics

figure 1. FWD

Typical forward characteristics

$$I_F = f(V_F)$$

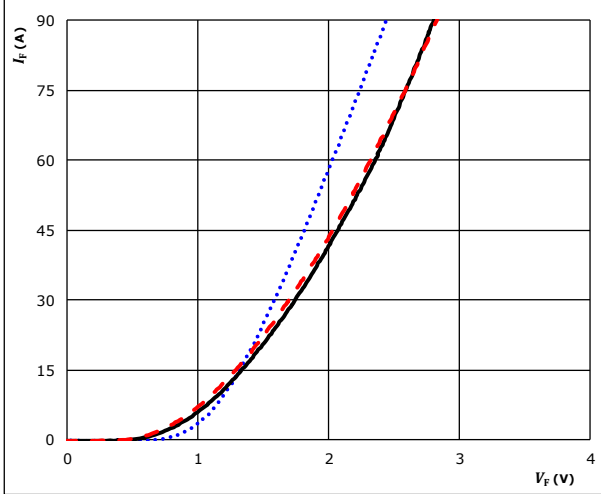

$t_p = 250 \mu s$
 T_j : 25 °C
 125 °C ———
 150 °C - - - -

figure 2. FWD

Transient thermal impedance as a function of pulse width

$$Z_{th(j-s)} = f(t_p)$$

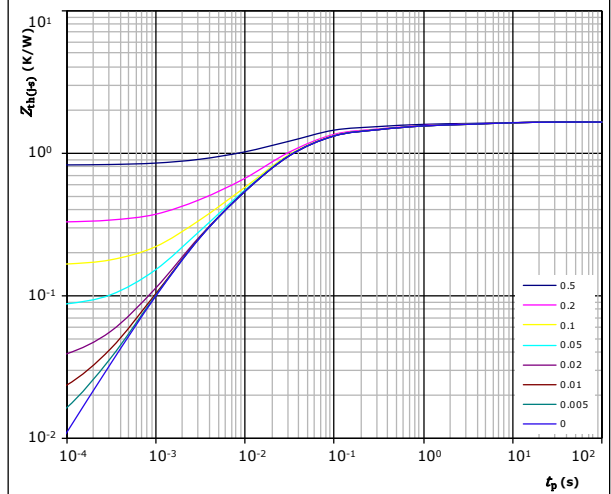

$D = t_p / T$
 $R_{th(j-s)} = 1,63 \text{ K/W}$
 FWD thermal model values

R (K/W)	τ (s)
9,92E-02	5,24E+00
2,09E-01	3,38E-01
2,18E-01	6,29E-02
9,00E-01	2,20E-02
2,06E-01	2,64E-03



Boost Sw. Protection Diode Characteristics

figure 1. FWD

Typical forward characteristics

$$I_F = f(V_F)$$

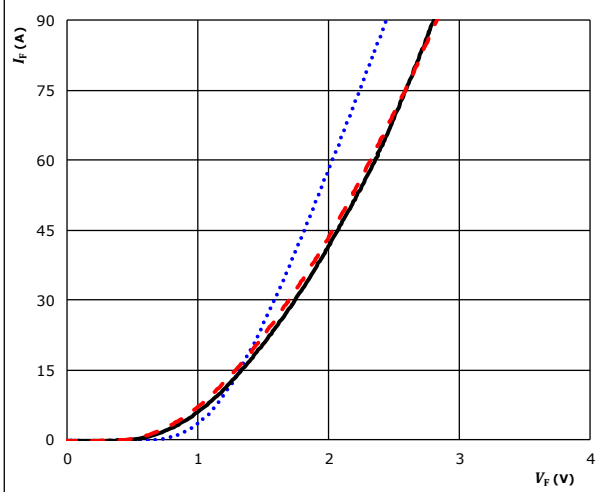

$t_p = 250 \mu s$
 T_j : 25 °C
125 °C ———
150 °C - - -

figure 2. FWD

Transient thermal impedance as a function of pulse width

$$Z_{th(j-s)} = f(t_p)$$

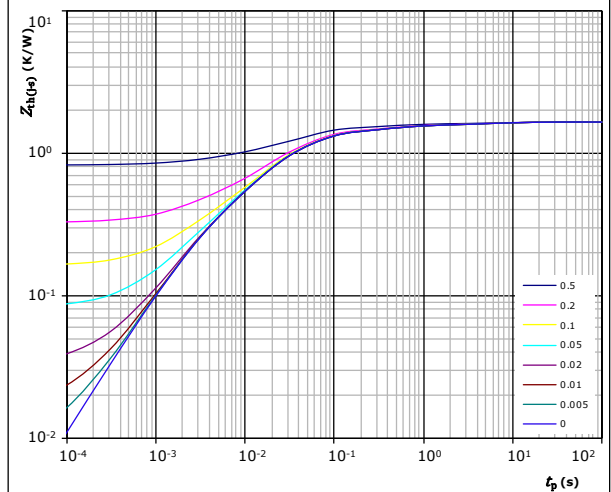

$D = t_p / T$
 $R_{th(j-s)} = 1,63 \text{ K/W}$
FWD thermal model values

R (K/W)	τ (s)
9,92E-02	5,24E+00
2,09E-01	3,38E-01
2,18E-01	6,29E-02
9,00E-01	2,20E-02
2,06E-01	2,64E-03

Thermistor Characteristics

figure 1. Thermistor

Typical NTC characteristic as a function of temperature

$$R = f(T)$$

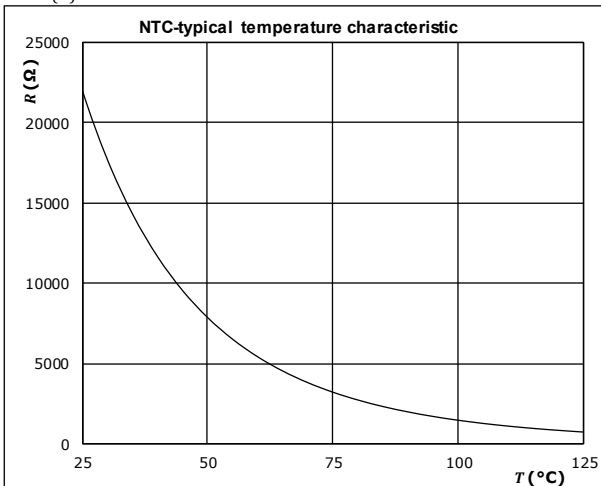



Buck Switching Characteristics

figure 1. IGBT

Typical switching energy losses as a function of collector current

$$E = f(I_c)$$

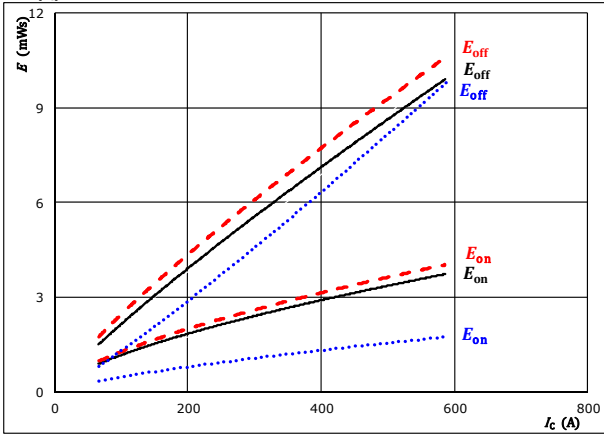

With an inductive load at
 $V_{CE} = 350$ V
 $V_{GE} = \pm 15$ V
 $R_{gon} = 2$ Ω
 $R_{goff} = 2$ Ω
 $T_j: 25$ °C
 125 °C
 150 °C

figure 2. IGBT

Typical switching energy losses as a function of gate resistor

$$E = f(R_g)$$

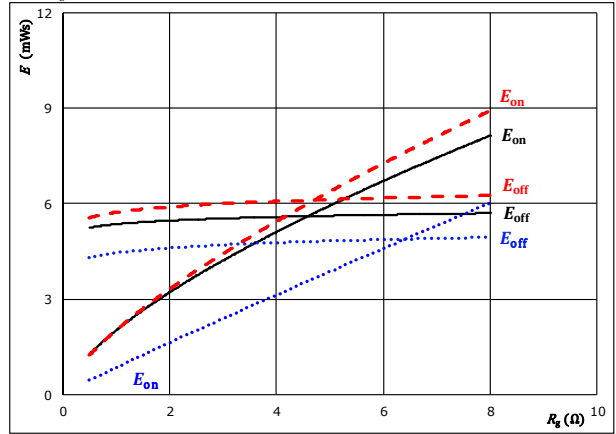

With an inductive load at
 $V_{CE} = 350$ V
 $V_{GE} = \pm 15$ V
 $I_c = 320$ A
 $T_j: 25$ °C
 125 °C
 150 °C

figure 3. FWD

Typical reverse recovered energy loss as a function of collector current

$$E_{rec} = f(I_c)$$

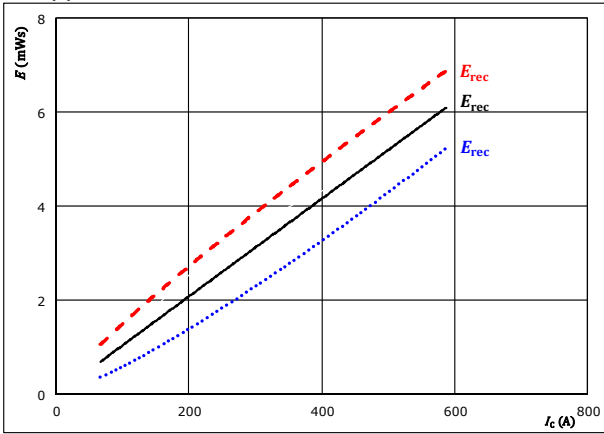

With an inductive load at
 $V_{CE} = 350$ V
 $V_{GE} = \pm 15$ V
 $R_{gon} = 2$ Ω
 $T_j: 25$ °C
 125 °C
 150 °C

figure 4. FWD

Typical reverse recovered energy loss as a function of gate resistor

$$E_{rec} = f(R_g)$$

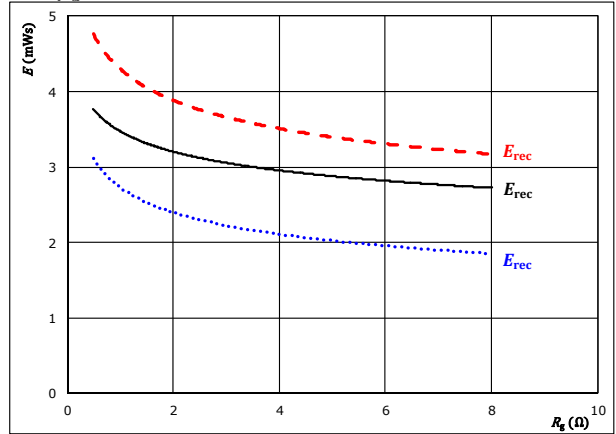

With an inductive load at
 $V_{CE} = 350$ V
 $V_{GE} = \pm 15$ V
 $I_c = 320$ A
 $T_j: 25$ °C
 125 °C
 150 °C



Vincotech

Buck Switching Characteristics

figure 5. IGBT

Typical switching times as a function of collector current

$$t = f(I_C)$$

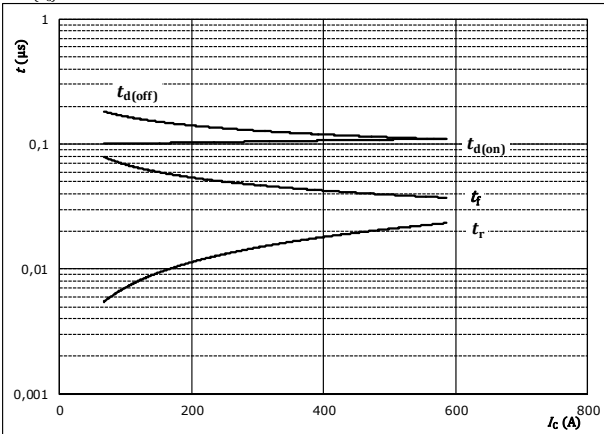

With an inductive load at

$T_j = 150$ °C
 $V_{CE} = 350$ V
 $V_{GE} = \pm 15$ V
 $R_{g(on)} = 2$ Ω
 $R_{g(off)} = 2$ Ω

figure 6. IGBT

Typical switching times as a function of gate resistor

$$t = f(R_g)$$

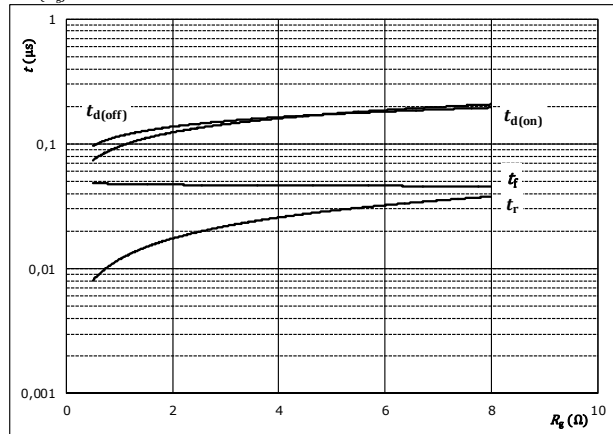

With an inductive load at

$T_j = 150$ °C
 $V_{CE} = 350$ V
 $V_{GE} = \pm 15$ V
 $I_C = 320$ A

figure 7. FWD

Typical reverse recovery time as a function of collector current

$$t_{rr} = f(I_C)$$

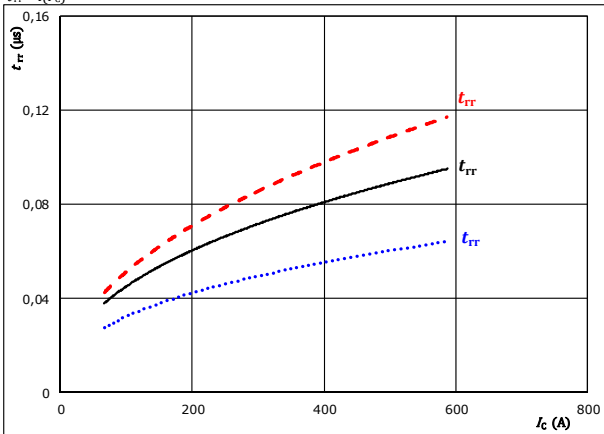

With an inductive load at

$V_{CE} = 350$ V
 $V_{GE} = \pm 15$ V
 $R_{g(on)} = 2$ Ω
 $T_j: 25$ °C (dotted)
 125 °C (solid)
 150 °C (dashed)

figure 8. FWD

Typical reverse recovery time as a function of IGBT turn on gate resistor

$$t_{rr} = f(R_{g(on)})$$

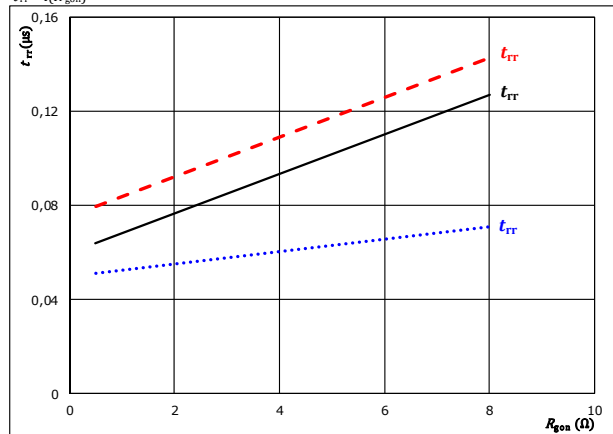

With an inductive load at

$V_{CE} = 350$ V
 $V_{GE} = \pm 15$ V
 $I_C = 320$ A
 $T_j: 25$ °C (dotted)
 125 °C (solid)
 150 °C (dashed)



Buck Switching Characteristics

figure 9. FWD

Typical recovered charge as a function of collector current

$$Q_r = f(I_c)$$

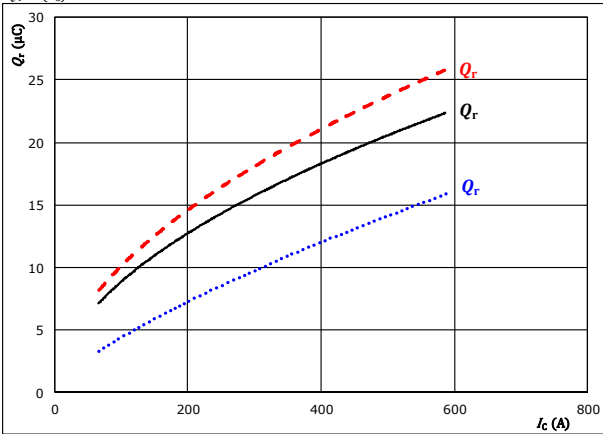

With an inductive load at
 $V_{CE} = 350$ V
 $V_{GE} = \pm 15$ V
 $R_{gon} = 2$ Ω
 T_j : 25 °C (blue dotted), 125 °C (black solid), 150 °C (red dashed)

figure 10. FWD

Typical recovered charge as a function of IGBT turn on gate resistor

$$Q_r = f(R_{gon})$$

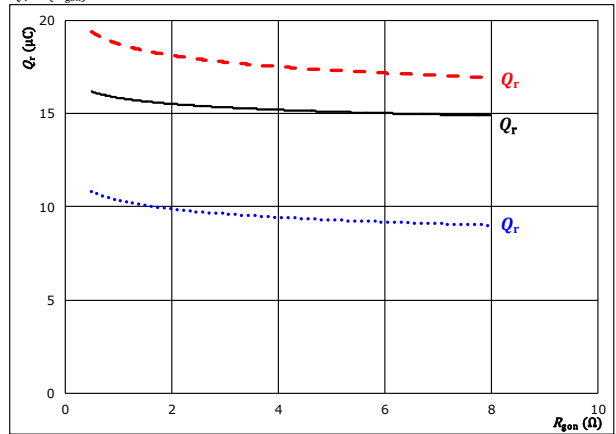

With an inductive load at
 $V_{CE} = 350$ V
 $V_{GE} = \pm 15$ V
 $I_c = 320$ A
 T_j : 25 °C (blue dotted), 125 °C (black solid), 150 °C (red dashed)

figure 11. FWD

Typical peak reverse recovery current current as a function of collector current

$$I_{RM} = f(I_c)$$

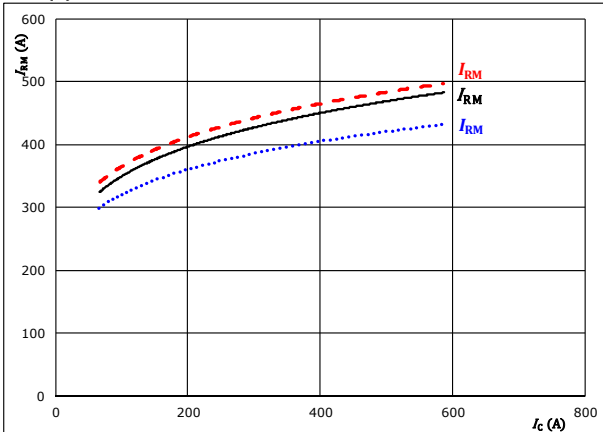

With an inductive load at
 $V_{CE} = 350$ V
 $V_{GE} = \pm 15$ V
 $R_{gon} = 2$ Ω
 T_j : 25 °C (blue dotted), 125 °C (black solid), 150 °C (red dashed)

figure 12. FWD

Typical peak reverse recovery current current as a function of IGBT turn on gate resistor

$$I_{RM} = f(R_{gon})$$

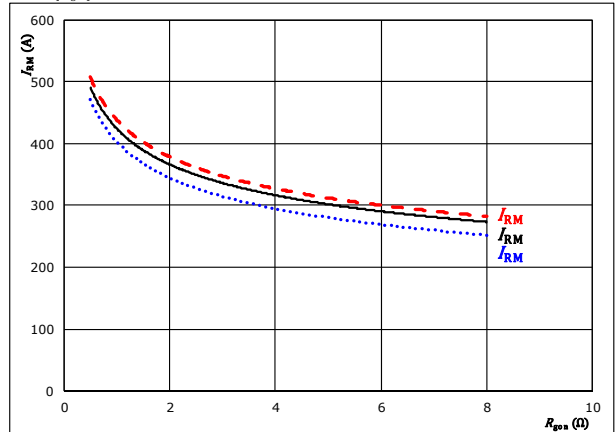

With an inductive load at
 $V_{CE} = 350$ V
 $V_{GE} = \pm 15$ V
 $I_c = 320$ A
 T_j : 25 °C (blue dotted), 125 °C (black solid), 150 °C (red dashed)



Vincotech

Buck Switching Characteristics

figure 13. FWD

Typical rate of fall of forward and reverse recovery current as a function of collector current
 $di_f/dt, di_{rr}/dt = f(I_c)$

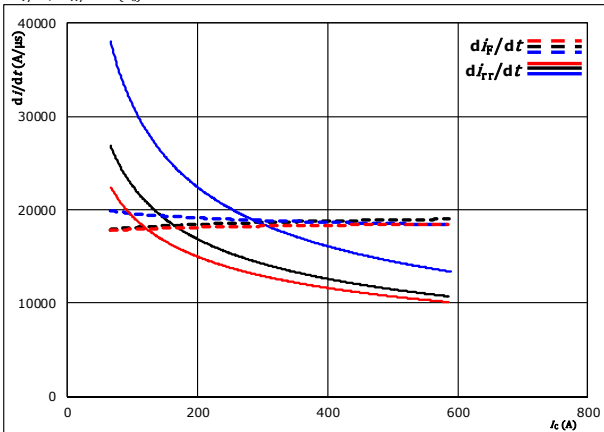

With an inductive load at
 $V_{CE} = 350$ V
 $V_{GE} = \pm 15$ V
 $R_{gon} = 2$ Ω
 $T_j = 25$ °C
 150 °C

figure 14. FWD

Typical rate of fall of forward and reverse recovery current as a function of IGBT turn on gate resistor
 $di_f/dt, di_{rr}/dt = f(R_{gon})$

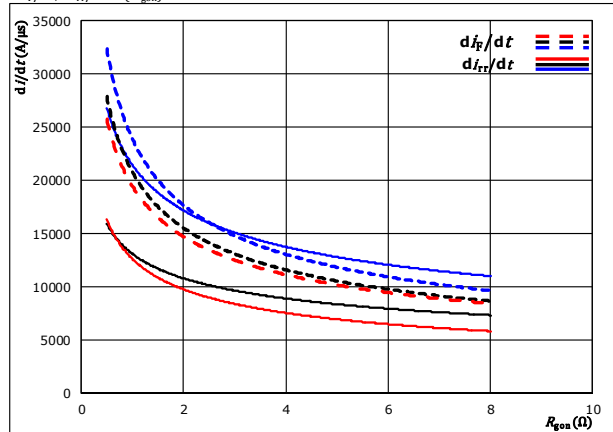

With an inductive load at
 $V_{CE} = 350$ V
 $V_{GE} = \pm 15$ V
 $I_C = 320$ A
 $T_j = 25$ °C
 150 °C

figure 15. IGBT

Reverse bias safe operating area
 $I_C = f(V_{CE})$

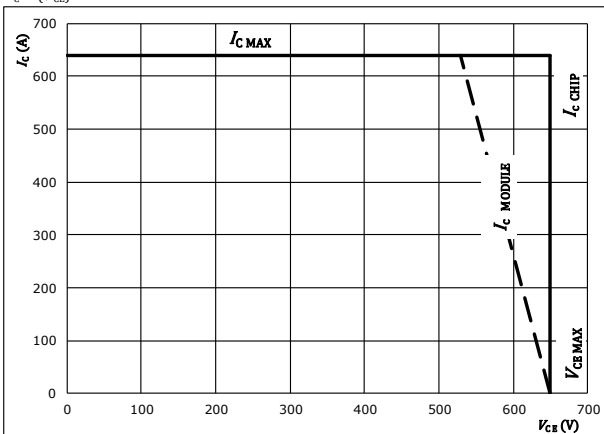

At
 $T_j = 125$ °C
 $R_{gon} = 2$ Ω
 $R_{goff} = 2$ Ω



Buck Switching Definitions

General conditions

T_j	=	125 °C
R_{gon}	=	2 Ω
R_{goff}	=	2 Ω

figure 1. IGBT

Turn-off Switching Waveforms & definition of t_{doff} , t_{Eoff} (t_{Eoff} = integrating time for E_{off})

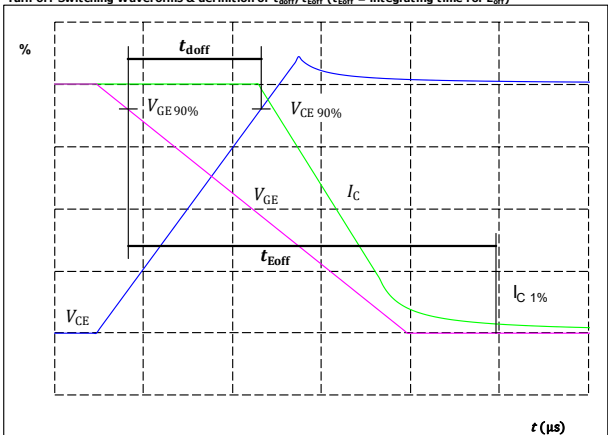

$V_{CE}(0\%) =$	-15	V
$V_{GE}(100\%) =$	15	V
$V_C(100\%) =$	350	V
$I_C(100\%) =$	320	A
$t_{doff} =$	122	ns

figure 2. IGBT

Turn-on Switching Waveforms & definition of t_{don} , t_{Eon} (t_{Eon} = integrating time for E_{on})

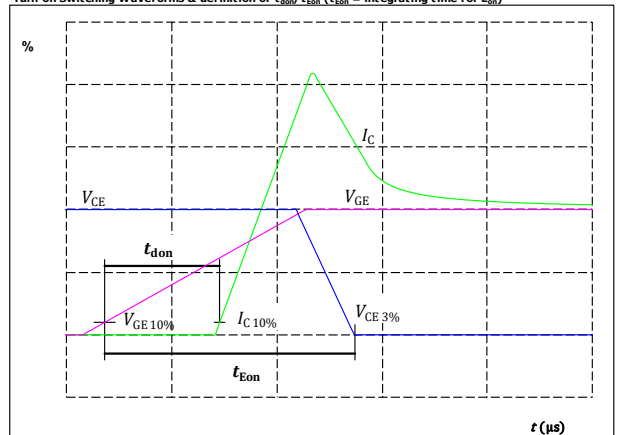

$V_{CE}(0\%) =$	-15	V
$V_{GE}(100\%) =$	15	V
$V_C(100\%) =$	350	V
$I_C(100\%) =$	320	A
$t_{don} =$	107	ns

figure 3. IGBT

Turn-off Switching Waveforms & definition of t_f

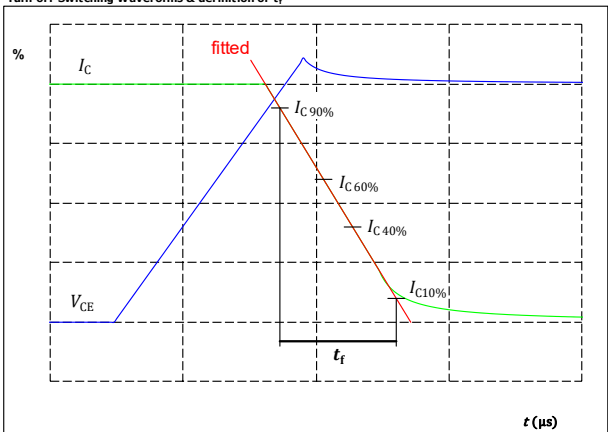

$V_C(100\%) =$	350	V
$I_C(100\%) =$	320	A
$t_f =$	42	ns

figure 4. IGBT

Turn-on Switching Waveforms & definition of t_r

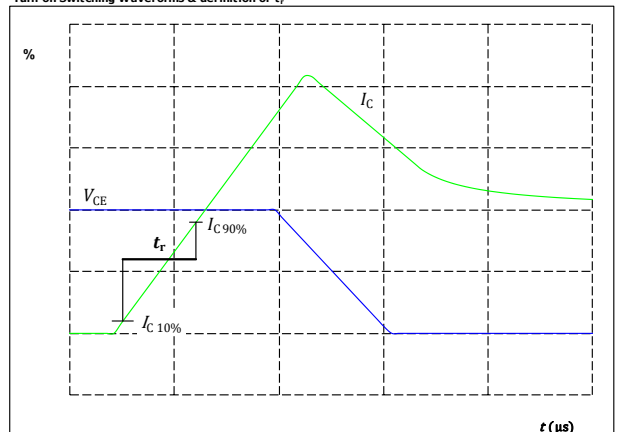

$V_C(100\%) =$	350	V
$I_C(100\%) =$	320	A
$t_r =$	14	ns



Vincotech

Buck Switching Characteristics

figure 5. Turn-off Switching Waveforms & definition of t_{rr} FWD

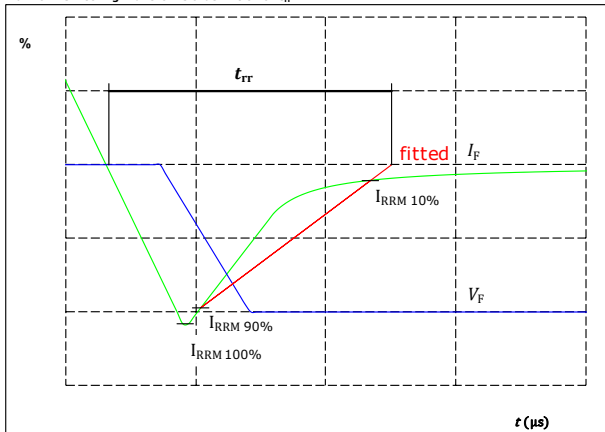

$V_F(100\%) =$	350	V
$I_F(100\%) =$	320	A
$I_{RRM}(100\%) =$	431	A
$t_{rr} =$	69	ns

figure 6. Turn-on Switching Waveforms & definition of t_{Qr} (t_{Qr} = integrating time for Q_r) FWD

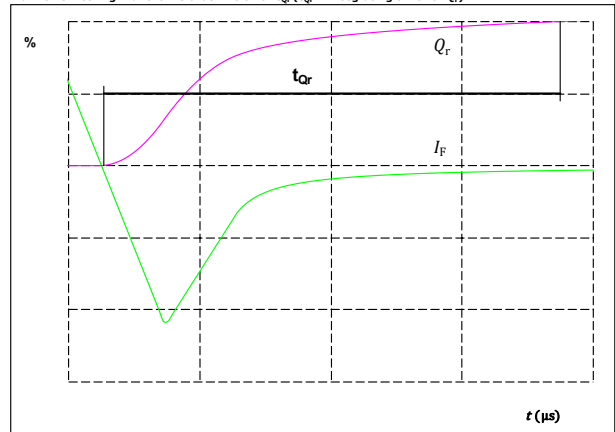

$I_F(100\%) =$	320	A
$Q_r(100\%) =$	0	μC



Boost Switching Characteristics

figure 1. IGBT

Typical switching energy losses as a function of collector current

$$E = f(I_c)$$

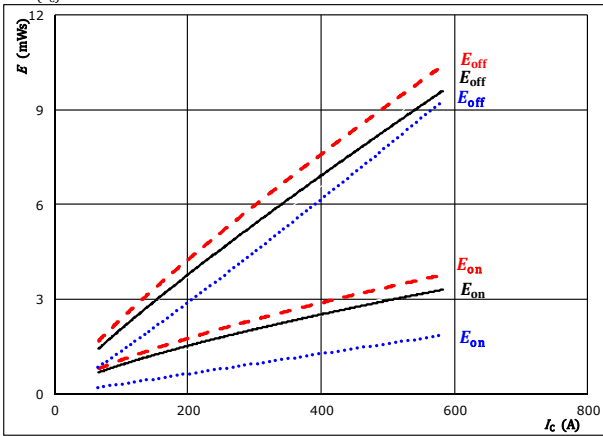

With an inductive load at

$V_{CE} = 350$ V	$T_j: 25$ °C
$V_{GE} = \pm 15$ V	125 °C	————
$R_{g\text{on}} = 2$ Ω	150 °C	-----
$R_{g\text{off}} = 2$ Ω		

figure 2. IGBT

Typical switching energy losses as a function of gate resistor

$$E = f(R_g)$$

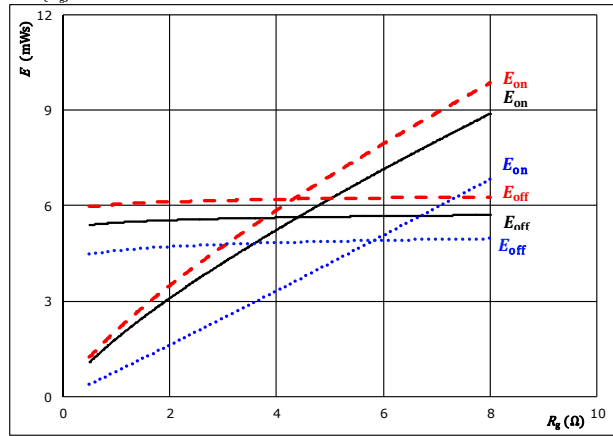

With an inductive load at

$V_{CE} = 350$ V	$T_j: 25$ °C
$V_{GE} = \pm 15$ V	125 °C	————
$I_c = 320$ A	150 °C	-----

figure 3. FWD

Typical reverse recovered energy loss as a function of collector current

$$E_{rec} = f(I_c)$$

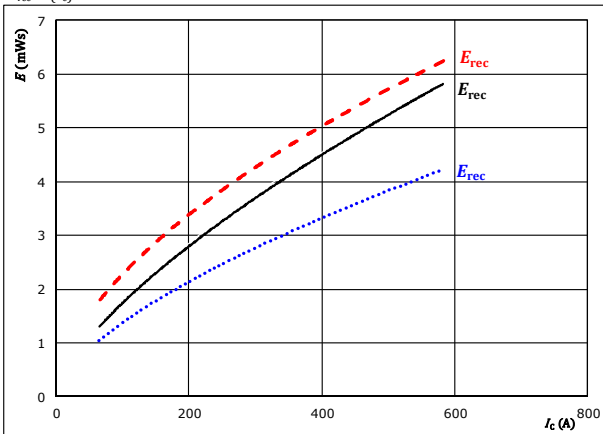

With an inductive load at

$V_{CE} = 350$ V	$T_j: 25$ °C
$V_{GE} = \pm 15$ V	125 °C	————
$R_{g\text{on}} = 2$ Ω	150 °C	-----

figure 4. FWD

Typical reverse recovered energy loss as a function of gate resistor

$$E_{rec} = f(R_g)$$

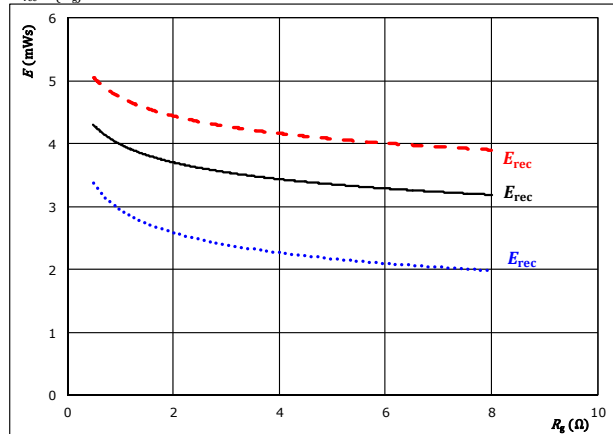

With an inductive load at

$V_{CE} = 350$ V	$T_j: 25$ °C
$V_{GE} = \pm 15$ V	125 °C	————
$I_c = 320$ A	150 °C	-----



Vincotech

Boost Switching Characteristics

figure 5. IGBT

Typical switching times as a function of collector current

$$t = f(I_C)$$

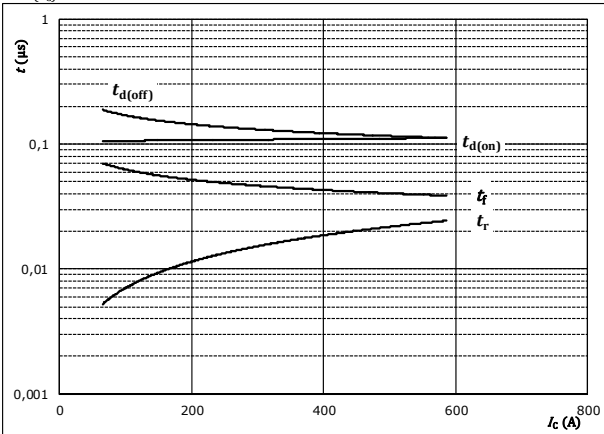

With an inductive load at

$T_j = 150$ °C
 $V_{CE} = 350$ V
 $V_{GE} = \pm 15$ V
 $R_{g\text{on}} = 2$ Ω
 $R_{g\text{off}} = 2$ Ω

figure 6. IGBT

Typical switching times as a function of gate resistor

$$t = f(R_g)$$

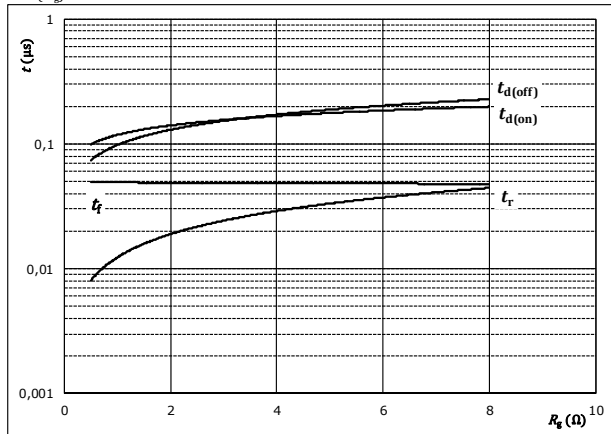

With an inductive load at

$T_j = 150$ °C
 $V_{CE} = 350$ V
 $V_{GE} = \pm 15$ V
 $I_C = 320$ A

figure 7. FWD

Typical reverse recovery time as a function of collector current

$$t_{rr} = f(I_C)$$

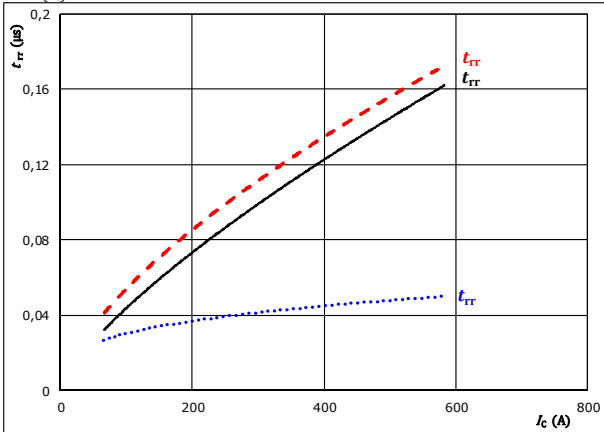

With an inductive load at

$V_{CE} = 350$ V
 $V_{GE} = \pm 15$ V
 $R_{g\text{on}} = 2$ Ω
 $T_j: 25$ °C (dotted)
 125 °C (solid)
 150 °C (dashed)

figure 8. FWD

Typical reverse recovery time as a function of IGBT turn on gate resistor

$$t_{rr} = f(R_{g\text{on}})$$

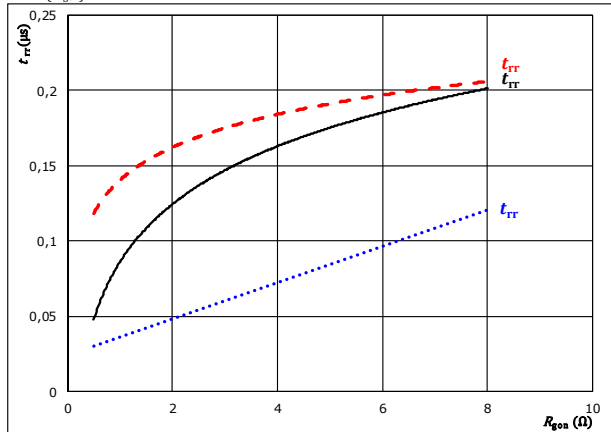

With an inductive load at

$V_{CE} = 350$ V
 $V_{GE} = \pm 15$ V
 $I_C = 320$ A
 $T_j: 25$ °C (dotted)
 125 °C (solid)
 150 °C (dashed)



Boost Switching Characteristics

figure 9. FWD

Typical recovered charge as a function of collector current

$$Q_r = f(I_c)$$

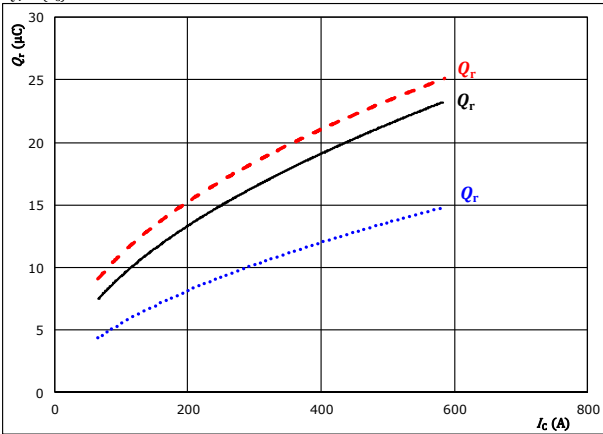

With an inductive load at
 $V_{CE} = 350$ V
 $V_{GE} = \pm 15$ V
 $R_{gon} = 2$ Ω
 T_j : 25 °C (blue dotted), 125 °C (black solid), 150 °C (red dashed)

figure 10. FWD

Typical recovered charge as a function of IGBT turn on gate resistor

$$Q_r = f(R_{gon})$$

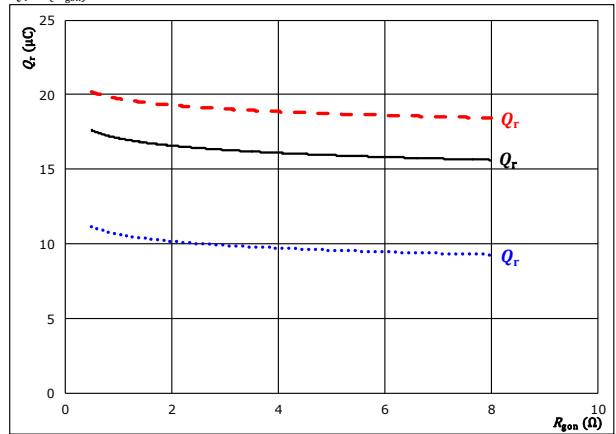

With an inductive load at
 $V_{CE} = 350$ V
 $V_{GE} = \pm 15$ V
 $I_c = 320$ A
 T_j : 25 °C (blue dotted), 125 °C (black solid), 150 °C (red dashed)

figure 11. FWD

Typical peak reverse recovery current current as a function of collector current

$$I_{RM} = f(I_c)$$

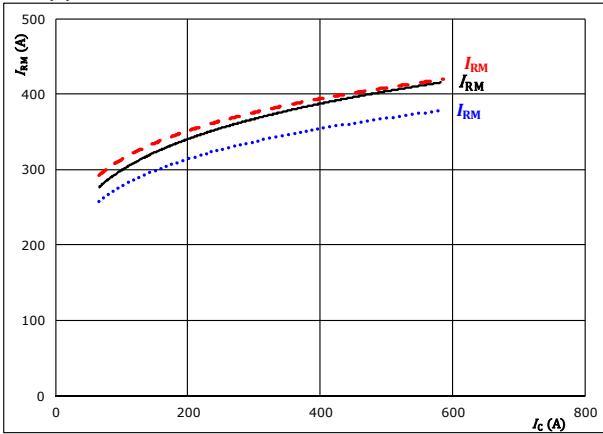

With an inductive load at
 $V_{CE} = 350$ V
 $V_{GE} = \pm 15$ V
 $R_{gon} = 2$ Ω
 T_j : 25 °C (blue dotted), 125 °C (black solid), 150 °C (red dashed)

figure 12. FWD

Typical peak reverse recovery current current as a function of IGBT turn on gate resistor

$$I_{RM} = f(R_{gon})$$

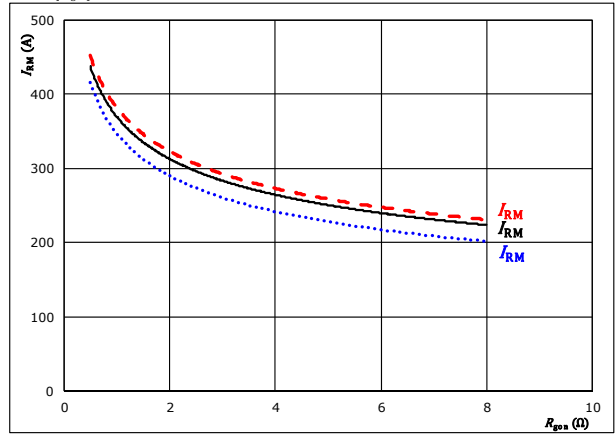

With an inductive load at
 $V_{CE} = 350$ V
 $V_{GE} = \pm 15$ V
 $I_c = 320$ A
 T_j : 25 °C (blue dotted), 125 °C (black solid), 150 °C (red dashed)



Vincotech

Boost Switching Characteristics

figure 13. FWD

Typical rate of fall of forward and reverse recovery current as a function of collector current
 $di_f/dt, di_{rr}/dt = f(I_c)$

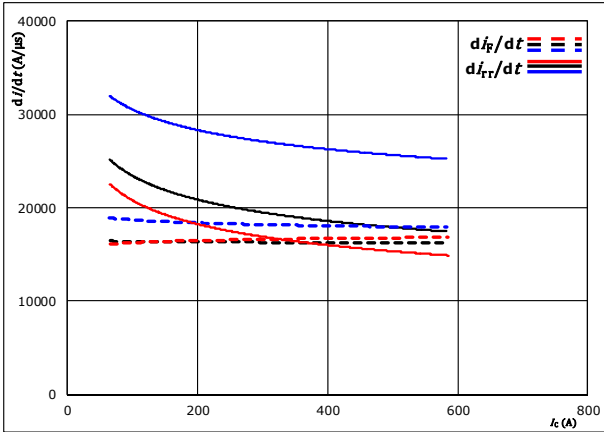

With an inductive load at
 $V_{CE} = 350$ V
 $V_{GE} = \pm 15$ V
 $R_{gon} = 2$ Ω
 $T_j: 125$ °C
 150 °C

figure 14. FWD

Typical rate of fall of forward and reverse recovery current as a function of IGBT turn on gate resistor
 $di_f/dt, di_{rr}/dt = f(R_{gon})$

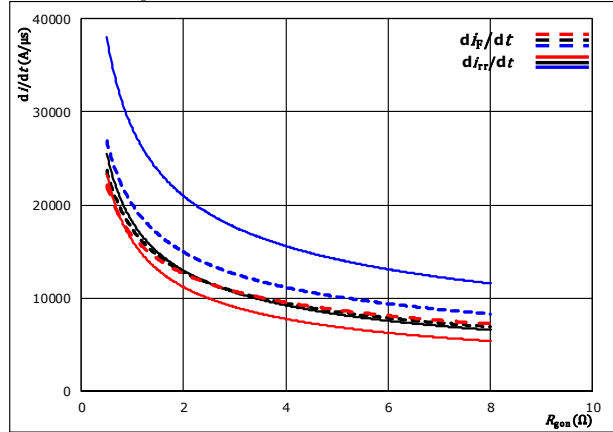

With an inductive load at
 $V_{CE} = 350$ V
 $V_{GE} = \pm 15$ V
 $I_C = 320$ A
 $T_j: 125$ °C
 150 °C

figure 15. IGBT

Reverse bias safe operating area
 $I_C = f(V_{CE})$

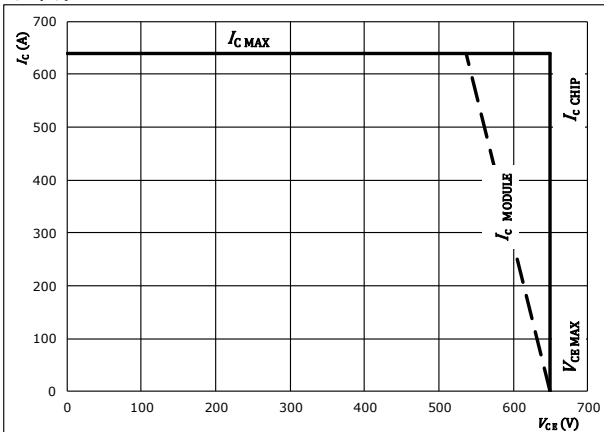

At
 $T_j = 125$ °C
 $R_{gon} = 2$ Ω
 $R_{goff} = 2$ Ω



Boost Switching Definitions

General conditions		
T_j	=	125 °C
R_{gon}	=	2 Ω
R_{goff}	=	2 Ω

figure 1. IGBT

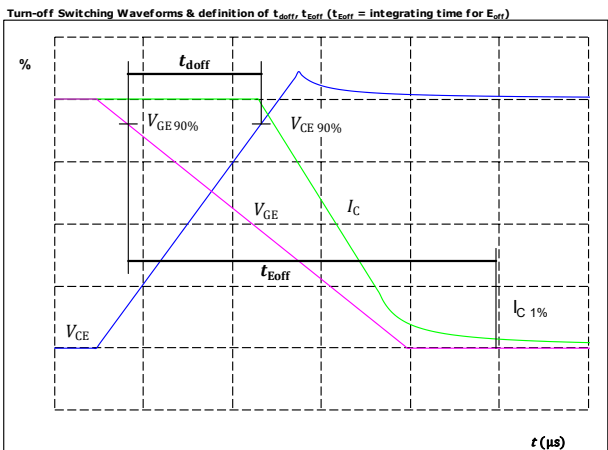

$V_{CE}(0\%) =$	-15	V
$V_{GE}(100\%) =$	15	V
$V_C(100\%) =$	350	V
$I_C(100\%) =$	320	A
$t_{doff} =$	124	ns

figure 2. IGBT

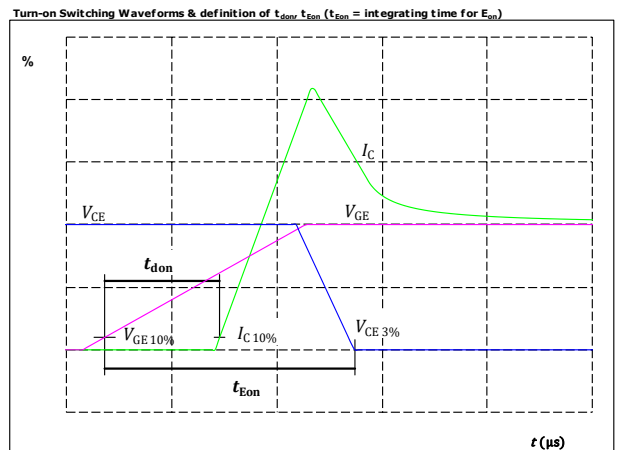

$V_{CE}(0\%) =$	-15	V
$V_{GE}(100\%) =$	15	V
$V_C(100\%) =$	350	V
$I_C(100\%) =$	320	A
$t_{don} =$	111	ns

figure 3. IGBT

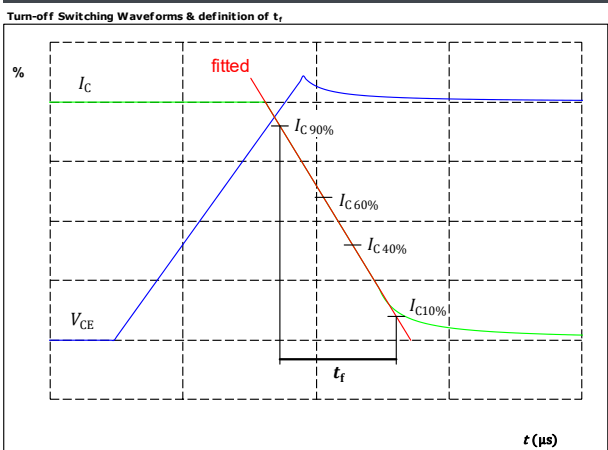

$V_C(100\%) =$	350	V
$I_C(100\%) =$	320	A
$t_f =$	43	ns

figure 4. IGBT

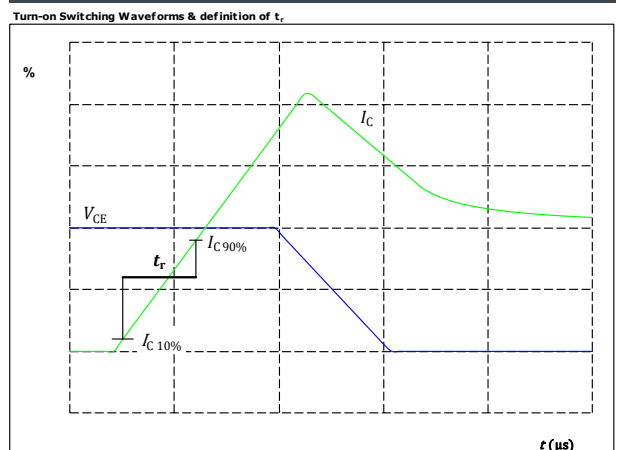

$V_C(100\%) =$	350	V
$I_C(100\%) =$	320	A
$t_r =$	14	ns



Vincotech

Boost Switching Characteristics

figure 5. FWD
Turn-off Switching Waveforms & definition of t_{rr}

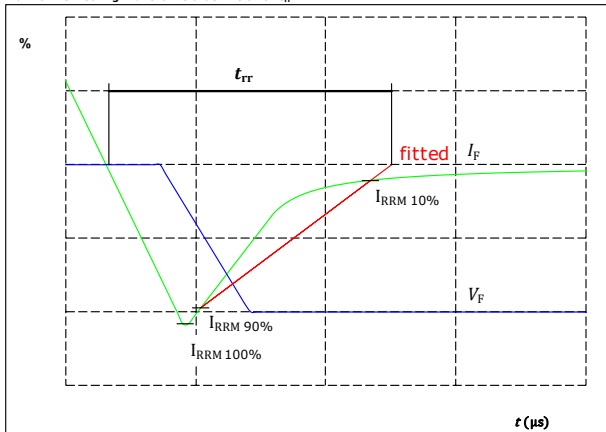

$V_F(100\%) =$	350	V
$I_F(100\%) =$	320	A
$I_{RRM}(100\%) =$	368	A
$t_{rr} =$	131	ns

figure 6. FWD
Turn-on Switching Waveforms & definition of t_{Qr} (t_{Qr} = integrating time for Q_r)

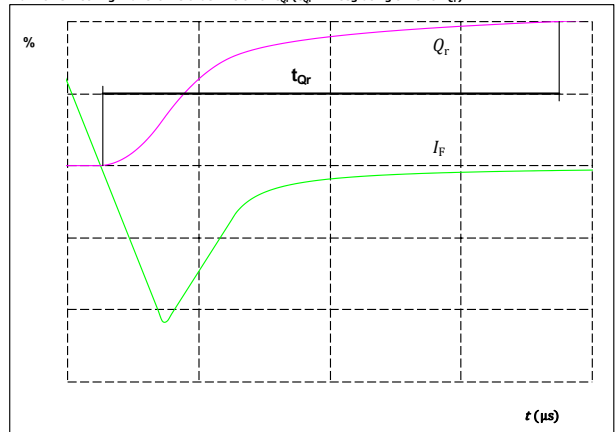

$I_F(100\%) =$	320	A
$Q_r(100\%) =$	0	μC



30-PT07NIA320RV-LE06F68Y / 30-FT07NIA320RV-LE06F68

datasheet

Vincotech

Ordering Code & Marking								
Version			Ordering Code					
without thermal paste 13 mm housing with pressfit pins			30-PT07NIA320RV-LE06F68Y					
without thermal paste 13 mm housing with solder pins			30-FT07NIA320RV-LE06F68					
with thermal paste 13 mm housing with pressfit pins			30-PT07NIA320RV-LE06F68Y-/3/					
with thermal paste 13 mm housing with solder pins			30-FT07NIA320RV-LE06F68-/3/					
NN-NNNNNNNNNNNN TTTTWW WWYY UL VIN LLLL SSSS			Text	Name	Date code	UL & VIN	Lot	Serial
				NN-NNNNNNNNNNNN-TTTTWW	WWYY	UL VIN	LLLL	SSSS
			Datamatrix	Type&Ver	Lot number	Serial	Date code	
			TTTTTWW	LLLL	SSSS	WWYY		

Outline							
Pin table				Pin table			
Pin	X	Y	Function	Pin	X	Y	Function
1	70	6	DC+2	48	50,5	36	Ph2
2	70	3	DC+2	49	64,2	36,6	Therm1
3	70	0	DC+2	50	70,6	36,55	Therm2
4	67,5	3	DC+2	51	45,7	24,05	S13
5	67,5	0	DC+2	52	48,7	24,05	G13
6	65	0	DC+2	53	59,2	22	S11
7	57,75	0	GND2	54	62,2	22	G11
8	55,25	0	GND2				
9	52,75	0	GND2				
10	50,25	0	GND2				
11	43	3	DC-2				
12	43	0	DC-2				
13	40,5	3	DC-2				
14	40,5	0	DC-2				
15	38	3	DC-2				
16	38	0	DC-2				
17	32	3	DC-1				
18	32	0	DC-1				
19	29,5	3	DC-1				
20	29,5	0	DC-1				
21	27	3	DC-1				
22	27	0	DC-1				
23	19,75	0	GND1				
24	17,25	0	GND1				
25	14,75	0	GND1				
26	12,25	0	GND1				
27	5	3	DC+1				
28	5	0	DC+1				
29	2,5	3	DC+1				
30	2,5	0	DC+1				
31	0	3	DC+1				
32	0	0	DC+1				
33	32,25	23,55	S12				
34	29,25	23,55	G12				
35	19,95	23,95	S14				
36	16,95	25,55	G14				
37	2	36	Ph1				
38	4,5	36	Ph1				
39	7	36	Ph1				
40	9,5	36	Ph1				
41	12	36	Ph1				
42	14,5	36	Ph1				
43	38	36	Ph2				
44	40,5	36	Ph2				
45	43	36	Ph2				
46	45,5	36	Ph2				
47	48	36	Ph2				

center of press-fit pinhead
for connection parameter see the handling instruction

Tolerance of positions: ±0.1mm at the end of pins
Dimension of coordinate axis is only offset without tolerance



Vincotech

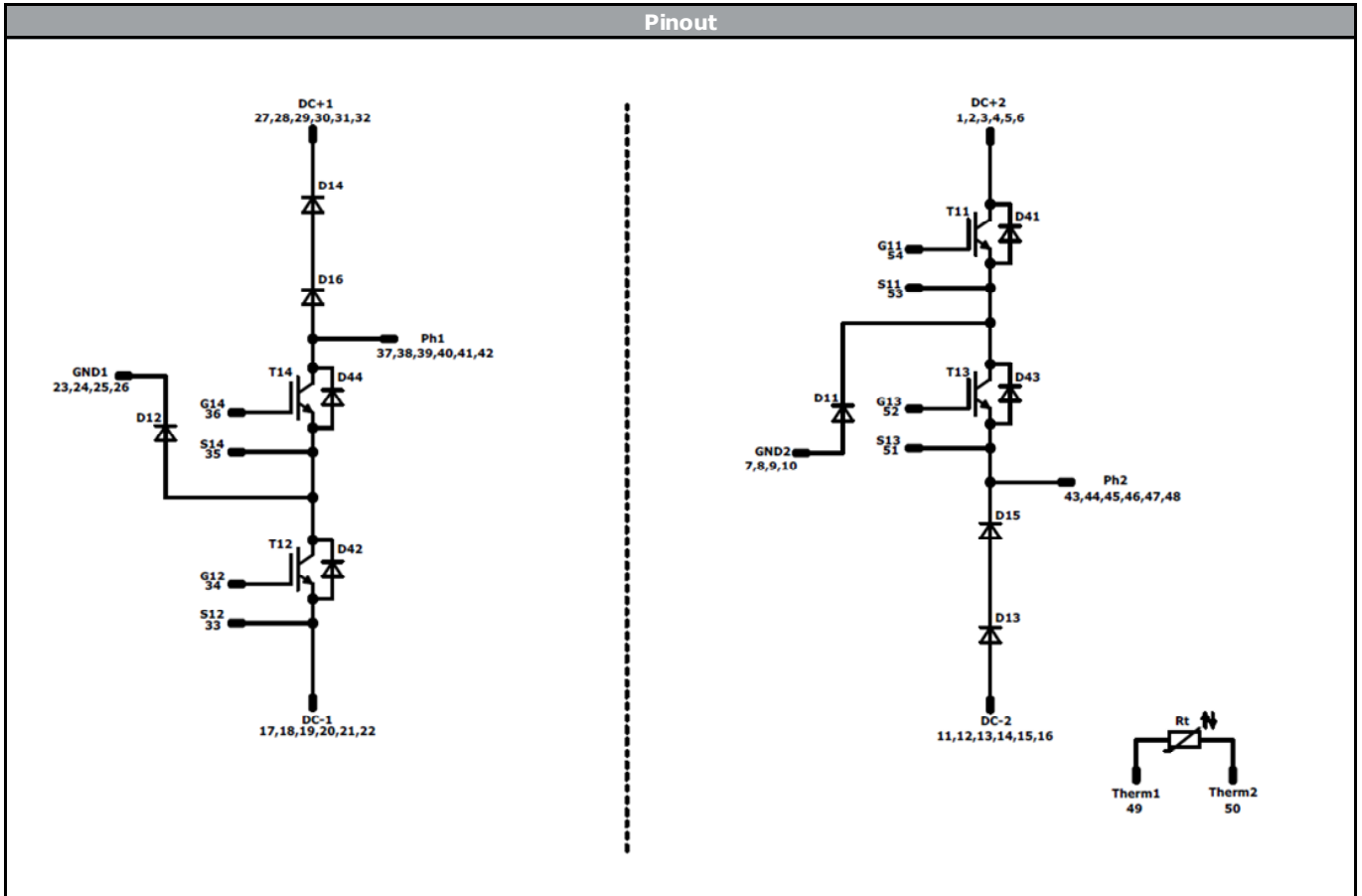

Identification					
ID	Component	Voltage	Current	Function	Comment
T11, T12	IGBT	650 V	320 A	Buck Switch	
D11, D12	FWD	650 V	320 A	Buck Diode	
T13, T14	IGBT	650 V	320 A	Boost Switch	
D13, D15; D14, D16	FWD	1300 V	320 A	Boost Diode	Serial devices. Values apply to complete device.
D41, D42	FWD	650 V	30 A	Buck Sw. Protection Diode	
D43, D44	FWD	650 V	30 A	Boost Sw. Protection Diode	
Rt	Thermistor			Thermistor	



Packaging instruction			
Standard packaging quantity (SPQ) 36	>SPQ	Standard	<SPQ Sample

Handling instruction
Handling instructions for <i>flow 2</i> packages see vincotech.com website.

Package data
Package data for <i>flow 2</i> packages see vincotech.com website.

UL recognition and file number
This device is certified according to UL 1557 standard, UL file number E192116. For more information see vincotech.com website. 

Document No.:	Date:	Modification:	Pages
30-XT07NIA320RV-LE06F68x-D1-14	22 Jan. 2019		

DISCLAIMER

The information, specifications, procedures, methods and recommendations herein (together "information") are presented by Vincotech to reader in good faith, are believed to be accurate and reliable, but may well be incomplete and/or not applicable to all conditions or situations that may exist or occur. Vincotech reserves the right to make any changes without further notice to any products to improve reliability, function or design. No representation, guarantee or warranty is made to reader as to the accuracy, reliability or completeness of said information or that the application or use of any of the same will avoid hazards, accidents, losses, damages or injury of any kind to persons or property or that the same will not infringe third parties rights or give desired results. It is reader's sole responsibility to test and determine the suitability of the information and the product for reader's intended use.

LIFE SUPPORT POLICY

Vincotech products are not authorised for use as critical components in life support devices or systems without the express written approval of Vincotech.

As used herein:

1. Life support devices or systems are devices or systems which, (a) are intended for surgical implant into the body, or (b) support or sustain life, or (c) whose failure to perform when properly used in accordance with instructions for use provided in labelling can be reasonably expected to result in significant injury to the user.
2. A critical component is any component of a life support device or system whose failure to perform can be reasonably expected to cause the failure of the life support device or system, or to affect its safety or effectiveness.

单击下面可查看定价，库存，交付和生命周期等信息

[>>Vincotech\(威科\)](#)