

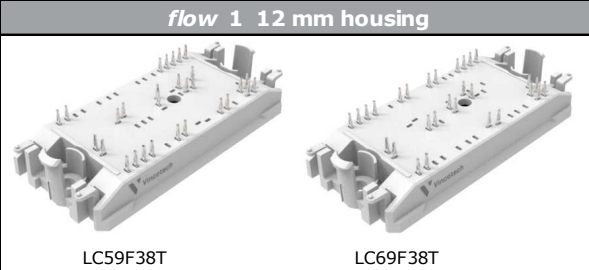
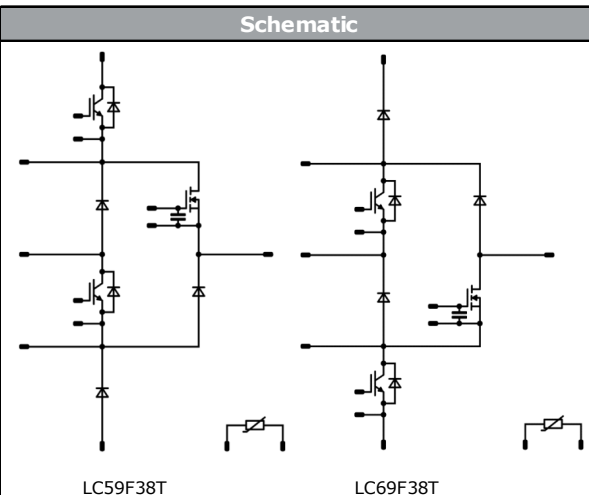

Vincotech

10-PH12NAB008MR02-LC59F38T
10-PH12NAC008MR02-LC69F38T
 target datasheet

<i>flow ANPC 1 split</i>	1200 V / 8 mΩ
<div style="border: 1px solid black; padding: 5px; margin-bottom: 10px;"> <p style="text-align: center; background-color: #cccccc; margin: 0;">Features</p> <ul style="list-style-type: none"> Split Advanced NPC topology Ultra-high switching frequency with SiC MOSFETs Split topology for better thermal performance No x-conduction at high frequencies </div> <div style="border: 1px solid black; padding: 5px; margin-bottom: 10px;"> <p style="text-align: center; background-color: #cccccc; margin: 0;">Target applications</p> <ul style="list-style-type: none"> Solar Inverter </div> <div style="border: 1px solid black; padding: 5px;"> <p style="text-align: center; background-color: #cccccc; margin: 0;">Types</p> <ul style="list-style-type: none"> 10-PH12NAB008MR02-LC59F38T 10-PH12NAC008MR02-LC69F38T </div>	<div style="border: 1px solid black; padding: 5px; margin-bottom: 10px;"> <p style="text-align: center; background-color: #cccccc; margin: 0;"><i>flow 1 12 mm housing</i></p>  <p style="display: flex; justify-content: space-around; font-size: small;"> LC59F38T LC69F38T </p> </div> <div style="border: 1px solid black; padding: 5px;"> <p style="text-align: center; background-color: #cccccc; margin: 0;">Schematic</p>  <p style="display: flex; justify-content: space-around; font-size: small;"> LC59F38T LC69F38T </p> </div>

Maximum Ratings

$T_j = 25\text{ °C}$, unless otherwise specified

Parameter	Symbol	Condition	Value	Unit
DC-Link Switch				
Collector-emitter voltage	V_{CES}		1200	V
Collector current	I_C	$T_j = T_{jmax}$ $T_s = 80\text{ °C}$	123	A
Repetitive peak collector current	I_{CRM}	t_p limited by T_{jmax}	300	A
Total power dissipation	P_{tot}	$T_j = T_{jmax}$ $T_s = 80\text{ °C}$	232	W
Gate-emitter voltage	V_{GES}		±20	V
Maximum junction temperature	T_{jmax}		175	°C



Vincotech

10-PH12NAB008MR02-LC59F38T
10-PH12NAC008MR02-LC69F38T
 target datasheet

Maximum Ratings

$T_j = 25\text{ °C}$, unless otherwise specified

Parameter	Symbol	Condition	Value	Unit
-----------	--------	-----------	-------	------

DC-Link Diode

Peak repetitive reverse voltage	V_{RRM}		1200	V
Continuous (direct) forward current	I_F	$T_j = T_{jmax}$ $T_s = 80\text{ °C}$	72	A
Repetitive peak forward current	I_{FRM}		200	A
Total power dissipation	P_{tot}	$T_j = T_{jmax}$ $T_s = 80\text{ °C}$	121	W
Maximum junction temperature	T_{jmax}		175	°C

DC-Link Switch Inverse Diode

Peak repetitive reverse voltage	V_{RRM}		1200	V
Continuous (direct) forward current	I_F	$T_j = T_{jmax}$ $T_s = 80\text{ °C}$	72	A
Repetitive peak forward current	I_{FRM}		200	A
Total power dissipation	P_{tot}	$T_j = T_{jmax}$ $T_s = 80\text{ °C}$	121	W
Maximum junction temperature	T_{jmax}		175	°C

Neutral Point Switch

Collector-emitter voltage	V_{CES}		1200	V
Collector current	I_C	$T_j = T_{jmax}$ $T_s = 80\text{ °C}$	123	A
Repetitive peak collector current	I_{CRM}	t_p limited by T_{jmax}	300	A
Total power dissipation	P_{tot}	$T_j = T_{jmax}$ $T_s = 80\text{ °C}$	232	W
Gate-emitter voltage	V_{GES}		±20	V
Maximum junction temperature	T_{jmax}		175	°C

Neutral Point Diode

Peak Repetitive Reverse Voltage	V_{RRM}		1200	V
Continuous (direct) forward current	I_F	$T_j = T_{jmax}$ $T_s = 80\text{ °C}$	97	A
Repetitive peak forward current	I_{FRM}		300	A
Total power dissipation	P_{tot}	$T_j = T_{jmax}$ $T_s = 80\text{ °C}$	151	W
Maximum Junction Temperature	T_{jmax}		175	°C



Vincotech

10-PH12NAB008MR02-LC59F38T
10-PH12NAC008MR02-LC69F38T
 target datasheet

Maximum Ratings

$T_j = 25\text{ °C}$, unless otherwise specified

Parameter	Symbol	Condition	Value	Unit
Neutral Point Switch Prot. Diode				
Peak Repetitive Reverse Voltage	V_{RRM}		1200	V
Continuous (direct) forward current	I_F	$T_j = T_{jmax}$ $T_s = 80\text{ °C}$	15	A
Surge (non-repetitive) forward current	I_{FSM}	50 Hz Single Half Sine Wave $t_p = 10\text{ ms}$ $T_j = 150\text{ °C}$	65	A
Surge current capability	$I_{\Delta t}$		21	A ² s
Total power dissipation	P_{tot}	$T_j = T_{jmax}$ $T_s = 80\text{ °C}$	39	W
Maximum Junction Temperature	T_{jmax}		175	°C

AC Switch

Drain-source voltage	V_{DSS}		1200	V
Drain current	I_D	$T_j = T_{jmax}$ $T_s = 80\text{ °C}$	141	A
Peak drain current	I_{DM}	t_p limited by T_{jmax}	685	A
Total power dissipation	P_{tot}	$T_j = T_{jmax}$ $T_s = 80\text{ °C}$	279	W
Gate-source voltage	V_{GSS}		-4/22	V
Maximum Junction Temperature	T_{jmax}		175	°C

AC Diode

Peak repetitive reverse voltage	V_{RRM}		1200	V
Continuous (direct) forward current	I_F	$T_j = T_{jmax}$ $T_s = 80\text{ °C}$	72	A
Repetitive peak forward current	I_{FRM}		252	A
Total power dissipation	P_{tot}	$T_j = T_{jmax}$ $T_s = 80\text{ °C}$	183	W
Maximum junction temperature	T_{jmax}		175	°C

GS Capacitor

Maximum DC voltage	V_{MAX}		25	V
Operation Temperature	T_{op}		-55...+125	°C



Vincotech

10-PH12NAB008MR02-LC59F38T
10-PH12NAC008MR02-LC69F38T
target datasheet

Maximum Ratings

$T_j = 25\text{ °C}$, unless otherwise specified

Parameter	Symbol	Condition	Value	Unit
-----------	--------	-----------	-------	------

Module Properties

Thermal Properties

Storage temperature	T_{stg}		-40...+125	°C
Operation temperature under switching condition	T_{top}		-40...(T _{max} - 25)	°C

Isolation Properties

Isolation voltage	V_{isol}	DC Test Voltage* $t_p = 2\text{ s}$	6000	V
		AC Voltage $t_p = 1\text{ min}$	2500	V
Creepage distance			>12,7	mm
Clearance			8,21	mm
Comparative Tracking Index	CTI		> 200	

*100 % tested in production



Vincotech

10-PH12NAB008MR02-LC59F38T
10-PH12NAC008MR02-LC69F38T
 target datasheet

Characteristic Values

Parameter	Symbol	Conditions					Value			Unit
		V_{GS} [V]	V_{GE} [V]	V_{DS} [V]	I_D [A]	T_j [°C]	Min	Typ	Max	

DC-Link Switch

Static

Parameter	Symbol	V_{GS} [V]	V_{GE} [V]	V_{DS} [V]	I_D [A]	T_j [°C]	Min	Typ	Max	Unit
Gate-emitter threshold voltage	$V_{GE(th)}$		$V_{GE} = V_{CE}$		0,015	25	5,4	6	6,6	V
Collector-emitter saturation voltage	V_{CEsat}			15	150	25 125 150		1,70 1,97 2,02	2,05	V
Collector-emitter cut-off current	I_{CES}			0	1200	25			160	μA
Gate-emitter leakage current	I_{GES}			20	0	25			500	nA
Internal gate resistance	r_g							3		Ω
Input capacitance	C_{ies}							30000		pF
Output capacitance	C_{oes}			0	10	25		880		
Reverse transfer capacitance	C_{res}							320		
Gate charge	Q_g			15	600	150	25	1000		nC

Thermal

Parameter	Symbol	λ_{paste} [W/mK] (PSX)	Min	Typ	Max	Unit
Thermal resistance junction to sink	$R_{th(j-s)}$	3,4		0,41		K/W

DC-Link Diode

Static

Parameter	Symbol	V_{GS} [V]	V_{GE} [V]	V_{DS} [V]	I_D [A]	T_j [°C]	Min	Typ	Max	Unit
Forward voltage	V_F				100	25 125 150		1,74 1,98 1,98	2,15	V
Reverse leakage current	I_R				1200	25			60	μA

Thermal

Parameter	Symbol	λ_{paste} [W/mK] (PSX)	Min	Typ	Max	Unit
Thermal resistance junction to sink	$R_{th(j-s)}$	3,4		0,79		K/W

DC-Link Switch Inverse Diode

Static

Parameter	Symbol	V_{GS} [V]	V_{GE} [V]	V_{DS} [V]	I_D [A]	T_j [°C]	Min	Typ	Max	Unit
Forward voltage	V_F				100	25 125 150		1,74 1,98 1,98	2,15	V
Reverse leakage current	I_R				1200	25			60	μA

Thermal

Parameter	Symbol	λ_{paste} [W/mK] (PSX)	Min	Typ	Max	Unit
Thermal resistance junction to sink	$R_{th(j-s)}$	3,4		0,79		K/W



Vincotech

10-PH12NAB008MR02-LC59F38T
10-PH12NAC008MR02-LC69F38T
 target datasheet

Characteristic Values

Parameter	Symbol	Conditions					Value			Unit
		V_{GS} [V]	V_{GE} [V]	V_{DS} [V]	I_D [A]	T_j [°C]	Min	Typ	Max	

Neutral Point Switch

Static

Parameter	Symbol	$V_{GE} = V_{CE}$	V_{GS} [V]	V_{CE} [V]	I_C [A]	T_j [°C]	Min	Typ	Max	Unit
Gate-emitter threshold voltage	$V_{GE(th)}$				0,015	25	5,4	6	6,6	V
Collector-emitter saturation voltage	V_{CEsat}		15		150	25 125 150		1,70 1,97 2,02	2,05	V
Collector-emitter cut-off current	I_{CES}		0	1200		25			160	μA
Gate-emitter leakage current	I_{GES}		20	0		25			500	nA
Internal gate resistance	r_g							3		Ω
Input capacitance	C_{ies}							30000		pF
Output capacitance	C_{oes}		0	10		25		880		
Reverse transfer capacitance	C_{res}							320		
Gate charge	Q_g		15	600	150	25		1000		nC

Thermal

Parameter	Symbol	Conditions	Unit
Thermal resistance junction to sink	$R_{th(j-s)}$	$\lambda_{paste} = 3,4 \text{ W/mK}$ (PSX)	K/W

Dynamic

Parameter	Symbol	$R_{goff} = 4 \Omega$ $R_{gon} = 4 \Omega$	V_{GS} [V]	V_{CE} [V]	I_D [A]	T_j [°C]	Min	Typ	Max	Unit
Turn-on delay time	$t_{d(on)}$		±15	600	110	25		397		ns
Rise time	t_r					125		403		
						150		405		
						25		61		
Turn-off delay time	$t_{d(off)}$					125		71		
		150		75						
		25		307						
Fall time	t_f	125		348						
		150		360						
		25		88						
Turn-on energy (per pulse)	E_{on}	$Q_{tFWD} = 10,6 \mu\text{C}$ $Q_{tFWD} = 14,8 \mu\text{C}$ $Q_{tFWD} = 16,5 \mu\text{C}$				25		13,439		mWs
						125		15,742		
						150		16,533		
Turn-off energy (per pulse)	E_{off}					25		7,262		
						125		9,977		
						150		10,645		



Vincotech

10-PH12NAB008MR02-LC59F38T
10-PH12NAC008MR02-LC69F38T
 target datasheet

Characteristic Values

Parameter	Symbol	Conditions					Value			Unit
		V_{GE} [V]	V_{CE} [V]	I_C [A]	T_j [°C]	Min	Typ	Max		

Neutral Point Diode

Static

Parameter	Symbol	V_{GE} [V]	V_{CE} [V]	I_C [A]	T_j [°C]	Min	Typ	Max	Unit
Forward voltage	V_F			150	25 125 150		1,80 1,90 1,90	2,15	V
Reverse leakage current	I_r		1200		25			90	μA

Thermal

Parameter	Symbol	Conditions	Value	Unit
Thermal resistance junction to sink	$R_{th(j-s)}$	$\lambda_{paste} = 3,4$ W/mK (PSX)	0,63	K/W

Dynamic

Parameter	Symbol	V_{GE} [V]	V_{CE} [V]	I_C [A]	T_j [°C]	Min	Typ	Max	Unit
Peak recovery current	I_{RRM}				25 125 150		59 61 61		A
Reverse recovery time	t_{rr}				25 125 150		347 471 513		ns
Recovered charge	Q_r	$di/dt = 1592$ A/μs $di/dt = 1303$ A/μs $di/dt = 1123$ A/μs	±15	600	110	25 125 150	10,571 14,821 16,511		μC
Reverse recovered energy	E_{rec}				25 125 150		3,292 5,159 5,896		mWs
Peak rate of fall of recovery current	$(di_{rf}/dt)_{max}$				25 125 150		210 223 208		A/μs

Neutral Point Switch Prot. Diode

Static

Parameter	Symbol	V_{GE} [V]	V_{CE} [V]	I_C [A]	T_j [°C]	Min	Typ	Max	Unit
Forward voltage	V_F			30	25 125		2,37 2,47	2,71	V
Reverse leakage current	I_R		1200		25 150			120 3600	μA

Thermal

Parameter	Symbol	Conditions	Value	Unit
Thermal resistance junction to sink	$R_{th(j-s)}$	$\lambda_{paste} = 3,4$ W/mK (PSX)	2,46	K/W



Vincotech

10-PH12NAB008MR02-LC59F38T
10-PH12NAC008MR02-LC69F38T
 target datasheet

Characteristic Values

Parameter	Symbol	Conditions					Value			Unit
		V_{GS} [V]	V_{CE} [V] V_{DS} [V]	I_C [A] I_D [A] I_F [A]	T_j [°C]	Min	Typ	Max		

AC Switch

Static

Drain-source on-state resistance	$r_{DS(on)}$	18		100	25 125 150		8 11 12	10	mΩ
Gate-source threshold voltage	$V_{GS(th)}$		10	0,05	25	2,7		5,6	V
Gate to Source Leakage Current	I_{GSS}	-4/22	0		25			±500	nA
Zero Gate Voltage Drain Current	I_{DSS}	0	1200		25			50	μA
Internal gate resistance	r_g						1,4		Ω
Gate charge	Q_g						535		nC
Gate to source charge	Q_{GS}	18	600	100	25		110		
Gate to drain charge	Q_{GD}						205		
Short-circuit input capacitance	C_{iss}						6685		pF
Short-circuit output capacitance	C_{oss}	$f = 1$ MHz	0	800	25		380		
Reverse transfer capacitance	C_{rss}						135		

Reverse Diode Static

Diode forward voltage	V_{SD}	0		100	25		3,2		V
-----------------------	----------	---	--	-----	----	--	-----	--	---

Thermal

Thermal resistance junction to sink	$R_{th(j-s)}$	$\lambda_{paste} = 3,4$ W/mK (PSX)					0,34		K/W
-------------------------------------	---------------	---------------------------------------	--	--	--	--	------	--	-----

Dynamic

Turn-on delay time	$t_{d(on)}$				25 125 150		30 29 27		ns
Rise time	t_r	$R_{goff} = 1$ Ω $R_{gon} = 1$ Ω			25 125 150		14 15 15		
Turn-off delay time	$t_{d(off)}$		0/16	600	99		83 101 101		
Fall time	t_f				25 125 150		9 13 13		
Turn-on energy (per pulse)	E_{on}	$Q_{tFWD} = 0,4$ μC $Q_{tFWD} = 0,8$ μC $Q_{tFWD} = 1,4$ μC			25 125 150		1,256 1,436 1,410		
Turn-off energy (per pulse)	E_{off}				25 125 150		1,016 1,421 1,482		mWs



Characteristic Values

Parameter	Symbol	Conditions					Value			Unit
		V_{GE} [V]	V_{CE} [V]	I_C [A]	T_j [°C]	Min	Typ	Max		

AC Diode

Static

Forward voltage	V_F			60	25 125		1,63 2,04	1,7	V
Reverse leakage current	I_R		1200		25			1200	μ A

Thermal

Thermal resistance junction to sink	$R_{th(j-s)}$	$\lambda_{paste} = 3,4$ W/mK (PSX)					0,52		K/W
-------------------------------------	---------------	------------------------------------	--	--	--	--	------	--	-----

Dynamic

Peak recovery current	I_{RRM}				25 125 150		59 52 54		A
Reverse recovery time	t_{rr}				25 125 150		14 15 51		ns
Recovered charge	Q_r	$di/dt = 7141$ A/ μ s $di/dt = 10501$ A/ μ s $di/dt = 8639$ A/ μ s	0/16	600	99	25 125 150	0,432 0,794 1,431		μ C
Reverse recovered energy	E_{rec}				25 125 150		0,068 0,221 0,537		mWs
Peak rate of fall of recovery current	$(di_{rr}/dt)_{max}$				25 125 150		13486 10799 4954		A/ μ s

GS Capacitor

Capacitance	C						10		nF
Tolerance							-10	+10	%
Dissipation factor		$f = 1$ kHz				25		0,1	%

Thermistor

Rated resistance	R					25	22		k Ω
Deviation of R_{100}	$\Delta_{R/R}$	$R_{100} = 1484$ Ω				100	-5	5	%
Power dissipation	P					25	5		mW
Power dissipation constant						25	1,5		mW/K
B-value	$B_{(25/50)}$	Tol. ± 1 %				25	3962		K
B-value	$B_{(25/100)}$	Tol. ± 1 %				25	4000		K
Vincotech NTC Reference								I	



DC-Link Switch Characteristics

figure 1. IGBT

Typical output characteristics

$$I_C = f(V_{GE})$$

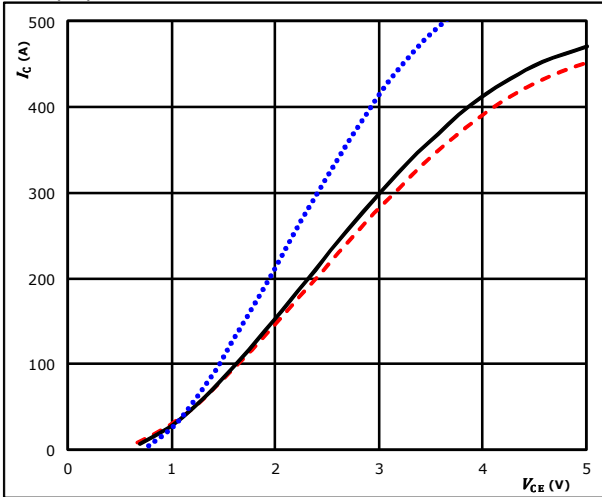

$t_p = 250 \mu s$
 $V_{GE} = 15 V$
 $T_j: 25 \text{ }^\circ C$ (dotted blue)
 $125 \text{ }^\circ C$ (solid black)
 $150 \text{ }^\circ C$ (dashed red)

figure 2. IGBT

Typical output characteristics

$$I_C = f(V_{GE})$$

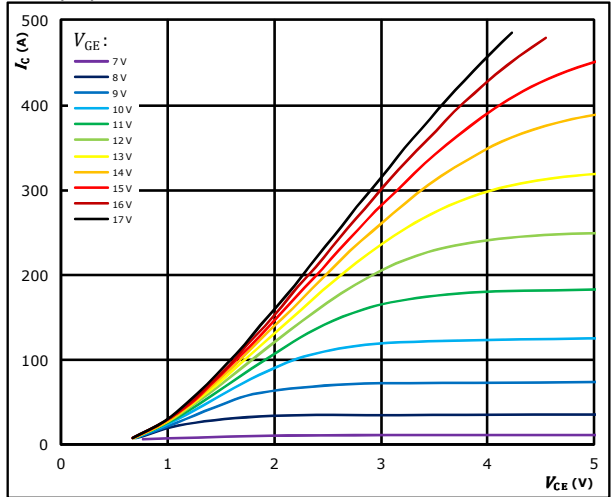

$t_p = 250 \mu s$
 $T_j = 150 \text{ }^\circ C$
 V_{GE} from 7 V to 17 V in steps of 1 V

figure 3. IGBT

Typical transfer characteristics

$$I_C = f(V_{GE})$$

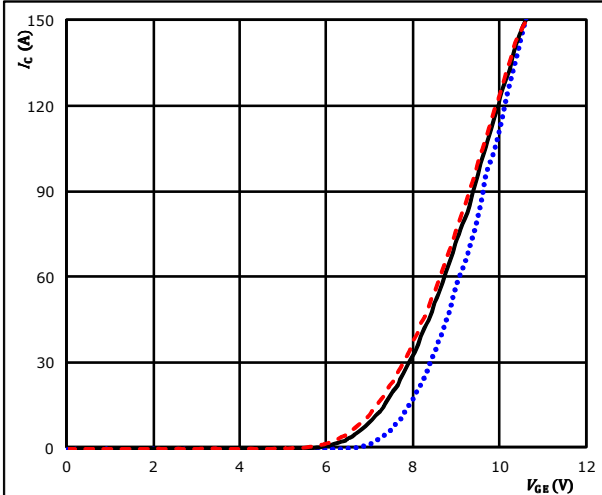

$t_p = 100 \mu s$
 $V_{GE} = 10 V$
 $T_j: 25 \text{ }^\circ C$ (dotted blue)
 $125 \text{ }^\circ C$ (solid black)
 $150 \text{ }^\circ C$ (dashed red)

figure 4. IGBT

Transient thermal impedance as function of pulse duration

$$Z_{th(j-s)} = f(t_p)$$

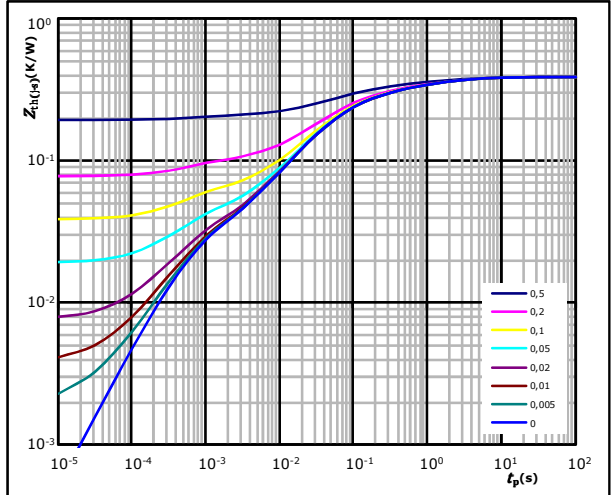

$D = t_p / T$
 $R_{th(j-s)} = 0,41 \text{ K/W}$
 IGBT thermal model values

R (K/W)	τ (s)
4,47E-02	2,80E+00
9,73E-02	5,59E-01
2,47E-01	1,59E-01
3,88E-02	2,12E-02
1,13E-02	5,12E-03
1,42E-02	6,59E-04



DC-Link Switch Characteristics

figure 5. IGBT

Gate voltage vs gate charge

$V_{GE} = f(Q_G)$

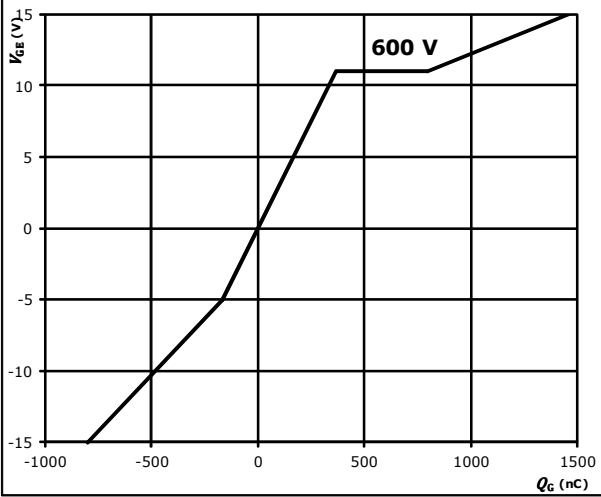

$I_C = 150$ A
 $V_{GE} = \pm 15$ V
 $V_{CC} = 600$ V

figure 6. IGBT

Safe operating area

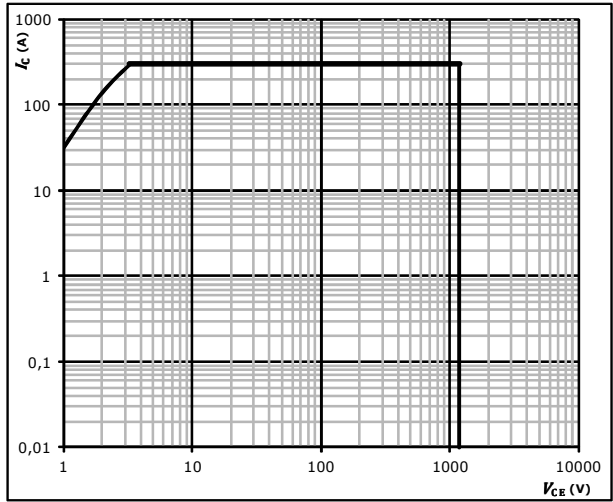

$D =$ single pulse
 $T_s = 80$ °C
 $V_{GE} = \pm 15$ V
 $T_j = T_{jmax}$



DC-Link Diode Characteristics

figure 1. FWD

Typical forward characteristics

$$I_F = f(V_F)$$

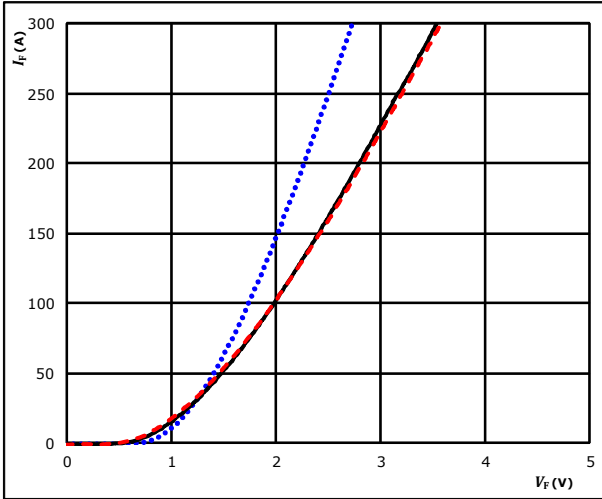

$t_p = 250 \mu\text{s}$
 T_j : 25 °C (blue dotted line)
 125 °C (black solid line)
 150 °C (red dashed line)

figure 2. FWD

Transient thermal impedance as a function of pulse width

$$Z_{th(j-s)} = f(t_p)$$

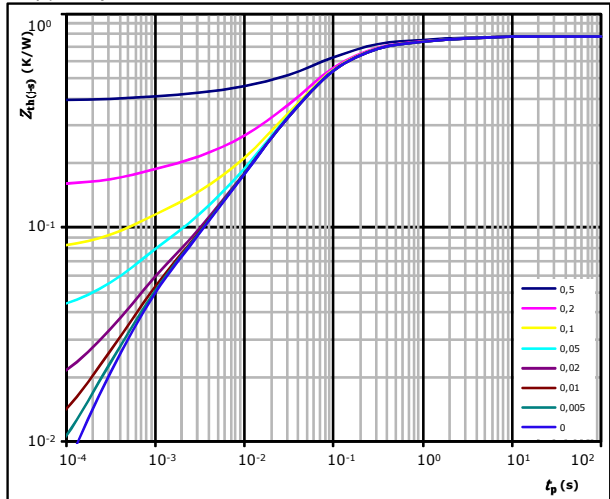

$D = t_p / T$
 $R_{th(j-s)} = 0,79 \text{ K/W}$
 FWD thermal model values

R (K/W)	τ (s)
4,05E-02	3,25E+00
9,02E-02	5,38E-01
3,71E-01	8,95E-02
1,97E-01	3,04E-02
5,23E-02	4,59E-03
3,58E-02	6,26E-04



DC-Link Switch Inverse Diode Characteristics

figure 1. FWD

Typical forward characteristics

$$I_F = f(V_F)$$

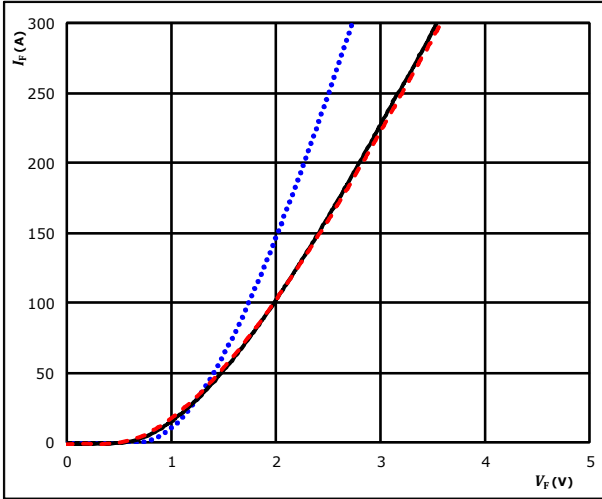

$t_p = 250 \mu s$

T_j : 25 °C
 125 °C ———
 150 °C - - - -

figure 2. FWD

Transient thermal impedance as a function of pulse width

$$Z_{th(j-s)} = f(t_p)$$

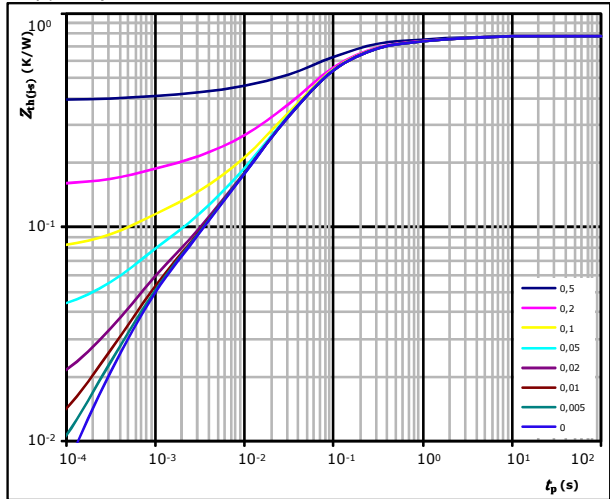

$D = t_p / T$

$R_{th(j-s)} = 0,79 \text{ K/W}$

FWD thermal model values

R (K/W)	τ (s)
4,05E-02	3,25E+00
9,02E-02	5,38E-01
3,71E-01	8,95E-02
1,97E-01	3,04E-02
5,23E-02	4,59E-03
3,58E-02	6,26E-04



Vincotech

10-PH12NAB008MR02-LC59F38T
10-PH12NAC008MR02-LC69F38T
 target datasheet

Neutral Point Switch Characteristics

figure 1. IGBT

Typical output characteristics

$$I_C = f(V_{CE})$$

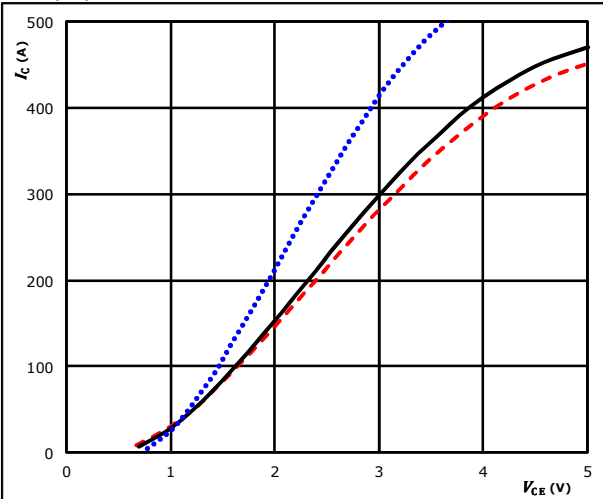

$t_p = 250 \mu\text{s}$
 $V_{GE} = 15 \text{ V}$
 $T_j: 25 \text{ }^\circ\text{C}$ (blue dotted line)
 $125 \text{ }^\circ\text{C}$ (black solid line)
 $150 \text{ }^\circ\text{C}$ (red dashed line)

figure 2. IGBT

Typical output characteristics

$$I_C = f(V_{CE})$$

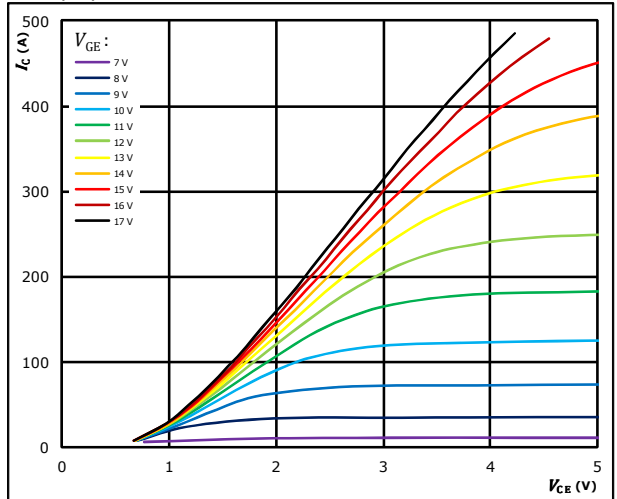

$t_p = 250 \mu\text{s}$
 $T_j = 150 \text{ }^\circ\text{C}$
 V_{GE} from 7 V to 17 V in steps of 1 V

figure 3. IGBT

Typical transfer characteristics

$$I_C = f(V_{GE})$$

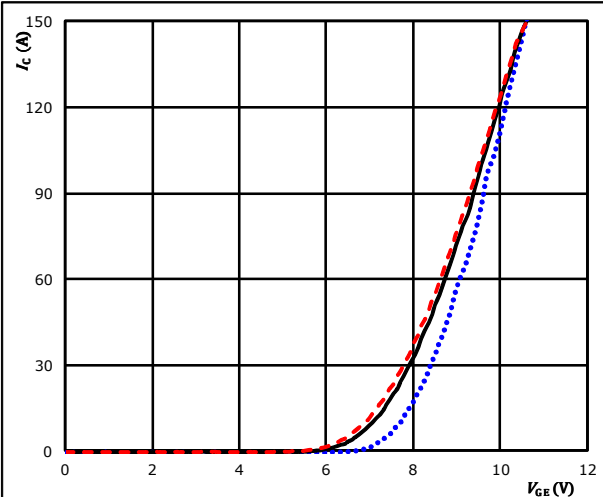

$t_p = 100 \mu\text{s}$
 $V_{CE} = 10 \text{ V}$
 $T_j: 25 \text{ }^\circ\text{C}$ (blue dotted line)
 $125 \text{ }^\circ\text{C}$ (black solid line)
 $150 \text{ }^\circ\text{C}$ (red dashed line)

figure 4. IGBT

Transient thermal impedance as function of pulse duration

$$Z_{th(\theta-s)} = f(t_p)$$

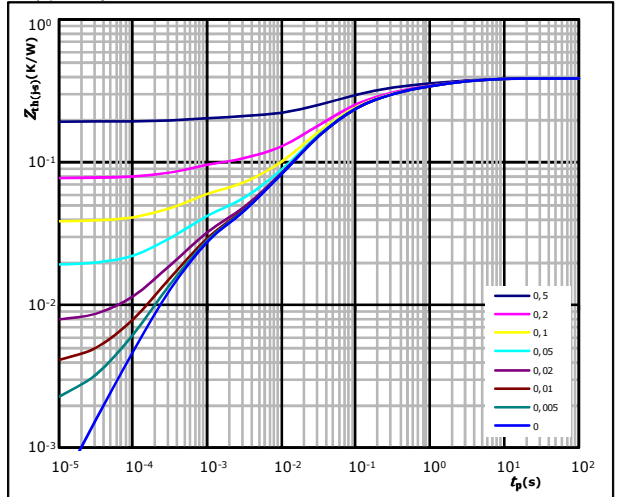

$D = t_p / T$
 $R_{th(\theta-s)} = 0,41 \text{ K/W}$
 IGBT thermal model values

R (K/W)	τ (s)
4,47E-02	2,80E+00
9,73E-02	5,59E-01
2,47E-01	1,59E-01
3,88E-02	2,12E-02
1,13E-02	5,12E-03
1,42E-02	6,59E-04



Neutral Point Switch Characteristics

figure 5. IGBT

Gate voltage vs gate charge

$V_{GE} = f(Q_G)$

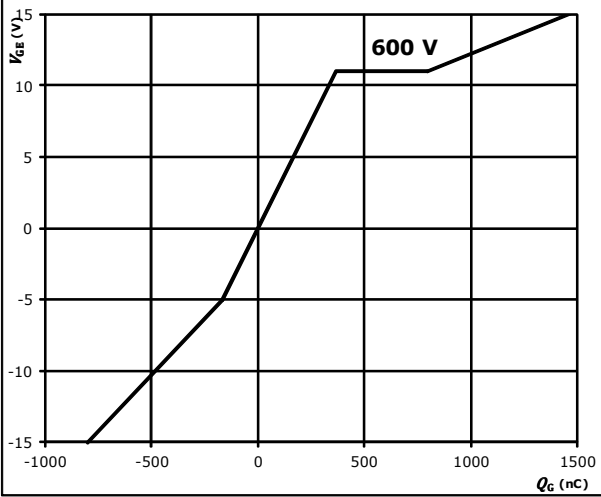

$I_C = 150$ A
 $V_{GE} = \pm 15$ V
 $V_{CC} = 600$ V

figure 6. IGBT

Safe operating area

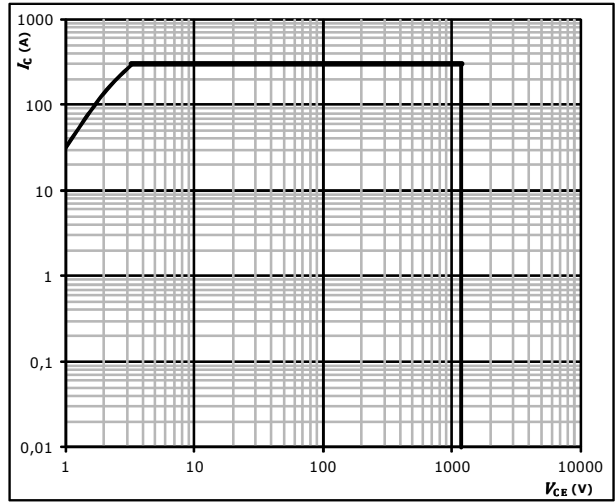

$D =$ single pulse
 $T_s = 80$ °C
 $V_{GE} = \pm 15$ V
 $T_j = T_{jmax}$



Neutral Point Diode Characteristics

figure 1. FWD

Typical forward characteristics

$$I_F = f(V_F)$$

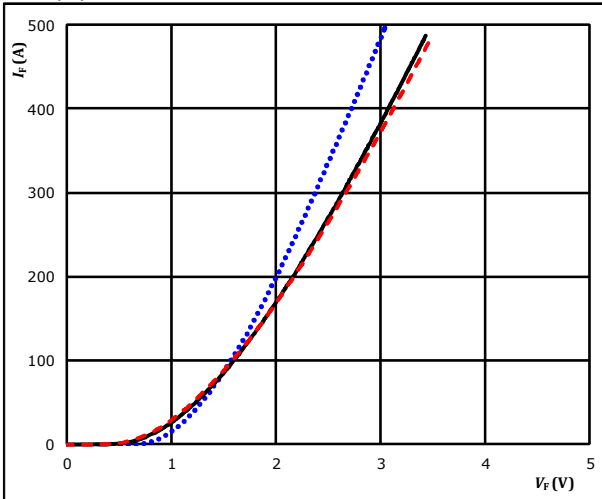

$t_p = 250 \mu s$
 T_j : 25 °C (blue dotted line)
 125 °C (black solid line)
 150 °C (red dashed line)

figure 2. FWD

Transient thermal impedance as a function of pulse width

$$Z_{th(j-s)} = f(t_p)$$

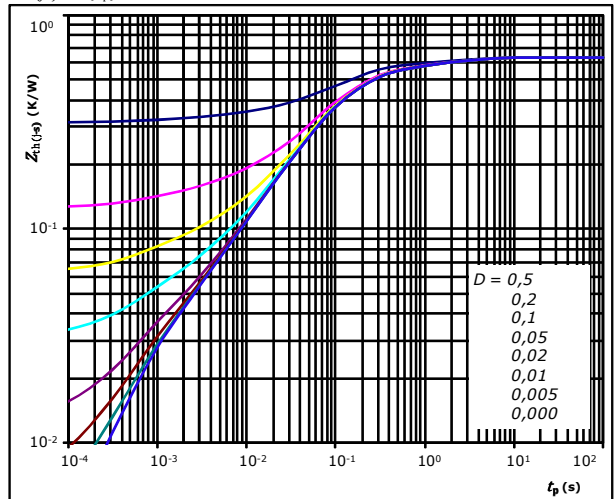

$D = t_p / T$
 $R_{th(j-s)} = 0,63 \text{ K/W}$

FWD thermal model values

R (K/W)	τ (s)
5,76E-02	2,80E+00
9,23E-02	5,30E-01
3,12E-01	1,04E-01
1,04E-01	3,96E-02
4,08E-02	6,94E-03
2,31E-02	8,04E-04



Neutral Point Switch Prot. Diode Characteristics

figure 1. FWD
Typical forward characteristics

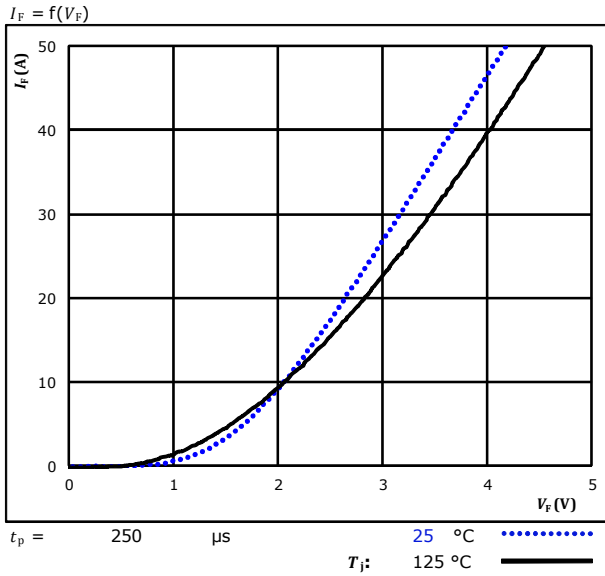
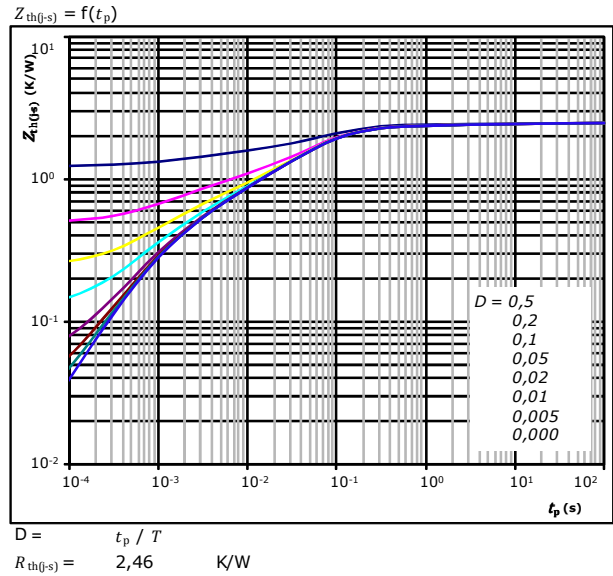

figure 2. FWD
Transient thermal impedance as a function of pulse width



FWD thermal model values

R (K/W)	τ (s)
8,08E-02	9,59E+00
1,72E-01	5,73E-01
1,10E+00	7,81E-02
5,04E-01	2,68E-02
3,53E-01	4,22E-03
2,53E-01	8,77E-04



AC Switch Characteristics

figure 1. MOSFET

Typical output characteristics

$I_D = f(V_{DS})$

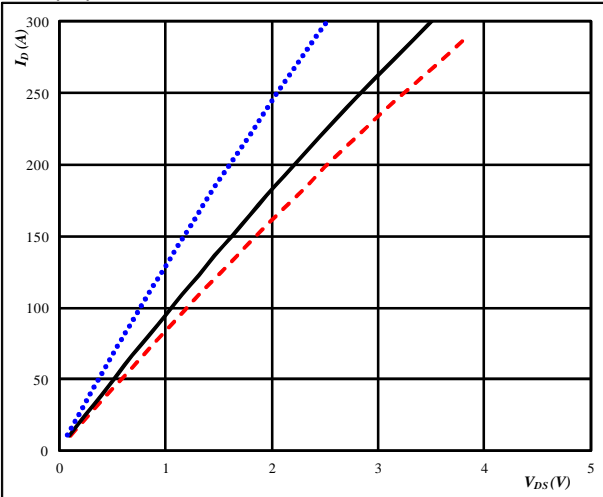

$t_p = 250 \mu s$
 $V_{GS} = 18 V$
 $T_j: 25 \text{ }^\circ C$ (blue dotted line)
 $125 \text{ }^\circ C$ (black solid line)
 $150 \text{ }^\circ C$ (red dashed line)

figure 2. MOSFET

Typical output characteristics

$I_D = f(V_{DS})$

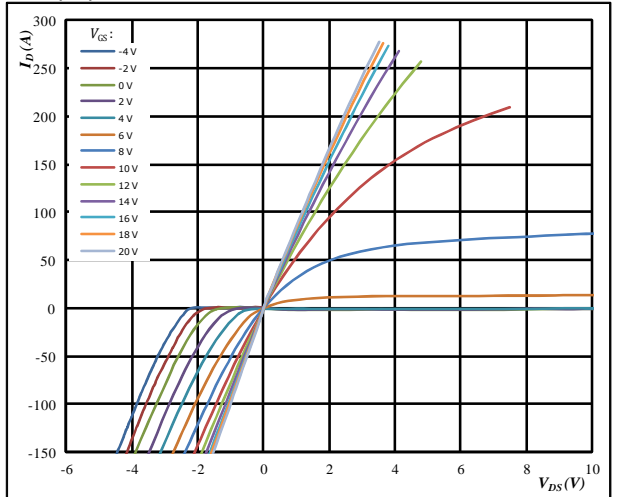

$t_p = 250 \mu s$
 $T_j = 150 \text{ }^\circ C$
 V_{GS} from -4 V to 20 V in steps of 2 V

figure 3. MOSFET

Typical transfer characteristics

$I_D = f(V_{GS})$

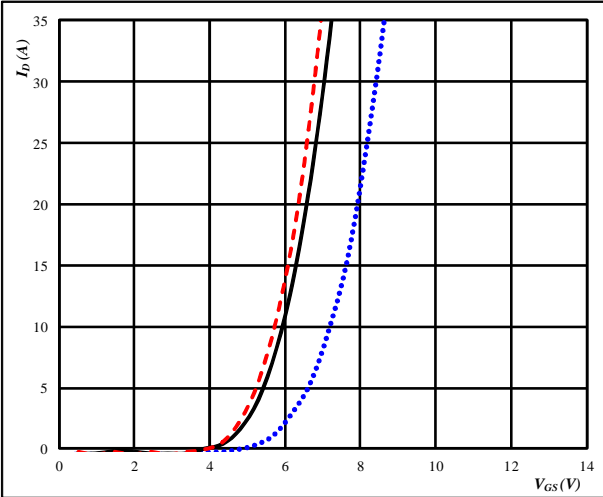

$t_p = 100 \mu s$
 $V_{DS} = 10 V$
 $T_j: 25 \text{ }^\circ C$ (blue dotted line)
 $125 \text{ }^\circ C$ (black solid line)
 $150 \text{ }^\circ C$ (red dashed line)

figure 4. MOSFET

Transient thermal impedance as a function of pulse width

$Z_{th(j-s)} = f(t_p)$

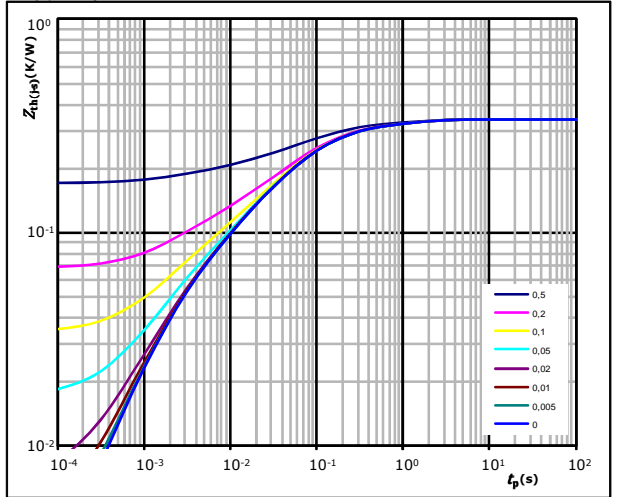

$D = t_p / T$
 $R_{th(j-s)} = 0,34 \text{ K/W}$
 MOSFET thermal model values

R (K/W)	τ (s)
3,91E-02	1,04E+00
1,00E-01	1,44E-01
1,17E-01	4,34E-02
5,18E-02	8,88E-03
3,26E-02	1,76E-03



AC Diode Characteristics

figure 1. FWD

Typical forward characteristics

$$I_F = f(V_F)$$

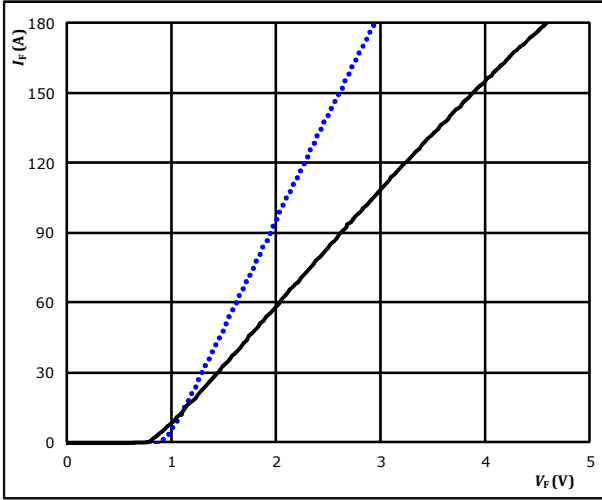

$t_p = 250 \mu s$ $T_j: 25 \text{ }^\circ\text{C}$ (dotted blue line)
 $125 \text{ }^\circ\text{C}$ (solid black line)

figure 2. FWD

Transient thermal impedance as a function of pulse width

$$Z_{th(j-s)} = f(t_p)$$

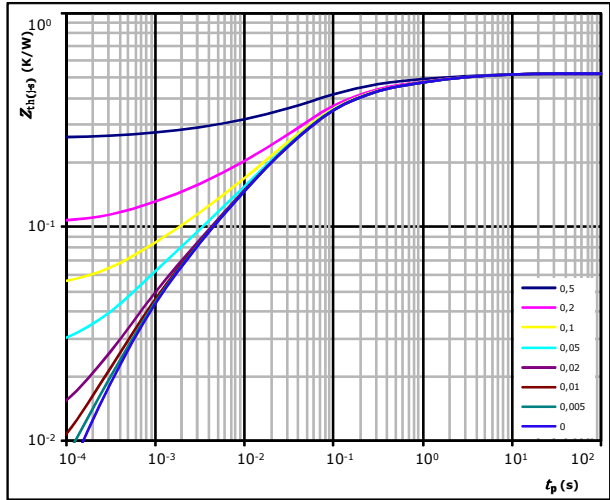

$D = t_p / T$
 $R_{th(j-s)} = 0,52 \text{ K/W}$

FWD thermal model values

$R \text{ (K/W)}$	$\tau \text{ (s)}$
2,95E-02	5,33E+00
6,00E-02	9,85E-01
1,02E-01	1,79E-01
1,92E-01	5,14E-02
7,17E-02	1,10E-02
3,93E-02	2,74E-03
2,53E-02	5,68E-04

Thermistor Characteristics

figure 1. Thermistor

Typical NTC characteristic as a function of temperature

$$R = f(T)$$

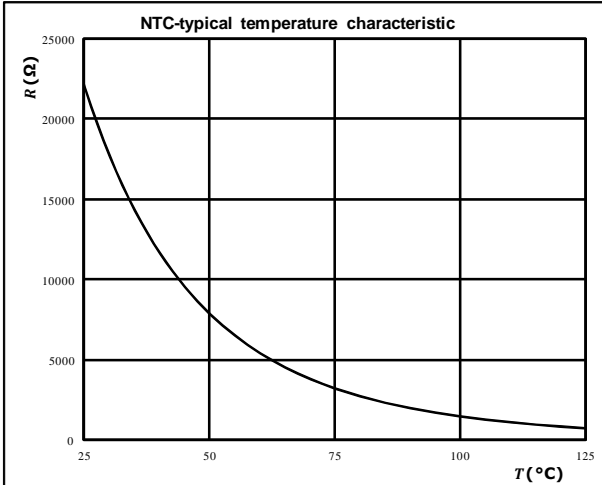



Vincotech

10-PH12NAB008MR02-LC59F38T
10-PH12NAC008MR02-LC69F38T
 target datasheet

Neutral Point Switching Characteristics

figure 1. IGBT

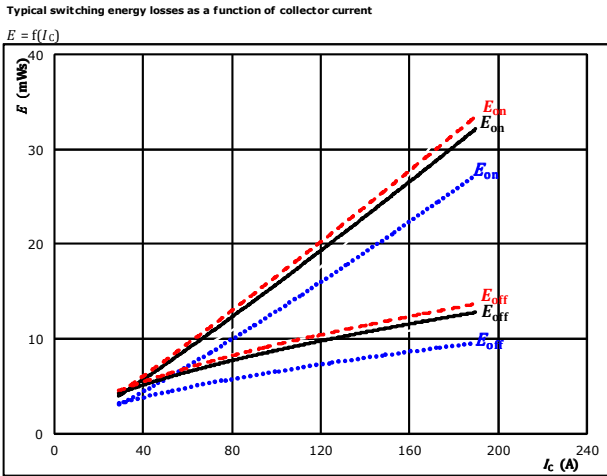

With an inductive load at

$V_{CE} = 600$ V	$T_j: 25$ °C
$V_{GE} = \pm 15$ V	125 °C	————
$R_{gon} = 4$ Ω	150 °C	-----
$R_{goff} = 4$ Ω		

figure 2. IGBT

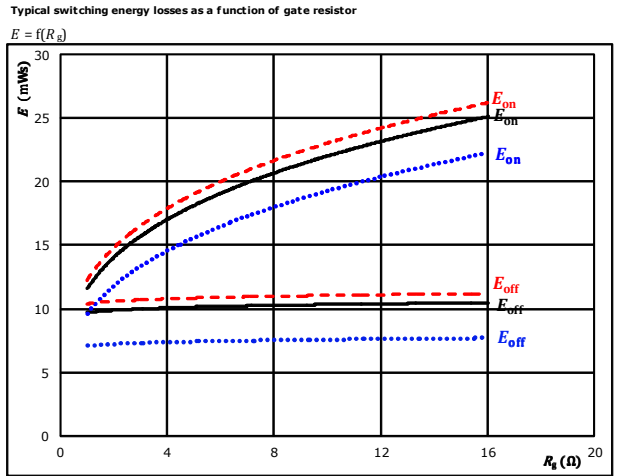

With an inductive load at

$V_{CE} = 600$ V	$T_j: 25$ °C
$V_{GE} = \pm 15$ V	125 °C	————
$I_c = 110$ A	150 °C	-----

figure 3. FWD

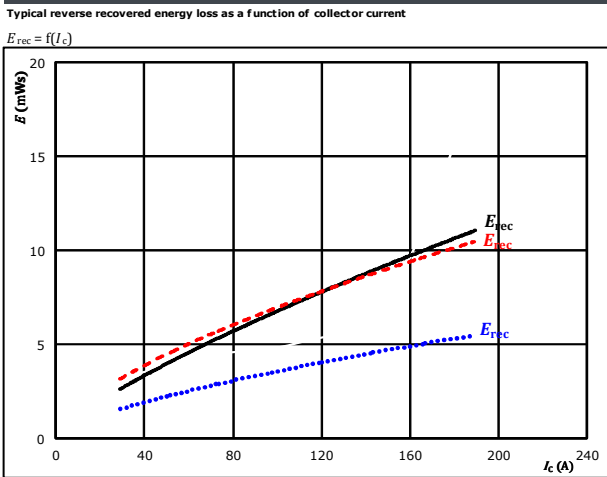

With an inductive load at

$V_{CE} = 600$ V	$T_j: 25$ °C
$V_{GE} = \pm 15$ V	125 °C	————
$R_{gon} = 4$ Ω	150 °C	-----

figure 4. FWD

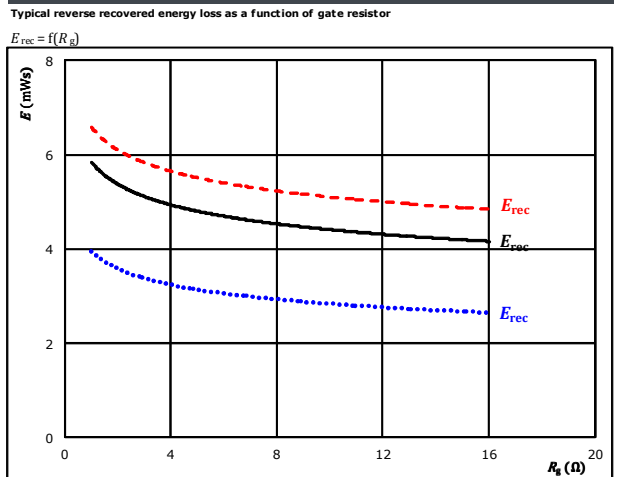

With an inductive load at

$V_{CE} = 600$ V	$T_j: 25$ °C
$V_{GE} = \pm 15$ V	125 °C	————
$I_c = 110$ A	150 °C	-----



Neutral Point Switching Characteristics

figure 5. IGBT

Typical switching times as a function of collector current

$$t = f(I_C)$$

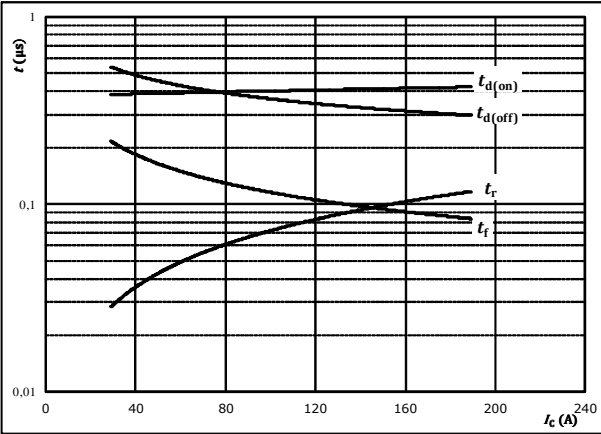

With an inductive load at

$T_j =$	150	°C
$V_{CE} =$	600	V
$V_{GE} =$	±15	V
$R_{gon} =$	4	Ω
$R_{goff} =$	4	Ω

figure 6. IGBT

Typical switching times as a function of gate resistor

$$t = f(R_g)$$

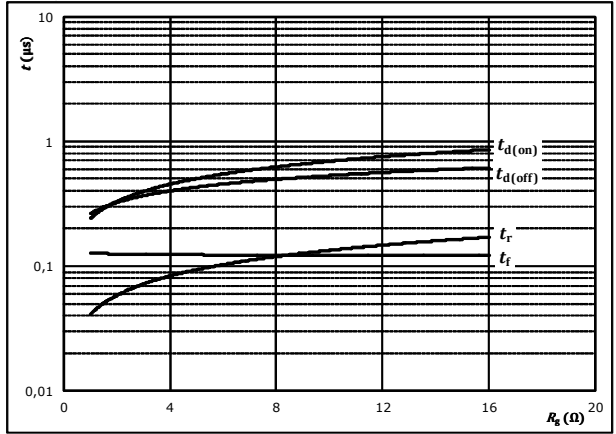

With an inductive load at

$T_j =$	150	°C
$V_{CE} =$	600	V
$V_{GE} =$	±15	V
$I_C =$	110	A

figure 7. FWD

Typical reverse recovery time as a function of collector current

$$t_{rr} = f(I_C)$$

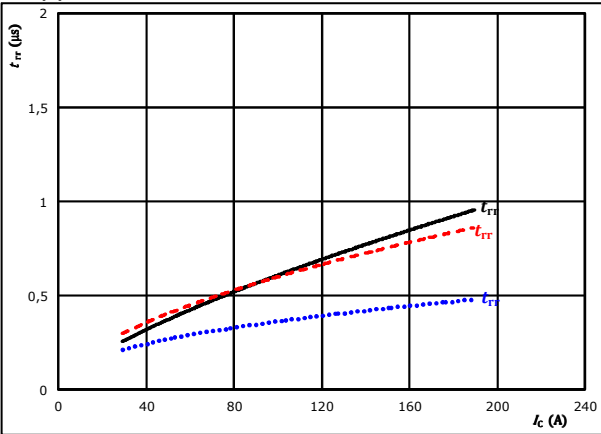

At	$V_{CE} =$	600	V	$T_j:$	25 °C
	$V_{GE} =$	±15	V		125 °C	————
	$R_{gon} =$	4	Ω		150 °C	- - - -

figure 8. FWD

Typical reverse recovery time as a function of IGBT turn on gate resistor

$$t_{rr} = f(R_{gon})$$

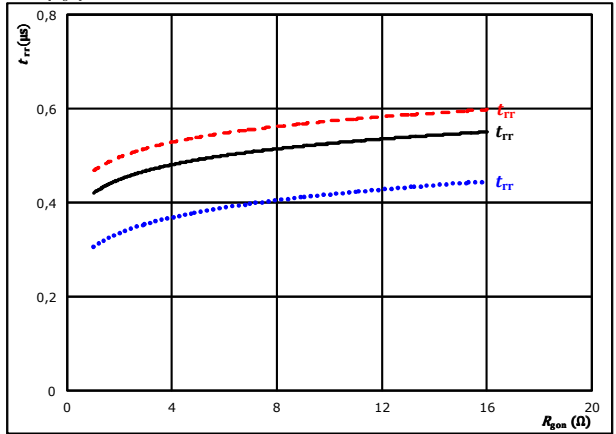

At	$V_{CE} =$	600	V	$T_j:$	25 °C
	$V_{GE} =$	±15	V		125 °C	————
	$I_C =$	110	A		150 °C	- - - -



Vincotech

10-PH12NAB008MR02-LC59F38T
10-PH12NAC008MR02-LC69F38T
 target datasheet

Neutral Point Switching Characteristics

figure 9. FWD

Typical recovered charge as a function of collector current

$$Q_r = f(I_c)$$

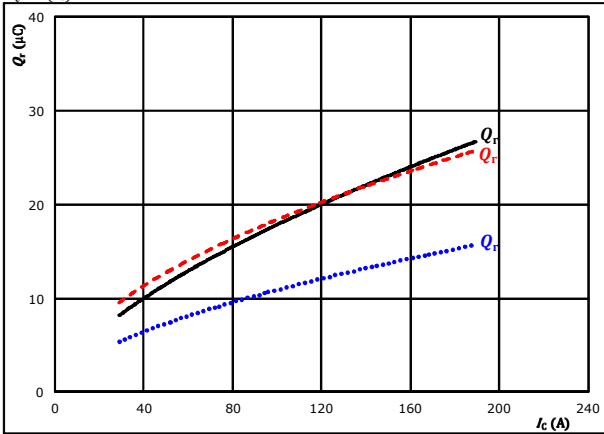

At $V_{CE} = 600$ V $T_j = 25$ °C
 $V_{GE} = \pm 15$ V $T_j = 125$ °C ———
 $R_{gpn} = 4$ Ω $T_j = 150$ °C - - - - -

figure 10. FWD

Typical recovered charge as a function of IGBT turn on gate resistor

$$Q_r = f(R_{gpn})$$

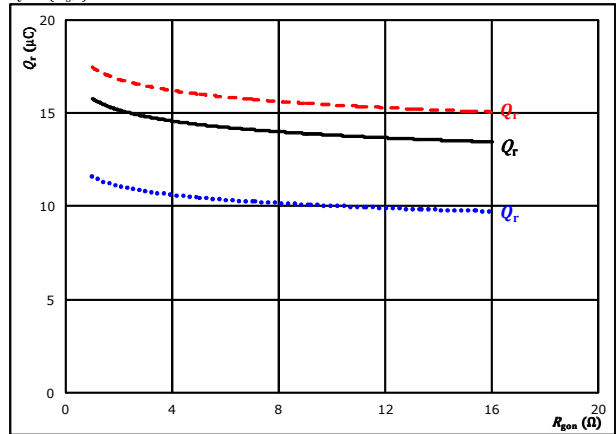

At $V_{CE} = 600$ V $T_j = 25$ °C
 $V_{GE} = \pm 15$ V $T_j = 125$ °C ———
 $I_c = 110$ A $T_j = 150$ °C - - - - -

figure 11. FWD

Typical peak reverse recovery current as a function of collector current

$$I_{RM} = f(I_c)$$

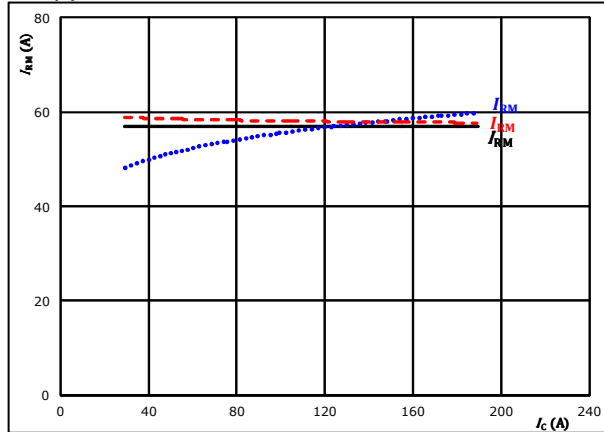

At $V_{CE} = 600$ V $T_j = 25$ °C
 $V_{GE} = \pm 15$ V $T_j = 125$ °C ———
 $R_{gpn} = 4$ Ω $T_j = 150$ °C - - - - -

figure 12. FWD

Typical peak reverse recovery current as a function of IGBT turn on gate resistor

$$I_{RM} = f(R_{gpn})$$

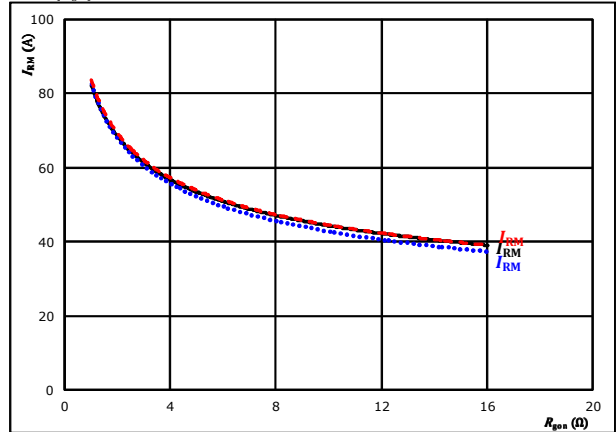

At $V_{CE} = 600$ V $T_j = 25$ °C
 $V_{GE} = \pm 15$ V $T_j = 125$ °C ———
 $I_c = 110$ A $T_j = 150$ °C - - - - -



Neutral Point Switching Characteristics

figure 13. FWD

Typical rate of fall of forward and reverse recovery current as a function of collector current
 $di_F/dt, di_{rr}/dt = f(I_C)$

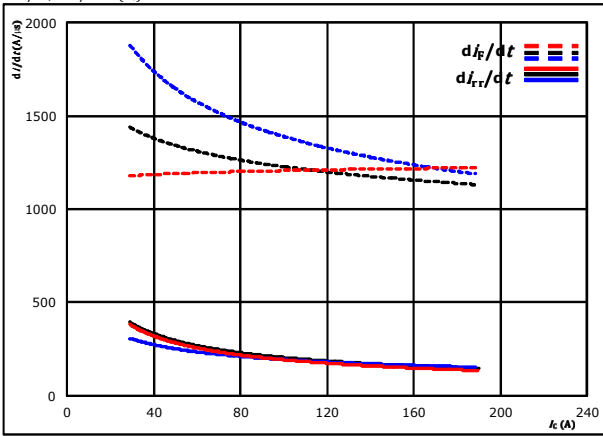

At $V_{CE} = 600$ V $T_j = 25$ °C
 $V_{GE} = \pm 15$ V $T_j = 125$ °C ———
 $R_{gpn} = 4$ Ω $T_j = 150$ °C - - - - -

figure 14. FWD

Typical rate of fall of forward and reverse recovery current as a function of IGBT turn on gate resistor
 $di_F/dt, di_{rr}/dt = f(R_{gpn})$

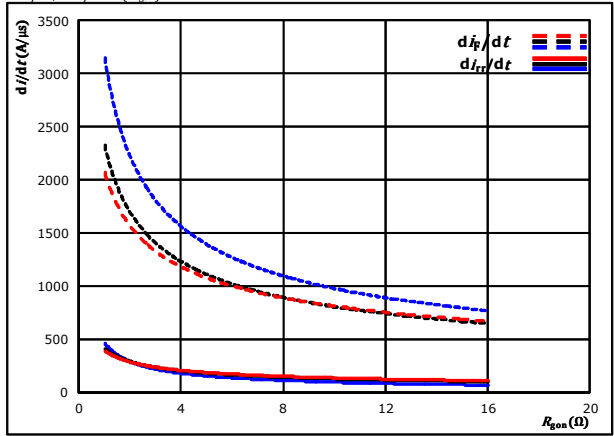

At $V_{CE} = 600$ V $T_j = 25$ °C
 $V_{GE} = \pm 15$ V $T_j = 125$ °C ———
 $I_C = 110$ A $T_j = 150$ °C - - - - -

figure 15. IGBT

Reverse bias safe operating area
 $I_C = f(V_{CE})$

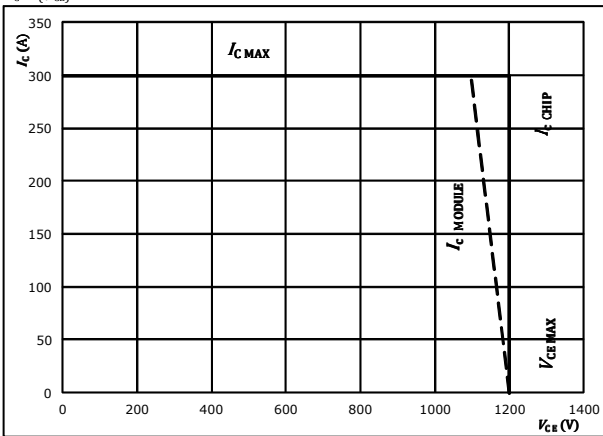

At $T_j = 175$ °C
 $R_{gpn} = 4$ Ω
 $R_{goff} = 4$ Ω



Vincotech

10-PH12NAB008MR02-LC59F38T
 10-PH12NAC008MR02-LC69F38T
 target datasheet

Neutral Point Switching Definitions

General conditions

T_j	=	125 °C
R_{gon}	=	4 Ω
R_{goff}	=	4 Ω

figure 1. IGBT

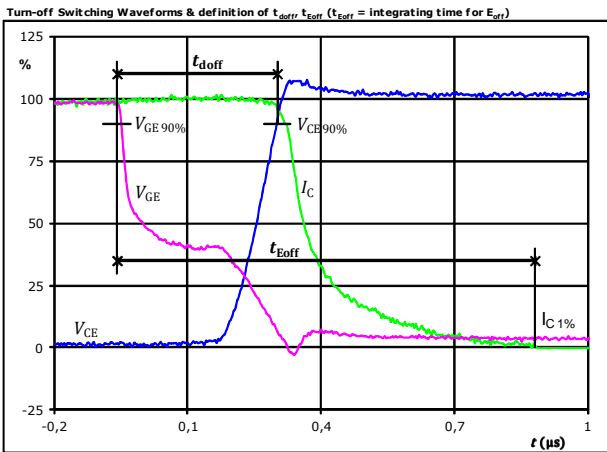

$V_{GE}(0\%) =$	-15	V
$V_{GE}(100\%) =$	15	V
$V_C(100\%) =$	600	V
$I_C(100\%) =$	110	A
$t_{doff} =$	0,348	μs
$t_{Eoff} =$	0,940	μs

figure 2. IGBT

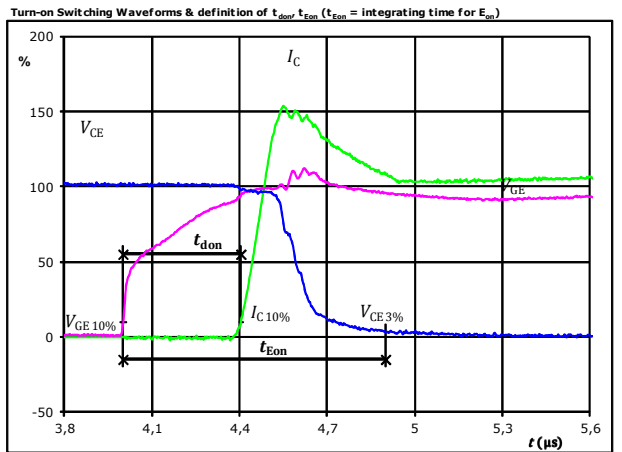

$V_{GE}(0\%) =$	-15	V
$V_{GE}(100\%) =$	15	V
$V_C(100\%) =$	600	V
$I_C(100\%) =$	110	A
$t_{don} =$	0,403	μs
$t_{Eon} =$	0,899	μs

figure 3. IGBT

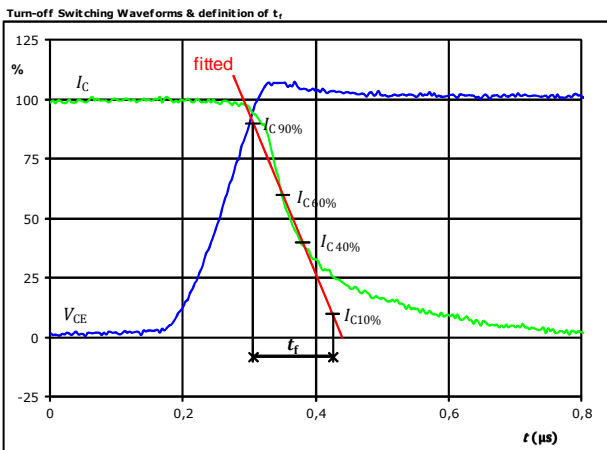

$V_C(100\%) =$	600	V
$I_C(100\%) =$	110	A
$t_f =$	0,119	μs

figure 4. IGBT

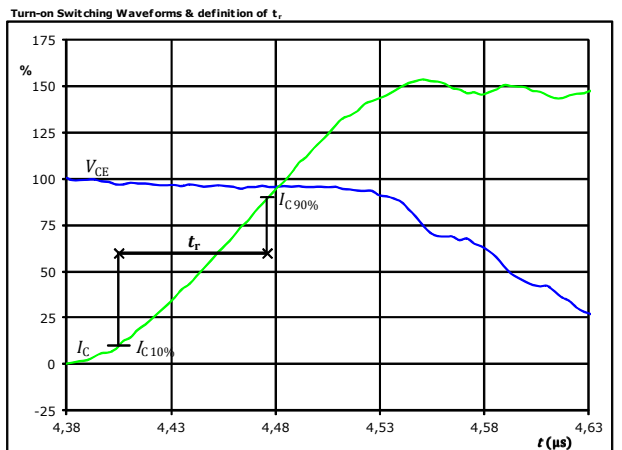

$V_C(100\%) =$	600	V
$I_C(100\%) =$	110	A
$t_r =$	0,071	μs



Vincotech

10-PH12NAB008MR02-LC59F38T
10-PH12NAC008MR02-LC69F38T
 target datasheet

Neutral Point Switching Characteristics

figure 5. IGBT

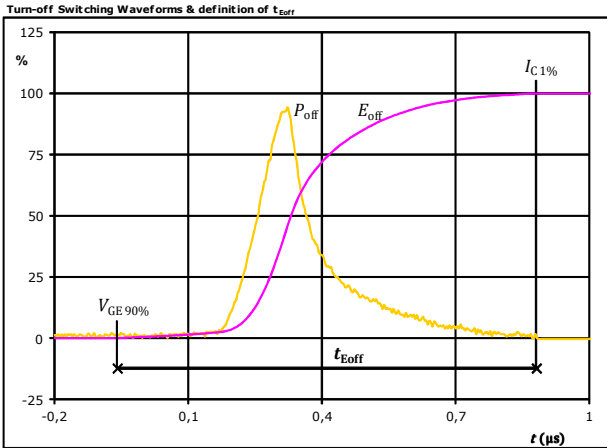

$P_{off}(100\%) = 66,19$ kW
 $E_{off}(100\%) = 9,98$ mJ
 $t_{Eoff} = 0,94$ µs

figure 6. IGBT

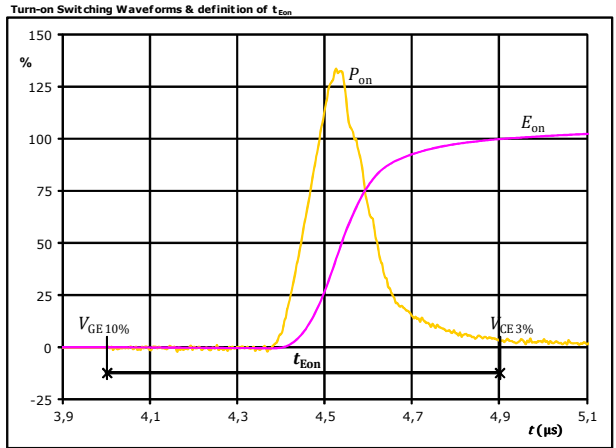

$P_{on}(100\%) = 66,19$ kW
 $E_{on}(100\%) = 15,74$ mJ
 $t_{Eon} = 0,90$ µs

figure 7. FWD

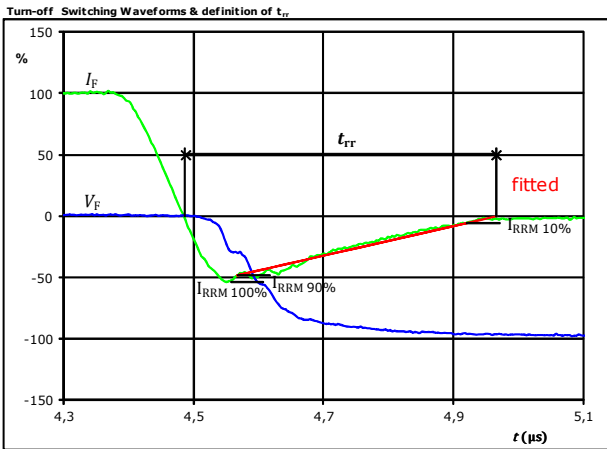

$V_F(100\%) = 600$ V
 $I_F(100\%) = 110$ A
 $I_{RRM}(100\%) = -61$ A
 $t_{rr} = 0,471$ µs



Vincotech

10-PH12NAB008MR02-LC59F38T
10-PH12NAC008MR02-LC69F38T
 target datasheet

Neutral Point Switching Characteristics

figure 8. FWD

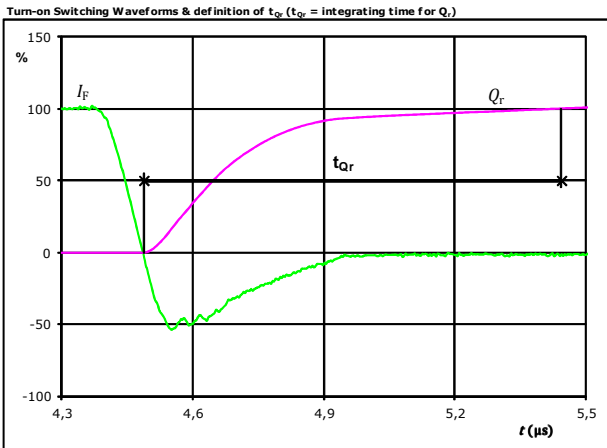

I_F (100%) =	110	A
Q_r (100%) =	14,82	μC
t_{Qr} =	0,96	μs

figure 9. FWD

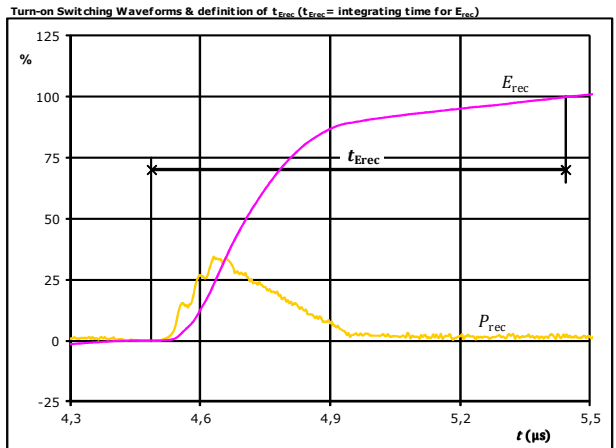

P_{rec} (100%) =	66,19	kW
E_{rec} (100%) =	5,16	mJ
t_{Erec} =	0,96	μs



AC Switching Characteristics

figure 1. IGBT

Typical switching energy losses as a function of collector current

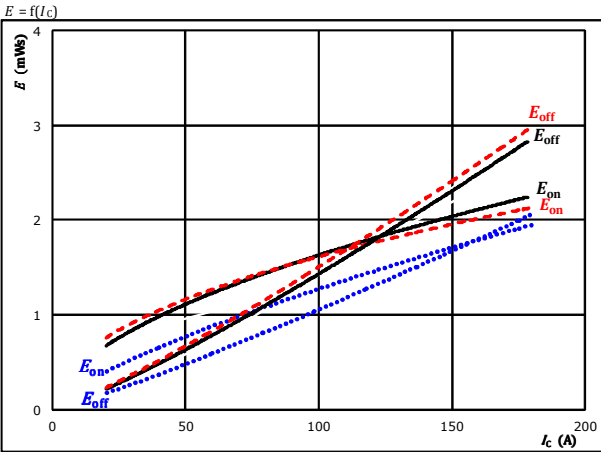

With an inductive load at
 $V_{CE} = 600$ V
 $V_{GE} = 0/16$ V
 $R_{gon} = 1$ Ω
 $R_{goff} = 1$ Ω
 $T_j: 25$ °C (dotted blue)
 125 °C (solid black)
 150 °C (dashed red)

figure 2. IGBT

Typical switching energy losses as a function of gate resistor

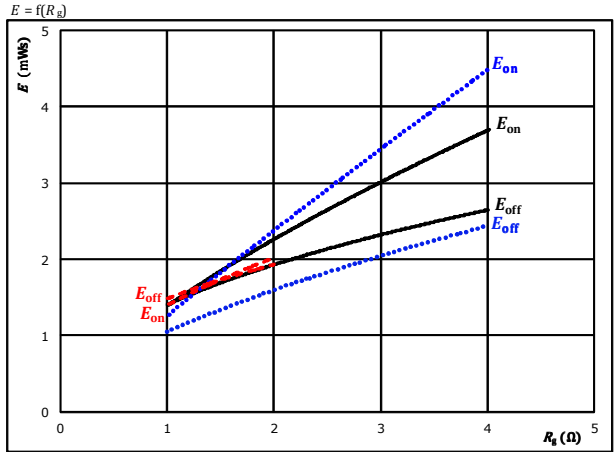

With an inductive load at
 $V_{CE} = 600$ V
 $V_{GE} = 0/16$ V
 $I_C = 99$ A
 $T_j: 25$ °C (dotted blue)
 125 °C (solid black)
 150 °C (dashed red)

figure 3. FWD

Typical reverse recovered energy loss as a function of collector current

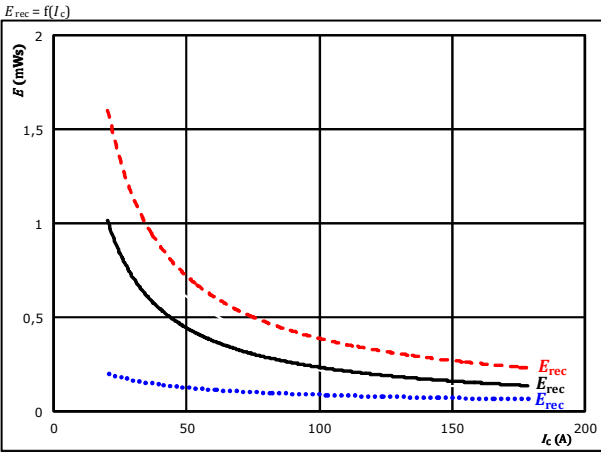

With an inductive load at
 $V_{CE} = 600$ V
 $V_{GE} = 0/16$ V
 $R_{gon} = 1$ Ω
 $T_j: 25$ °C (dotted blue)
 125 °C (solid black)
 150 °C (dashed red)

figure 4. FWD

Typical reverse recovered energy loss as a function of gate resistor

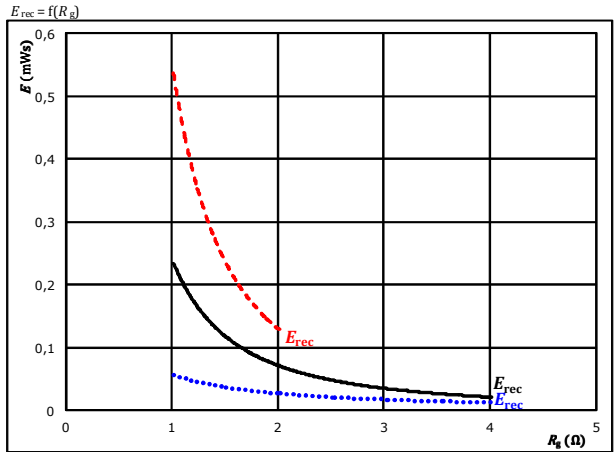

With an inductive load at
 $V_{CE} = 600$ V
 $V_{GE} = 0/16$ V
 $I_C = 99$ A
 $T_j: 25$ °C (dotted blue)
 125 °C (solid black)
 150 °C (dashed red)



Vincotech

10-PH12NAB008MR02-LC59F38T
 10-PH12NAC008MR02-LC69F38T
 target datasheet

AC Switching Characteristics

figure 5. IGBT

Typical switching times as a function of collector current

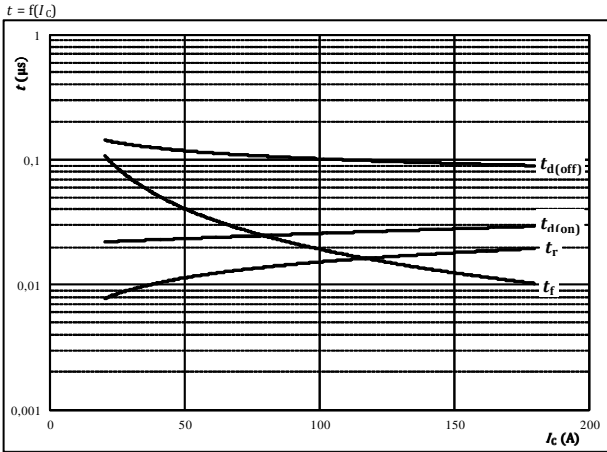

With an inductive load at

$T_j = 150$ °C
 $V_{CE} = 600$ V
 $V_{GE} = 0/16$ V
 $R_{gon} = 1$ Ω
 $R_{goff} = 1$ Ω

figure 6. IGBT

Typical switching times as a function of gate resistor

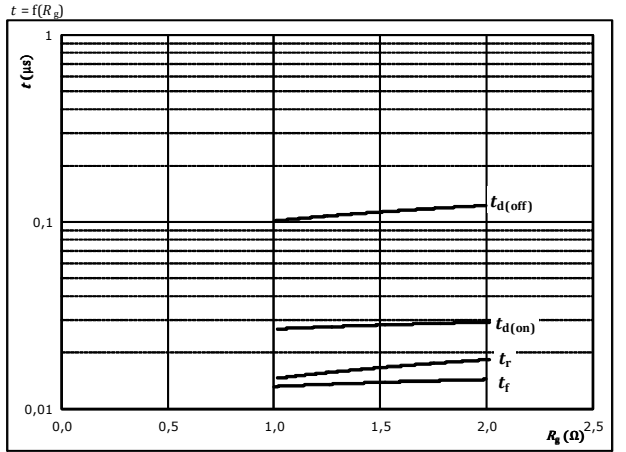

With an inductive load at

$T_j = 150$ °C
 $V_{CE} = 600$ V
 $V_{GE} = 0/16$ V
 $I_c = 99$ A

figure 7. FWD

Typical reverse recovery time as a function of collector current

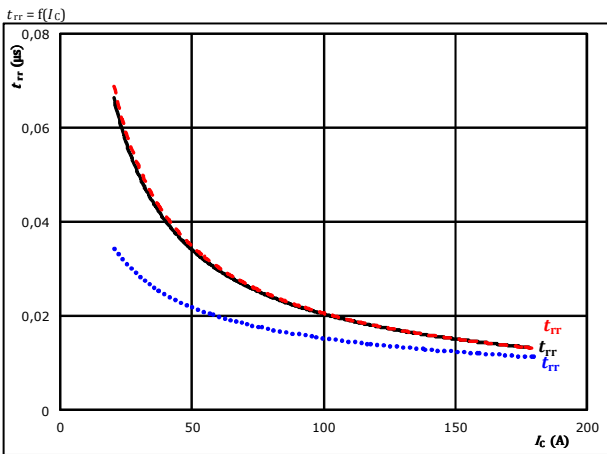

At $V_{CE} = 600$ V $T_j: 25$ °C
 $V_{GE} = 0/16$ V $T_j: 125$ °C ———
 $R_{gon} = 1$ Ω $T_j: 150$ °C - - - -

figure 8. FWD

Typical reverse recovery time as a function of IGBT turn on gate resistor

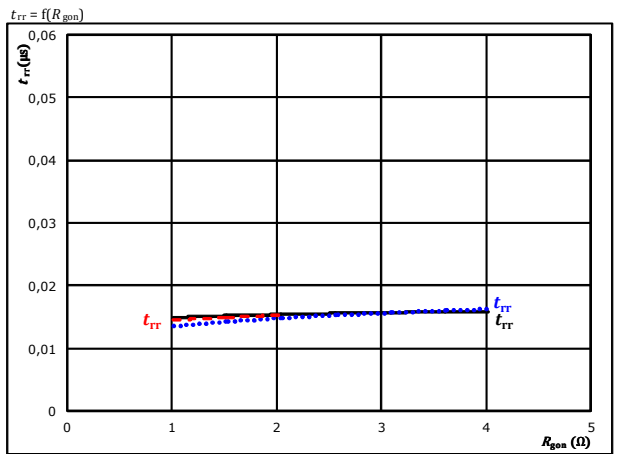

At $V_{CE} = 600$ V $T_j: 25$ °C
 $V_{GE} = 0/16$ V $T_j: 125$ °C ———
 $I_c = 99$ A $T_j: 150$ °C - - - -



AC Switching Characteristics

figure 9. FWD
 Typical recovered charge as a function of collector current

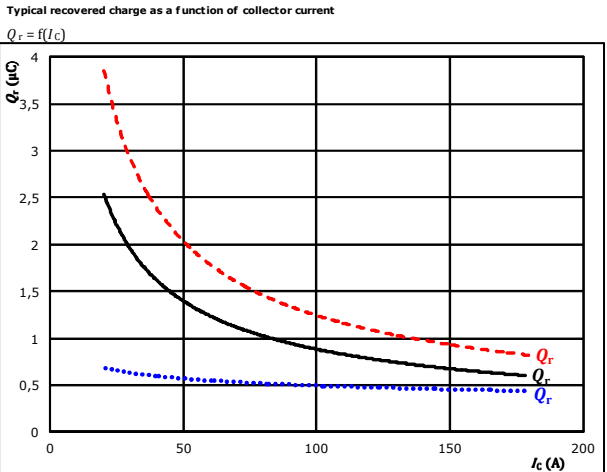

At $V_{CE} = 600$ V $T_j = 25$ °C (dotted blue line)
 $V_{GE} = 0/16$ V $T_j = 125$ °C (solid black line)
 $R_{ggn} = 1$ Ω $T_j = 150$ °C (dashed red line)

figure 10. FWD
 Typical recovered charge as a function of IGBT turn on gate resistor

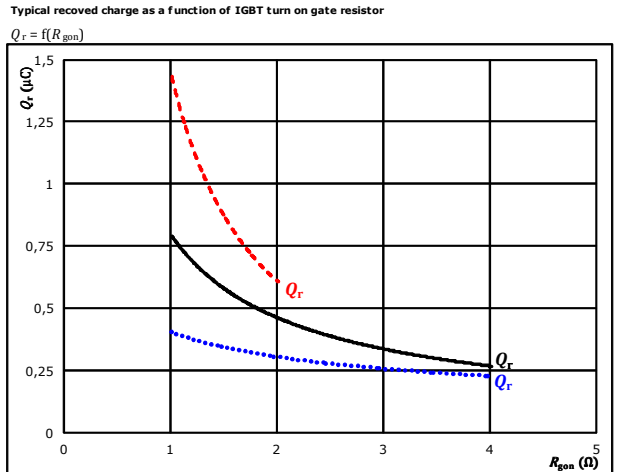

At $V_{CE} = 600$ V $T_j = 25$ °C (dotted blue line)
 $V_{GE} = 0/16$ V $T_j = 125$ °C (solid black line)
 $I_c = 99$ A $T_j = 150$ °C (dashed red line)

figure 11. FWD
 Typical peak reverse recovery current as a function of collector current

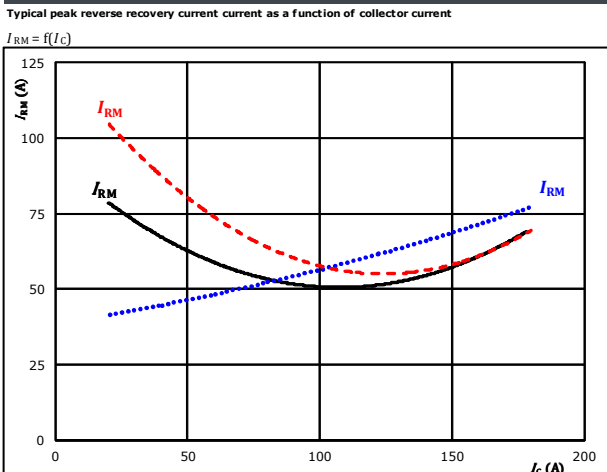

At $V_{CE} = 600$ V $T_j = 25$ °C (dotted blue line)
 $V_{GE} = 0/16$ V $T_j = 125$ °C (solid black line)
 $R_{ggn} = 1$ Ω $T_j = 150$ °C (dashed red line)

figure 12. FWD
 Typical peak reverse recovery current as a function of IGBT turn on gate resistor

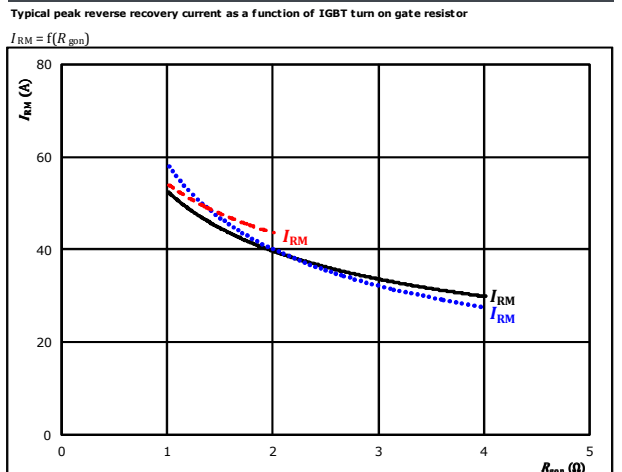

At $V_{CE} = 600$ V $T_j = 25$ °C (dotted blue line)
 $V_{GE} = 0/16$ V $T_j = 125$ °C (solid black line)
 $I_c = 99$ A $T_j = 150$ °C (dashed red line)



Vincotech

10-PH12NAB008MR02-LC59F38T
 10-PH12NAC008MR02-LC69F38T
 target datasheet

AC Switching Characteristics

figure 13. FWD

Typical rate of fall of forward and reverse recovery current as a function of collector current
 $di_f/dt, di_{rr}/dt = f(I_c)$

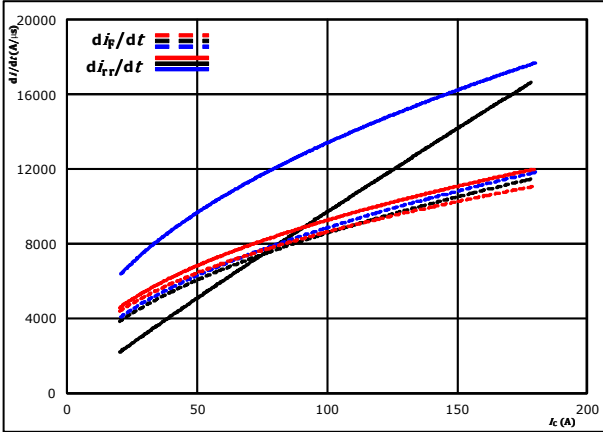

At $V_{CE} = 600$ V $T_j = 25$ °C (dotted blue)
 $V_{GE} = 0/16$ V $T_j = 125$ °C (solid black)
 $R_{g(on)} = 1$ Ω $T_j = 150$ °C (dashed red)

figure 14. FWD

Typical rate of fall of forward and reverse recovery current as a function of IGBT turn on gate resistor
 $di_f/dt, di_{rr}/dt = f(R_{g(on)})$

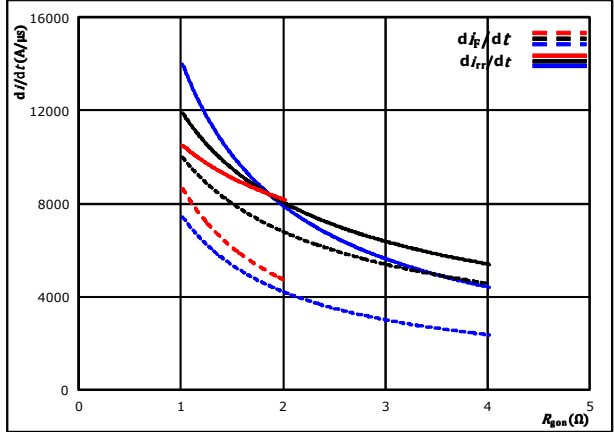

At $V_{CE} = 600$ V $T_j = 25$ °C (dotted blue)
 $V_{GE} = 0/16$ V $T_j = 125$ °C (solid black)
 $I_c = 99$ A $T_j = 150$ °C (dashed red)

figure 15. IGBT

Reverse bias safe operating area

$I_c = f(V_{CE})$

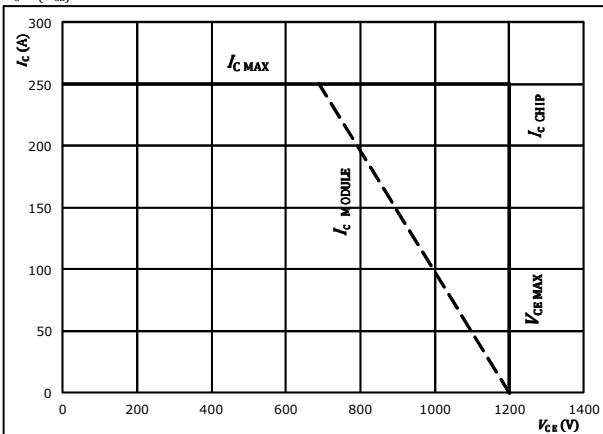

At $T_j = 175$ °C
 $R_{g(on)} = 1$ Ω
 $R_{g(off)} = 1$ Ω



AC Switching Definitions

General conditions

T_j	=	125 °C
R_{gon}	=	1 Ω
R_{goff}	=	1 Ω

figure 1. IGBT

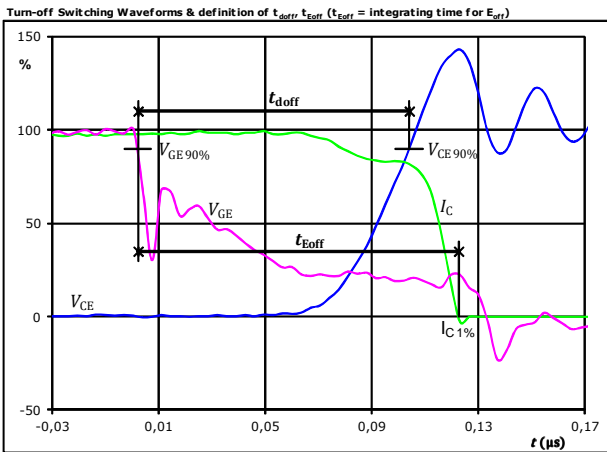

$V_{GE}(0\%) =$	0	V
$V_{GE}(100\%) =$	16	V
$V_C(100\%) =$	600	V
$I_C(100\%) =$	100	A
$t_{doff} =$	0,101	μ s
$t_{Eoff} =$	0,120	μ s

figure 2. IGBT

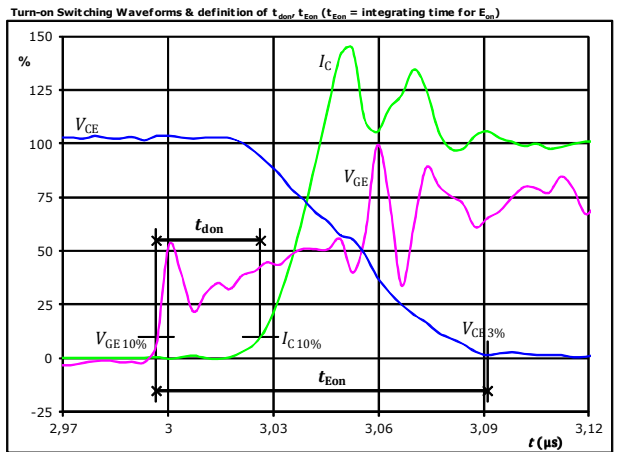

$V_{GE}(0\%) =$	0	V
$V_{GE}(100\%) =$	16	V
$V_C(100\%) =$	600	V
$I_C(100\%) =$	100	A
$t_{don} =$	0,029	μ s
$t_{Eon} =$	0,094	μ s

figure 3. IGBT

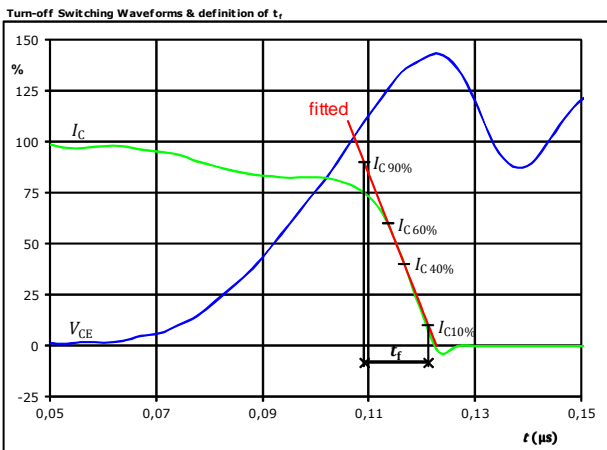

$V_C(100\%) =$	600	V
$I_C(100\%) =$	100	A
$t_f =$	0,013	μ s

figure 4. IGBT

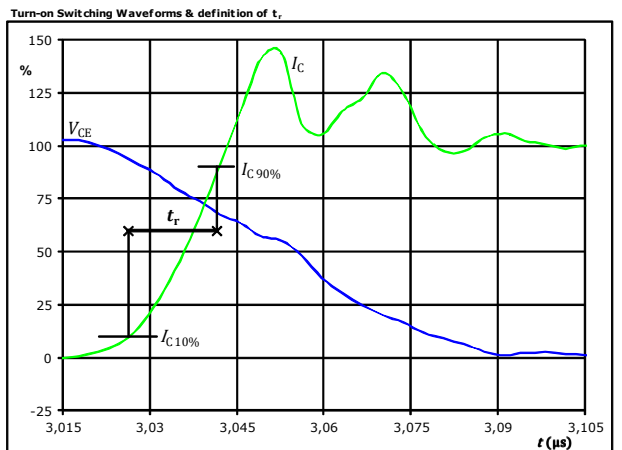

$V_C(100\%) =$	600	V
$I_C(100\%) =$	100	A
$t_r =$	0,015	μ s



Vincotech

10-PH12NAB008MR02-LC59F38T
10-PH12NAC008MR02-LC69F38T
 target datasheet

AC Switching Characteristics

figure 5. IGBT

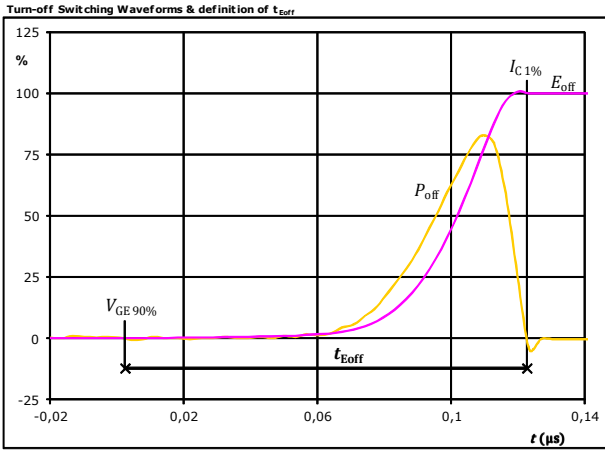

$P_{off}(100\%) = 60,18$ kW
 $E_{off}(100\%) = 1,42$ mJ
 $t_{Eoff} = 0,12$ μs

figure 6. IGBT

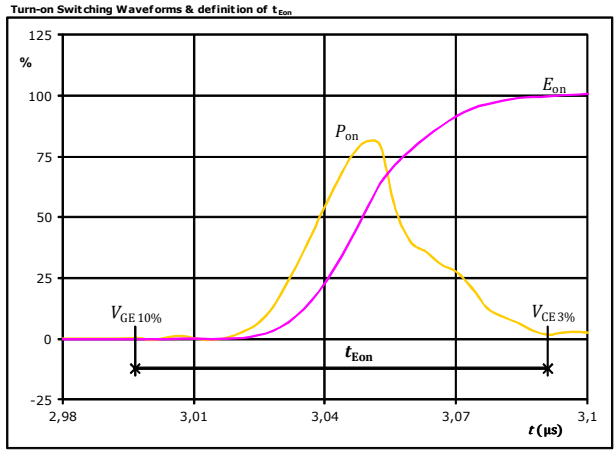

$P_{on}(100\%) = 60,18$ kW
 $E_{on}(100\%) = 1,44$ mJ
 $t_{Eon} = 0,09$ μs

figure 7. FWD

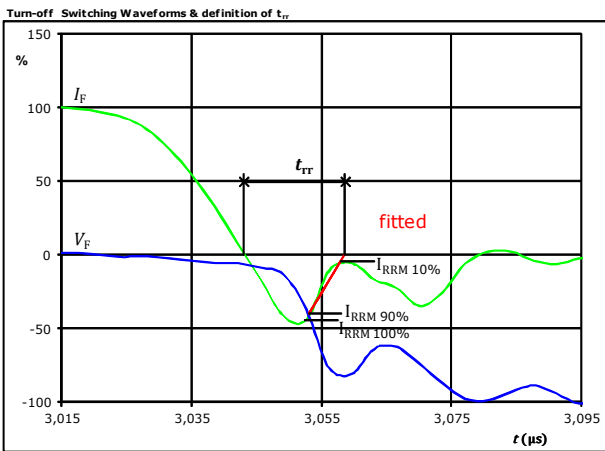

$V_F(100\%) = 600$ V
 $I_F(100\%) = 100$ A
 $I_{RRM}(100\%) = -51$ A
 $t_{rr} = 0,015$ μs



Vincotech

10-PH12NAB008MR02-LC59F38T
10-PH12NAC008MR02-LC69F38T
 target datasheet

AC Switching Characteristics

figure 8. FWD

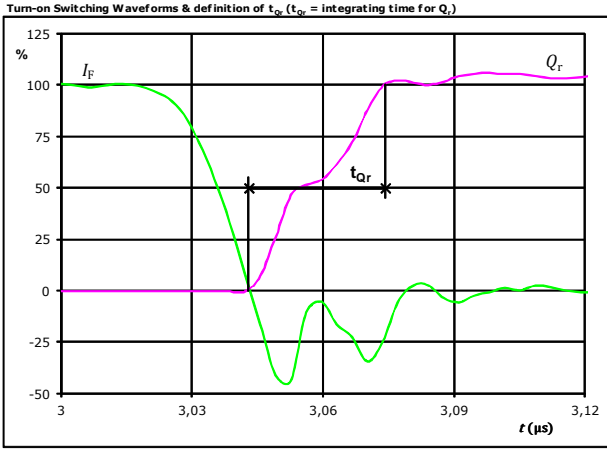

I_F (100%) =	100	A
Q_r (100%) =	0,79	μC
t_{Qr} =	0,03	μs

figure 9. FWD

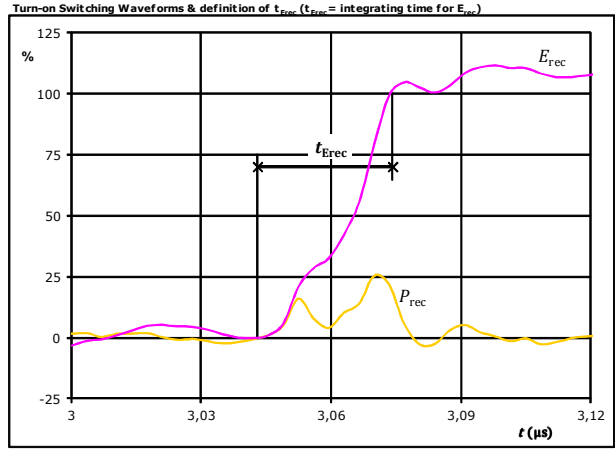

P_{rec} (100%) =	60,18	kW
E_{rec} (100%) =	0,22	mJ
t_{Erec} =	0,03	μs



Vincotech

10-PH12NAB008MR02-LC59F38T
10-PH12NAC008MR02-LC69F38T
 target datasheet

10-PH12NAB008MR02-LC59F38T

Ordering Code & Marking																																
Version				Ordering Code																												
without thermal paste 12 mm housing with press-fit pins				10-PH12NAB008MR02-LC59F38T																												
<table border="1"> <thead> <tr> <th rowspan="2">Text</th> <th colspan="2">Name</th> <th>Date code</th> <th>UL & VIN</th> <th>Lot</th> <th>Serial</th> </tr> <tr> <td colspan="2">NN-NNNNNNNNNNNNNN-TTTTTTW</td> <td>WWYY</td> <td>UL VIN</td> <td>LLLLL</td> <td>SSSS</td> </tr> </thead> <tbody> <tr> <td rowspan="2">Datamatrix</td> <td>Type&Ver</td> <td>Lot number</td> <td>Serial</td> <td>Date code</td> <td></td> <td></td> </tr> <tr> <td>TTTTTTW</td> <td>LLLLL</td> <td>SSSS</td> <td>WWYY</td> <td></td> <td></td> </tr> </tbody> </table>							Text	Name		Date code	UL & VIN	Lot	Serial	NN-NNNNNNNNNNNNNN-TTTTTTW		WWYY	UL VIN	LLLLL	SSSS	Datamatrix	Type&Ver	Lot number	Serial	Date code			TTTTTTW	LLLLL	SSSS	WWYY		
Text	Name		Date code	UL & VIN	Lot	Serial																										
	NN-NNNNNNNNNNNNNN-TTTTTTW		WWYY	UL VIN	LLLLL	SSSS																										
Datamatrix	Type&Ver	Lot number	Serial	Date code																												
	TTTTTTW	LLLLL	SSSS	WWYY																												

Pin table			
Pin	X	Y	Function
1			Not assembled
2	52,9	3	DC-1
3	49,9	3	DC-1
4	52,9	0	DC-1
5	49,9	0	DC-1
6			Not assembled
7	40	0	GND1
8	37	0	GND1
9			Not assembled
10			Not assembled
11	21,8	0	GND1
12	18,9	0	GND1
13			Not assembled
14	9	0	DC+1
15	6	0	DC+1
16	3	0	DC+1
17	0	0	DC+1
18	0	9,5	G11
19	0	12,5	S11
20	12,45	17,45	G13
21	15,45	18,45	S13
22	0	28,9	Therm11
23	3	28,9	Therm12
24			Not assembled
25			Not assembled
26			Not assembled
27			Not assembled
28			Not assembled
29			Not assembled
30			Not assembled
31			Not assembled
32	40,9	28,9	Ph1
33	43,9	28,9	Ph1
34	46,9	28,9	Ph1
35	49,9	28,9	Ph1
36	52,9	28,9	Ph1
37	44,3	17,9	N1
38	41,2	14,7	S15
39	38,2	14,7	G15
40	37,95	17,9	N1
41			Not assembled
42			Not assembled
43	29,35	18,5	P1
44	26,9	15,6	P1
45			Not assembled
46			Not assembled
47			Not assembled
48			Not assembled

Outline

center of press-fit pinhead
for connection parameter see the handling instruction

13.23 ± 0.1
16.4 ± 0.5

14.45
26.41

Tolerance of pinpositions: ±0.5mm at the end of pins
Dimension of coordinate axis is only offset without tolerance



Vincotech

10-PH12NAB008MR02-LC59F38T
10-PH12NAC008MR02-LC69F38T
 target datasheet

10-PH12NAB008MR02-LC59F38T

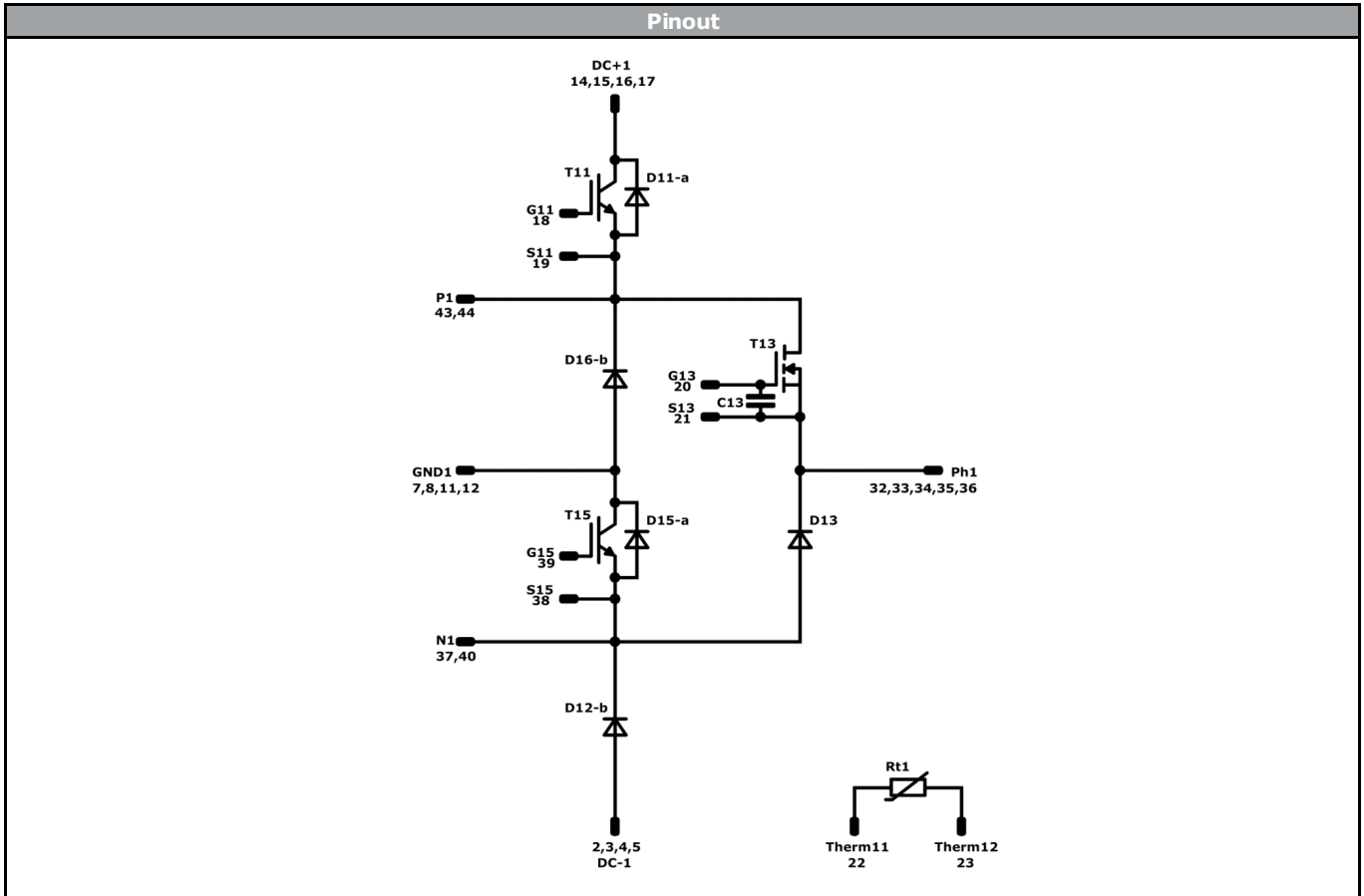

Identification					
ID	Component	Voltage	Current	Function	Comment
T11	IGBT	1200 V	150 A	DC-Link Switch	
D12-b	FWD	1200 V	100 A	DC-Link Diode	
D11-a	FWD	1200 V	100 A	DC-Link Switch Inverse Diode	
T15	IGBT	1200 V	150 A	Neutral Point Switch	
D16-b	FWD	1200 V	150 A	Neutral Point Diode	
D15-a	FWD	1200 V	15 A	Neutral Point Switch Prot. Diode	
T13	MOSFET	1200 V	8 mΩ	AC Switch	
D13	FWD	1200 V	60 A	AC Diode	
C13	Capacitor	25 V		GS Capacitor	
Rt1	NTC			Thermistor	



Vincotech

10-PH12NAB008MR02-LC59F38T
10-PH12NAC008MR02-LC69F38T
 target datasheet

10-PH12NAC008MR02-LC69F38T

Ordering Code & Marking						
Version				Ordering Code		
without thermal paste 12 mm housing with press-fit pins				10-PH12NAC008MR02-LC69F38T		
Text	Name		Date code	UL & VIN	Lot	Serial
	NN-NNNNNNNNNNNNNN-TTTTTTVV		WWYY	UL VIN	LLLLL	SSSS
Datamatrix	Type&Ver	Lot number	Serial	Date code		
	TTTTTTVV	LLLLL	SSSS	WWYY		

Pin table				Outline	
Pin	X	Y	Function		
1	52,9	6	Ph2		
2	52,9	3	Ph2		
3	49,9	3	Ph2		
4	52,9	0	Ph2		
5	49,9	0	Ph2		
6	Not assembled				
7	Not assembled				
8	Not assembled				
9	31,5	0	S14		
10	28,5	1	G14		
11	Not assembled				
12	Not assembled				
13	Not assembled				
14	Not assembled				
15	Not assembled				
16	3	0	Therm21		
17	0	0	Therm22		
18	0	9,5	S16		
19	0	12,5	G16		
20	Not assembled				
21	Not assembled				
22	0	28,9	DC+2		
23	3	28,9	DC+2		
24	6	28,9	DC+2		
25	9	28,9	DC+2		
26	Not assembled				
27	18,9	28,9	GND2		
28	21,8	28,9	GND2		
29	31	28,9	GND2		
30	34	28,9	GND2		
31	Not assembled				
32	Not assembled				
33	43,9	28,9	DC-2		
34	46,9	28,9	DC-2		
35	49,9	28,9	DC-2		
36	52,9	28,9	DC-2		
37	Not assembled				
38	Not assembled				
39	Not assembled				
40	Not assembled				
41	35,9	14,9	G12		
42	35,35	17,9	S12		
43	Not assembled				
44	26,9	15,6	N2		
45	26,9	13	N2		
46	Not assembled				
47	17,8	12,3	P2		
48	15,2	12,3	P2		

center of press-fit pinhead
for connection parameter see the handling instruction

19,23 ±0,1
16,4 ±0,5

14,45
Y

X
26,41

Tolerance of pinpositions: ±0,5mm at the end of pins
Dimension of coordinate axis is only offset without tolerance



Vincotech

10-PH12NAB008MR02-LC59F38T
10-PH12NAC008MR02-LC69F38T
 target datasheet

10-PH12NAC008MR02-LC69F38T

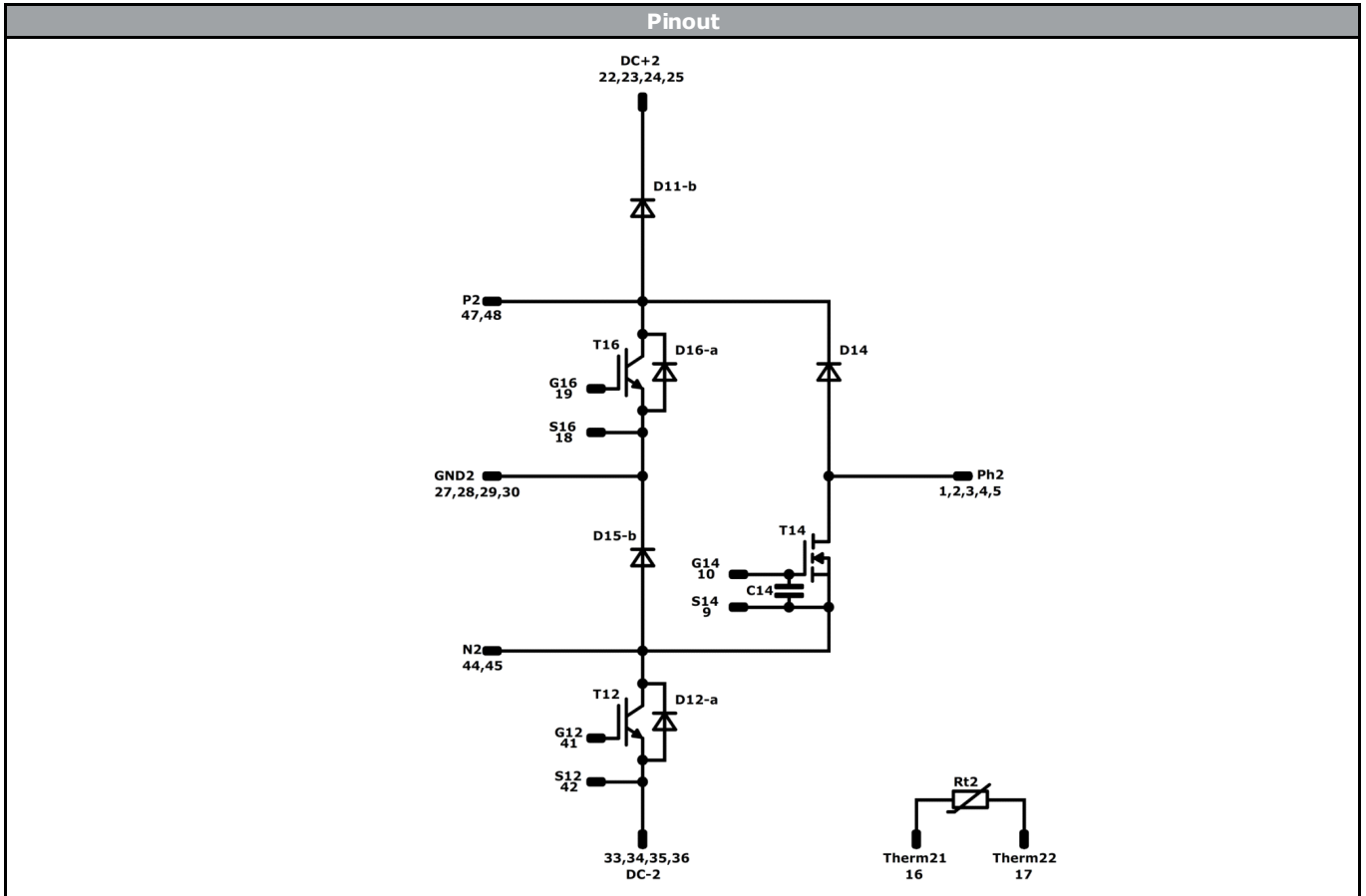

Identification

ID	Component	Voltage	Current	Function	Comment
T12	IGBT	1200 V	150 A	DC-Link Switch	
D11-b	FWD	1200 V	100 A	DC-Link Diode	
D12-a	FWD	1200 V	100 A	DC-Link Switch Inverse Diode	
T16	IGBT	1200 V	150 A	Neutral Point Switch	
D15-b	FWD	1200 V	150 A	Neutral Point Diode	
D16-a	FWD	1200 V	15 A	Neutral Point Switch Prot. Diode	
T14	MOSFET	1200 V	8 mΩ	AC Switch	
D14	FWD	1200 V	60 A	AC Diode	
C14	Capacitor	25 V		GS Capacitor	
Rt2	NTC			Thermistor	



Vincotech

Packaging instruction			
Standard packaging quantity (SPQ) 100	>SPQ	Standard	<SPQ Sample

Handling instruction
Handling instructions for <i>flow 1</i> packages see vincotech.com website.

Package data
Package data for <i>flow 1</i> packages see vincotech.com website.

UL recognition and file number
This device is certified according to UL 1557 standard, UL file number E192116. For more information see vincotech.com website. 

Document No.:	Date:	Modification:	Pages
10-PH12NAX008MR02-LCx9F38T-T2-14	19 Oct. 2017		

Product status definition		
Datasheet Status	Product Status	Definition
Target	Formative or In Design	This datasheet contains the design specifications for product development. Specifications may change in any manner without notice. The data contained is exclusively intended for technically trained staff.

DISCLAIMER

The information, specifications, procedures, methods and recommendations herein (together "information") are presented by Vincotech to reader in good faith, are believed to be accurate and reliable, but may well be incomplete and/or not applicable to all conditions or situations that may exist or occur. Vincotech reserves the right to make any changes without further notice to any products to improve reliability, function or design. No representation, guarantee or warranty is made to reader as to the accuracy, reliability or completeness of said information or that the application or use of any of the same will avoid hazards, accidents, losses, damages or injury of any kind to persons or property or that the same will not infringe third parties rights or give desired results. It is reader's sole responsibility to test and determine the suitability of the information and the product for reader's intended use.

LIFE SUPPORT POLICY

Vincotech products are not authorised for use as critical components in life support devices or systems without the express written approval of Vincotech.

As used herein:

1. Life support devices or systems are devices or systems which, (a) are intended for surgical implant into the body, or (b) support or sustain life, or (c) whose failure to perform when properly used in accordance with instructions for use provided in labelling can be reasonably expected to result in significant injury to the user.
2. A critical component is any component of a life support device or system whose failure to perform can be reasonably expected to cause the failure of the life support device or system, or to affect its safety or effectiveness.

单击下面可查看定价，库存，交付和生命周期等信息

[>>Vincotech\(威科\)](#)