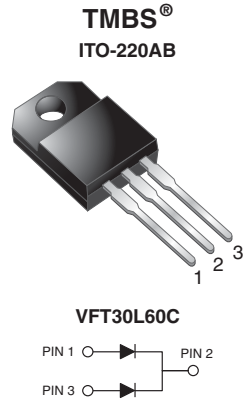


## Dual Trench MOS Barrier Schottky Rectifier

 Ultra Low  $V_F = 0.32\text{ V}$  at  $I_F = 5.0\text{ A}$ 


### FEATURES

- Trench MOS Schottky technology
- Low forward voltage drop, low power losses
- High efficiency operation
- Solder dip 275 °C max. 10 s, per JESD 22-B106
- Material categorization: for definitions of compliance please see [www.vishay.com/doc?99912](http://www.vishay.com/doc?99912)


**RoHS**  
 COMPLIANT  
 HALOGEN  
**FREE**

### TYPICAL APPLICATIONS

For use in high frequency converters, switching power supplies, freewheeling diodes, OR-ing diode, DC/DC converters, and reverse battery protection.

### MECHANICAL DATA

**Case:** ITO-220AB

Molding compound meets UL 94 V-0 flammability rating  
 Base P/N-M3 - halogen-free, RoHS-compliant, and commercial grade

**Terminals:** matte tin plated leads, solderable per J-STD-002 and JESD 22-B102

M3 suffix meets JESD 201 class 1A whisker test

**Polarity:** as marked

**Mounting Torque:** 10 in-lbs maximum

PRIMARY CHARACTERISTICS	
$I_{F(AV)}$	2 x 15 A
$V_{RRM}$	60 V
$I_{FSM}$	200 A
$V_F$ at $I_F = 15\text{ A}$	0.45 V
$T_J$ max.	150 °C
Package	ITO-220AB
Circuit configuration	Common cathode

MAXIMUM RATINGS ( $T_A = 25\text{ °C}$ unless otherwise noted)			
PARAMETER	SYMBOL	VFT30L60C	UNIT
Maximum repetitive peak reverse voltage	$V_{RRM}$	60	V
Maximum average forward rectified current (fig. 1)	$I_{F(AV)}$	per device	30
		per diode	15
Peak forward surge current 8.3 ms single half sine-wave superimposed on rated load	$I_{FSM}$	200	A
Voltage rate of change (rated $V_R$ )	$dV/dt$	10 000	V/ $\mu$ s
Isolation voltage from terminal to heatsink $t = 1\text{ min}$	$V_{AC}$	1500	V
Operating junction and storage temperature range	$T_J, T_{STG}$	-40 to +150	°C

<b>ELECTRICAL CHARACTERISTICS</b> ( $T_A = 25\text{ }^\circ\text{C}$ unless otherwise noted)						
PARAMETER	TEST CONDITIONS	SYMBOL	TYP.	MAX.	UNIT	
Instantaneous forward voltage per diode	$I_F = 5.0\text{ A}$	$T_A = 25\text{ }^\circ\text{C}$	$V_F^{(1)}$	0.43	-	V
	$I_F = 7.5\text{ A}$			0.46	-	
	$I_F = 15\text{ A}$			0.51	0.60	
	$I_F = 5.0\text{ A}$	$T_A = 125\text{ }^\circ\text{C}$		0.32	-	
	$I_F = 7.5\text{ A}$			0.36	-	
	$I_F = 15\text{ A}$			0.45	0.57	
Reverse current per diode	$V_R = 60\text{ V}$	$T_A = 25\text{ }^\circ\text{C}$	$I_R^{(2)}$	-	4.0	mA
		$T_A = 125\text{ }^\circ\text{C}$		27	110	

**Notes**

- (1) Pulse test: 300  $\mu\text{s}$  pulse width, 1 % duty cycle  
 (2) Pulse test: Pulse width  $\leq 40\text{ ms}$

<b>THERMAL CHARACTERISTICS</b> ( $T_A = 25\text{ }^\circ\text{C}$ unless otherwise noted)				
PARAMETER		SYMBOL	VFT30L60C	UNIT
Typical thermal resistance	per diode	$R_{\theta JC}$	5.0	$^\circ\text{C/W}$
	per device		3.5	

<b>ORDERING INFORMATION</b> (Example)					
PACKAGE	PREFERRED P/N	UNIT WEIGHT (g)	PACKAGE CODE	BASE QUANTITY	DELIVERY MODE
ITO-220AB	VFT30L60C-M3/4W	1.76	4W	50/tube	Tube

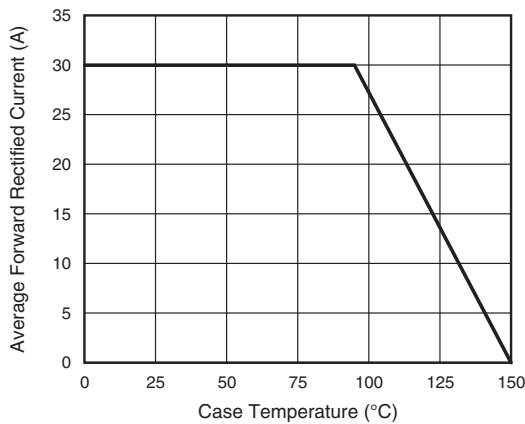
**RATINGS AND CHARACTERISTICS CURVES** ( $T_A = 25\text{ }^\circ\text{C}$  unless otherwise noted)


Fig. 1 - Maximum Forward Current Derating Curve

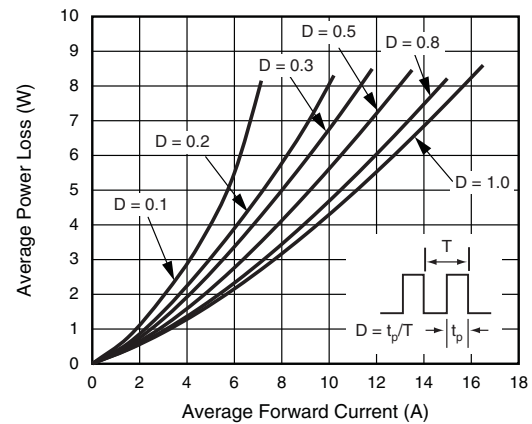


Fig. 2 - Forward Power Dissipation Characteristics Per Diode

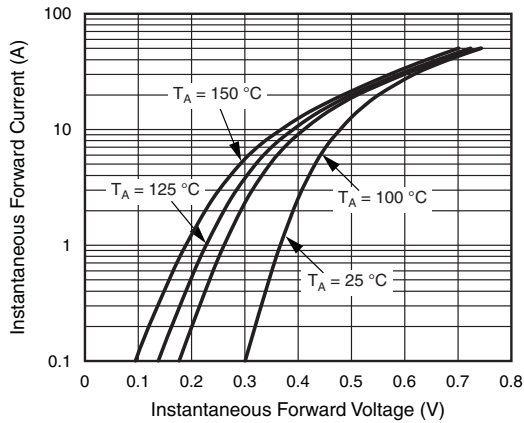


Fig. 3 - Typical Instantaneous Forward Characteristics Per Diode

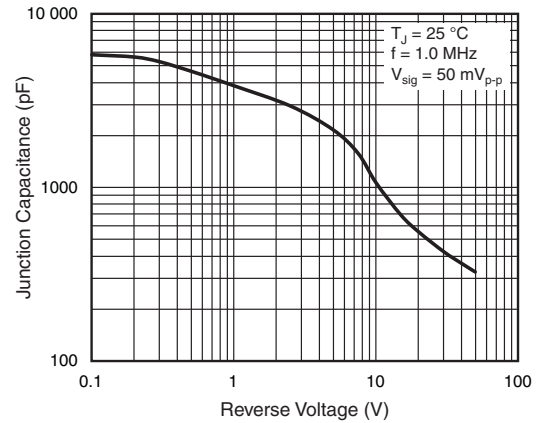


Fig. 5 - Typical Transient Thermal Impedance Per Diode

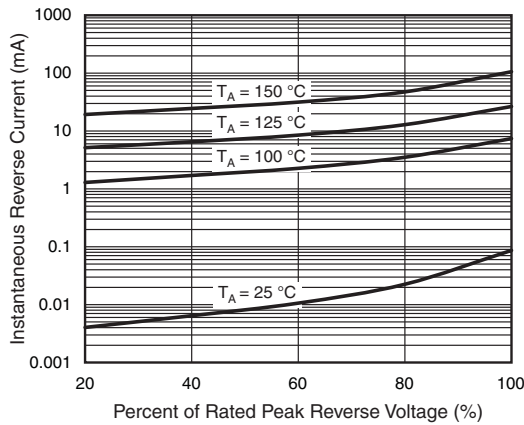


Fig. 4 - Typical Reverse Characteristics Per Diode

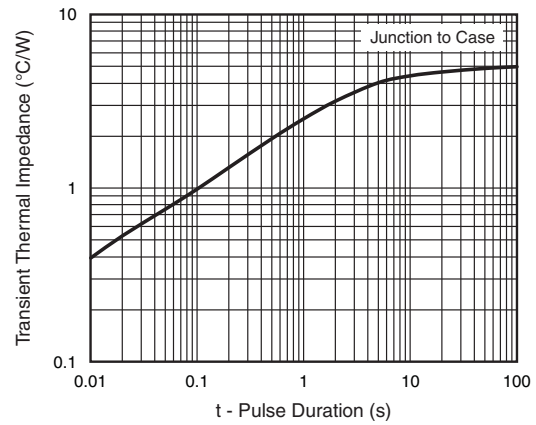
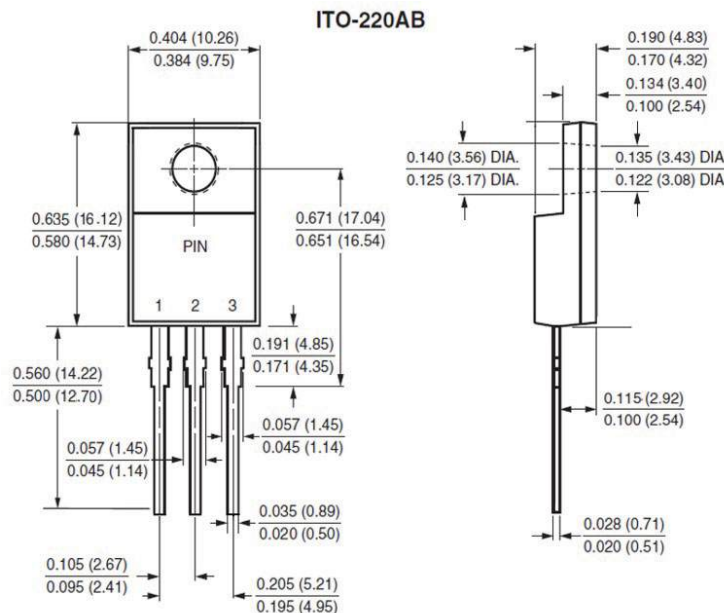


Fig. 6 - Typical Junction Capacitance Per Diode

**PACKAGE OUTLINE DIMENSIONS** in inches (millimeters)





## Disclaimer

ALL PRODUCT, PRODUCT SPECIFICATIONS AND DATA ARE SUBJECT TO CHANGE WITHOUT NOTICE TO IMPROVE RELIABILITY, FUNCTION OR DESIGN OR OTHERWISE.

Vishay Intertechnology, Inc., its affiliates, agents, and employees, and all persons acting on its or their behalf (collectively, "Vishay"), disclaim any and all liability for any errors, inaccuracies or incompleteness contained in any datasheet or in any other disclosure relating to any product.

Vishay makes no warranty, representation or guarantee regarding the suitability of the products for any particular purpose or the continuing production of any product. To the maximum extent permitted by applicable law, Vishay disclaims (i) any and all liability arising out of the application or use of any product, (ii) any and all liability, including without limitation special, consequential or incidental damages, and (iii) any and all implied warranties, including warranties of fitness for particular purpose, non-infringement and merchantability.

Statements regarding the suitability of products for certain types of applications are based on Vishay's knowledge of typical requirements that are often placed on Vishay products in generic applications. Such statements are not binding statements about the suitability of products for a particular application. It is the customer's responsibility to validate that a particular product with the properties described in the product specification is suitable for use in a particular application. Parameters provided in datasheets and / or specifications may vary in different applications and performance may vary over time. All operating parameters, including typical parameters, must be validated for each customer application by the customer's technical experts. Product specifications do not expand or otherwise modify Vishay's terms and conditions of purchase, including but not limited to the warranty expressed therein.

Hyperlinks included in this datasheet may direct users to third-party websites. These links are provided as a convenience and for informational purposes only. Inclusion of these hyperlinks does not constitute an endorsement or an approval by Vishay of any of the products, services or opinions of the corporation, organization or individual associated with the third-party website. Vishay disclaims any and all liability and bears no responsibility for the accuracy, legality or content of the third-party website or for that of subsequent links.

Except as expressly indicated in writing, Vishay products are not designed for use in medical, life-saving, or life-sustaining applications or for any other application in which the failure of the Vishay product could result in personal injury or death. Customers using or selling Vishay products not expressly indicated for use in such applications do so at their own risk. Please contact authorized Vishay personnel to obtain written terms and conditions regarding products designed for such applications.

No license, express or implied, by estoppel or otherwise, to any intellectual property rights is granted by this document or by any conduct of Vishay. Product names and markings noted herein may be trademarks of their respective owners.

单击下面可查看定价，库存，交付和生命周期等信息

[>>Vishay\(威世\)](#)