

EMIPAK-2B PressFit Power Module Double Interleaved Boost Converter, 15 A



EMIPAK-2B
(package example)

FEATURES

- Trench IGBT technology
- HEXFRED clamping diode technology
- Rectifier bypass diode
- PressFit pins technology
- Exposed Al₂O₃ substrate with low thermal resistance
- Integrated thermistor
- 10 μs short circuit capability
- Square RBSOA
- Low internal inductances
- Low switching loss
- PressFit pins locking technology. Patent # US.263.820 B2
- UL approved file E78996
- Material categorization: for definitions of compliance please see www.vishay.com/doc?99912



RoHS
COMPLIANT

PRODUCT SUMMARY

RECTIFIER BYPASS DIODE	
V_{RRM}	1200 V
V_{FM} typical at $I_F = 20$ A	1.04 V
I_F at $T_C = 80$ °C	62 A
PFC IGBT	
V_{CES}	1200 V
$V_{CE(ON)}$ typical at $I_C = 15$ A	2.61 V
I_C at $T_C = 80$ °C	15 A
Speed (max.)	20 kHz
Speed	8 kHz to 30 kHz
Package	EMIPAK-2B
Circuit	Double interleaved boost converter

DESCRIPTION

VS-ETL015Y120H is an integrated solution for a double interleaved boost converter. The EMIPAK-2B package is easy to use thanks to the PressFit pins and the exposed substrate provides improved thermal performance. The optimized layout also helps to minimize stray parameters, allowing for better EMI performance.

ABSOLUTE MAXIMUM RATINGS

PARAMETER	SYMBOL	TEST CONDITIONS	MAX.	UNITS
Operating junction temperature	T_J		150	°C
Storage temperature range	T_{Stg}		-40 to +150	
RMS isolation voltage	V_{ISOL}	$T_J = 25$ °C, all terminals shorted, $f = 50$ Hz, $t = 1$ s	3500	V
DbpA - DbpB BYPASS DIODE				
Repetitive peak reverse voltage	V_{RRM}		1200	V
Continuous output current	I_F	$T_C = 25$ °C	94	A
		$T_C = 80$ °C	62	
		$T_{SINK} = 80$ °C	39	
Surge current (non- repetitive)	I_{FSM}	Rated V_{RRM} applied	250	
Power dissipation	P_D	$T_C = 25$ °C	167	W
		$T_C = 80$ °C	93	

PATENT(S): www.vishay.com/patents

This Vishay product is protected by one or more United States and International patents.



ABSOLUTE MAXIMUM RATINGS				
PARAMETER	SYMBOL	TEST CONDITIONS	MAX.	UNITS
Ta1 - Ta2 - Tb1 - Tb2 PFC IGBT				
Collector to emitter voltage	V_{CES}		1200	V
Gate to emitter voltage	V_{GES}		20	
Pulsed collector current	I_{CM}		40	A
Clamped inductive load current	$I_{LM}^{(1)}$		40	
Continuous collector current	I_C	$T_C = 25\text{ }^\circ\text{C}$	22	A
		$T_C = 80\text{ }^\circ\text{C}$	15	
		$T_{SINK} = 80\text{ }^\circ\text{C}$	11	
Power dissipation	P_D	$T_C = 25\text{ }^\circ\text{C}$	89	W
		$T_C = 80\text{ }^\circ\text{C}$	50	
Da1 - Da2 - Db1 - Db2 CLAMPING DIODE				
Repetitive peak reverse voltage	V_{RRM}		1200	V
Single pulse forward current	I_{FSM}	10 ms sine or 6 ms rectangular pulse, $T_J = 25\text{ }^\circ\text{C}$	95	A
Diode continuous forward current	I_F	$T_C = 25\text{ }^\circ\text{C}$	22	
		$T_C = 80\text{ }^\circ\text{C}$	14	
		$T_{SINK} = 80\text{ }^\circ\text{C}$	10	
Power dissipation	P_D	$T_C = 25\text{ }^\circ\text{C}$	80	W
		$T_C = 80\text{ }^\circ\text{C}$	45	
DTa1 - DTa2 - DTb1 - DTb2 AP DIODE				
Single pulse forward current	I_{FSM}	10 ms sine or 6 ms rectangular pulse, $T_J = 25\text{ }^\circ\text{C}$	95	A
Diode continuous forward current	I_F	$T_C = 25\text{ }^\circ\text{C}$	22	
		$T_C = 80\text{ }^\circ\text{C}$	14	
		$T_{SINK} = 80\text{ }^\circ\text{C}$	10	
Power dissipation	P_D	$T_C = 25\text{ }^\circ\text{C}$	80	W
		$T_C = 80\text{ }^\circ\text{C}$	45	

Notes

- Absolute Maximum Ratings indicate sustained limits beyond which damage to the device may occur.
- (1) $V_{CC} = 600\text{ V}$, $V_{GE} = 15\text{ V}$, $L = 500\text{ }\mu\text{H}$, $R_g = 4.7\text{ }\Omega$, $T_J = 150\text{ }^\circ\text{C}$

ELECTRICAL SPECIFICATIONS ($T_J = 25\text{ }^\circ\text{C}$ unless otherwise noted)						
PARAMETER	SYMBOL	TEST CONDITIONS	MIN.	TYP.	MAX.	UNITS
DbpA - DbpB BYPASS DIODE						
Reverse leakage current	I_{RRM}	$V_{RRM} = 1200\text{ V}$	-	-	0.14	mA
		$V_{RRM} = 1200\text{ V}$, $T_J = 150\text{ }^\circ\text{C}$	-	-	3.0	
Forward voltage drop	V_{FM}	$I_F = 20\text{ A}$	-	1.04	1.23	V
		$I_F = 20\text{ A}$, $T_J = 150\text{ }^\circ\text{C}$	-	0.95	-	
Forward slope resistance	r_t	$T_J = 150\text{ }^\circ\text{C}$	-	-	6.6	$\text{m}\Omega$
Conduction threshold voltage	V_T		-	-	0.73	V
Ta1 - Ta2 - Tb1 - Tb2 PFC IGBT						
Collector to emitter breakdown voltage	BV_{CES}	$V_{GE} = 0\text{ V}$, $I_C = 250\text{ }\mu\text{A}$	1200	-	-	V
Collector to emitter voltage	$V_{CE(ON)}$	$V_{GE} = 15\text{ V}$, $I_C = 15\text{ A}$	-	2.61	3.03	
		$V_{GE} = 15\text{ V}$, $I_C = 15\text{ A}$, $T_J = 125\text{ }^\circ\text{C}$	-	3.05	-	
Gate threshold voltage	$V_{GE(th)}$	$V_{CE} = V_{GE}$, $I_C = 400\text{ }\mu\text{A}$	4.5	5.8	8.1	
Temperature coefficient of threshold voltage	$\Delta V_{GE(th)}/\Delta T_J$	$V_{CE} = V_{GE}$, $I_C = 1.0\text{ mA}$ ($25\text{ }^\circ\text{C}$ to $125\text{ }^\circ\text{C}$)	-	-14	-	$\text{mV}/^\circ\text{C}$
Forward transconductance	g_{fe}	$V_{CE} = 20\text{ V}$, $I_C = 15\text{ A}$	-	8	-	S
Transfer characteristics	V_{GE}	$V_{CE} = 20\text{ V}$, $I_C = 15\text{ A}$	-	10	-	V
Zero gate voltage collector current	I_{CES}	$V_{GE} = 0\text{ V}$, $V_{CE} = 1200\text{ V}$	-	0.0003	0.075	mA
		$V_{GE} = 0\text{ V}$, $V_{CE} = 1200\text{ V}$, $T_J = 125\text{ }^\circ\text{C}$	-	0.24	-	
Gate to emitter leakage current	I_{GES}	$V_{GE} = \pm 20\text{ V}$, $V_{CE} = 0\text{ V}$	-	-	± 200	nA



ELECTRICAL SPECIFICATIONS (T _J = 25 °C unless otherwise noted)						
Da1 - Da2 - Db1 - Db2 CLAMPING DIODE						
PARAMETER	SYMBOL	TEST CONDITIONS	MIN.	TYP.	MAX.	UNITS
Cathode to anode blocking voltage	V _{BR}	I _R = 100 μA	1200	-	-	V
Forward voltage drop	V _{FM}	I _F = 10 A	-	2.09	2.77	
		I _F = 10 A, T _J = 125 °C	-	2.16	-	
Reverse leakage current	I _{RM}	V _R = 1200 V	-	0.0004	0.075	mA
		V _R = 1200 V, T _J = 125 °C	-	0.25	-	
DTa1 - DTa2 - DTb1 - DTb2 AP DIODE						
Forward voltage drop	V _{FM}	I _F = 20 A	-	2.59	3.25	V
		I _F = 20 A T _J = 125 °C	-	2.86	-	

SWITCHING CHARACTERISTICS (T _J = 25 °C unless otherwise noted)						
PARAMETER	SYMBOL	TEST CONDITIONS	MIN.	TYP.	MAX.	UNITS
PFC IGBT (WITH FREEWHEELING CLAMPING DIODE)						
Total gate charge (turn-on)	Q _g	I _C = 9 A	-	45	-	nC
Gate to emitter charge (turn-on)	Q _{ge}	V _{CC} = 600 V	-	8.7	-	
Gate to collector charge (turn-on)	Q _{gc}	V _{GE} = 15 V	-	20	-	
Turn-on switching loss	E _{ON}	I _C = 15 A V _{CC} = 600 V V _{GE} = 15 V R _g = 4.7 Ω L = 500 μH ⁽¹⁾	-	0.95	-	mJ
Turn-off switching loss	E _{OFF}		-	0.47	-	
Total switching loss	E _{TOT}		-	1.42	-	
Turn-on delay time	t _{d(on)}		-	23	-	ns
Rise time	t _r		-	22	-	
Turn-off delay time	t _{d(off)}		-	58	-	
Fall time	t _f		-	178	-	
Turn-on switching loss	E _{ON}	I _C = 15 A V _{CC} = 600 V V _{GE} = 15 V R _g = 4.7 Ω L = 500 μH T _J = 125 °C ⁽¹⁾	-	1.18	-	mJ
Turn-off switching loss	E _{OFF}		-	0.72	-	
Total switching loss	E _{TOT}		-	1.89	-	
Turn-on delay time	t _{d(on)}		-	24	-	ns
Rise time	t _r		-	23	-	
Turn-off delay time	t _{d(off)}		-	60	-	
Fall time	t _f		-	219	-	
Input capacitance	C _{ies}	V _{GE} = 0 V	-	1070	-	pF
Output capacitance	C _{oes}	V _{CC} = 30 V	-	63	-	
Reverse transfer capacitance	C _{res}	f = 1 MHz	-	26	-	
Reverse bias safe operating area	RBSOA	T _J = 150 °C, I _C = 40 A, V _{CC} = 600 V, V _P = 1200 V, R _g = 4.7 Ω, V _{GE} = 15 V to 0 V	Fullsquare			
Short circuit safe operating area	SCSOA	R _g = 22 Ω, V _{CC} = 900 V, V _P = 1200 V, V _{GE} = 15 V to 0	-	-	10	μs
Da1 - Da2 - Db1 - Db2 CLAMPING DIODE						
Diode reverse recovery time	t _{rr}	V _R = 400 V	-	103	-	ns
Diode peak reverse current	I _{rr}	I _F = 10 A	-	14	-	A
Diode recovery charge	Q _{rr}	di/dt = 500 A/μs	-	711	-	nC
Diode reverse recovery time	t _{rr}	V _R = 400 V	-	126	-	ns
Diode peak reverse current	I _{rr}	I _F = 10 A	-	17	-	A
Diode recovery charge	Q _{rr}	di/dt = 500 A/μs, T _J = 125 °C	-	1047	-	nC



SWITCHING CHARACTERISTICS (T _J = 25 °C unless otherwise noted)						
PARAMETER	SYMBOL	TEST CONDITIONS	MIN.	TYP.	MAX.	UNITS
DTa1 - DTa2 - DTb1 - DTb2 AP DIODE						
Diode reverse recovery time	t _{rr}	V _R = 400 V I _F = 20 A dI/dt = 500 A/μs	-	127	-	ns
Diode peak reverse current	I _{rr}		-	16	-	A
Diode recovery charge	Q _{rr}		-	1020	-	nC
Diode reverse recovery time	t _{rr}	V _R = 400 V I _F = 20 A dI/dt = 500 A/μs, T _J = 125 °C	-	153	-	ns
Diode peak reverse current	I _{rr}		-	19	-	A
Diode recovery charge	Q _{rr}		-	1464	-	nC

Note

(1) Energy losses include “tail” and diode reverse recovery.

INTERNAL NTC - THERMISTOR SPECIFICATIONS				
PARAMETER	SYMBOL	TEST CONDITIONS	VALUE	UNITS
Resistance	R ₂₅	T _C = 25 °C	5000	Ω
	R ₁₀₀	T _C = 100 °C	493 ± 5 %	
B-value	B _{25/50}	R ₂ = R ₂₅ exp. [B _{25/50} (1/T ₂ - 1/(298.15 K))]	3375 ± 5 %	K
Maximum operating temperature			220	°C
Dissipation constant			2	mW/°C
Thermal time constant			8	s

THERMAL AND MECHANICAL SPECIFICATIONS					
PARAMETER	SYMBOL	MIN.	TYP.	MAX.	UNITS
DbpA - DbpB Bypass diode - Junction to case thermal resistance (per diode)	R _{thJC}	-	-	0.75	°C/W
Ta1 - Ta2 - Tb1 - Tb2 PFC IGBT - Junction to case thermal resistance (per switch)		-	-	1.4	
Da1 - Da2 - Db1 - Db2 Clamping diode - Junction to case thermal resistance (per diode)		-	-	1.56	
DTa1 - DTa2 - DTb1 - DTb2 AP diode - Junction to case thermal resistance (per diode)		-	-	1.56	
DbpA - DbpB Bypass diode - Case to sink thermal resistance (per diode)	R _{thCS} ⁽¹⁾	-	0.63	-	
Ta1 - Ta2 - Tb1 - Tb2 PFC IGBT - Case to sink thermal resistance (per switch)		-	0.96	-	
Da1 - Da2 - Db1 - Db2 Clamping diode - Case to sink thermal resistance (per diode)		-	1.1	-	
DTa1 - DTa2 - DTb1 - DTb2 AP diode - Case to sink thermal resistance (per diode)		-	1.1	-	
Case to sink thermal resistance per module		-	0.1	-	
Mounting torque (M4)		2	-	3	
Weight		-	45	-	g

Note

(1) Mounting surface flat, smooth, and greased

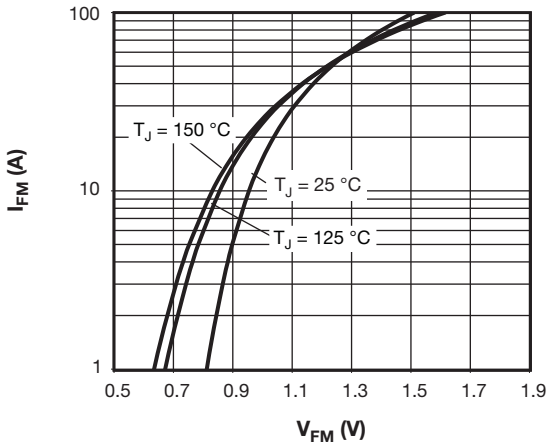

Fig. 1 - Typical DbpA -DbpB Bypass Diode Forward Characteristics

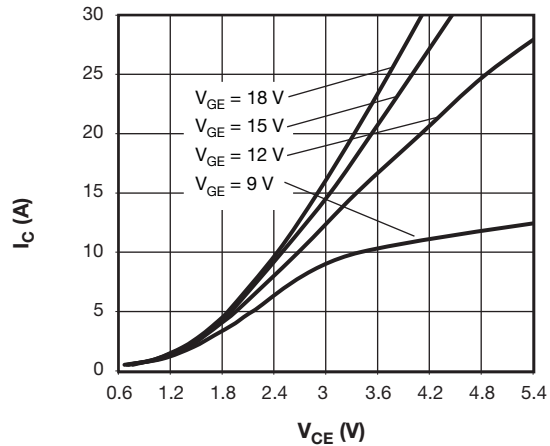
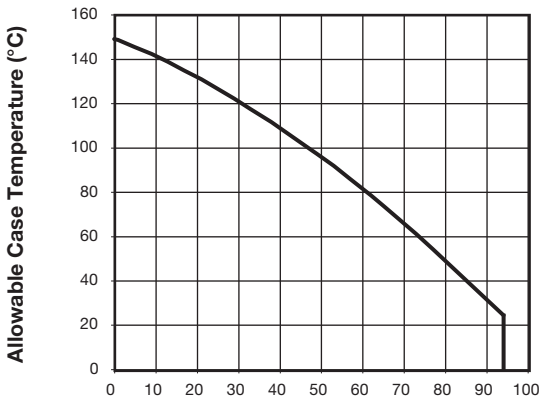
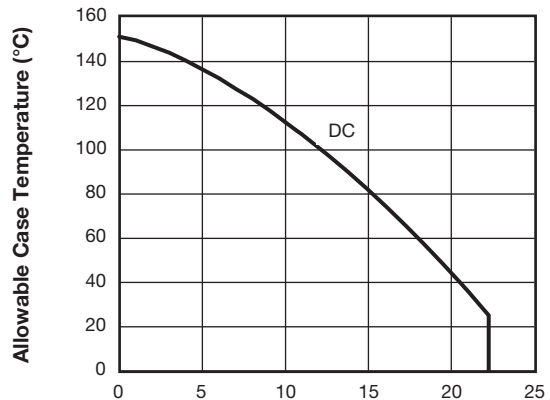

Fig. 4 - Typical Ta1 - Ta2 - Tb1 - Tb2 PFC IGBT Output Characteristics, T_J = 125 °C



I_F - Continuous Forward Current (A)
Fig. 2 - Maximum DbpA -DbpB Bypass Diode Forward Current vs. Case Temperature



I_C - Continuous Collector Current (A)
Fig. 5 - Maximum Ta1 - Ta2 - Tb1 - Tb2 PFC IGBT Continuous Collector Current vs. Case Temperature

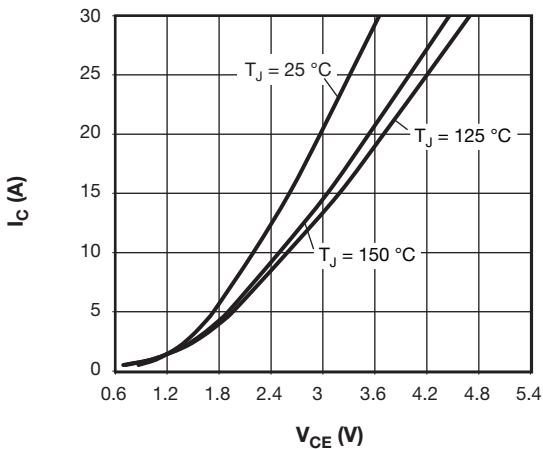

Fig. 3 - Typical Ta1 - Ta2 - Tb1 - Tb2 PFC IGBT Output Characteristics, V_{GE} = 15 V

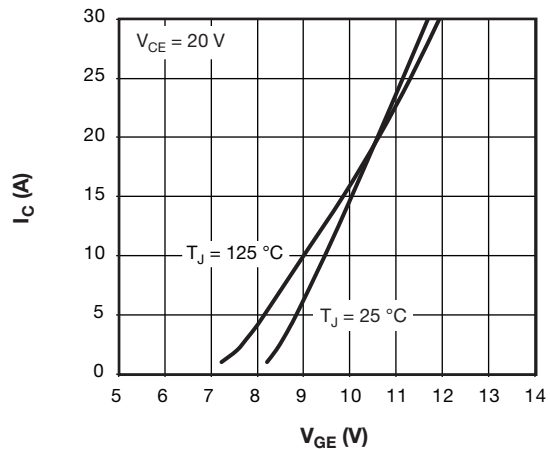

Fig. 6 - Typical Ta1 - Ta2 - Tb1 - Tb2 PFC IGBT Transfer Characteristics

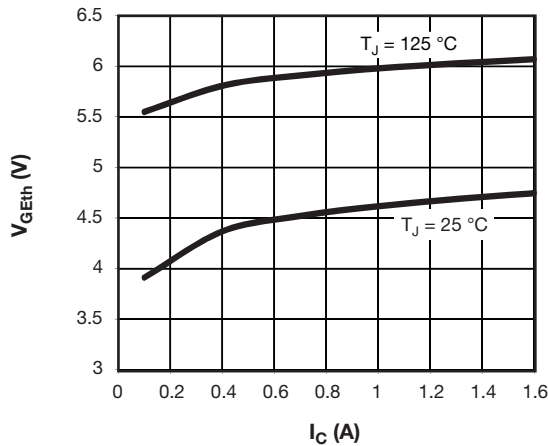

Fig. 7 - Typical Q1 - Q4 Trench IGBT Energy Loss vs. I_C (with D5 - D6 Clamping Diode)
 $T_J = 125\text{ °C}$, $V_{CC} = 300\text{ V}$, $R_g = 4.7\ \Omega$, $V_{GE} = 15\text{ V}$, $L = 500\ \mu\text{H}$

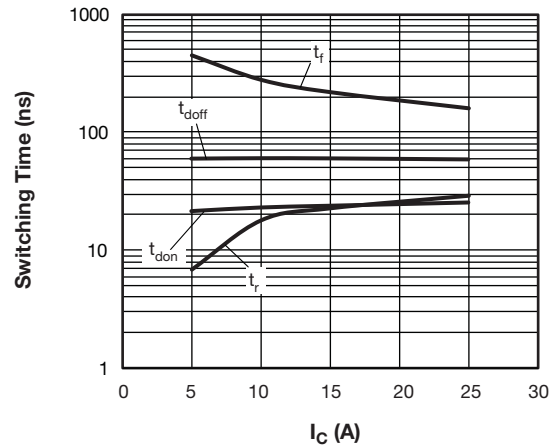

Fig. 10 - Typical PFC IGBT Switching Time vs. I_C (with Freewheeling Clamping Diode)
 $T_J = 125\text{ °C}$, $V_{CC} = 600\text{ V}$, $R_g = 4.7\ \Omega$, $V_{GE} = 15\text{ V}$, $L = 500\ \mu\text{H}$

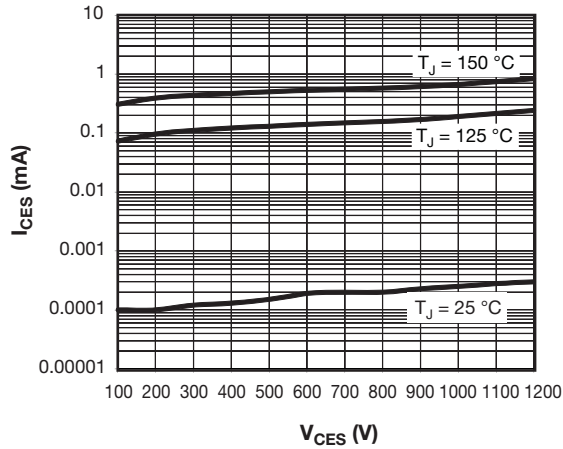

Fig. 8 - Typical Ta1 - Ta2 - Tb1 - Tb2 PFC IGBT Zero Gate Voltage Collector Current

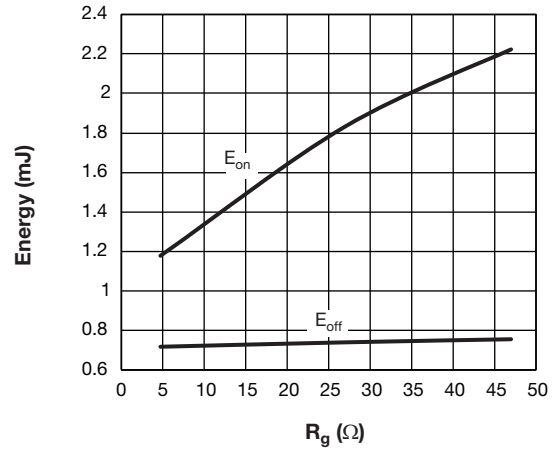

Fig. 11 - Typical PFC IGBT Energy Loss vs. R_g (with Freewheeling Clamping Diode)
 $T_J = 125\text{ °C}$, $V_{CC} = 600\text{ V}$, $I_C = 15\text{ A}$, $V_{GE} = 15\text{ V}$, $L = 500\ \mu\text{H}$

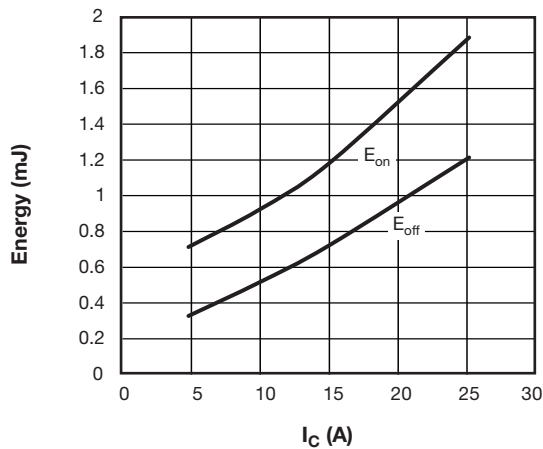

Fig. 9 - Typical PFC IGBT Energy Loss vs. I_C (with Freewheeling Clamping Diode)
 $T_J = 125\text{ °C}$, $V_{CC} = 600\text{ V}$, $R_g = 4.7\ \Omega$, $V_{GE} = 15\text{ V}$, $L = 500\ \mu\text{H}$

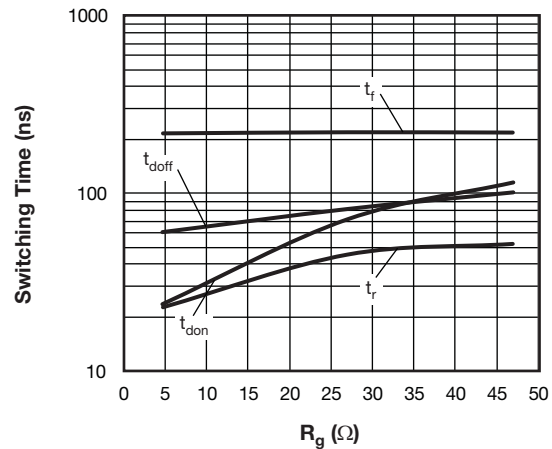

Fig. 12 - Typical PFC IGBT Switching Time vs. R_g (with Freewheeling Clamping Diode)
 $T_J = 125\text{ °C}$, $V_{CC} = 600\text{ V}$, $I_C = 15\text{ A}$, $V_{GE} = 15\text{ V}$, $L = 500\ \mu\text{H}$

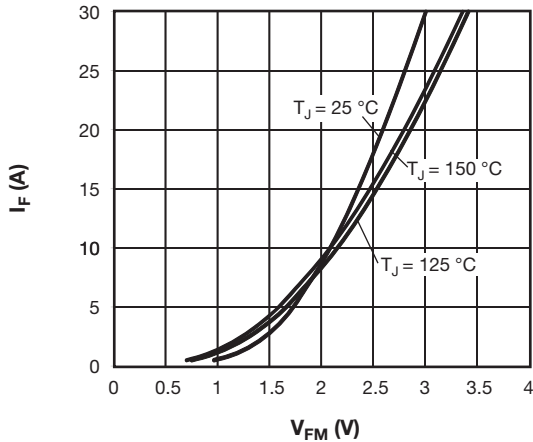

Fig. 13 - Typical Da1 - Da2 - Db1 - Db2 Clamping Diode Forward Characteristics

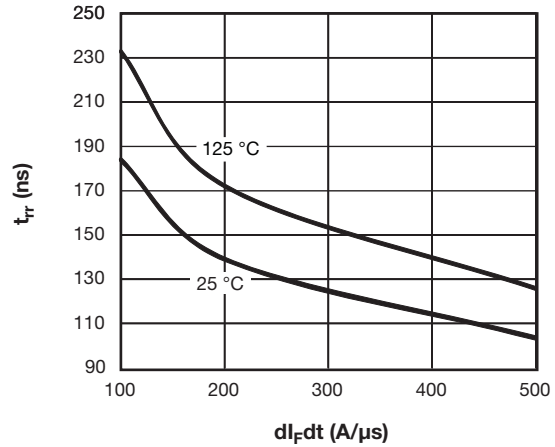

Fig. 16 - Typical Da1 - Da2 - Db1 - Db2 Clamping Diode Reverse Recovery Time vs. di_F/dt , $V_{rr} = 400\text{ V}$, $I_F = 10\text{ A}$

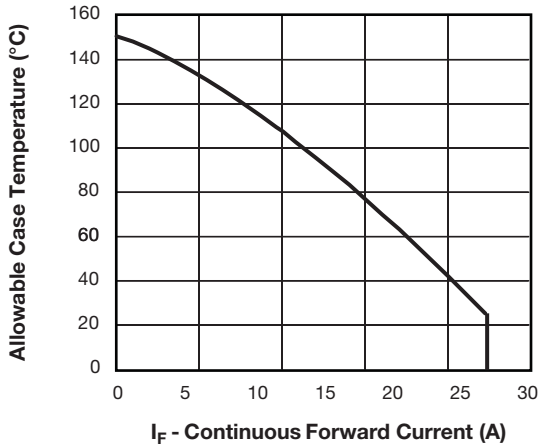

Fig. 14 - Maximum Da1 - Da2 - Db1 - Db2 Clamping Diode Forward Current vs. Case Temperature

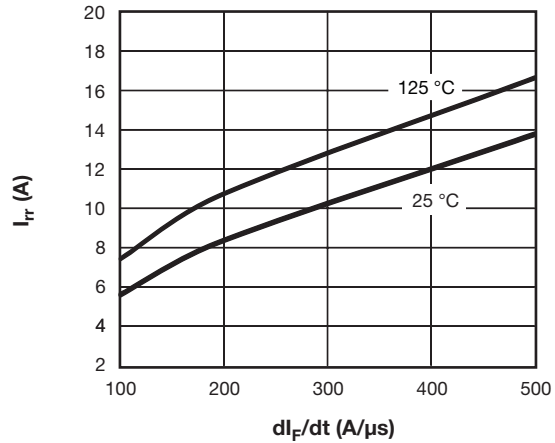

Fig. 17 - Typical Da1 - Da2 - Db1 - Db2 Clamping Diode Reverse Recovery Current vs. di_F/dt , $V_{rr} = 400\text{ V}$, $I_F = 10\text{ A}$

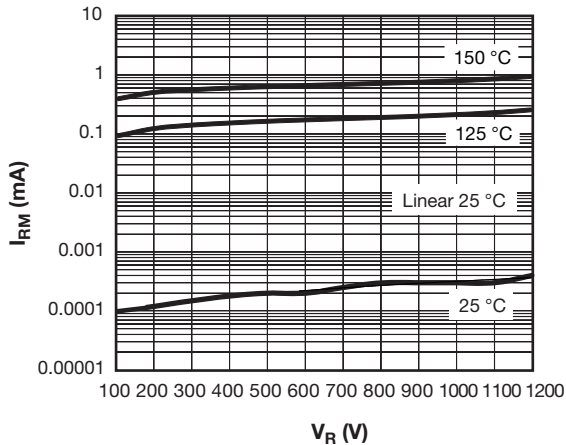

Fig. 15 - Typical Da1 - Da2 - Db1 - Db2 Clamping Diode Reverse Leakage Current

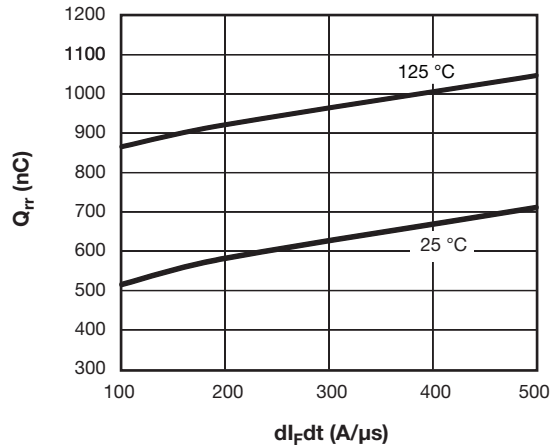

Fig. 18 - Typical Da1 - Da2 - Db1 - Db2 Clamping Diode Reverse Recovery Charge vs. di_F/dt , $V_{rr} = 400\text{ V}$, $I_F = 10\text{ A}$

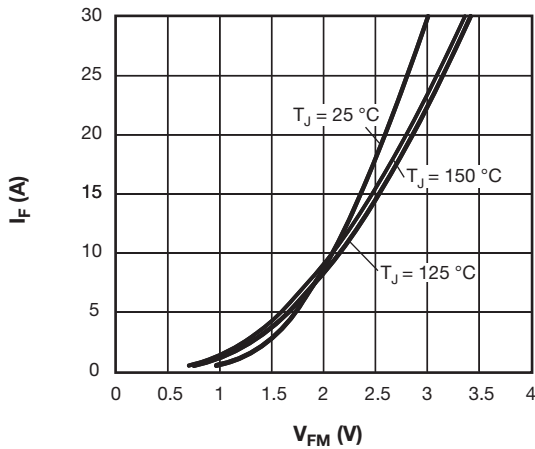

Fig. 19 - Typical DTa1 - DTa2 - DTb1 - DTb2 Antiparallel Diode Forward Characteristics

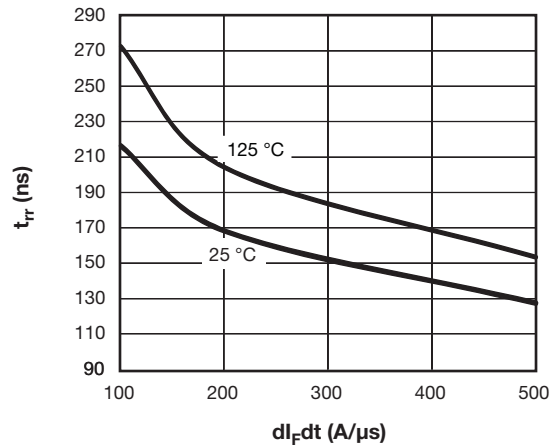

Fig. 21 - Typical DTa1 - DTa2 - DTb1 - DTb2 Antiparallel Diode Reverse Recovery Time vs. dI_F/dt
 $V_{rr} = 400\text{ V}$, $I_F = 20\text{ A}$

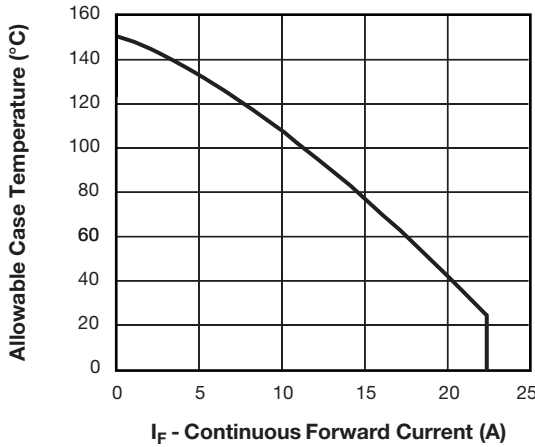

Fig. 20 - Maximum DTa1 - DTa2 - DTb1 - DTb2 Antiparallel Diode Forward Current vs. Case Temperature

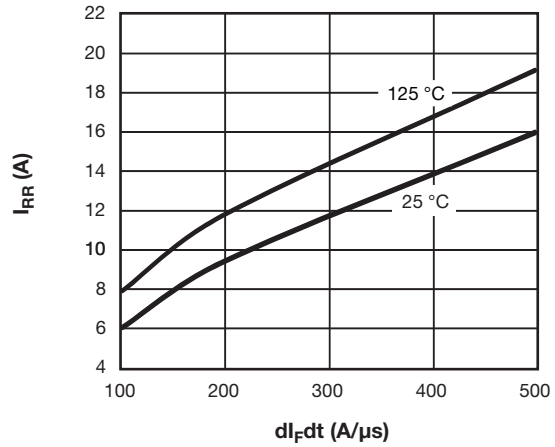

Fig. 22 - Typical DTa1 - DTa2 - DTb1 - DTb2 Antiparallel Diode Reverse Recovery Current vs. dI_F/dt
 $V_{rr} = 400\text{ V}$, $I_F = 10\text{ A}$

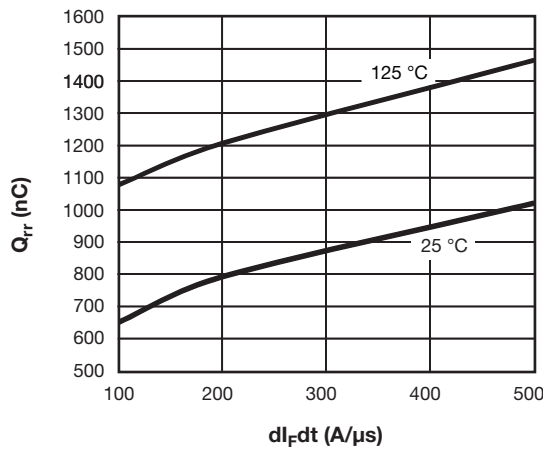

Fig. 23 - Typical DTa1 - DTa2 - DTb1 - DTb2 Antiparallel Diode Reverse Recovery Charge vs. dI_F/dt
 $V_{rr} = 400\text{ V}$, $I_F = 20\text{ A}$

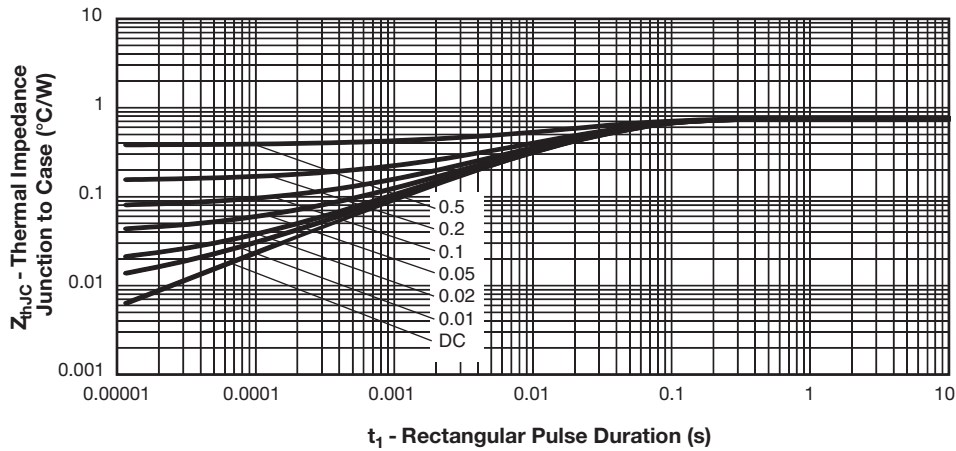

Fig. 24 - Maximum Thermal Impedance Z_{thJC} Characteristics (DbPa - DbpB Bypass Diode)

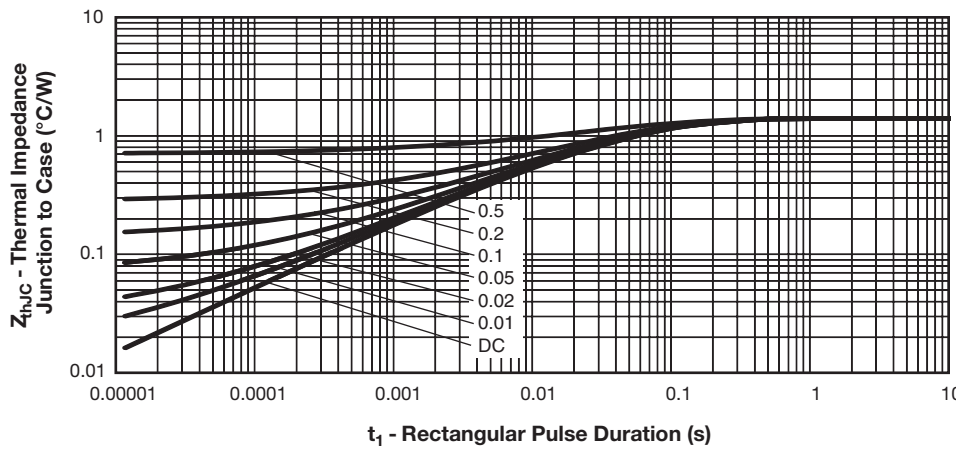

Fig. 25 - Maximum Thermal Impedance Z_{thJC} Characteristics (Ta1 - Ta2 - Tb1 - Tb2 PFC IGBT)

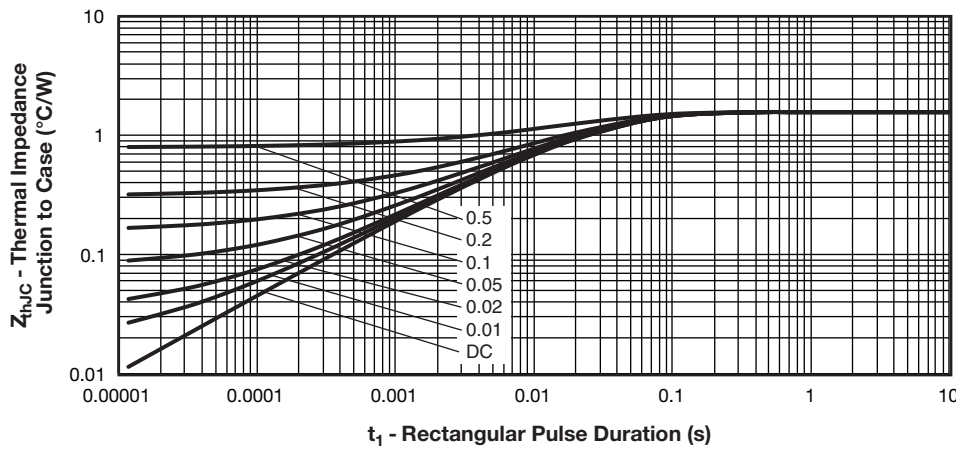

Fig. 26 - Maximum Thermal Impedance Z_{thJC} Characteristics (Da1 - Da2 - Db1 - Db2 Clamping diode)

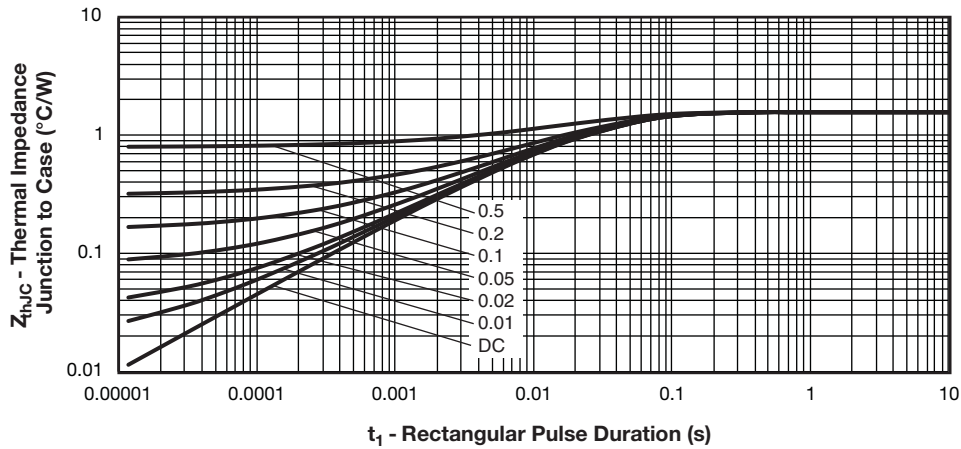

Fig. 27 - Maximum Thermal Impedance Z_{thJC} Characteristics (DTa1 - DTa2 - DTb1 - DTb2 Antiparallel Diode)

ORDERING INFORMATION TABLE

Device code	VS-	ET	L	015	Y	120	H
	①	②	③	④	⑤	⑥	⑦

- 1** - Vishay Semiconductors product
- 2** - Package indicator (ET = EMIPAK-2B)
- 3** - Circuit configuration (L = double interleaved boost converter)
- 4** - Current rating (015 = 15 A)
- 5** - Switch die technology (Y = trench IGBT)
- 6** - Voltage rating (120 = 1200 V)
- 7** - Diode die technology (H = HEXFRED diode)



CIRCUIT CONFIGURATION

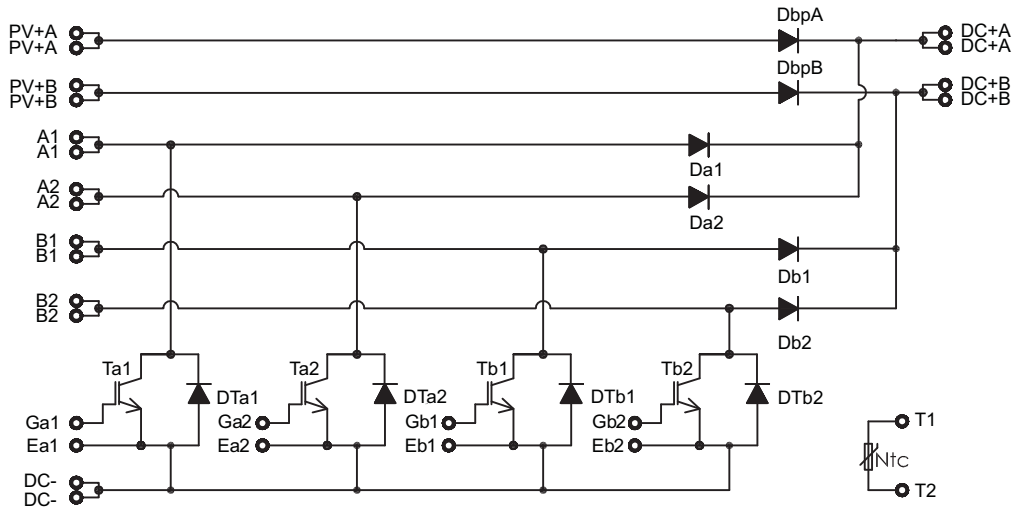

PACKAGE

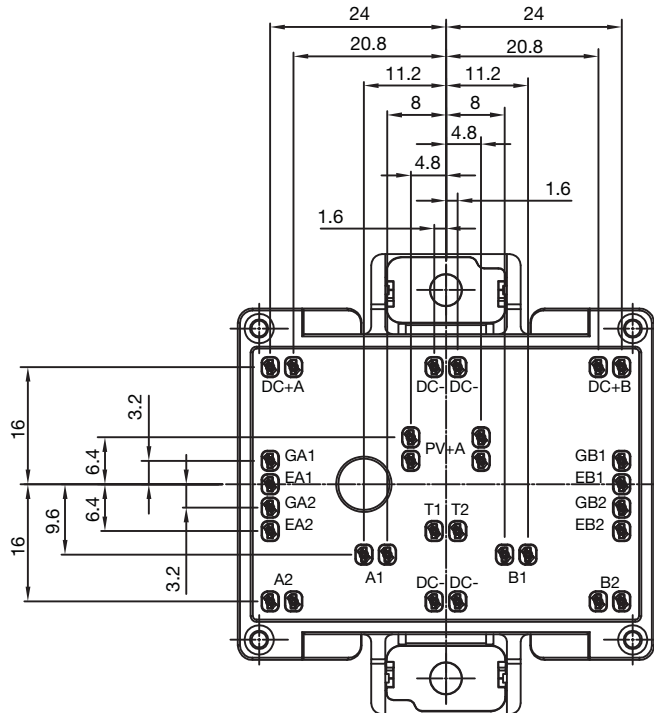

LINKS TO RELATED DOCUMENTS

Dimensions	www.vishay.com/doc?95559
------------	--



EMIPAK-2B PressFit

DIMENSIONS in millimeters

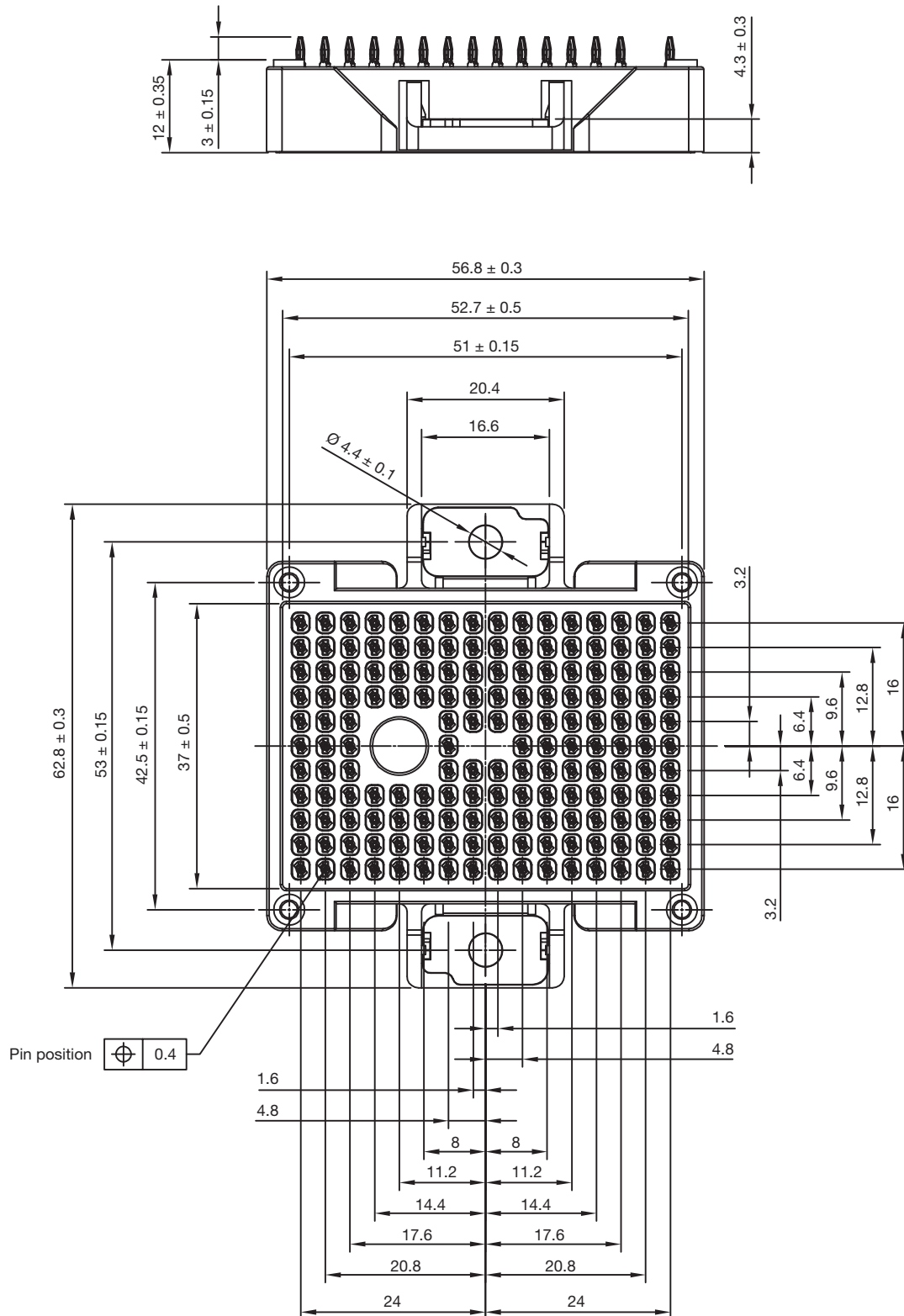



Disclaimer

ALL PRODUCT, PRODUCT SPECIFICATIONS AND DATA ARE SUBJECT TO CHANGE WITHOUT NOTICE TO IMPROVE RELIABILITY, FUNCTION OR DESIGN OR OTHERWISE.

Vishay Intertechnology, Inc., its affiliates, agents, and employees, and all persons acting on its or their behalf (collectively, "Vishay"), disclaim any and all liability for any errors, inaccuracies or incompleteness contained in any datasheet or in any other disclosure relating to any product.

Vishay makes no warranty, representation or guarantee regarding the suitability of the products for any particular purpose or the continuing production of any product. To the maximum extent permitted by applicable law, Vishay disclaims (i) any and all liability arising out of the application or use of any product, (ii) any and all liability, including without limitation special, consequential or incidental damages, and (iii) any and all implied warranties, including warranties of fitness for particular purpose, non-infringement and merchantability.

Statements regarding the suitability of products for certain types of applications are based on Vishay's knowledge of typical requirements that are often placed on Vishay products in generic applications. Such statements are not binding statements about the suitability of products for a particular application. It is the customer's responsibility to validate that a particular product with the properties described in the product specification is suitable for use in a particular application. Parameters provided in datasheets and / or specifications may vary in different applications and performance may vary over time. All operating parameters, including typical parameters, must be validated for each customer application by the customer's technical experts. Product specifications do not expand or otherwise modify Vishay's terms and conditions of purchase, including but not limited to the warranty expressed therein.

Except as expressly indicated in writing, Vishay products are not designed for use in medical, life-saving, or life-sustaining applications or for any other application in which the failure of the Vishay product could result in personal injury or death. Customers using or selling Vishay products not expressly indicated for use in such applications do so at their own risk. Please contact authorized Vishay personnel to obtain written terms and conditions regarding products designed for such applications.

No license, express or implied, by estoppel or otherwise, to any intellectual property rights is granted by this document or by any conduct of Vishay. Product names and markings noted herein may be trademarks of their respective owners.

单击下面可查看定价，库存，交付和生命周期等信息

[>>Vishay\(威世\)](#)