

# IR Sensor Module for Reflective Sensor, Light Barrier, and Fast Proximity Applications

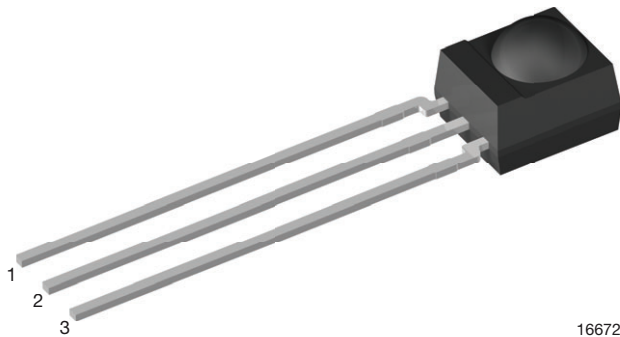

16672

## DESIGN SUPPORT TOOLS AVAILABLE



## MECHANICAL DATA

### Pinning:

 1 = OUT, 2 = GND, 3 =  $V_S$ 

## APPLICATIONS

- Reflective sensors for hand dryers, towel or soap dispensers, water faucets, toilet flush
- Vending machine fall detection
- Security and pet gates
- Person or object vicinity activation
- Fast proximity sensors for toys, robotics, drones, and other consumer and industrial uses

## FEATURES

- Up to 2 m for presence and proximity sensing
- Uses modulated bursts of infrared light
- PIN diode and sensor IC in one package
- Low supply current
- Shielding against EMI
- Visible light is suppressed by IR filter
- Insensitive to supply voltage ripple and noise
- Supply voltage: 2.5 V to 5.5 V
- Material categorization: for definitions of compliance please see [www.vishay.com/doc?99912](http://www.vishay.com/doc?99912)



## DESCRIPTION

The TSSP40.. series are compact infrared detector modules for presence and fast proximity sensing applications. They provide an active low output in response to infrared bursts at 940 nm. The frequency of the burst should correspond to the carrier frequency shown in the parts table.

This component has not been qualified according to automotive specifications.

PARTS TABLE		
Carrier frequency	38 kHz	TSSP4038
	56 kHz	TSSP4056
Package	Mold	
Pinning	1 = OUT, 2 = GND, 3 = $V_S$	
Dimensions (mm)	6.0 W x 6.95 H x 5.6 D	
Mounting	Leaded	
Application	Presence sensors, fast proximity sensors	

## BLOCK DIAGRAM

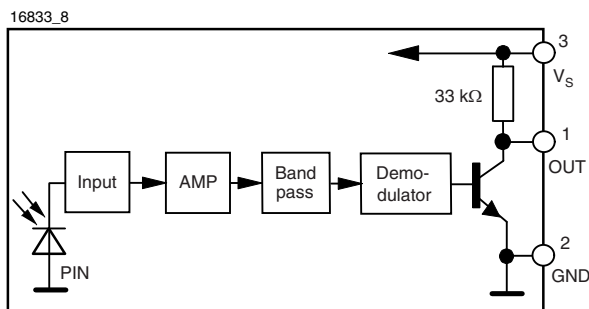

## PRESENCE SENSING

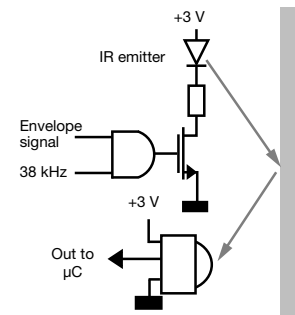



ABSOLUTE MAXIMUM RATINGS				
PARAMETER	TEST CONDITION	SYMBOL	VALUE	UNIT
Supply voltage (pin 3)		$V_S$	-0.3 to +6.0	V
Supply current (pin 3)		$I_S$	5	mA
Output voltage (pin 1)		$V_O$	-0.3 to 5.5	V
Voltage at output to supply		$V_S - V_O$	-0.3 to ( $V_S + 0.3$ )	V
Output current (pin 1)		$I_O$	5	mA
Junction temperature		$T_j$	100	°C
Storage temperature range		$T_{stg}$	-25 to +85	°C
Operating temperature range		$T_{amb}$	-25 to +85	°C
Power consumption	$T_{amb} \leq 85\text{ °C}$	$P_{tot}$	10	mW

**Note**

- Stresses beyond those listed under “Absolute Maximum Ratings” may cause permanent damage to the device. This is a stress rating only and functional operation of the device at these or any other conditions beyond those indicated in the operational sections of this specification is not implied. Exposure to absolute maximum rating conditions for extended periods may affect the device reliability

ELECTRICAL AND OPTICAL CHARACTERISTICS ( $T_{amb} = 25\text{ °C}$ , unless otherwise specified)						
PARAMETER	TEST CONDITION	SYMBOL	MIN.	TYP.	MAX.	UNIT
Supply current (pin 3)	$E_v = 0, V_S = 5\text{ V}$	$I_{SD}$	0.55	0.7	0.9	mA
	$E_v = 40\text{ klx}$ , sunlight	$I_{SH}$	-	0.8	-	mA
Supply voltage		$V_S$	2.5	-	5.5	V
Transmission distance	$E_v = 0$ , test signal see Fig. 1, IR diode TSAL6200, $I_F = 50\text{ mA}$	$d$	-	12	-	m
Output voltage low (pin 1)	$I_{OSL} = 0.5\text{ mA}$ , $E_e = 2\text{ mW/m}^2$ , test signal see Fig. 1	$V_{OSL}$	-	-	100	mV
Minimum irradiance	Pulse width tolerance: $t_{pi} - 5/f_0 < t_{po} < t_{pi} + 6/f_0$ , test signal see Fig. 1	$E_e\text{ min.}$	-	0.4	0.7	$\text{mW/m}^2$
Maximum irradiance	$t_{pi} - 5/f_0 < t_{po} < t_{pi} + 6/f_0$ , test signal see Fig. 1	$E_e\text{ max.}$	50	-	-	$\text{W/m}^2$
Directivity	Angle of half transmission distance	$\phi_{1/2}$	-	$\pm 45$	-	deg

**TYPICAL CHARACTERISTICS** ( $T_{amb} = 25\text{ }^{\circ}\text{C}$ , unless otherwise specified)

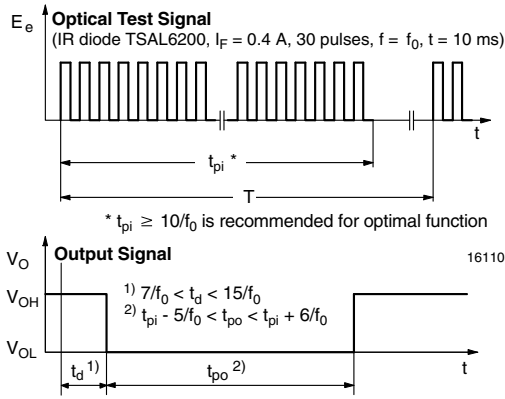

Fig. 1 - Output Active Low

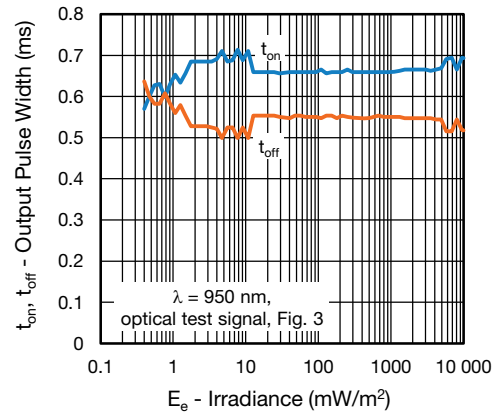

Fig. 4 - Output Pulse Diagram

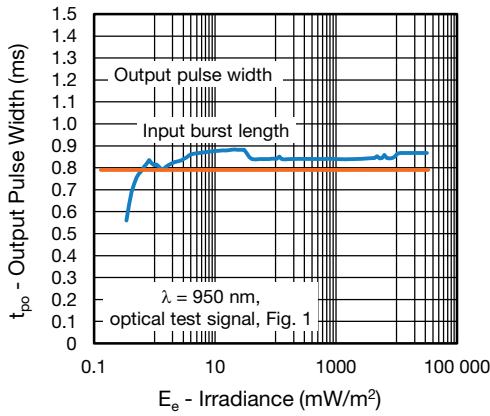

Fig. 2 - Pulse Length and Sensitivity in Dark Ambient

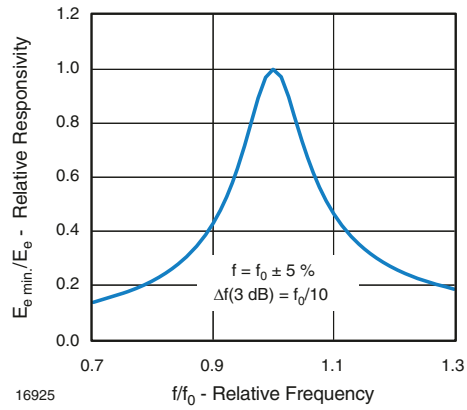

Fig. 5 - Frequency Dependence of Responsivity

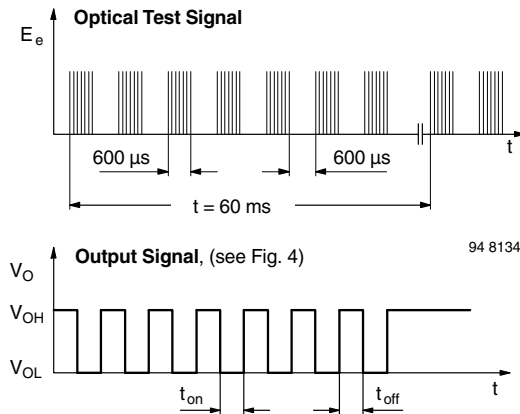

Fig. 3 - Output Function

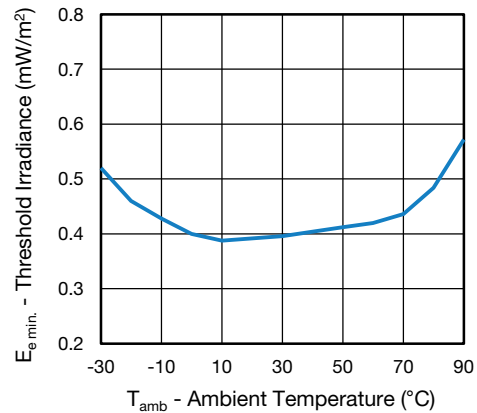
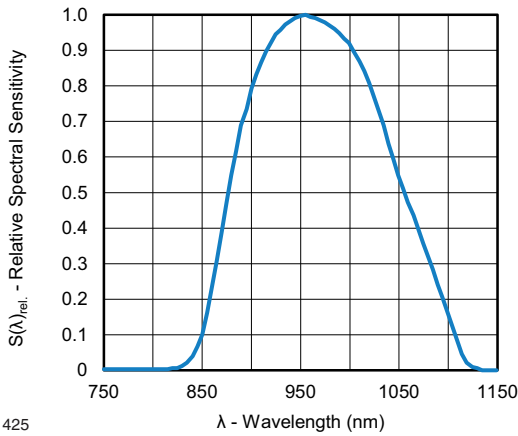

Fig. 6 - Sensitivity vs. Ambient Temperature



21425

Fig. 7 - Relative Spectral Sensitivity vs. Wavelength

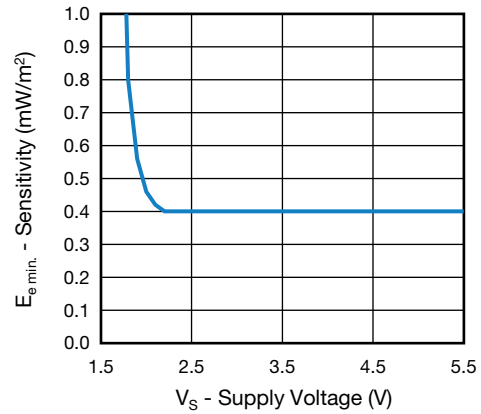
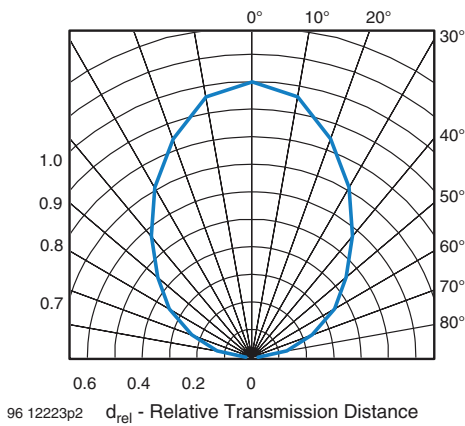

Fig. 9 - Sensitivity vs. Supply Voltage



96 12223p2

Fig. 8 - Directivity

The typical application of these devices is a reflective or beam break sensor with active low “detect” or “no detect” information contained in its output. The TSSP4056 is also suitable for fast (~ 5 ms) proximity sensor applications for ranges between 10 cm and 2 m. Please see application note “Vishay’s TSSP4056 Sensor for Fast Proximity Sensing” ([www.vishay.com/doc?82741](http://www.vishay.com/doc?82741)).

Example for a sensor hardware:

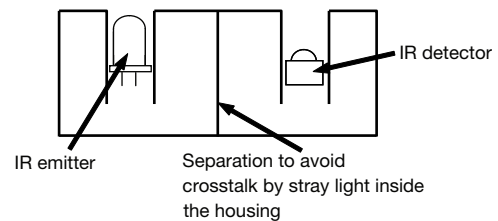

There should be no common window in front of the emitter and detector in order to avoid crosstalk via guided light through the window.



PACKAGE DIMENSIONS in millimeters

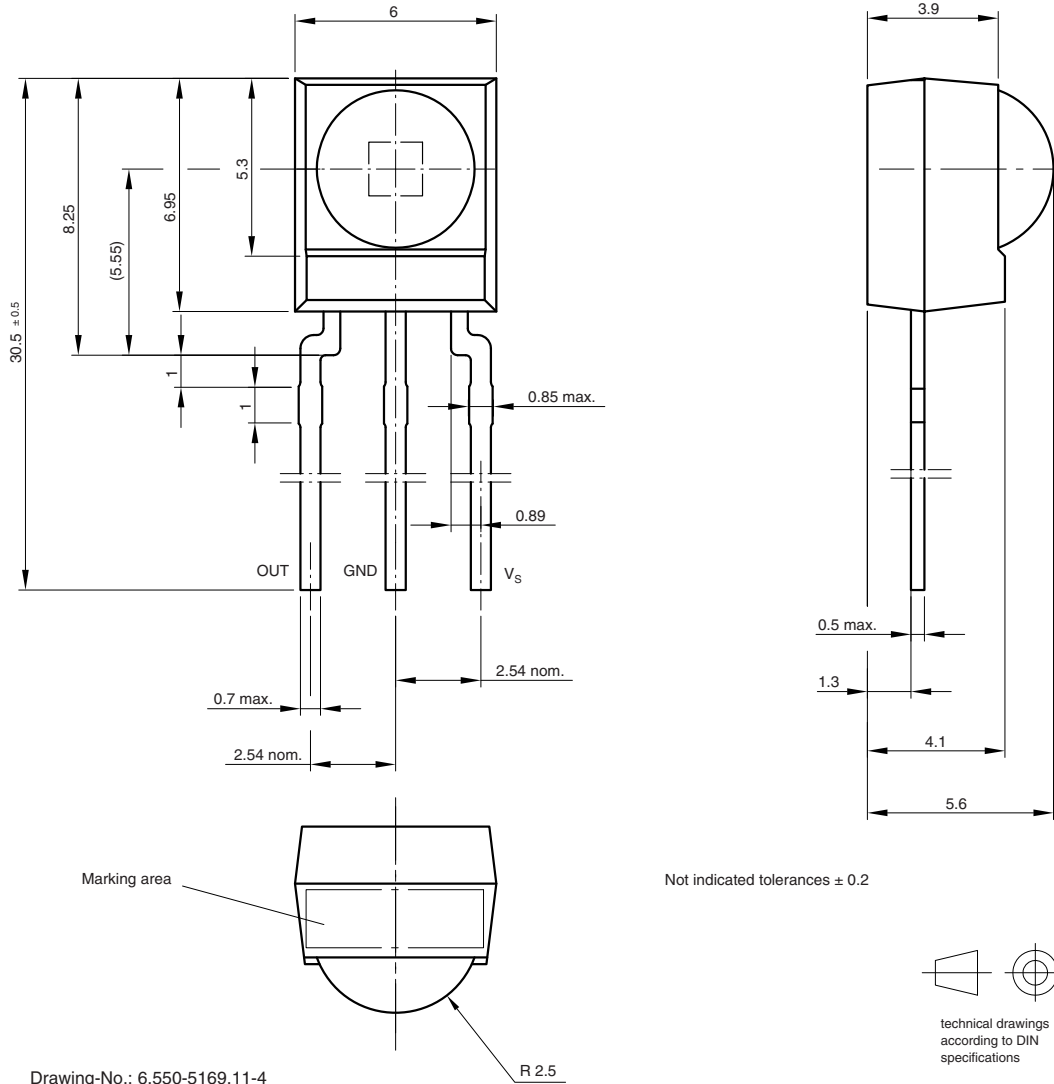

Drawing-No.: 6.550-5169.11-4  
 Issue: 13; 17.12.08  
 16003



## Disclaimer

ALL PRODUCT, PRODUCT SPECIFICATIONS AND DATA ARE SUBJECT TO CHANGE WITHOUT NOTICE TO IMPROVE RELIABILITY, FUNCTION OR DESIGN OR OTHERWISE.

Vishay Intertechnology, Inc., its affiliates, agents, and employees, and all persons acting on its or their behalf (collectively, "Vishay"), disclaim any and all liability for any errors, inaccuracies or incompleteness contained in any datasheet or in any other disclosure relating to any product.

Vishay makes no warranty, representation or guarantee regarding the suitability of the products for any particular purpose or the continuing production of any product. To the maximum extent permitted by applicable law, Vishay disclaims (i) any and all liability arising out of the application or use of any product, (ii) any and all liability, including without limitation special, consequential or incidental damages, and (iii) any and all implied warranties, including warranties of fitness for particular purpose, non-infringement and merchantability.

Statements regarding the suitability of products for certain types of applications are based on Vishay's knowledge of typical requirements that are often placed on Vishay products in generic applications. Such statements are not binding statements about the suitability of products for a particular application. It is the customer's responsibility to validate that a particular product with the properties described in the product specification is suitable for use in a particular application. Parameters provided in datasheets and / or specifications may vary in different applications and performance may vary over time. All operating parameters, including typical parameters, must be validated for each customer application by the customer's technical experts. Product specifications do not expand or otherwise modify Vishay's terms and conditions of purchase, including but not limited to the warranty expressed therein.

Except as expressly indicated in writing, Vishay products are not designed for use in medical, life-saving, or life-sustaining applications or for any other application in which the failure of the Vishay product could result in personal injury or death. Customers using or selling Vishay products not expressly indicated for use in such applications do so at their own risk. Please contact authorized Vishay personnel to obtain written terms and conditions regarding products designed for such applications.

No license, express or implied, by estoppel or otherwise, to any intellectual property rights is granted by this document or by any conduct of Vishay. Product names and markings noted herein may be trademarks of their respective owners.

单击下面可查看定价，库存，交付和生命周期等信息

[>>Vishay\(威世\)](#)