

Dual P-Channel 8 V (D-S) MOSFET

PRODUCT SUMMARY			
V _{DS} (V)	R _{DS(on)} (Ω)	I _D (A)	Q _g (Typ.)
- 8	0.070 at V _{GS} = - 4.5 V	4 ^a	5 nC
	0.086 at V _{GS} = - 2.5 V	4 ^a	
	0.145 at V _{GS} = - 1.8 V	3.6	

FEATURES

- Halogen-free According to IEC 61249-2-21 Definition
- TrenchFET[®] Power MOSFET
- Low Thermal Resistance
- 40 % Smaller Footprint than TSOP-6
- Compliant to RoHS Directive 2002/95/EC



RoHS
COMPLIANT
HALOGEN
FREE
Available

APPLICATIONS

- Load Switch or Battery Switch for Portable Devices

1206-8 ChipFET[®] (Dual)

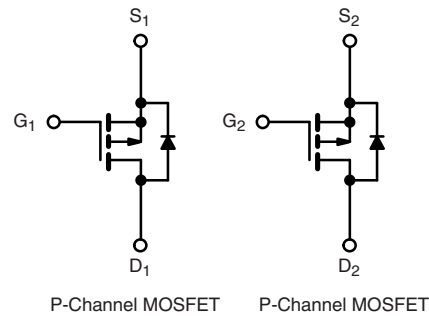
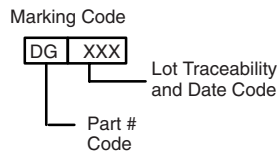
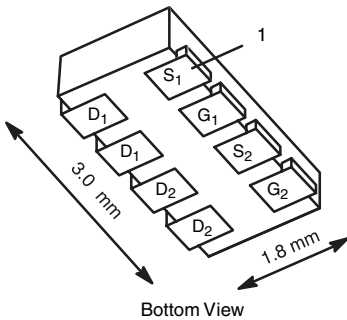

Ordering Information: Si5915BDC-T1-E3 (Lead (Pb)-free)
Si5915BDC-T1-GE3 (Lead (Pb)-free and Halogen-free)

ABSOLUTE MAXIMUM RATINGS T _A = 25 °C, unless otherwise noted			
Parameter	Symbol	Limit	Unit
Drain-Source Voltage	V _{DS}	- 8	V
Gate-Source Voltage	V _{GS}	± 8	
Continuous Drain Current (T _J = 150 °C)	I _D	T _C = 25 °C	- 4 ^a
		T _C = 70 °C	- 4 ^a
		T _A = 25 °C	- 4 ^{a, b, c}
		T _A = 70 °C	- 3.2 ^{b, c}
Pulsed Drain Current	I _{DM}	- 10	A
Continuous Source-Drain Diode Current	I _S	T _C = 25 °C	
		T _A = 25 °C	- 1.9 ^{b, c}
Maximum Power Dissipation	P _D	T _C = 25 °C	3.1
		T _C = 70 °C	2
		T _A = 25 °C	1.7 ^{b, c}
		T _A = 70 °C	1.1 ^{b, c}
Operating Junction and Storage Temperature Range	T _J , T _{stg}	- 55 to 150	°C
Soldering Recommendations (Peak Temperature) ^{d, e}		260	

THERMAL RESISTANCE RATINGS					
Parameter		Symbol	Typical	Maximum	Unit
Maximum Junction-to-Ambient ^{b, f}	t ≤ 5 s	R _{thJA}	62	74	°C/W
Maximum Junction-to-Foot (Drain)	Steady State	R _{thJF}	33	40	

Notes:

- Package limited.
- Surface mounted on 1" x 1" FR4 board.
- t = 5 s.
- See Solder Profile (www.vishay.com/ppg?73257). The 1206-8 ChipFET is a leadless package. The end of the lead terminal is exposed copper (not plated) as a result of the singulation process in manufacturing. A solder fillet at the exposed copper tip cannot be guaranteed and is not required to ensure adequate bottom side solder interconnection.
- Rework conditions: manual soldering with a soldering iron is not recommended for leadless components.
- Maximum under steady state conditions is 120 °C/W.

SPECIFICATIONS $T_J = 25\text{ }^\circ\text{C}$, unless otherwise noted						
Parameter	Symbol	Test Conditions	Min.	Typ.	Max.	Unit
Static						
Drain-Source Breakdown Voltage	V_{DS}	$V_{GS} = 0\text{ V}, I_D = -250\text{ }\mu\text{A}$	- 8			V
V_{DS} Temperature Coefficient	$\Delta V_{DS}/T_J$	$I_D = -250\text{ }\mu\text{A}$		- 8.3		mV/ $^\circ\text{C}$
$V_{GS(th)}$ Temperature Coefficient	$\Delta V_{GS(th)}/T_J$		2.1			
Gate-Source Threshold Voltage	$V_{GS(th)}$	$V_{DS} = V_{GS}, I_D = -250\text{ }\mu\text{A}$	- 0.45		- 1.0	V
Gate-Source Leakage	I_{GSS}	$V_{DS} = 0\text{ V}, V_{GS} = \pm 8\text{ V}$			± 100	nA
Zero Gate Voltage Drain Current	I_{DSS}	$V_{DS} = -8\text{ V}, V_{GS} = 0\text{ V}$			- 1	μA
		$V_{DS} = -8\text{ V}, V_{GS} = 0\text{ V}, T_J = 85\text{ }^\circ\text{C}$			- 10	
On-State Drain Current ^a	$I_{D(on)}$	$V_{DS} \leq 4\text{ V}, V_{GS} = -4.5\text{ V}$	- 10			A
Drain-Source On-State Resistance ^a	$R_{DS(on)}$	$V_{GS} = -4.5\text{ V}, I_D = -3.3\text{ A}$		0.058	0.070	Ω
		$V_{GS} = -2.5\text{ V}, I_D = -2.7\text{ A}$		0.086	0.104	
		$V_{GS} = -1.8\text{ V}, I_D = -0.7\text{ A}$		0.120	0.145	
Forward Transconductance	g_{fs}	$V_{DS} = -4\text{ V}, I_D = -3.3\text{ A}$		9		ms
Dynamic^b						
Input Capacitance	C_{iss}	$V_{DS} = -4\text{ V}, V_{GS} = 0\text{ V}, f = 1\text{ MHz}$		420		pF
Output Capacitance	C_{oss}		160			
Reverse Transfer Capacitance	C_{rss}		100			
Total Gate Charge	Q_g	$V_{DS} = -4\text{ V}, V_{GS} = -8\text{ V}, I_D = -4.1\text{ A}$		9	14	nC
				5	7.5	
Gate-Source Charge	Q_{gs}	$V_{DS} = -4\text{ V}, V_{GS} = -4.5\text{ V}, I_D = -4.1\text{ A}$		0.7		
Gate-Drain Charge	Q_{gd}		0.7			
Gate Resistance	R_g	$f = 1\text{ MHz}$		7		Ω
Turn-On Delay Time	$t_{d(on)}$	$V_{DD} = -4\text{ V}, R_L = 1.2\text{ }\Omega$ $I_D \cong -3.3\text{ A}, V_{GEN} = -4.5\text{ V}, R_g = 1\text{ }\Omega$		12	20	ns
Rise Time	t_r		30	45		
Turn-Off Delay Time	$t_{d(off)}$		20	30		
Fall Time	t_f		7	15		
Turn-On Delay Time	$t_{d(on)}$	$V_{DD} = -4\text{ V}, R_L = 1.2\text{ }\Omega$ $I_D \cong -3.3\text{ A}, V_{GEN} = -8\text{ V}, R_g = 1\text{ }\Omega$		5	10	
Rise Time	t_r		12	20		
Turn-Off Delay Time	$t_{d(off)}$		20	30		
Fall Time	t_f		10	15		
Drain-Source Body Diode Characteristics						
Continuous Source-Drain Diode Current	I_S	$T_C = 25\text{ }^\circ\text{C}$			- 4	A
Pulse Diode Forward Current	I_{SM}				- 10	
Body Diode Voltage	V_{SD}	$I_S = -3.3\text{ A}, V_{GS} = 0\text{ V}$		- 0.8	- 1.2	V
Body Diode Reverse Recovery Time	t_{rr}	$I_F = -3.3\text{ A}, di/dt = 100\text{ A}/\mu\text{s},$ $T_J = 25\text{ }^\circ\text{C}$		60	90	nC
Body Diode Reverse Recovery Charge	Q_{rr}		39	60		
Reverse Recovery Fall Time	t_a		20			
Reverse Recovery Rise Time	t_b		40			

Notes:

- a. Pulse test; pulse width $\leq 300\text{ }\mu\text{s}$, duty cycle $\leq 2\%$.
b. Guaranteed by design, not subject to production testing.

Stresses beyond those listed under "Absolute Maximum Ratings" may cause permanent damage to the device. These are stress ratings only, and functional operation of the device at these or any other conditions beyond those indicated in the operational sections of the specifications is not implied. Exposure to absolute maximum rating conditions for extended periods may affect device reliability.

TYPICAL CHARACTERISTICS 25 °C, unless otherwise noted

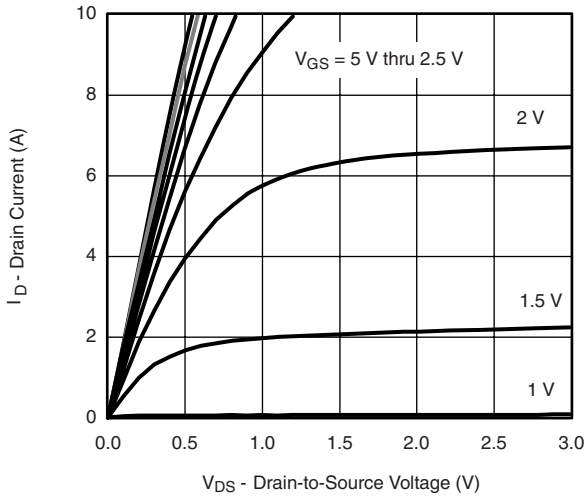

Output Characteristics

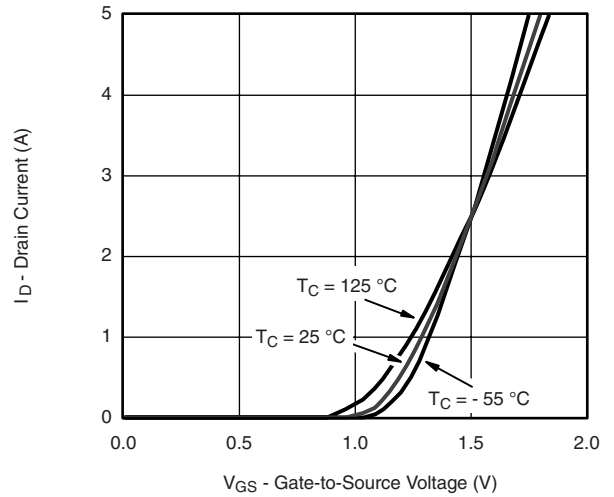

Transfer Characteristics Curves vs. Temperature

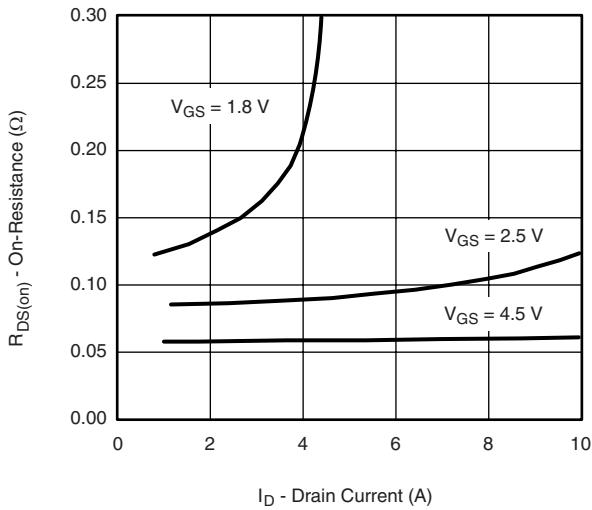

On-Resistance vs. Drain Current

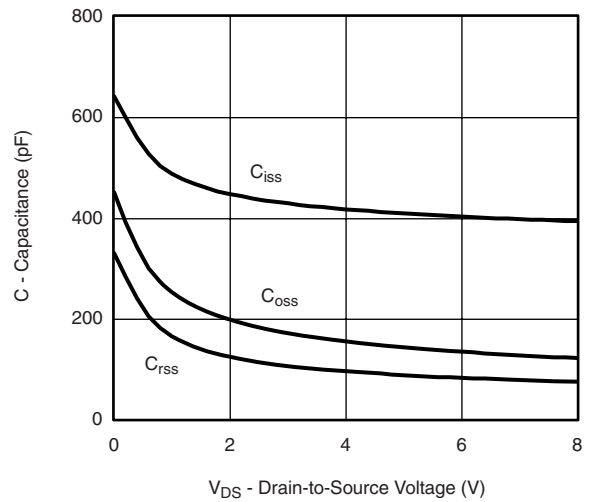

Capacitance

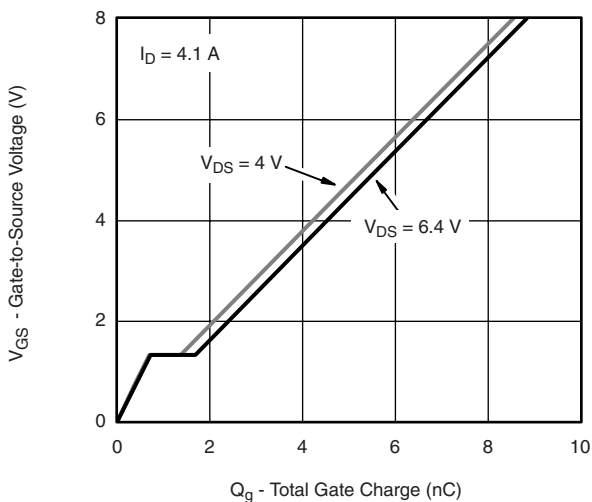

Q_g - Gate Charge

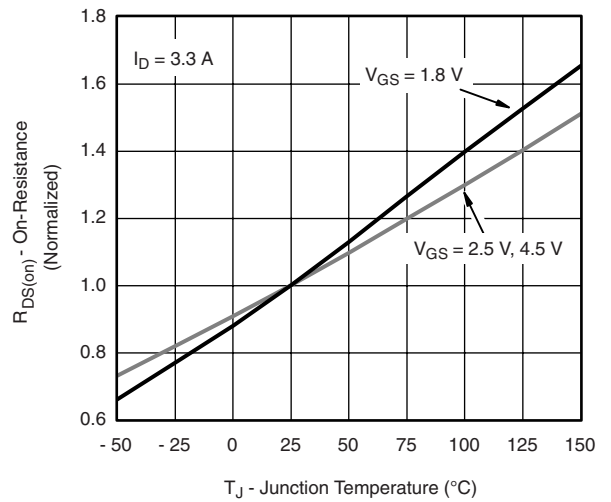

On-Resistance vs. Junction Temperature

TYPICAL CHARACTERISTICS 25 °C, unless otherwise noted

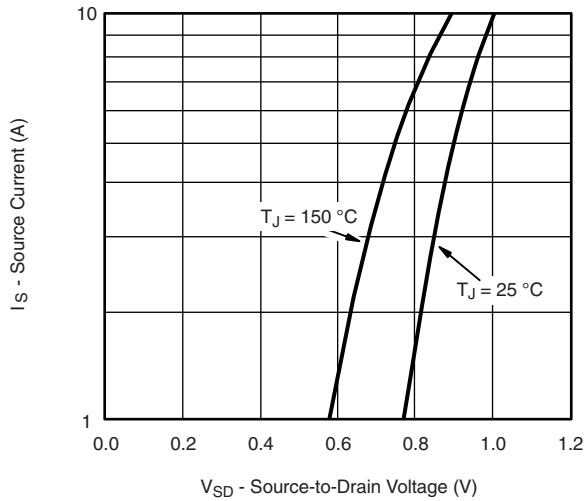

Source-Drain Diode Forward Voltage

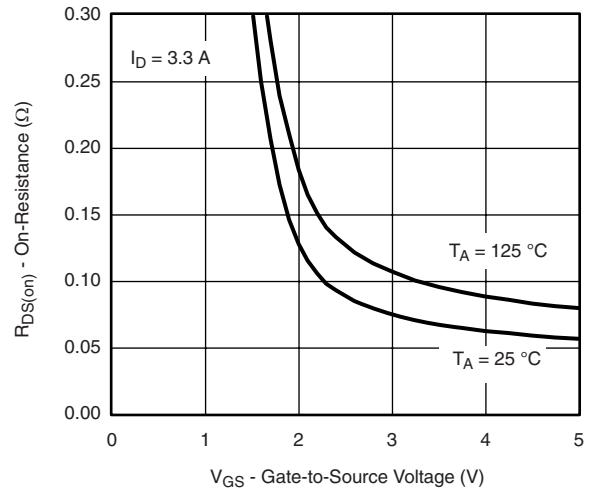

On-Resistance vs. Gate-to-Source Voltage

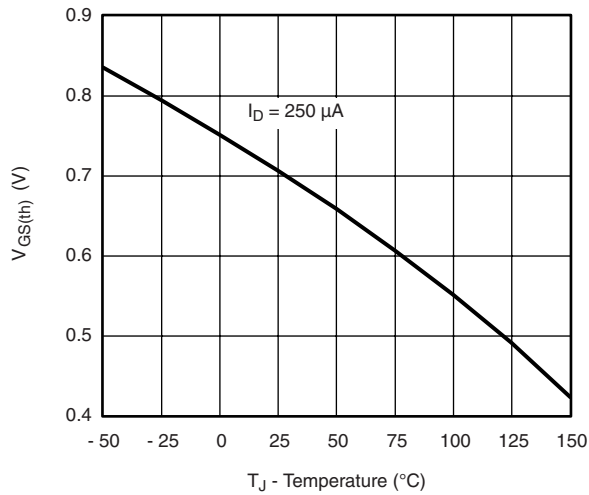

Threshold Voltage

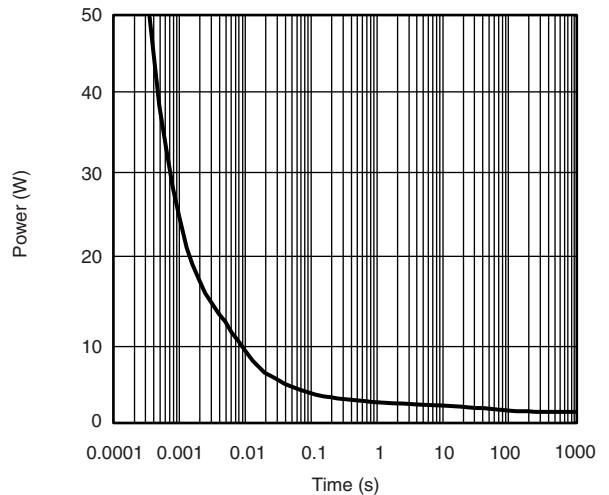

Single Pulse Power

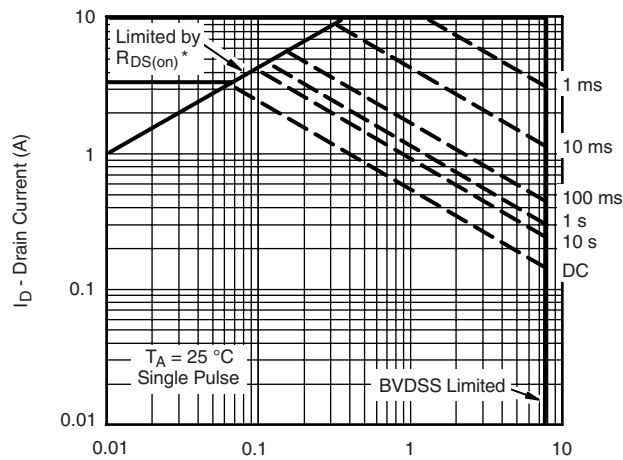

V_{DS} - Drain-to-Source Voltage (V)

* $V_{GS} >$ minimum V_{GS} at which $R_{DS(on)}$ is specified

Safe Operating Area

TYPICAL CHARACTERISTICS 25 °C, unless otherwise noted

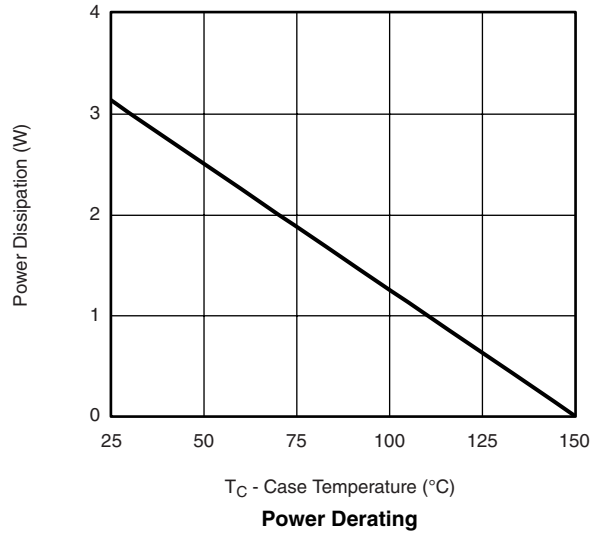
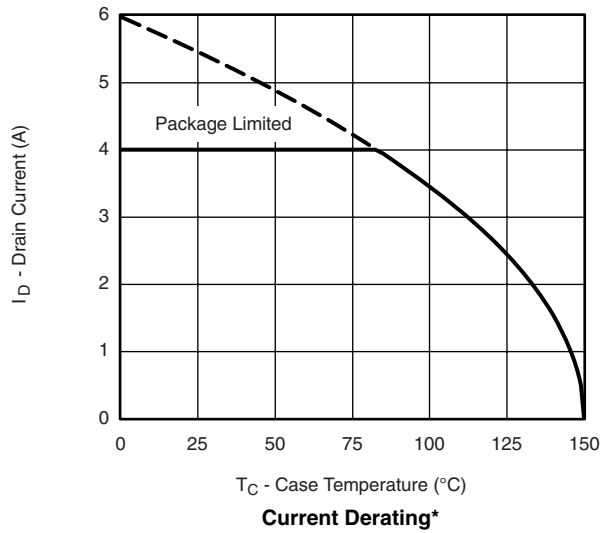

* The power dissipation P_D is based on $T_{J(max)} = 150\text{ °C}$, using junction-to-case thermal resistance, and is more useful in settling the upper dissipation limit for cases where additional heatsinking is used. It is used to determine the current rating, when this rating falls below the package limit.

TYPICAL CHARACTERISTICS 25 °C, unless otherwise noted

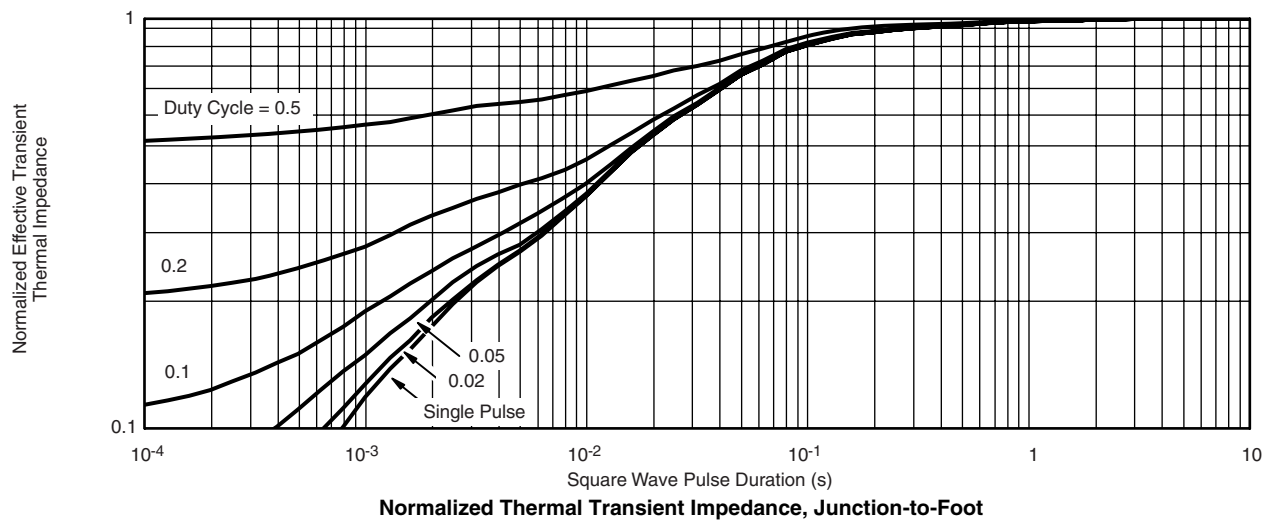
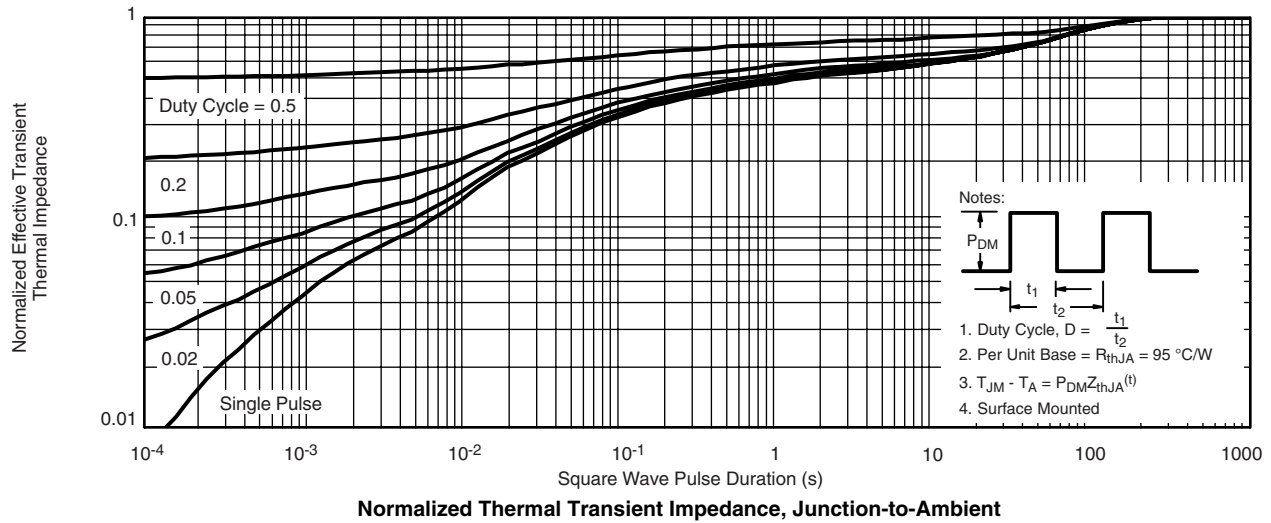

Vishay Siliconix maintains worldwide manufacturing capability. Products may be manufactured at one of several qualified locations. Reliability data for Silicon Technology and Package Reliability represent a composite of all qualified locations. For related documents such as package/tape drawings, part marking, and reliability data, see www.vishay.com/ppg?70484.



Disclaimer

All product specifications and data are subject to change without notice.

Vishay Intertechnology, Inc., its affiliates, agents, and employees, and all persons acting on its or their behalf (collectively, "Vishay"), disclaim any and all liability for any errors, inaccuracies or incompleteness contained herein or in any other disclosure relating to any product.

Vishay disclaims any and all liability arising out of the use or application of any product described herein or of any information provided herein to the maximum extent permitted by law. The product specifications do not expand or otherwise modify Vishay's terms and conditions of purchase, including but not limited to the warranty expressed therein, which apply to these products.

No license, express or implied, by estoppel or otherwise, to any intellectual property rights is granted by this document or by any conduct of Vishay.

The products shown herein are not designed for use in medical, life-saving, or life-sustaining applications unless otherwise expressly indicated. Customers using or selling Vishay products not expressly indicated for use in such applications do so entirely at their own risk and agree to fully indemnify Vishay for any damages arising or resulting from such use or sale. Please contact authorized Vishay personnel to obtain written terms and conditions regarding products designed for such applications.

Product names and markings noted herein may be trademarks of their respective owners.

单击下面可查看定价，库存，交付和生命周期等信息

[>>Vishay\(威世\)](#)