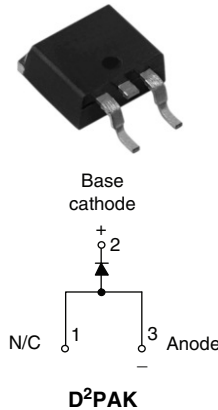

HEXFRED® Ultrafast Soft Recovery Diode, 6 A

FEATURES

- Ultrafast recovery
- Ultrasoft recovery
- Very low I_{RRM}
- Very low Q_{rr}
- Specified at operating conditions
- Designed and qualified for industrial level

BENEFITS

- Reduced RFI and EMI
- Reduced power loss in diode and switching transistor
- Higher frequency operation
- Reduced snubbing
- Reduced parts count

DESCRIPTION

HFA06TB120S is a state of the art ultrafast recovery diode. Employing the latest in epitaxial construction and advanced processing techniques it features a superb combination of characteristics which result in performance which is unsurpassed by any rectifier previously available. With basic ratings of 1200 V and 6 A continuous current, the HFA06TB120S is especially well suited for use as the companion diode for IGBTs and MOSFETs. In addition to ultrafast recovery time, the HEXFRED® product line features extremely low values of peak recovery current (I_{RRM}) and does not exhibit any tendency to “snap-off” during the t_b portion of recovery. The HEXFRED features combine to offer designers a rectifier with lower noise and significantly lower switching losses in both the diode and the switching transistor. These HEXFRED advantages can help to significantly reduce snubbing, component count and heatsink sizes. The HEXFRED HFA06TB120S is ideally suited for applications in power supplies and power conversion systems (such as inverters), motor drives, and many other similar applications where high speed, high efficiency is needed.

PRODUCT SUMMARY

V_R	1200 V
V_F at 6 A at 25 °C	3.0 V
$I_{F(AV)}$	6 A
t_{rr} (typical)	26 ns
T_J (maximum)	150 °C
Q_{rr} (typical)	116 nC
$di_{(rec)M}/dt$ (typical) at 125 °C	100 A/ μ s
I_{RRM} (typical)	4.4 A

ABSOLUTE MAXIMUM RATINGS

PARAMETER	SYMBOL	TEST CONDITIONS	VALUES	UNITS
Cathode to anode voltage	V_R		1200	V
Maximum continuous forward current	I_F	$T_C = 100\text{ °C}$	6	A
Single pulse forward current	I_{FSM}		80	
Maximum repetitive forward current	I_{FRM}		24	
Maximum power dissipation	P_D	$T_C = 25\text{ °C}$	62.5	W
		$T_C = 100\text{ °C}$	25	
Operating junction and storage temperature range	T_J, T_{Stg}		- 55 to + 150	°C

ELECTRICAL SPECIFICATIONS (T _J = 25 °C unless otherwise specified)						
PARAMETER	SYMBOL	TEST CONDITIONS	MIN.	TYP.	MAX.	UNITS
Cathode to anode breakdown voltage	V _{BR}	I _R = 100 μA	1200	-	-	V
Maximum forward voltage	V _{FM}	I _F = 6.0 A	-	2.7	3.0	
		I _F = 12 A	-	3.5	3.9	
		I _F = 6.0 A, T _J = 125 °C	-	2.4	2.8	
Maximum reverse leakage current	I _{RM}	V _R = V _R rated	-	0.26	5.0	μA
		T _J = 125 °C, V _R = 0.8 x V _R rated	-	110	500	
Junction capacitance	C _T	V _R = 200 V	-	9.0	14	pF
Series inductance	L _S	Measured lead to lead 5 mm from package body	-	8.0	-	nH

DYNAMIC RECOVERY CHARACTERISTICS (T _J = 25 °C unless otherwise specified)						
PARAMETER	SYMBOL	TEST CONDITIONS	MIN.	TYP.	MAX.	UNITS
Reverse recovery time	t _{rr}	I _F = 1.0 A, di _F /dt = 200 A/μs, V _R = 30 V	-	26	-	ns
	t _{rr1}	T _J = 25 °C	-	53	80	
	t _{rr2}	T _J = 125 °C	-	87	130	
Peak recovery current	I _{RRM1}	T _J = 25 °C	-	4.4	8.0	A
	I _{RRM2}	T _J = 125 °C	-	5.0	9.0	
Reverse recovery charge	Q _{rr1}	T _J = 25 °C	-	116	320	nC
	Q _{rr2}	T _J = 125 °C	-	233	585	
Peak rate of recovery current during t _b	di _{(rec)M} /dt1	T _J = 25 °C	-	180	-	A/μs
	di _{(rec)M} /dt2	T _J = 125 °C	-	100	-	

THERMAL - MECHANICAL SPECIFICATIONS						
PARAMETER	SYMBOL	TEST CONDITIONS	MIN.	TYP.	MAX.	UNITS
Lead temperature	T _{lead}	0.063" from case (1.6 mm) for 10 s	-	-	300	°C
Thermal resistance, junction to case	R _{thJC}		-	-	2.0	K/W
Thermal resistance, junction to ambient	R _{thJA}	Typical socket mount	-	-	80	
Thermal resistance, case to heatsink	R _{thCS}	Mounting surface, flat, smooth and greased	-	0.5	-	
Weight			-	2.0	-	g
			-	0.07	-	oz.

HEXFRED® Ultrafast Soft Recovery Diode, 6 A

Vishay High Power Products

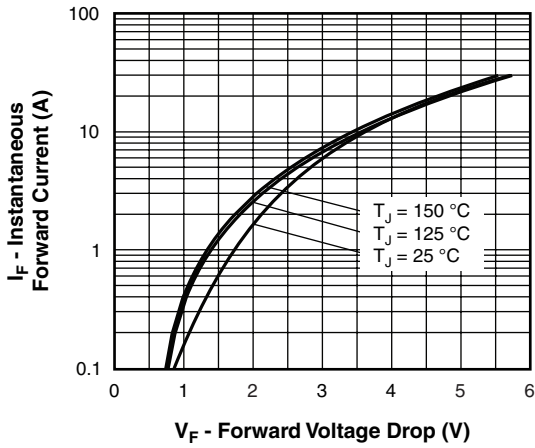

Fig. 1 - Typical Forward Voltage Drop Characteristics

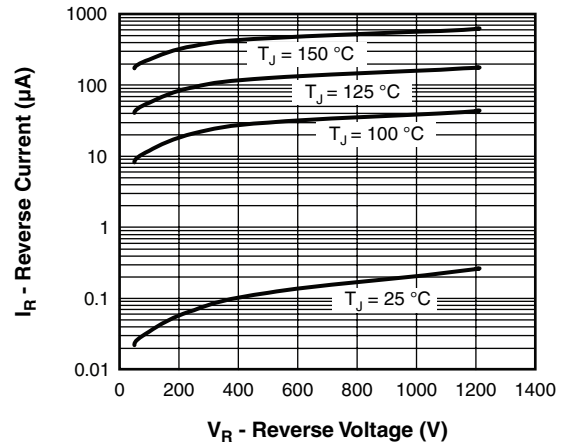

Fig. 2 - Typical Reverse Current vs. Reverse Voltage

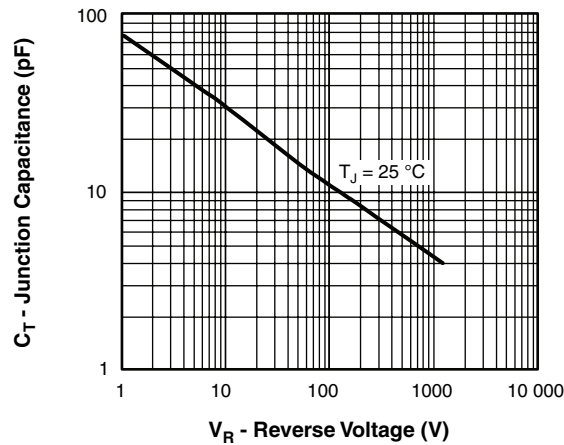

Fig. 3 - Typical Junction Capacitance vs. Reverse Voltage

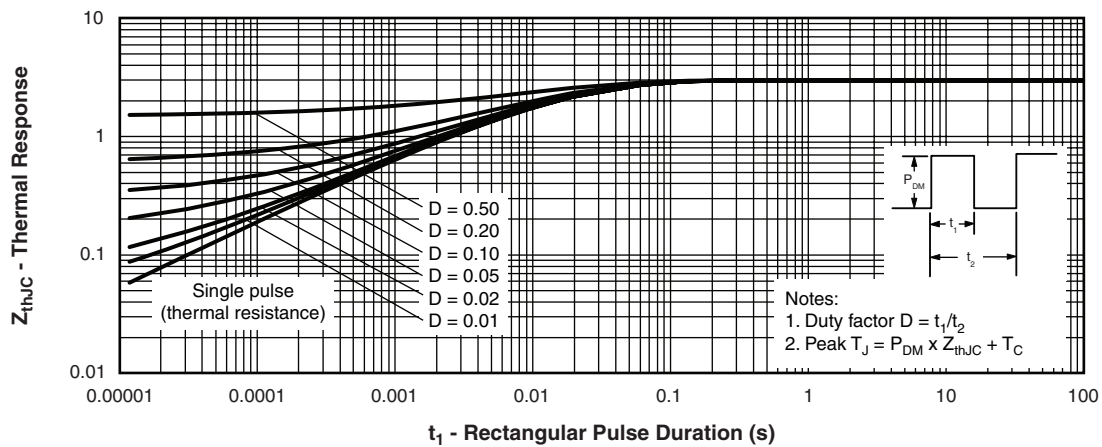

Fig. 4 - Maximum Thermal Impedance Z_{thJC} Characteristics

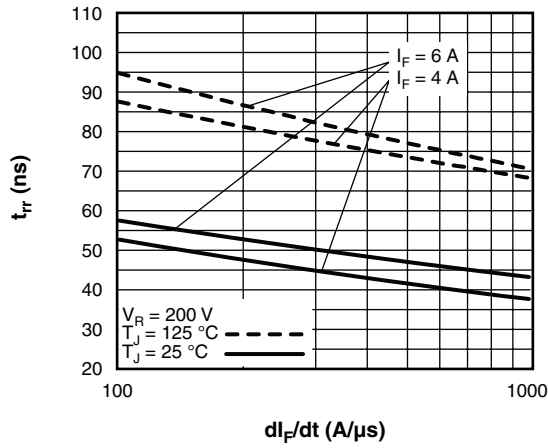

Fig. 5 - Typical Reverse Recovery Time vs. di_F/dt

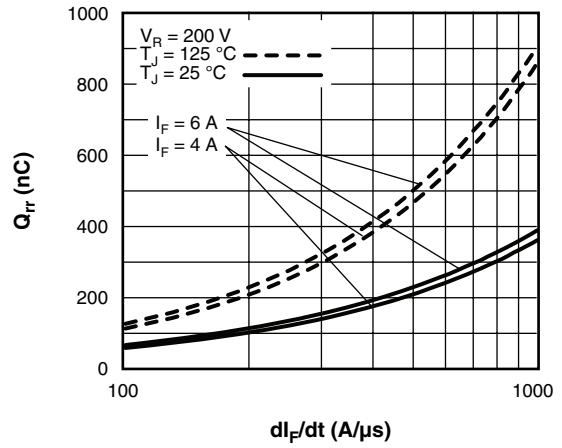

Fig. 7 - Typical Stored Charge vs. di_F/dt

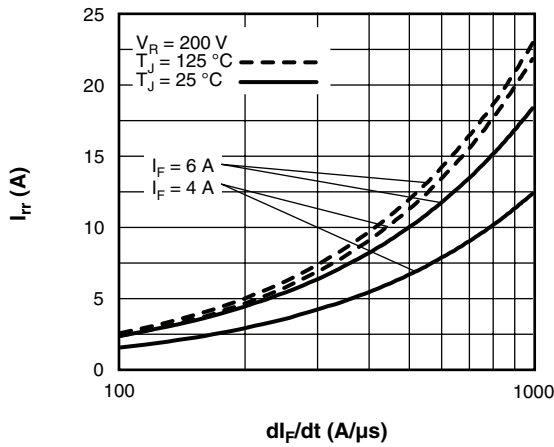

Fig. 6 - Typical Recovery Current vs. di_F/dt

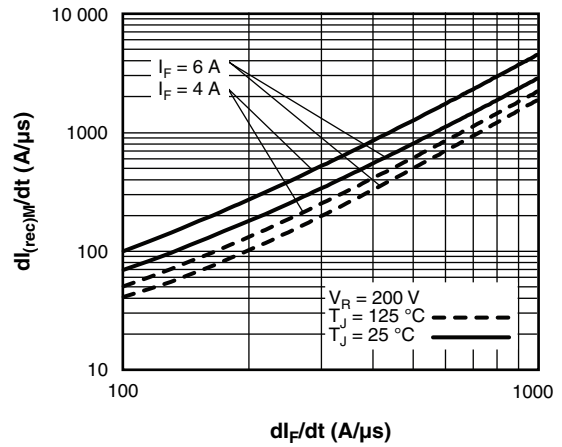

Fig. 8 - Typical $di_{(rec)M}/dt$ vs. di_F/dt

HEXFRED®
 Ultrafast Soft Recovery Diode, 6 A

Vishay High Power Products

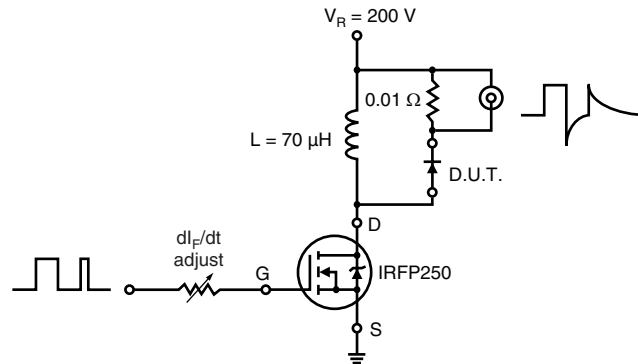
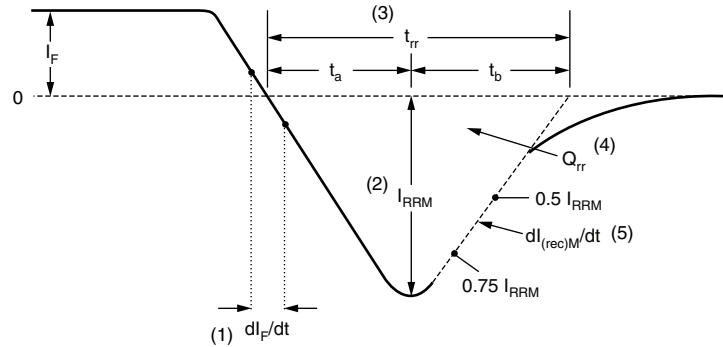

Fig. 9 - Reverse Recovery Parameter Test Circuit

 (1) di_F/dt - rate of change of current through zero crossing

 (2) I_{RRM} - peak reverse recovery current

 (3) t_{rr} - reverse recovery time measured from zero crossing point of negative going I_F to point where a line passing through $0.75 I_{RRM}$ and $0.50 I_{RRM}$ extrapolated to zero current.

 (4) Q_{rr} - area under curve defined by t_{rr} and I_{RRM}

$$Q_{rr} = \frac{t_{rr} \times I_{RRM}}{2}$$

 (5) $di_{(rec)M}/dt$ - peak rate of change of current during t_b portion of t_{rr}

Fig. 10 - Reverse Recovery Waveform and Definitions

ORDERING INFORMATION TABLE

Device code	HF	A	06	TB	120	S	TR	-
	①	②	③	④	⑤	⑥	⑦	⑧

- 1** - HEXFRED® family
- 2** - Process designator:
A = A subs. elec. irradi.
B = B subs. platinum
- 3** - Average current: 06 = 6 A
- 4** - Package outline: TB = TO-220 2 lead
- 5** - Voltage code: 120 = 1200 V
- 6** - Configuration: S = SMD
- 7** - Suffix: TR = Tape and reel
- 8** -
 - None = Standard production
 - PbF = Lead (Pb)-free

LINKS TO RELATED DOCUMENTS	
Dimensions	http://www.vishay.com/doc?95046
Part marking information	http://www.vishay.com/doc?95054
Packaging information	http://www.vishay.com/doc?95032



Disclaimer

All product specifications and data are subject to change without notice.

Vishay Intertechnology, Inc., its affiliates, agents, and employees, and all persons acting on its or their behalf (collectively, "Vishay"), disclaim any and all liability for any errors, inaccuracies or incompleteness contained herein or in any other disclosure relating to any product.

Vishay disclaims any and all liability arising out of the use or application of any product described herein or of any information provided herein to the maximum extent permitted by law. The product specifications do not expand or otherwise modify Vishay's terms and conditions of purchase, including but not limited to the warranty expressed therein, which apply to these products.

No license, express or implied, by estoppel or otherwise, to any intellectual property rights is granted by this document or by any conduct of Vishay.

The products shown herein are not designed for use in medical, life-saving, or life-sustaining applications unless otherwise expressly indicated. Customers using or selling Vishay products not expressly indicated for use in such applications do so entirely at their own risk and agree to fully indemnify Vishay for any damages arising or resulting from such use or sale. Please contact authorized Vishay personnel to obtain written terms and conditions regarding products designed for such applications.

Product names and markings noted herein may be trademarks of their respective owners.

单击下面可查看定价，库存，交付和生命周期等信息

[>>Vishay\(威世\)](#)