

Optocoupler, Phototransistor Output, Low Input Current, With Base Connection

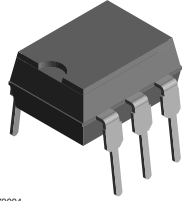

I179004

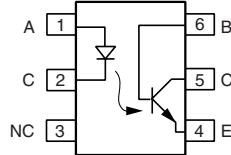

FEATURES

- Saturation CTR - MCT5211, > 100 % at $I_F = 1.6 \text{ mA}$
- High isolation voltage, 5300 V_{RMS}
- Lead (Pb)-free component
- Component in accordance to RoHS 2002/95/EC and WEEE 2002/96/EC

RoHS
COMPLIANT

DESCRIPTION

The MCT521/5211 are optocouplers with a high efficiency AlGaAs LED optically coupled to a NPN phototransistor. The high performance LED makes operation at low input currents practical. The coupler is housed in a six pin DIP package. Isolation test voltage is 5300 V_{RMS} .

Because these parts have guaranteed CTRs at 1 mA and 3 mA, they are ideally suitable for interfacing from CMOS to TTL or LSTTL to TTL. They are also ideal for telecommunications applications such as ring or off-hook detection.

AGENCY APPROVALS

- UL1577, file no. E52744 system code H or J, double protection
- BSI IEC 60950; IEC 60065
- DIN EN 60747-5-2 (VDE 0884)/DIN EN 60747-5-5 pending available with option 1
- CSA 93751

ORDER INFORMATION

PART	REMARKS
MCT5210	CTR > 70 %, DIP-6
MCT5211	CTR > 110 %, DIP-6
MCT5211-X007	CTR > 110 %, SMD-6 (option 7)
MCT5211-X009	CTR > 110 %, SMD-6 (option 9)

Note

For additional information on the available options refer to option information.

ABSOLUTE MAXIMUM RATINGS

PARAMETER	TEST CONDITION	SYMBOL	VALUE	UNIT
INPUT				
Peak reverse voltage		V_R	6.0	V
Forward continuous current		I_F	40	mA
Power dissipation		P_{diss}	75	mW
Derate linearly from 25 °C			1.0	mW/°C
OUTPUT				
Collector emitter breakdown voltage		BV_{CEO}	30	V
Emitter collector breakdown voltage		BV_{ECO}	7.0	V
Collector base breakdown voltage		BV_{CBO}	70	V
Power dissipation		P_{diss}	200	mW
Derate linearly from 25 °C			2.6	mW/°C

MCT5210/MCT5211



Vishay Semiconductors Optocoupler, Phototransistor Output,
Low Input Current, With Base Connection

ABSOLUTE MAXIMUM RATINGS				
PARAMETER	TEST CONDITION	SYMBOL	VALUE	UNIT
COUPLER				
Isolation test voltage		V_{ISO}	5300	V_{RMS}
Total package dissipation (LED and detector)		P_{tot}	260	mW
Derate linearly from 25 °C			3.5	mW/°C
Creepage distance			≥ 7	mm
Clearance distance			≥ 7	mm
Comparative tracking index per DIN IEC 112/VDE 0303, part 1		CTI	175	
Isolation resistance	$V_{IO} = 500\text{ V}, T_{amb} = 25\text{ °C}$	R_{IO}	≥ 10^{12}	Ω
	$V_{IO} = 500\text{ V}, T_{amb} = 100\text{ °C}$	R_{IO}	≥ 10^{11}	Ω
Operating temperature		T_{amp}	- 55 to + 100	°C
Storage temperature		T_{stg}	- 55 to + 150	°C

Note

$T_{amb} = 25\text{ °C}$, unless otherwise specified.

Stresses in excess of the absolute maximum ratings can cause permanent damage to the device. Functional operation of the device is not implied at these or any other conditions in excess of those given in the operational sections of this document. Exposure to absolute maximum ratings for extended periods of the time can adversely affect reliability.

ELECTRICAL CHARACTERISTICS							
PARAMETER	TEST CONDITION	PART	SYMBOL	MIN.	TYP.	MAX.	UNIT
INPUT							
Forward voltage	$I_F = 5.0\text{ mA}$		V_F		1.2	1.5	V
Reverse voltage	$I_R = 10\text{ μA}$		V_R	6.0			V
OUTPUT							
DC forward current gain	$V_{CE} = 5.0\text{ V}, I_C = 100\text{ μA}$		h_{FE}	100	200		
Collector emitter breakdown voltage	$I_C = 100\text{ μA}$		BV_{CEO}	30			V
Emitter collector breakdown voltage	$I_E = 100\text{ μA}$		BV_{ECO}	7.0			V
Collector base breakdown voltage	$I_E = 10\text{ μA}$		BV_{CBO}	70			V
Collector emitter leakage voltage	$V_{CE} = 10\text{ V}$		I_{CEO}		5.0	100	nA
COUPLER							
Saturation voltage	$I_F = 3.0\text{ mA}, I_C = 1.8\text{ mA}$	MCT5210	V_{CEsat}		0.25	0.4	V
	$I_F = 1.6\text{ mA}, I_C = 1.6\text{ mA}$	MCT5211	V_{CEsat}		0.25	0.4	V

Note

$T_{amb} = 25\text{ °C}$, unless otherwise specified

Minimum and maximum values are testing requirements. Typical values are characteristics of the device and are the result of engineering evaluation. Typical values are for information only and are not part of the testing requirements.

CURRENT TRANSFER RATIO							
PARAMETER	TEST CONDITION	PART	SYMBOL	MIN.	TYP.	MAX.	UNIT
Current transfer ratio (collector emitter saturated)	$V_{CE} = 0.4\text{ V}, I_F = 3.0\text{ mA}$	MCT5210	CTR_{CEsat}	60	120		%
	$V_{CE} = 0.4\text{ V}, I_F = 1.6\text{ mA}$	MCT5211	CTR_{CEsat}	100	200		%
	$V_{CE} = 0.4\text{ V}, I_F = 1.0\text{ mA}$	MCT5211	CTR_{CEsat}	75	150		%
Current transfer ratio	$V_{CE} = 5.0\text{ mA}, I_F = 3.0\text{ mA}$	MCT5210	CTR	70	150		%
	$V_{CE} = 5.0\text{ mA}, I_F = 1.6\text{ mA}$	MCT5211	CTR	150	300		%
	$V_{CE} = 5.0\text{ mA}, I_F = 1.0\text{ mA}$	MCT5211	CTR	110	225		%
Current transfer ratio (collector base)	$V_{CE} = 4.3\text{ V}, I_F = 3.0\text{ mA}$	MCT5210	CTR_{CB}	0.2	0.4		%
	$V_{CE} = 4.3\text{ V}, I_F = 1.6\text{ mA}$	MCT5211	CTR_{CB}	0.3	0.6		%
	$V_{CE} = 4.3\text{ V}, I_F = 1.0\text{ mA}$	MCT5211	CTR_{CB}	0.25	0.5		%

Optocoupler, Phototransistor Output, Vishay Semiconductors Low Input Current, With Base Connection

SWITCHING CHARACTERISTICS							
PARAMETER	TEST CONDITION	PART	SYMBOL	MIN.	TYP.	MAX.	UNIT
Propagation delay high to low	$R_L = 330 \Omega$, $I_F = 3.0 \text{ mA}$, $V_{CC} = 5.0 \text{ V}$	MCT5210	t_{PHL}		10		μs
	$R_L = 750 \Omega$, $I_F = 1.6 \text{ mA}$, $V_{CC} = 5.0 \text{ V}$	MCT5211	t_{PHL}		20		μs
	$R_L = 1.5 \text{ k}\Omega$, $I_F = 1.0 \text{ mA}$, $V_{CC} = 5.0 \text{ V}$	MCT5211	t_{PHL}		40		μs
Propagation delay low to high	$R_L = 330 \Omega$, $I_F = 3.0 \text{ mA}$, $V_{CC} = 5.0 \text{ V}$	MCT5210	t_{PLH}		10		μs
	$R_L = 750 \Omega$, $I_F = 1.6 \text{ mA}$, $V_{CC} = 5.0 \text{ V}$	MCT5211	t_{PLH}		20		μs
	$R_L = 1.5 \text{ k}\Omega$, $I_F = 1.0 \text{ mA}$, $V_{CC} = 5.0 \text{ V}$	MCT5211	t_{PLH}		40		μs

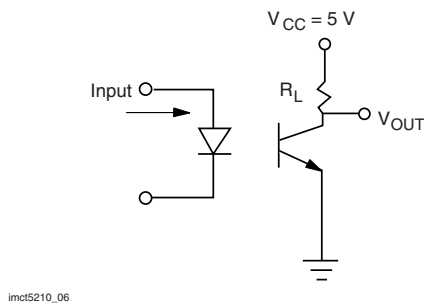

Fig. 1 - Switching Schematic

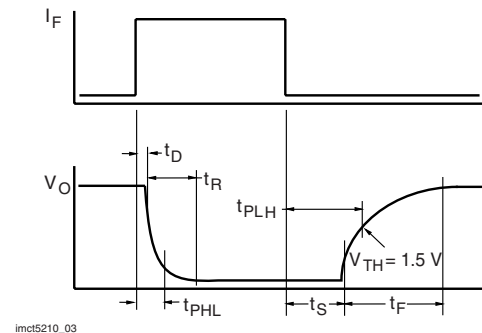

Fig. 2 - Switching Waveform

TYPICAL CHARACTERISTICS

$T_{amb} = 25 \text{ }^\circ\text{C}$ unless otherwise specified

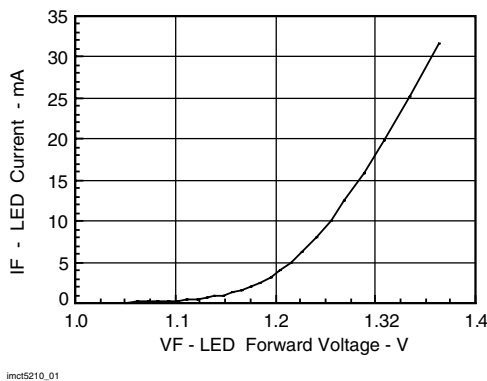

Fig. 3 - Forward Current vs. Forward Voltage

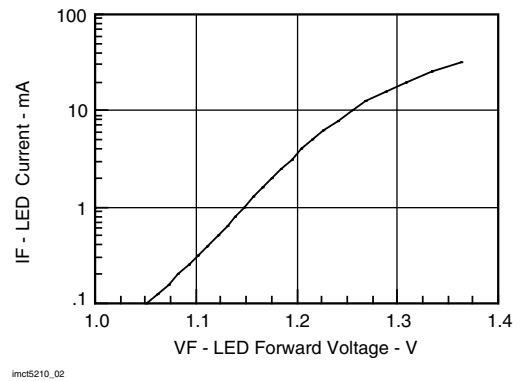
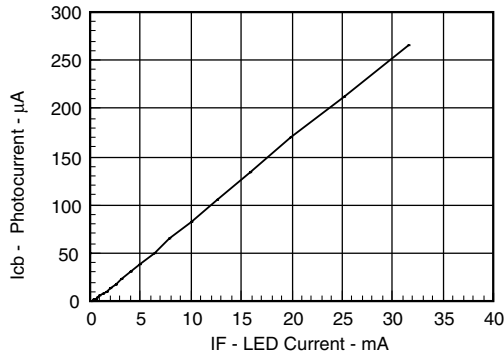
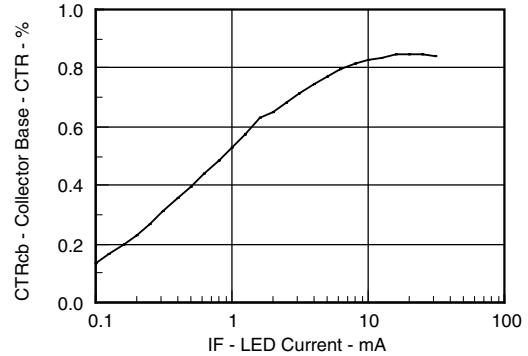

Fig. 4 - LED Forward Current vs. Forward Voltage



imct5210_04

Fig. 5 - Collector Base Photocurrent vs. LED Current



imct5210_08

Fig. 8 - Collector Base CTR vs. LED Current

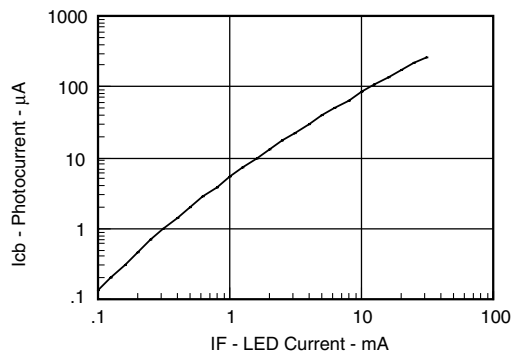

imct5210_05

Fig. 6 - Photocurrent vs. LED Current

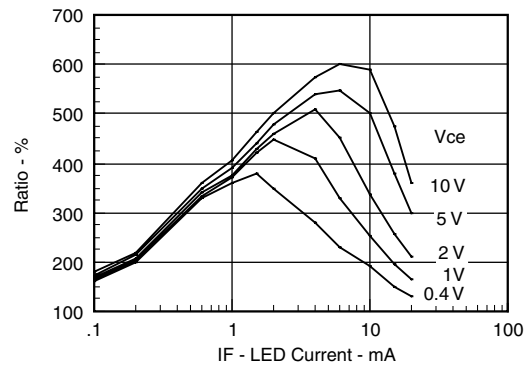

imct5210_09

Fig. 9 - CTR vs. LED Current

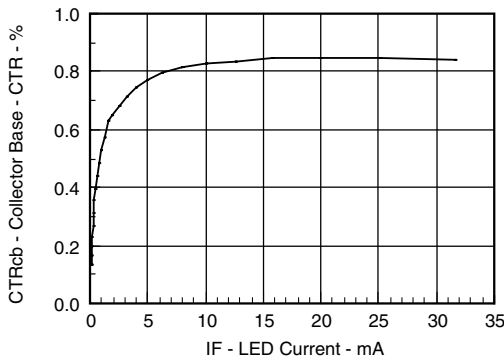

imct5210_07

Fig. 7 - Collector Base CTR vs. LED Current

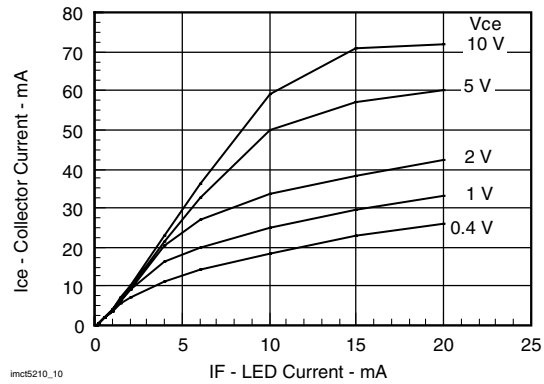

imct5210_10

Fig. 10 - Collector Current vs. LED Current



Optocoupler, Phototransistor Output, Vishay Semiconductors
Low Input Current, With Base Connection

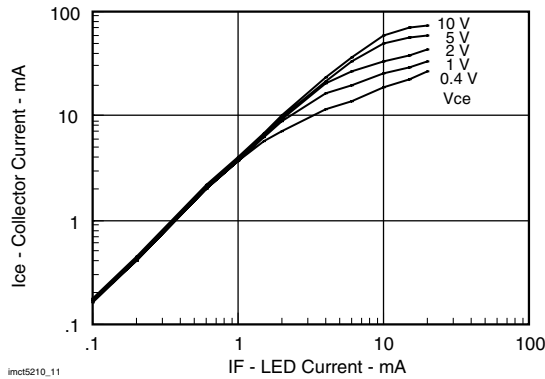

Fig. 11 - Collector Current vs. LED Current

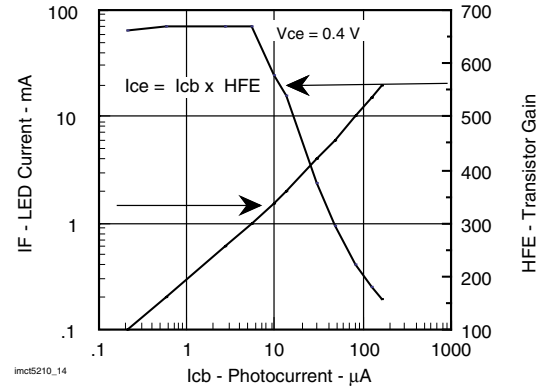

Fig. 14 - Transfer Curve

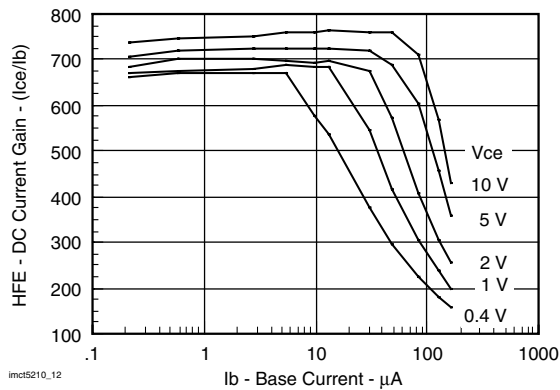

Fig. 12 - Transistor Current Gain vs. Base Current

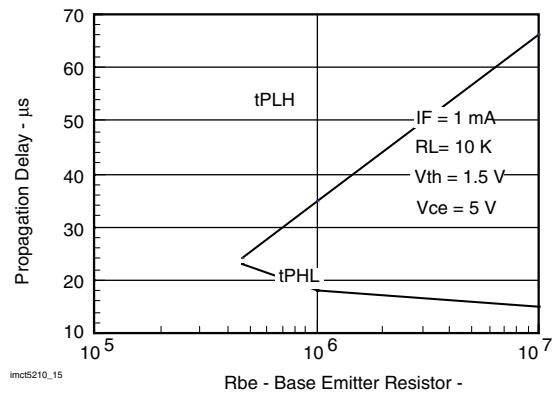

Fig. 15 - Propagation Delay vs. Base Emitter Resistor

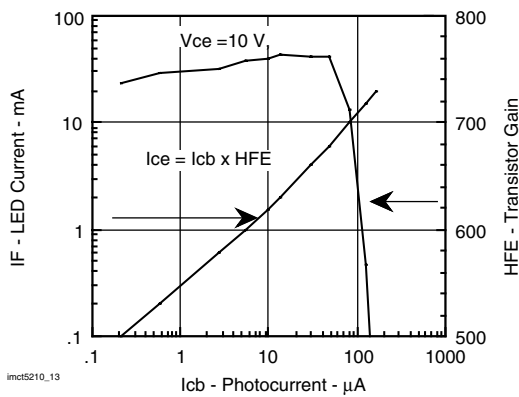

Fig. 13 - Transfer Curve

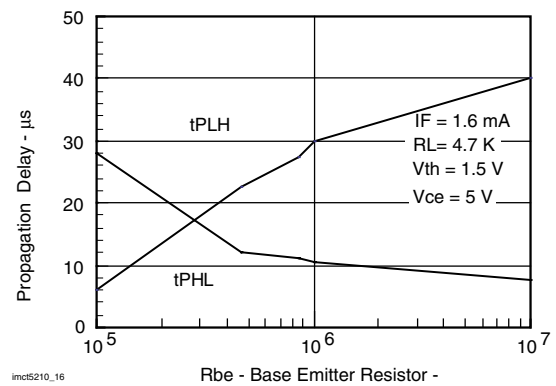

Fig. 16 - Propagation Delay vs. Base Emitter Resistor

MCT5210/MCT5211



Vishay Semiconductors Optocoupler, Phototransistor Output,
Low Input Current, With Base Connection

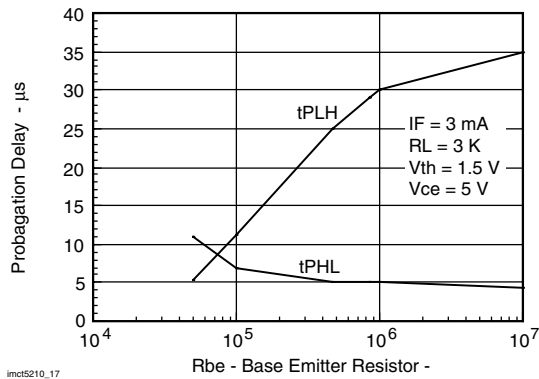
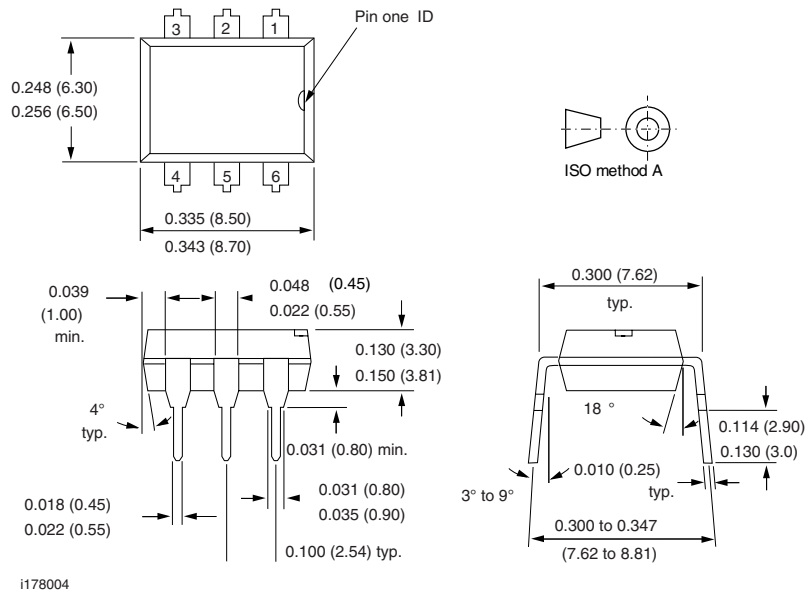
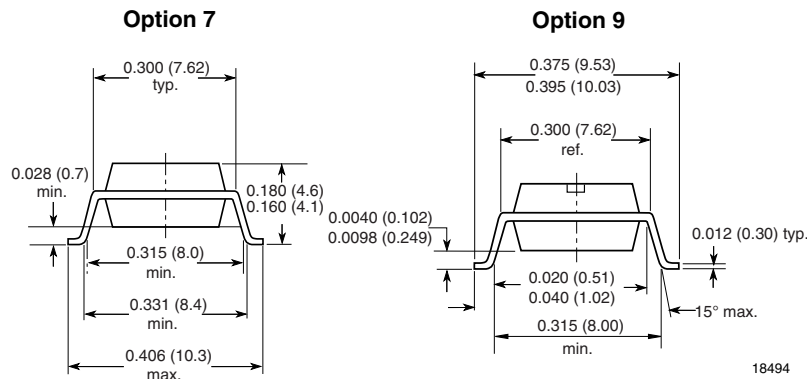

Fig. 17 - Propagation Delay vs. Base Emitter Resistor

PACKAGE DIMENSIONS in Inches (millimeters)



i178004



18494



Optocoupler, Phototransistor Output, Vishay Semiconductors
Low Input Current, With Base
Connection

OZONE DEPLETING SUBSTANCES POLICY STATEMENT

It is the policy of Vishay Semiconductor GmbH to

1. Meet all present and future national and international statutory requirements.
2. Regularly and continuously improve the performance of our products, processes, distribution and operating systems with respect to their impact on the health and safety of our employees and the public, as well as their impact on the environment.

It is particular concern to control or eliminate releases of those substances into the atmosphere which are known as ozone depleting substances (ODSs).

The Montreal Protocol (1987) and its London Amendments (1990) intend to severely restrict the use of ODSs and forbid their use within the next ten years. Various national and international initiatives are pressing for an earlier ban on these substances.

Vishay Semiconductor GmbH has been able to use its policy of continuous improvements to eliminate the use of ODSs listed in the following documents.

1. Annex A, B and list of transitional substances of the Montreal Protocol and the London Amendments respectively.
2. Class I and II ozone depleting substances in the Clean Air Act Amendments of 1990 by the Environmental Protection Agency (EPA) in the USA.
3. Council Decision 88/540/EEC and 91/690/EEC Annex A, B and C (transitional substances) respectively.

Vishay Semiconductor GmbH can certify that our semiconductors are not manufactured with ozone depleting substances and do not contain such substances.

We reserve the right to make changes to improve technical design
and may do so without further notice.

Parameters can vary in different applications. All operating parameters must be validated for each customer application by the customer. Should the buyer use Vishay Semiconductors products for any unintended or unauthorized application, the buyer shall indemnify Vishay Semiconductors against all claims, costs, damages, and expenses, arising out of, directly or indirectly, any claim of personal damage, injury or death associated with such unintended or unauthorized use.

Vishay Semiconductor GmbH, P.O.B. 3535, D-74025 Heilbronn, Germany



Disclaimer

All product specifications and data are subject to change without notice.

Vishay Intertechnology, Inc., its affiliates, agents, and employees, and all persons acting on its or their behalf (collectively, "Vishay"), disclaim any and all liability for any errors, inaccuracies or incompleteness contained herein or in any other disclosure relating to any product.

Vishay disclaims any and all liability arising out of the use or application of any product described herein or of any information provided herein to the maximum extent permitted by law. The product specifications do not expand or otherwise modify Vishay's terms and conditions of purchase, including but not limited to the warranty expressed therein, which apply to these products.

No license, express or implied, by estoppel or otherwise, to any intellectual property rights is granted by this document or by any conduct of Vishay.

The products shown herein are not designed for use in medical, life-saving, or life-sustaining applications unless otherwise expressly indicated. Customers using or selling Vishay products not expressly indicated for use in such applications do so entirely at their own risk and agree to fully indemnify Vishay for any damages arising or resulting from such use or sale. Please contact authorized Vishay personnel to obtain written terms and conditions regarding products designed for such applications.

Product names and markings noted herein may be trademarks of their respective owners.

单击下面可查看定价，库存，交付和生命周期等信息

[>>Vishay\(威世\)](#)