

Surface Mount TRANSZORB® Transient Voltage Suppressors


SMC (DO-214AB)


LINKS TO ADDITIONAL RESOURCES



PRIMARY CHARACTERISTICS	
V_{BR}	11.1 V to 147 V
V_{WM}	10 V to 120 V
P_{PPM}	3000 W
T_J max.	175 °C
Polarity	Bidirectional
Package	SMC (DO-214AB)

FEATURES

- Bidirectional
- Peak pulse power
 - 3000 W (10/1000 μ s)
 - 30 kW (8/20 μ s)
- Excellent clamping capability
- Very fast response time
- Low incremental surge resistance
- Meets MSL level 1, per J-STD-020, LF maximum peak of 260 °C
- AEC-Q101 qualified
- UL recognition for safety 497B with file number E136766
- Material categorization: for definitions of compliance please see www.vishay.com/doc?99912



RoHS
COMPLIANT
HALOGEN
FREE
Available

TYPICAL APPLICATIONS

Use in sensitive electronics protection against voltage transients induced by inductive load switching and lighting on ICs, MOSFET, signal lines of sensor units for consumer, computer, industrial, automotive and telecommunication.

Meets to specification of:

ISO 7637-2:2011 Pulse 1, Pulse 2a, Pulse 3a, Pulse 3b
ISO 16750-2 Pulse b

MECHANICAL DATA

Case: SMC (DO-214AB)

Molding compound meets UL 94 V-0 flammability rating
Base P/NHM3_A - halogen-free, RoHS-compliant, and AEC-Q101 qualified

Terminals: matte tin plated leads, solderable per J-STD-002 and JESD 22-B102

HM3 suffix meets JESD 201 class 2 whisker test

Polarity: no marking on bidirectional types

MAXIMUM RATINGS ($T_A = 25$ °C unless otherwise noted)			
PARAMETER	SYMBOL	VALUE	UNIT
Peak pulse power dissipation with a 10/1000 μ s waveform (fig.1)	$P_{PPM}^{(1)}$	3000	W
Peak pulse current with a 10/1000 μ s waveform	$I_{PPM}^{(1)}$	See next table	A
Operating junction and storage temperature range	T_J, T_{STG}	-55 to +175	°C

Note

(1) Non-repetitive current pulse and derated above $T_A = 25$ °C



ELECTRICAL CHARACTERISTICS (T _A = 25 °C unless otherwise noted)										
DEVICE TYPE	DEVICE MARKING CODE	BREAKDOWN VOLTAGE V _{BR} ⁽¹⁾ (V) AT I _T		TEST CURRENT I _T (mA)	STAND-OFF VOLTAGE V _{WM} (V)	MAXIMUM REVERSE LEAKAGE AT V _{WM} I _D (µA)	MAXIMUM CLAMPING VOLTAGE V _C (V) AT I _{PPM}		MAXIMUM CLAMPING VOLTAGE V _C (V) AT I _{PPM}	
		MIN.	MAX.				10/1000 µs		8/20 µs	
							(V)	(A)	(V)	(A)
SMC3K10CAHM3_A	3BDX	11.1	12.3	1.0	10	10.0	17.0	176	24.1	1245
SMC3K12CAHM3_A	3BEE	13.3	14.7	1.0	12	5.0	19.9	151	25.3	1186
SMC3K13CAHM3_A	3GEG	14.4	15.9	1.0	13	2.0	21.5	140	27.2	1103
SMC3K14CAHM3_A	3BEK	15.6	17.2	1.0	14	2.0	23.2	129	30.0	1000
SMC3K15CAHM3_A	3BEM	16.7	18.5	1.0	15	2.0	24.4	123	32.5	923
SMC3K16CAHM3_A	3GEP	17.8	19.7	1.0	16	2.0	26.0	115	34.4	872
SMC3K17CAHM3_A	3GER	18.9	20.9	1.0	17	2.0	27.6	109	37.0	811
SMC3K18CAHM3_A	3BET	20.0	22.1	1.0	18	2.0	29.2	103	39.3	763
SMC3K20CAHM3_A	3EEV	22.2	24.5	1.0	20	2.0	32.4	92.6	42.8	701
SMC3K22CAHM3_A	3BEX	24.4	26.9	1.0	22	1.0	35.5	84.5	48.2	622
SMC3K24CAHM3_A	3BEZ	26.7	29.5	1.0	24	1.0	38.9	77.1	51.6	581
SMC3K26CAHM3_A	3BFE	28.9	31.9	1.0	26	1.0	42.1	71.3	55.8	538
SMC3K28CAHM3_A	3BFG	31.1	34.4	1.0	28	1.0	45.4	66.1	60.2	498
SMC3K30CAHM3_A	3BFK	33.3	36.8	1.0	30	1.0	48.4	62.0	64.0	469
SMC3K33CAHM3_A	3BFM	36.7	40.6	1.0	33	1.0	53.3	56.3	69.8	430
SMC3K36CAHM3_A	3BFP	40.0	44.2	1.0	36	1.0	58.1	51.6	76.0	395
SMC3K40CAHM3_A	3BFR	44.4	49.1	1.0	40	1.0	64.5	46.5	84.0	357
SMC3K43CAHM3_A	3BFT	47.8	52.8	1.0	43	1.0	69.4	43.2	90.3	332
SMC3K45CAHM3_A	3GFV	50.0	55.3	1.0	45	1.0	72.7	41.3	94.6	317
SMC3K48CAHM3_A	3GFX	53.3	58.9	1.0	48	1.0	77.4	38.8	100	300
SMC3K51CAHM3_A	3GFZ	56.7	62.7	1.0	51	1.0	82.4	36.4	107	280
SMC3K54CAHM3_A	3GGE	60.0	66.3	1.0	54	1.0	87.1	34.4	113	265
SMC3K58CAHM3_A	3GGG	64.4	71.2	1.0	58	1.0	93.6	32.1	121	248
SMC3K60CAHM3_A	3GGK	66.7	73.7	1.0	60	1.0	96.8	31.0	125	240
SMC3K64CAHM3_A	3GGM	71.1	78.6	1.0	64	1.0	103	29.1	134	224
SMC3K70CAHM3_A	3GGP	77.8	86.0	1.0	70	1.0	113	26.5	146	205
SMC3K75CAHM3_A	3GGR	83.3	92.1	1.0	75	1.0	121	24.8	157	191
SMC3K78CAHM3_A	3GGT	86.7	95.8	1.0	78	1.0	126	23.8	163	184
SMC3K85CAHM3_A	3GGV	94.4	104	1.0	85	1.0	137	21.9	177	169
SMC3K90CAHM3_A	3GGX	100	111	1.0	90	1.0	146	20.5	189	159
SMC3K100CAHM3_A	3GGZ	111	123	1.0	100	1.0	162	18.5	209	144
SMC3K110CAHM3_A	3GHE	122	135	1.0	110	1.0	177	16.9	230	130
SMC3K120CAHM3_A	3GHG	133	147	1.0	120	1.0	193	15.5	250	120

Notes

- (1) Pulse test: t_p ≤ 50 ms
- (2) All terms and symbols are consistent with ANSI/IEEE C62.35

IMMUNITY TO STATIC ELECTRICAL DISCHARGE TO THE FOLLOWING STANDARDS (T _A = 25 °C unless otherwise noted)				
STANDARD	TEST TYPE	TEST CONDITIONS	SYMBOL	VALUE
IEC 61000-4-2	Human body model (contact mode)	C = 150 pF, R = 330 Ω	ESD	30 kV
	Human body model (air discharge mode)			30 kV



THERMAL CHARACTERISTICS (T _A = 25 °C unless otherwise noted)			
PARAMETER	SYMBOL	TYP.	UNIT
Thermal resistance	R _{thJA} ⁽¹⁾	90	°C/W
	R _{thJM} ⁽²⁾	4.0	°C/W

Notes

- (1) Thermal resistance junction-to-ambient to follow JEDEC® 51-2A, device mounted on FR4 PCB, 2 oz. standard footprint
- (2) Thermal resistance junction-to-mount to follow JEDEC® 51-14 using Transient Dual Interface Test Method (TDIM)

ORDERING INFORMATION (Example)				
PREFERRED P/N	UNIT WEIGHT (g)	PREFERRED PACKAGE CODE	BASE QUANTITY	DELIVERY MODE
SMC3K10CAHM3_A/H ⁽¹⁾	0.257	H	850	7" diameter plastic tape and reel
SMC3K10CAHM3_A/I ⁽¹⁾	0.257	I	3500	13" diameter plastic tape and reel

Note

- (1) AEC-Q101 qualified

RATINGS AND CHARACTERISTICS CURVES (T_A = 25 °C unless otherwise noted)

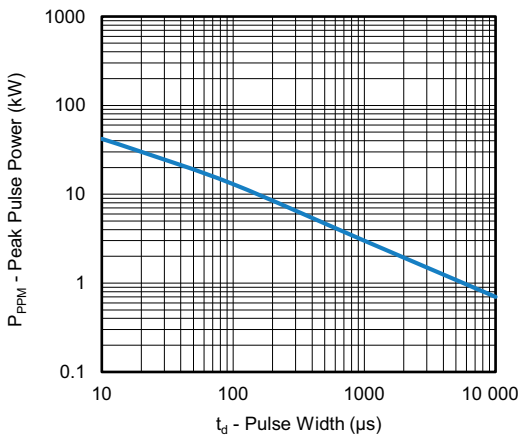


Fig. 1 - Peak Pulse Power Derating Curve

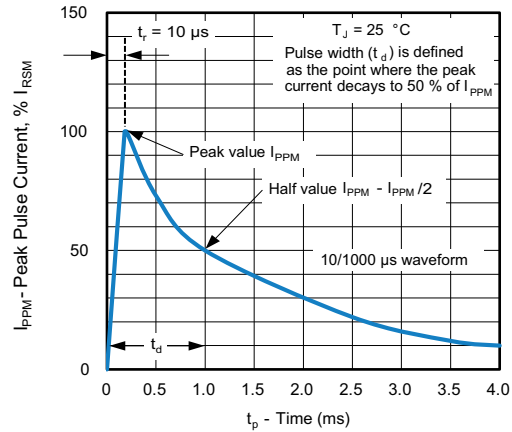


Fig. 3 - 10/1000 µs Pulse Waveform

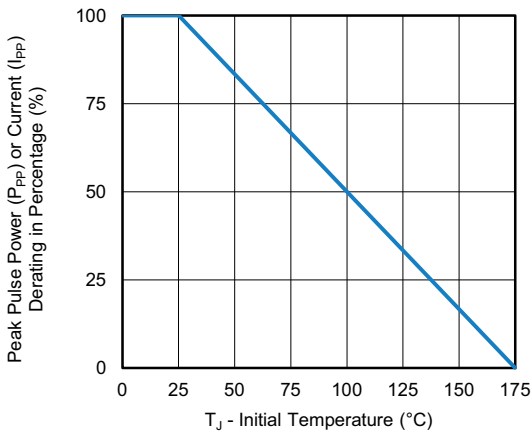


Fig. 2 - Pulse Power or Current vs. Initial Junction Temperature

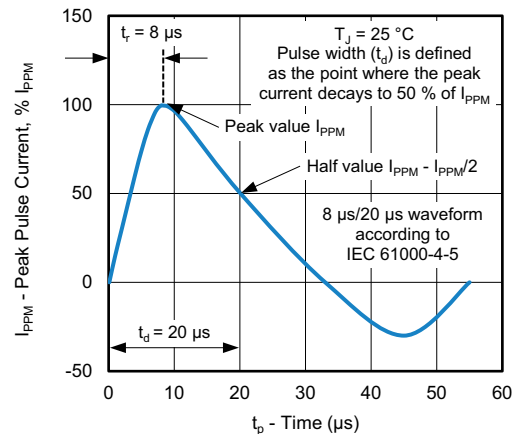


Fig. 4 - 8/20 µs Pulse Waveform

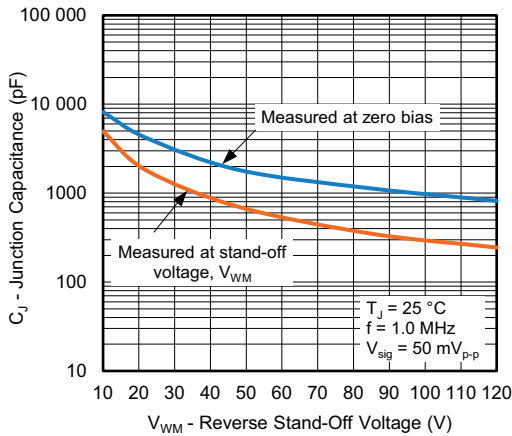


Fig. 5 - Typical Junction Capacitance

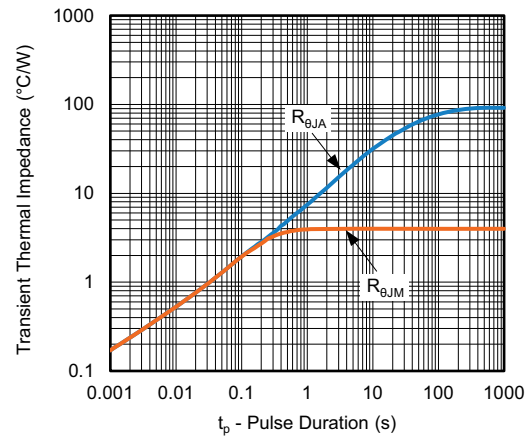


Fig. 6 - Typical Transient Thermal Impedance

Notes

- (1) Fig. 1 - Power calculation is based on I_{PPM} times defined maximum clamping voltage by pulse width
- (2) Fig. 1 - 10 000 μs P_{PPM} is actual test for $V_{WM} \leq 60$ V types, over 60 V types 10 000 P_{PPM} is curve extensional value

TYPICAL CLAMPING VOLTAGE AT ISO7637-2 WITH 12 V BATTERY SYSTEM ($T_A = 25^\circ C$)				
CONDITION	PULSE 1	PULSE 2a	PULSE 3a	PULSE 3b
		-150 V U_S , 2 ms, 10 Ω 0.5 s Interval 5000 pulses	112 V U_S , 50 μs , 2 Ω 0.2 s Interval 5000 pulses	-220 V U_S , 150 ns, 50 Ω 100 μs Interval (10 kHz) 1 h
Device type				
SMC3K24CAHM3_A	-33 V	33 V	-30 V	35 V
SMC3K26CAHM3_A	-35 V	35 V	-32 V	37 V
SMC3K28CAHM3_A	-38 V	38 V	-34 V	40 V
SMC3K30CAHM3_A	-40 V	40 V	-36 V	42 V
SMC3K33CAHM3_A	-43 V	43 V	-39 V	45 V

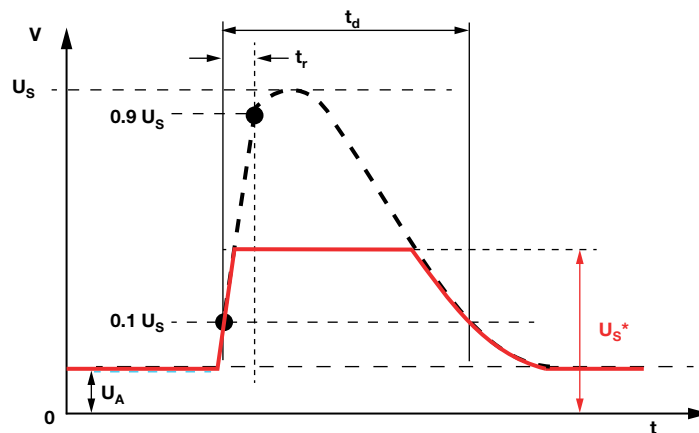
TYPICAL LOAD DUMP CAPABILITY AT ISO 16750-2 PULSE B WITH 12 V BATTERY SYSTEM ($T_A = 25^\circ C$)


Fig. 7

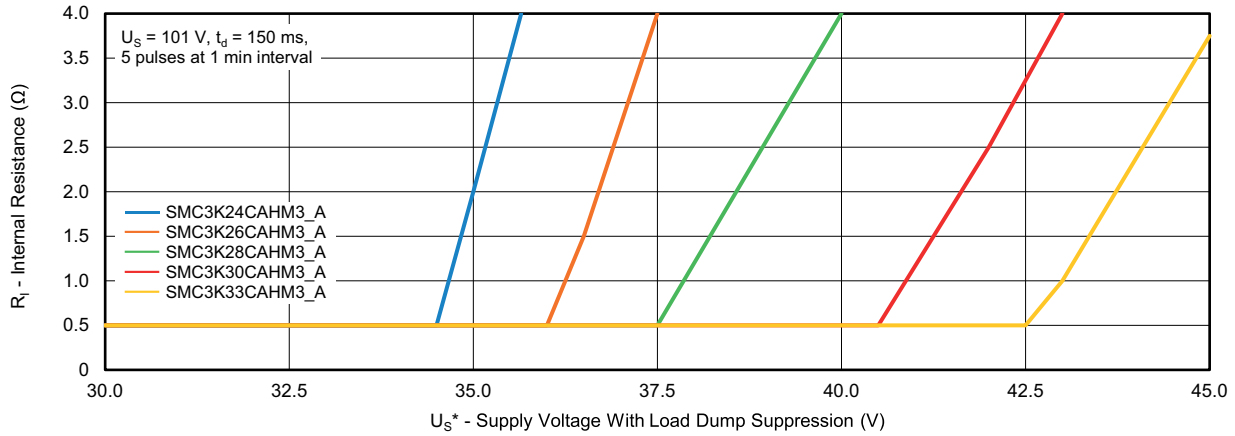


Fig. 8

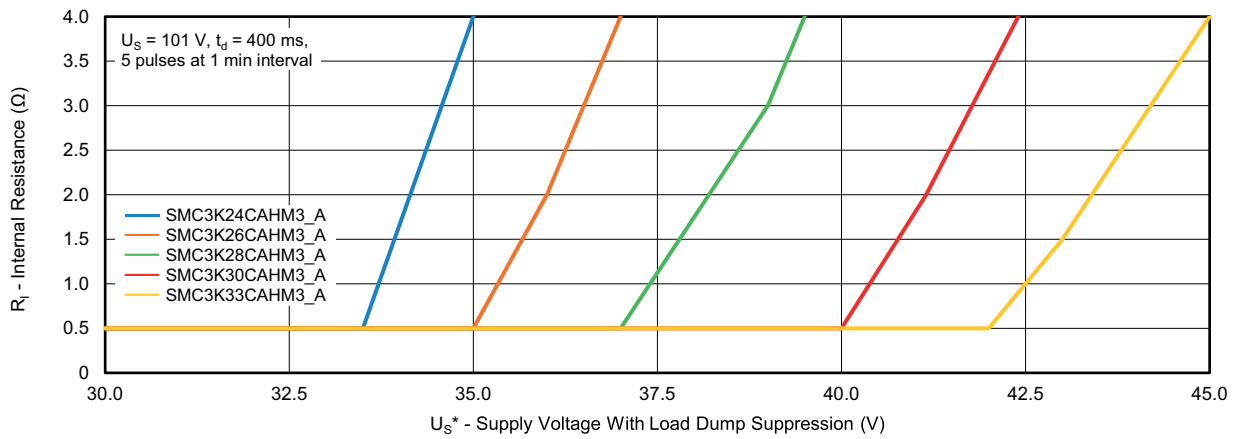
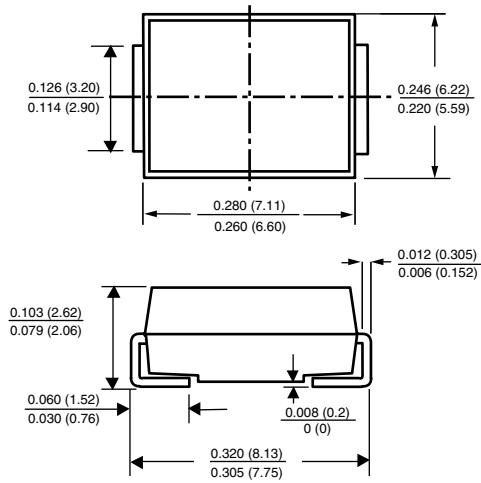


Fig. 9

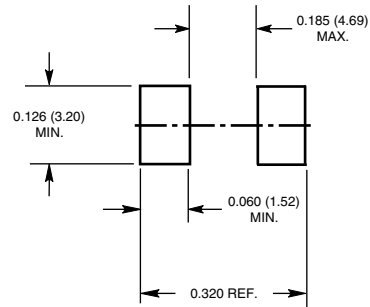


PACKAGE OUTLINE DIMENSIONS in inches (millimeters)

SMC (DO-214AB)



Mounting Pad Layout





Disclaimer

ALL PRODUCT, PRODUCT SPECIFICATIONS AND DATA ARE SUBJECT TO CHANGE WITHOUT NOTICE TO IMPROVE RELIABILITY, FUNCTION OR DESIGN OR OTHERWISE.

Vishay Intertechnology, Inc., its affiliates, agents, and employees, and all persons acting on its or their behalf (collectively, "Vishay"), disclaim any and all liability for any errors, inaccuracies or incompleteness contained in any datasheet or in any other disclosure relating to any product.

Vishay makes no warranty, representation or guarantee regarding the suitability of the products for any particular purpose or the continuing production of any product. To the maximum extent permitted by applicable law, Vishay disclaims (i) any and all liability arising out of the application or use of any product, (ii) any and all liability, including without limitation special, consequential or incidental damages, and (iii) any and all implied warranties, including warranties of fitness for particular purpose, non-infringement and merchantability.

Statements regarding the suitability of products for certain types of applications are based on Vishay's knowledge of typical requirements that are often placed on Vishay products in generic applications. Such statements are not binding statements about the suitability of products for a particular application. It is the customer's responsibility to validate that a particular product with the properties described in the product specification is suitable for use in a particular application. Parameters provided in datasheets and / or specifications may vary in different applications and performance may vary over time. All operating parameters, including typical parameters, must be validated for each customer application by the customer's technical experts. Product specifications do not expand or otherwise modify Vishay's terms and conditions of purchase, including but not limited to the warranty expressed therein.

Hyperlinks included in this datasheet may direct users to third-party websites. These links are provided as a convenience and for informational purposes only. Inclusion of these hyperlinks does not constitute an endorsement or an approval by Vishay of any of the products, services or opinions of the corporation, organization or individual associated with the third-party website. Vishay disclaims any and all liability and bears no responsibility for the accuracy, legality or content of the third-party website or for that of subsequent links.

Except as expressly indicated in writing, Vishay products are not designed for use in medical, life-saving, or life-sustaining applications or for any other application in which the failure of the Vishay product could result in personal injury or death. Customers using or selling Vishay products not expressly indicated for use in such applications do so at their own risk. Please contact authorized Vishay personnel to obtain written terms and conditions regarding products designed for such applications.

No license, express or implied, by estoppel or otherwise, to any intellectual property rights is granted by this document or by any conduct of Vishay. Product names and markings noted herein may be trademarks of their respective owners.

单击下面可查看定价，库存，交付和生命周期等信息

[>>Vishay\(威世\)](#)