

International IR Rectifier

201CMQ... SERIES

SCHOTTKY RECTIFIER

200 Amp

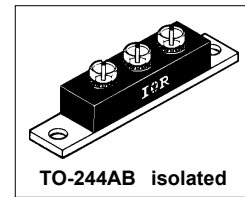

Major Ratings and Characteristics

Characteristics	201CMQ...	Units
$I_{F(AV)}$ Rectangular waveform	200	A
V_{RRM}	35 to 45	V
I_{FSM} @tp = 5 μ s sine	16,000	A
V_F @100Apk, $T_J = 125^\circ\text{C}$ (per leg)	0.58	V
T_J range	-55 to 175	$^\circ\text{C}$

Description/Features

The 201CMQ high current Schottky rectifier module series has been optimized for low reverse leakage at high temperature.

The proprietary barrier technology allows for reliable operation up to 175 $^\circ\text{C}$ junction temperature. Typical applications are in high current switching power supplies, plating power supplies, UPS systems, converters, free-wheeling diodes, welding, and reverse battery protection.

- 175 $^\circ\text{C}$ T_J operation
- Center tap module - Isolated Base
- High purity, high temperature epoxy encapsulation for enhanced mechanical strength and moisture resistance
- Low forward voltage drop
- High frequency operation
- Guard ring for enhanced ruggedness and long term reliability

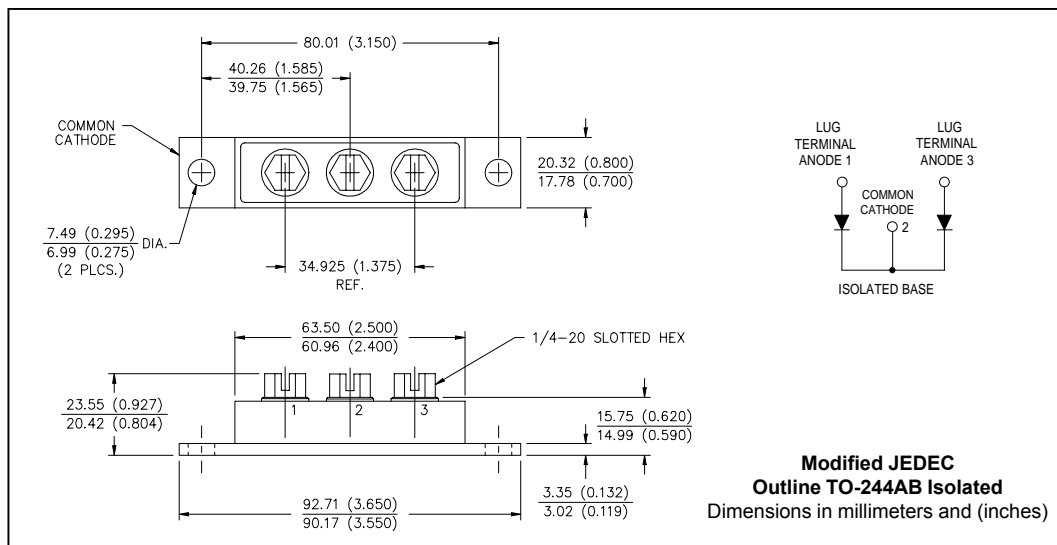

Voltage Ratings

Part number	201CMQ035	201CMQ040	201CMQ045
V_R Max. DC Reverse Voltage (V)	35	40	45
V_{RWM} Max. Working Peak Reverse Voltage (V)			

Absolute Maximum Ratings

Parameters	201CMQ	Units	Conditions
$I_{F(AV)}$ Max. Average Forward (Per Leg) Current * See Fig. 5 (Per Device)	100	A	50% duty cycle @ $T_C = 121^\circ\text{C}$, rectangular wave form
	200		
I_{FSM} Max. Peak One Cycle Non-Repetitive Surge Current (Per Leg) * See Fig. 7	16,000	A	5 μs Sine or 3 μs Rect. pulse 10ms Sine or 6ms Rect. pulse Following any rated load condition and with rated V_{RRM} applied
	3200		
E_{AS} Non-Repetitive Avalanche Energy (Per Leg)	135	mJ	$T_J = 25^\circ\text{C}$, $I_{AS} = 20$ Amps, $L = 0.67$ mH
I_{AR} Repetitive Avalanche Current (Per Leg)	20	A	Current decaying linearly to zero in 1 μsec Frequency limited by T_J max. $V_A = 1.5 \times V_R$ typical

Electrical Specifications

Parameters	201CMQ	Units	Conditions
V_{FM} Max. Forward Voltage Drop (Per Leg) * See Fig. 1 (1)	0.67	V	@ 100A $T_J = 25^\circ\text{C}$
	0.81	V	@ 200A
	0.58	V	@ 100A $T_J = 125^\circ\text{C}$
	0.71	V	@ 200A
I_{RM} Max. Reverse Leakage Current (Per Leg) * See Fig. 2 (1)	10	mA	$T_J = 25^\circ\text{C}$
	90	mA	$T_J = 125^\circ\text{C}$ $V_R = \text{rated } V_R$
C_T Max. Junction Capacitance (Per Leg)	5200	pF	$V_R = 5V_{DC}$, (test signal range 100Khz to 1Mhz) 25°C
L_S Typical Series Inductance (Per Leg)	7.0	nH	From top of terminal hole to mounting plane
dv/dt Max. Voltage Rate of Change	10000	V/ μs	(Rated V_R)
V_{RMS} Insulation Voltage	1000	V	

(1) Pulse Width < 300 μs , Duty Cycle <2%

Thermal-Mechanical Specifications

Parameters	201CMQ	Units	Conditions
T_J Max. Junction Temperature Range	-55 to 175	$^\circ\text{C}$	
T_{stg} Max. Storage Temperature Range	-55 to 175	$^\circ\text{C}$	
R_{thJC} Max. Thermal Resistance Junction to Case (Per Leg)	0.70	$^\circ\text{C/W}$	DC operation * See Fig. 4
R_{thJC} Max. Thermal Resistance Junction to Case (Per Package)	0.35	$^\circ\text{C/W}$	DC operation
R_{thCS} Typical Thermal Resistance, Case to Heatsink	0.10	$^\circ\text{C/W}$	Mounting surface, smooth and greased
wt Approximate Weight	79 (2.80)	g (oz.)	
T Mounting Torque	Min.	24 (20)	Kg-cm (lbf-in)
	Max.	35 (30)	
	Typ.	13.5 (12)	
	Min.	35 (30)	
	Max.	46 (40)	
Case Style	TO-244AB Isolated		Modified JEDEC

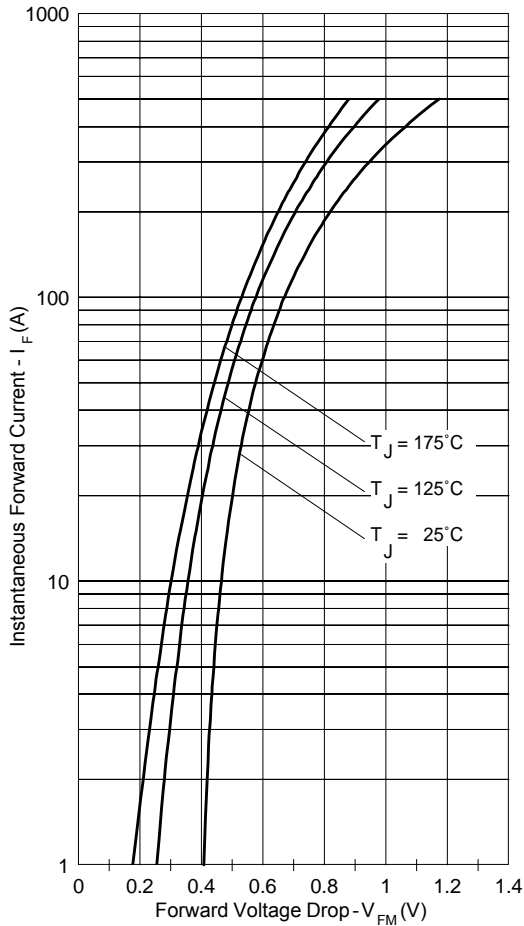

Fig. 1 - Max. Forward Voltage Drop Characteristics

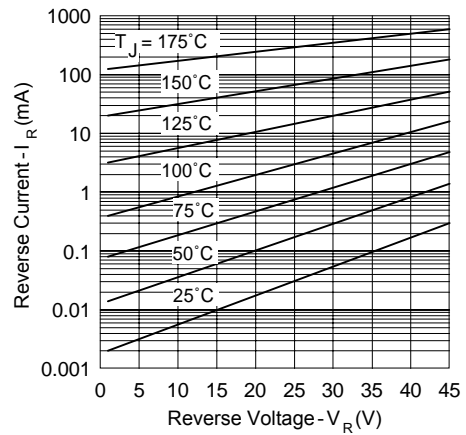

Fig. 2 - Typical Values Of Reverse Current Vs. Reverse Voltage

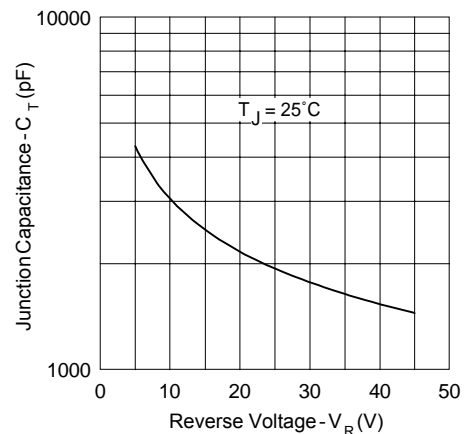

Fig. 3 - Typical Junction Capacitance Vs. Reverse Voltage

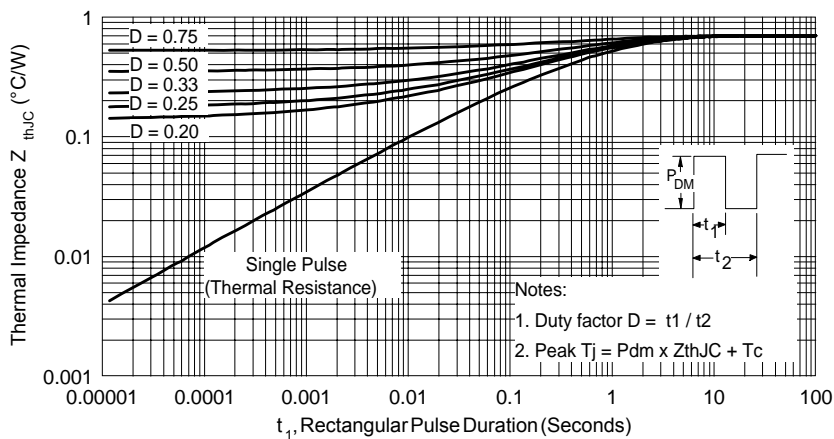

Fig. 4 - Max. Thermal Impedance Z_{thJC} Characteristics (Per Leg)

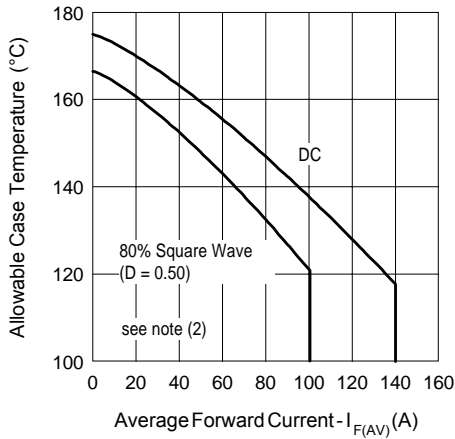

Fig. 5 - Max. Allowable Case Temperature Vs. Average Forward Current

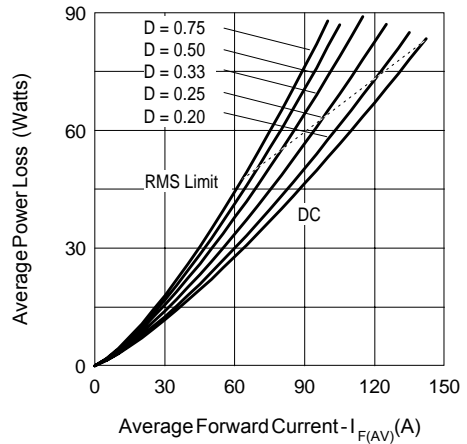

Fig. 6 - Forward Power Loss Characteristics

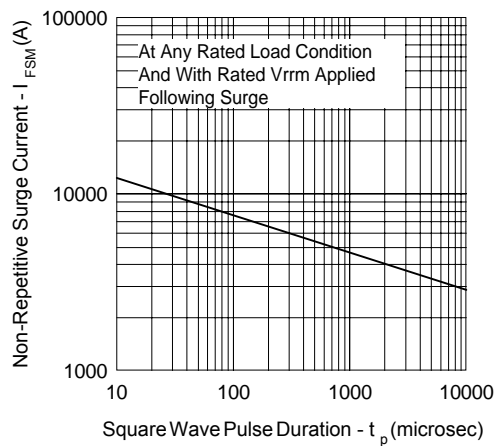

Fig. 7 - Max. Non-Repetitive Surge Current

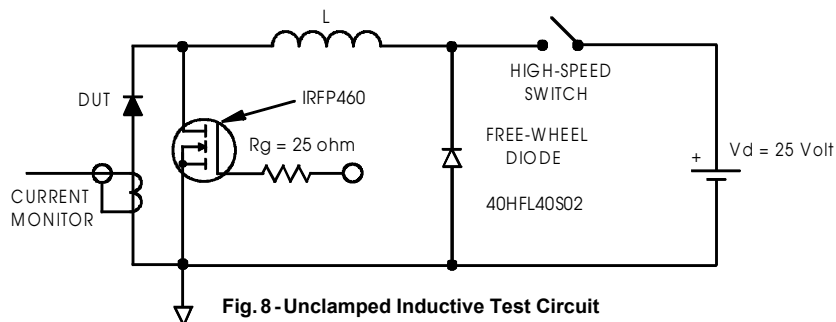

Fig. 8 - Unclamped Inductive Test Circuit

(2) Formula used: $T_c = T_j - (P_d + P_{d_{REV}}) \times R_{thJC}$;

P_d = Forward Power Loss = $I_{F(AV)} \times V_{FM} @ (I_{F(AV)} / D)$ (see Fig. 6);

$P_{d_{REV}}$ = Inverse Power Loss = $V_{R1} \times I_R (1 - D)$; $I_R @ V_{R1} = 80\%$ rated V_R

Ordering Information Table

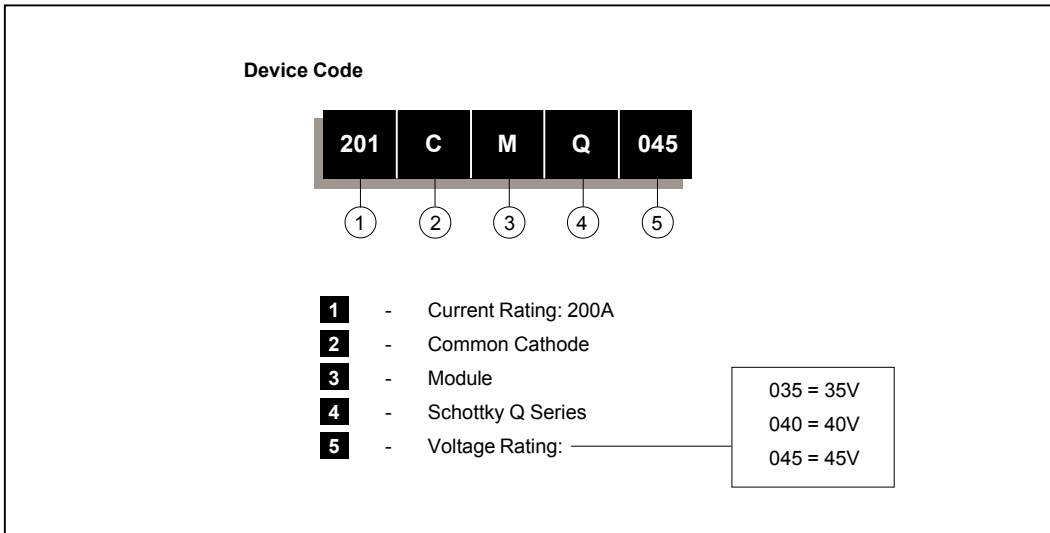

Data and specifications subject to change without notice.
 This product has been designed and qualified for Industrial Level.
 Qualification Standards can be found on IR's Web site.

单击下面可查看定价，库存，交付和生命周期等信息

[>>Vishay\(威世\)](#)